

# Electric spark ignition of sensitive dust clouds in the sub 1 mJ range

by

Erlend Randeberg

*A thesis submitted in partial fulfilment of the requirements  
for the degree of Doctor Scientiarum (dr.scient.)*



Department of Physics and Technology

University of Bergen, Norway

March 2006



# Acknowledgements

This work was conducted at the Department of Physics and Technology, University of Bergen, and I would like to thank everybody who has helped and supported me through this period. Special thanks are due to several people, all of whom have shown interest in the project and offered help and services.

At first, I would like to thank my supervisor, Professor Rolf K. Eckhoff for invaluable help and many fruitful discussions. Without him, I would not have been introduced to the field of dust explosions.

The staff at E-lab deserves many thanks for help in designing and constructing the spark generators and energy measurement system. The effort of Werner Olsen has been essential for this part of the work, and his skills and achievements have been invaluable. I would also thank Per Heradstveit for patiently making new versions of electronic print boards, and Bjørn Pommeresche for many useful tips on LabView programming.

Furthermore, I would thank the staff at the mechanical workshop at the department for showing great patience and creativity when they were repeatedly faced with new ideas and requests. Most of the equipment at the laboratory was made at the workshop by Kåre Slettebakken, Svein Midtun, Leif Egil Sandnes and Øystein Grutle.

Fellow PhD student Trygve Skjold has also been very helpful throughout the project and has contributed with good tips and many useful discussions, as well as showing special interest in the work.

Chemetall GmbH, Swiss Institute of Safety & Security, Carlfors Bruk AB and GexCon AS have supplied some of the dusts used free of charge. GexCon has also lent some useful equipment to the laboratory.

The Research Council of Norway has supported the work financially.



# Abstract

This thesis describes a study of the minimum ignition energy (MIE) of easily ignitable dust clouds in air. The MIE is a central parameter when assessing the risk involved when handling combustible dusts. Current standard test apparatus for determining MIE of dust clouds has a lower energy limit in the range of 1-3 mJ, which is a quite severe limitation because many dusts ignite readily at this energy level. Thus, the true MIE remains unknown for a number of easily ignitable dusts.

A new spark generator, capable of producing synchronised sparks of very low energies and with an integrated system for measuring spark energy, has therefore been developed and applied to a number of ignition sensitive dusts. The experiments showed that several dusts did in fact have MIEs 1-2 orders of magnitude lower than 1 mJ. The new spark generator may therefore offer a basis for developing a standard test apparatus in the low-energy region.

An investigation of a possible spark triggering mechanism that may take place in industrial practice has also been performed, and using this method, MIEs of several dusts were determined. Unlike the conventional method for determining MIE in the laboratory, the delay between dust dispersion and spark discharge was not a degree of freedom. In stead, the transient dust cloud was used to initiate spark breakdown between electrodes set at a high voltage lower than breakdown in pure air. As would be expected, the MIEs found by this method were somewhat higher than those obtained using conventional methods. This was ascribed to the non-optimal conditions for ignition at sparkover, which is believed to be closer to the mechanism of accidental electrostatic spark initiation in an industrial plant. There optimal independent dust dispersion and artificial spark triggering is not a realistic scenario. However, even when using this non-optimal method of spark triggering, MIEs below 1 mJ were found.



# Table of contents

<b>Acknowledgements</b> .....	<b>i</b>
<b>Abstract</b> .....	<b>iii</b>
<b>Table of contents</b> .....	<b>v</b>
<b>1 Introduction</b> .....	<b>1</b>
1.1 Motivation .....	1
1.2 Current standard tests for MIE of dust clouds .....	3
<b>2 Some basic concepts on dust explosions and ignition</b> .....	<b>5</b>
2.1 Explosion .....	5
2.2 Ignition of dust clouds .....	6
2.3 Characteristics of electrostatic spark discharges in air .....	9
<b>3 Generation of synchronised electric sparks and spark energy measurement</b> .....	<b>15</b>
3.1 Spark generation principles used in previous works .....	15
3.2 Spark energy measurement .....	20
3.3 Spark triggering by the explosive dust cloud itself.....	21
3.4 A new spark generator for synchronised low-energy sparks in the < 1 mJ range.....	23
<b>4 Considerations on MIE testing</b> .....	<b>29</b>
4.1 Current standard methods for MIE testing.....	29
4.2 Spark duration and incendivity.....	29
4.3 MIEs obtained using the dust cloud itself as a spark trigger .....	33
4.4 MIEs obtained when using the new spark generator.....	35
4.5 Implications for the industrial handling of dusts with very low MIEs .....	37
4.6 Suggestions for further work .....	38
<b>5 Conclusions</b> .....	<b>41</b>
<b>References</b> .....	<b>43</b>
<b>Appendix A Papers</b> .....	<b>47</b>
A.1 “Initiation of dust explosions by electric spark discharges triggered by the explosive dust cloud itself” .....	49

A.2	“A plausible mechanism for initiation of dust explosions by electrostatic spark discharges in industrial practice” .....	59
A.3	“A new method for generation of synchronised capacitive sparks of low energy” .....	75
A.4	“Measurement of minimum ignition energies of dust clouds in the < 1 mJ region” .....	87
A.5	“Electrostatic spark ignition of sensitive dust clouds of MIE < 1 mJ” .....	111
<b>Appendix B Experimental equipment and procedures .....</b>		<b>123</b>
B.1	Spark generator details .....	123
B.2	Spark energy calculation .....	124
B.3	Experimental procedures.....	125



# 1 Introduction

## 1.1 Motivation

Any solid material that can burn in air will do so with a violence and rate that increase with increasing sub-division of the material. Many materials that are virtually inflammable in bulk form become highly explosive if dispersed as a cloud of fine particles in air. Thus, in industries that manufacture, transport, process and/or use combustible dusts, accidental dust explosions represent a real hazard to both personnel and equipment.

There are two complementary strategies for reducing the risk posed by dust explosions: *prevention* and *mitigation*. Various means for preventing and mitigating dust explosions are listed in Table 1-1.

In risk reduction, attention must be paid to both prevention and mitigation. However, the focus of the present work is on the source of initiation of dust explosions, and more specifically on the lower energy limits of electric sparks that can act as ignition sources for sensitive dust clouds.

**Table 1-1.** Means of preventing and mitigating dust explosions, from Eckhoff [1].

PREVENTION		MITIGATION
Preventing ignition sources, such as:	Preventing explosible dust cloud:	
<ul style="list-style-type: none"><li>• Smouldering combustion in dust, dust flames</li><li>• Other types of open flames (e.g. hot work)</li><li>• Hot surfaces</li><li>• Electric sparks and arcs</li><li>• Electrostatic discharges</li><li>• Heat from mechanical impact (metal sparks and hot-spots)</li></ul>	<ul style="list-style-type: none"><li>• Inerting by N<sub>2</sub>, CO<sub>2</sub> and rare gases</li><li>• Intrinsic inerting</li><li>• Inerting by adding inert dust</li><li>• Dust concentration outside explosible range</li></ul>	<ul style="list-style-type: none"><li>• Partial inerting by inert gas</li><li>• Isolation (sectioning)</li><li>• Venting</li><li>• Pressure resistant construction</li><li>• Automatic suppression</li><li>• Good housekeeping (dust removal/cleaning)</li></ul>

**Table 1-2.** Examples of possible spark energies in industrial practice. From [2].

---

<b>Charged object</b>	<b>Capacitance (pF)</b>	<b>Potential (kV)</b>	<b>Approximate energy (mJ)</b>
Single screw	1	5	0.01
Flange (nominal width 100 mm)	10	10	0.5
Shovel	20	15	2
Small container (~50 litres)	50	8	2
Funnel	50	15	6
Person	300	10	15
Drum (200 litres)	200	20	40
Road tanker	1000	15	100

---

Dust explosions and gas explosions have both similarities and differences. However, in general dust explosions are far more complex than gas explosions. Because of gravitational settling of the particles, quiescent dust clouds are non-existing in practice. Thus, the dynamics of the combustible medium complicates both the ignition process and the subsequent combustion. The chemical process of ignition and combustion is also significantly more complex for dust clouds than for gases. Depending on the material in question, the chemical reaction may involve direct combustion of the solid particles, or initial stages of vaporisation and pyrolysis. The combustion of a dust cloud may therefore involve homogenous as well as heterogeneous reactions.

A central question in the present work is how a dust cloud is ignited by accidental electrostatic sparks in practice in an industrial plant. In such a case, the capacitance between unearthed metal objects and earth, in addition to the charging voltages that can occur, are central parameters. Knowledge of the safe limits with regards to the energies of sparks occurring is essential, and the establishment of maximum acceptable spark energies gives information about e.g. the maximum acceptable size (related to capacitance) of unearthed metal objects. Table 1-2 gives some examples of combinations of capacitances and voltages and resulting theoretical spark energies for typical plant items.

If the MIE of the dust of concern is very small, one must pay attention to even minor plant items, perhaps even a single screw. This may indeed be the case for electrically non-conducting powders, whereas for metal powders fine layers may form on surfaces in contact with the particle cloud and provide

sufficient electrical connection to earth to prevent significant charge build-up on otherwise non-earthed metal items.

## ***1.2 Current standard tests for MIE of dust clouds***

The minimum ignition energy (MIE) is the lowest energy that must be dissipated in an electric spark to ignite a flammable mixture. Thus, the MIE of a dust cloud indicates the lower energy limit of sparks capable of igniting it, and defines the border between “safe” and “unsafe” spark energies.

To establish the MIEs of different dust clouds in air, standard laboratory tests are used [3, 4]. The conventional method of assessing the MIE of a dust cloud starts with the generation of a transient dust cloud by exposing a heap of dust to an air blast. An electric spark is triggered at a point in time after dust dispersion, at which an explosive dust cloud occupies the region of the spark gap. The delay between dust dispersion and sparkover is adjusted to optimise dust concentration and turbulence at the time of ignition.

Due to the technical problems in generating low-energy sparks that can be synchronised with the dust dispersion, the lower energy limit of the sparks that can be provided by current standard apparatus is about 1-3 mJ. This implies that MIEs of dust clouds having their true values below 1 mJ are not available, the spark ignition sensitivities of a number of dusts being simply specified as  $MIE < 1 \text{ mJ}$ .

However, it is well known that clouds in air of many powders/dusts ignite quite readily when exposed to the smallest spark energies that current apparatuses can provide. Using equipment different from the standard apparatus – but without giving any details of the method of spark generation and energy measurement – Bartknecht [5] reported MIE for aluminium of 0.1 mJ and for sulphur of 0.01 mJ.

Even so, resolving MIEs in the sub 1 mJ range does not seem to be an issue. However, in the context of the electrostatic spark ignition hazard it is not easy to comprehend this approach. If the MIE is in fact considerably lower than 1 mJ, even minor electrically conducting objects may give rise to incendiary spark discharges. Alternatively, lower voltages than commonly believed may give rise to such discharges. Hence, it is indeed important to be

able to determine the true MIE even in the sub 1 mJ range, in particular with electrically non-conductive powders.

In the present work, focus has been on the following aspects related to the assessment of MIEs of ignition sensitive dust clouds:

- 1) Development of a generator capable of producing electric sparks of energies  $\ll 1$  mJ that can be synchronised with the appearance of the transient dust cloud.
- 2) Application of the spark generator to a selection of ignition sensitive powders.
- 3) Investigation of a possible spark triggering mechanism that may take place in industrial practice, viz. the appearance of the dust cloud in the spark gap triggering the spark discharge.
- 4) Determination of MIEs using the explosive dust cloud itself as the method of spark triggering.

## 2 Some basic concepts on dust explosions and ignition

In this chapter, some basic concepts related to dust explosions and ignition are briefly introduced. For a more general overview of the phenomena of dust explosions, the reader should consult some of the available textbooks, e.g. [1, 5].

### 2.1 Explosion

The most evident feature of an explosion is a rapid increase in pressure. In order for an explosion to occur, there must therefore be accumulated energy, which can be released suddenly to produce a pressure wave. Explosions can be classified according to the origin of the released energy: *physical* (e.g. bursting of a pressurised vessel), *chemical* (e.g. rapid combustion) or *nuclear* (fusion or fission). Only chemical explosions are treated in this work.

When disregarding rapid chemical reactions involving explosives and chemically unstable substances, five basic requirements for chemical explosions must be fulfilled:

- 1) *Fuel* – a combustible gas, vapour, mist or dust cloud.
- 2) *Oxidiser* – usually air (oxygen).
- 3) *Combustible mixture ratio* of fuel and oxidiser.
- 4) *Confinement*. Some degree of confinement is usually necessary for pressure build-up, depending on the rate of the chemical reactions. According to the degree of confinement, explosions can be classified as *unconfined*, *partially confined* and *constant volume*.
- 5) *Ignition source*.

A *dust explosion* can be defined as the rapid combustion of a combustible dust cloud, resulting in rapid increase in temperature and pressure. The dust

can be any finely divided combustible solid material, with particle diameter typically below 100-200  $\mu\text{m}$ . In general, the combustion rate increases with decreasing particle size, down to some limiting particle size depending on the type of dust material. In addition, the concentration of the fuel must be within the explosive limits. For an optimum concentration, the energy necessary for ignition reaches its minimum value.

## ***2.2 Ignition of dust clouds***

### ***2.2.1 What is ignition?***

Babrauskas [6] states that “The definition of ignition is often a source of rich controversy to theoreticians (...). Experimentalists generally do not face this difficulty, it being visually clear whether a substance is ignited or not”. In the present work, the experimentalist’s point of view is adopted, eliminating the need for a rigorous discussion of the concept of ignition.

Even so, a simple definition of ignition can be “the process by which propagation of a self-sustained combustion or exothermal decomposition wave is initiated” [1]. The concept is thus only meaningful when applied to systems with substances that can react exothermically.

For a combustible system to ignite, the heat production rate within the ignition zone must exceed the heat loss rate from this zone by conduction, convection and radiation.

### ***2.2.2 Conditions for ignition of dust clouds***

In a hazard evaluation, the stochastic nature of the ignition process is a source of error if the investigation does not involve a sufficient amount of trials. If one performs only a few experiments and obtains a negative result, this can mean that 1) the event is indeed impossible; or 2) the investigator was either not clever or patient enough to discover the specific circumstances under which the event actually occurs.

Many ignition phenomena have a strong probabilistic aspect to them – if the probability of ignition is low and only a few experiments are done, one may erratically conclude that ignition is impossible. Also, if the experimental conditions have not been optimised to favour ignition, erratic conclusions can

be drawn [6]. Therefore, attention should be paid to the experimental methods used, the level of optimisation involved, the number of replicate experiments performed to establish a probability of ignition and last but not least, the probability selected for deciding the critical threshold for ignition. By systematically investigating the frequency of ignition as a function of the strength of the ignition source, additional insight may be achieved than through more arbitrary testing.

### 2.2.3 Ignition sources

Lüttgens and Wilson [7] distinguish between 13 different ignition sources, listed in Table 2-1. The classification may seem somewhat arbitrary for several reasons, e.g.:

1. Flames (2) are the result of exothermic chemical reactions (13).
2. Lightning (7) is an electrostatic discharge (6).
3. Electrical equipment (4) may include e.g. hot surfaces (1).
4. Electromagnetic radiation is appearing in several categories (8-10).

**Table 2-1.** Classification of ignition sources by Lüttgens and Wilson [7].

No.	Ignition source	Example
1	Hot surface	Heating pipe; casing of an electrical apparatus
2	Flames and hot gases	Autogeneous welding; exhaust gases
3	Mechanical sparks	Abrasive cutting; flint gas lighter
4	Electrical equipment	Electrical sparks at make and break
5	Cathodic protection against corrosion, transient current	Sneak current; short circuit to earth
6	Static electricity	Spark discharge; brush discharge
7	Lightning stroke	
8	Electromagnetic waves (high frequency range)	Induction heating; radiotelephone
9	Electromagnetic waves (optical range)	Photoflash; laser
10	Ionising radiation	X-rays; UV-rays
11	Ultrasonics	Ultrasonic cleaning; ultrasonic testing
12	Adiabatic compression	Heat of compression; drift wave
13	Chemical reaction	Exothermic process

Babrauskas [6], on the other hand, separate the possible ignition sources for dust clouds into the following five categories:

- Open flames
- Hot surfaces
- Hot particles
- Friction, grinding sparks, or impact sparks
- Sparks from electric devices, including electrostatic discharge

In the present work, emphasis is placed on the electric spark as an ignition source, and more specifically the minimum ignition energy required for ignition of dust clouds in air.

Babrauskas [6] distinguishes between discharges of static electricity depending on the geometries involved:

- Discharge between two conductive electrodes.
- Discharge involving one conductive electrode and a diffuse insulating medium.
- Discharge from one mist or cloud to another.

More specifically, electrostatic discharges can furthermore be separated into the following categories [6]:

1. *Corona discharge*<sup>\*</sup> – too feeble to ignite dust clouds (and most gases)
2. *Brush discharge* – cannot ignite dust clouds in air, but some flammable gas/air mixtures and hybrid dust/gas mixtures can be ignited
3. *Powder heap discharge*<sup>†</sup> – can ignite clouds in air of most combustible dusts
4. *Spark discharge* – can ignite combustible dust clouds
5. *Propagating brush discharge*<sup>‡</sup> – can ignite most combustible dust clouds
6. *Lightning-like discharge* – hypothetical; could conceivably ignite giant dust clouds

In the present work, only ignition by spark discharges has been considered.

---

<sup>\*</sup> Sometimes called *point discharge*.

<sup>†</sup> Also called *cone discharge* or *bulking discharge*.

<sup>‡</sup> Also called *Lichtenberg discharge*.



## 2.3 Characteristics of electrostatic spark discharges in air

### 2.3.1 General

When considering electrostatic spark discharges as an ignition source for dust clouds, some important characteristics of such discharges in air should be addressed. Some concepts regarding discharge phenomena related to electrical breakdown of short gaps in air, with a subsequent arc or glow discharge, are therefore introduced in this section. Comprehensive treatment of electrical discharges in gases can be found in a number of books, e.g. [8-11]. Electrostatic discharges specifically are described in e.g. [2, 7, 12].

The term *spark* can be defined as a disruptive discharge through a single ionisation channel that bridges the gap between two conductive electrodes (e.g. [2]). A distinction can be made between *electrical sparks* (or *break sparks*) formed by the breaking of low-voltage high-current circuits, and *electrostatic sparks* being a high-voltage low-current phenomenon occurring when the electric field is sufficiently high to cause electrical breakdown of the prevailing gas between the two electrodes [12].

### 2.3.2 Conditions for spark generation

An electric spark discharge occurs through the air separating the two electrodes when the electric field reaches a value of approximately 3 kV/mm (e.g. [7]). Thus, for a gap distance of 2 mm, the voltage required for achieving breakdown of a uniform electric field is of the order of 6 kV. With non-uniform fields, which are present when the electrodes are pointed, the breakdown voltages are somewhat lower.

The breakdown voltage of a uniform field is proportional to the product of pressure and gap length for a particular gas and electrode material (*Paschen's law*). For non-uniform fields, however, the situation is more complicated. The breakdown voltage for short gaps with thin electrodes is found to be proportional to the square root of the gap length [13]. In non-uniform fields, the *streamer mechanism* plays an important part, and various luminous and audible corona discharges can be observed before the complete breakdown [11]. The first streamer may initiate breakdown, or it may lead to the

establishment of a steady-state corona that stabilises the gap against breakdown.

### ***2.3.3 Properties of spark discharges***

The ignition is strongly influenced by the discharge mode and the geometry of the plasma volume, in addition to the total energy involved [14]. The energy used in the ignition process in a spark-ignition engine is only the fraction transferred to the narrow interface layer at the surface of the plasma, which has a thickness of the order of the flame front [15]. A thorough description of the characteristics of the discharge phases, with representative values of some of the physical parameters, is given in [16, 17].

Typical voltage and current vs. time in a spark discharge is shown in Figure 2-1. The six phases of the discharge can briefly be described as follows, with reference to [16], unless otherwise stated.

- i) Pre-breakdown phase.* Initially, the air between the electrodes represents a near perfect insulator (the conduction in air at low field strength is in the order of  $10^{-16}$  -  $10^{-17}$  A/cm<sup>2</sup> [11]). When the electric field is increased, free *primary electrons* are accelerated towards the anode, and these electrons can ionise neutral gas molecules (*electron collision*), generating additional *secondary electrons* and ions. Atoms in the gas may become excited by collisions with electrons of lower energies than the ionisation energy, which can produce UV radiation that can ionise other atoms (*photoionisation*). The origin of the electron avalanches can thus move closer to the cathode, and eventually positive ions are generated sufficiently close to the cathode to be accelerated towards it. Electrons may be liberated from the cathode surface, triggering a positive feedback loop. The number of electrons and ions increase rapidly (*avalanche*) and conducting channels (*streamers*) are formed. The pre-breakdown phase lasts as long as the ionising processes produce fewer electrons than required for rendering the discharge self-sustained, determined by the rate of rise of gap voltage.

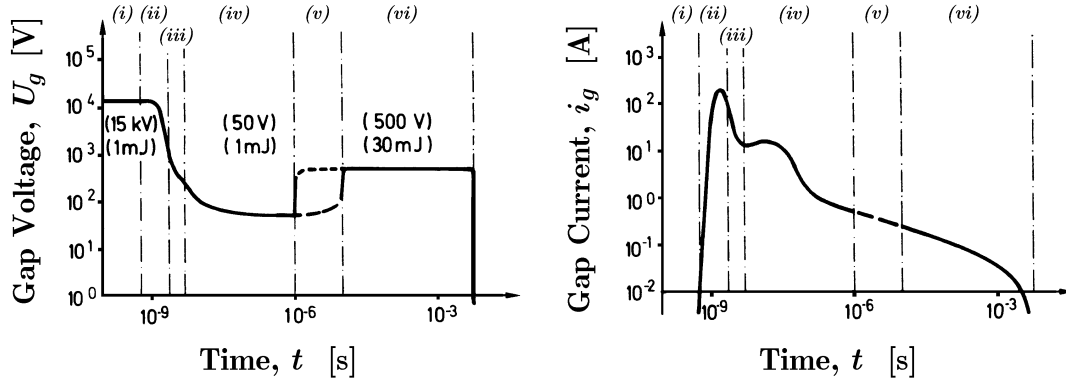

**Figure 2-1.** Schematic diagrams of voltage and current as functions of time during a discharge of typical spark ignition systems, illustrating the six basic discharge phases: (i) *pre-discharge*, (ii) *breakdown*, (iii) *breakdown/arc transition*, (iv) *arc*, (v) *arc/glow transition*, and (vi) *glow*. The actual values depend on the electrical components of the discharge circuit; some typical values are given in parenthesis. From [14].

- ii) *Breakdown phase.* When enough feedback electrons are produced, the discharge current increases dramatically from  $\sim 10$  mA to  $\sim 200$  A during  $\sim 1$ - $10$  ns. At the same time, the voltage drops rapidly from  $\sim 10$  kV to  $\sim 100$  V; hence the term *breakdown*. The impedance of the discharge circuit is the only factor limiting the current during the breakdown phase. The electrical energy of the circuit is transferred very efficiently via the electrical field to the electrons and the ions, and consequently the temperature and pressure rises rapidly (to  $\sim 60$  000 K and  $\sim 200$  bar), resulting in the emission of a shock wave. About 30 percent of the energy is carried by the shock wave, heating the surrounding gas within a rather small sphere ( $\sim 1$  mm). The overall energy transfer efficiency of the breakdown phase is very high.
- iii) *Breakdown/arc transition.* Application of a sufficiently strong electric field ( $\sim 10^9$ - $10^{10}$  V/m) can cause tunnelling of electrons from the surface of a metal [11]. Prolonged duration of a high-current flow thus leads to thermionic emission from hot cathode spots, indicating the end of the breakdown phase and the start of the arc regime.
- iv) *Arc phase.* Electrons emitted from hot cathode spots (pools of melted electrode material,  $10$ - $40$   $\mu\text{m}$  in diameter) are required to sustain the arc. The gap voltage is quite low ( $\sim 50$  V), and the current may be as high as the impedance of the external circuit permits (from  $\sim 0.5$  A to

several kA). The equilibrium kernel gas temperature is limited to ~6000 K. Mainly because of energy losses to the electrodes, the energy transfer of the arc is moderate – about 50 percent of the electric energy is transferred to the plasma. The arc represents an almost purely thermal character with the consequence that energy transfer to the plasma is by heat conduction and mass diffusion rather than by overpressure.

- v) *Arc/glow transition.* When the cathode cools down, the glow phase is building up. At currents of 100-200 mA, the discharge tends to oscillate between glow and arc. The discharge can be forced into glow by limiting the current.
- vi) *Glow phase.* Feedback electrons are liberated from the cathode by ion impact during the glow phase. Currents of less than ~100 mA, a cold cathode, less than 0.01 percent ionisation and equilibrium kernel gas temperature of ~3000 K are typical. A large fraction (~70 percent) of the supplied energy is lost to the electrodes.

Any spark ignition system comprises different combinations of the three discharge modes (breakdown, arc and glow), with varying energy and discharge durations. Low impedance (e.g. capacitive discharge circuit) favours arc discharge, whereas high impedance (e.g. discharge circuits with series resistance or inductance) favours glow discharge.

#### ***2.3.4 Characteristics of electric spark discharges influencing the ignitability of explosive dust clouds***

The typical energy balances for the different discharge phases are summarised in Table 2-2, showing that the breakdown phase is by far the most efficient when it comes to transferring the electric energy to the spark plasma. In addition to the total energy transferred to the spark, also the rate of energy supply is of significant importance for the incendivity of the spark.

**Table 2-2.** Energy balance for breakdown, arc and glow discharge plasmas under idealised conditions (small electrodes) [16].

	<i>Breakdown</i> (%)	<i>Arc discharge</i> (%)	<i>Glow discharge</i> (%)
Radiation loss	< 1	ca. 5	< 1
Heat conduction via electrodes	ca. 5	ca. 45	70
Total losses	ca. 6	ca. 50	ca. 70
Total plasma	ca. 94	ca. 50	ca. 30

The development of flames succeeding spark ignition is described in [16]. A few nanoseconds after spark onset (i.e. during the breakdown phase) chemical reactions can be observed (e.g. formation of CN). These reactions are initiated by the extremely high radical density in the breakdown plasma where all the heavy particles N, O, H, C are present as highly excited atoms and ions. As the kernel temperatures are still much too high to allow stable molecules to exist, these reactions can only take place at the low-temperature end of the plasma surface. However, irrespective of the interior conditions and the expansion velocity of the physical plasma, there will always be a reaction zone at the plasma surface where a sufficient temperature level ( $< 8000$  K) offers ideal conditions for very intense chemical activities. As arc and glow discharges supply heat mainly by heat conduction from the spark axis, the possible increase in reaction rates is less effective than in breakdown plasmas where most heat is carried by radicals.

Due to the high temperature, a layer of highly reactive radicals is formed at the surface of the spark plasma, giving rise to a growing flame kernel. A few hundred  $\mu$ s after breakdown the surface temperature has dropped below 3000 K [14], and the description of high-temperature combustion of e.g. hydrocarbons can be applied [18]. Inflammation from spark ignition is thought to be possible only with formation of a critical flame kernel, or minimum flame sphere to support a combustion temperature. The growth of such a flame kernel in spark-ignited propane-air mixtures has been investigated by e.g. [19-21].

As pointed out by [14], the spark energy is indeed not the only important parameter for ignition. Particularly the discharge duration plays an important

role with regards to the spark's ability to ignite both explosive gases and dust clouds. This aspect is addressed in greater detail in Section 4.2.

# 3 Generation of synchronised electric sparks and spark energy measurement

## 3.1 Spark generation principles used in previous works

As mentioned in Section 2.3.1, a distinction can be made between electrical and electrostatic sparks. An electrical spark is a low-voltage high-current phenomenon, and the energy available for the spark is stored in the magnetic field associated with the inductance  $L$  of the electrical circuit and the current  $I$ ,

$$E = \frac{1}{2}LI^2. \quad (3.1)$$

The energy is in electrokinetic form, and the spark occurs when the current is broken, for example in a switch or in an electrical engine. Such sparks are often referred to as *break sparks*.

If the spark is caused by the release of electrical charge stored on a capacitor with a capacitance  $C$  and voltage  $V$ , the energy available for the spark is given by

$$E = \frac{1}{2}CV^2. \quad (3.2)$$

The capacitor energy is in electrostatic form, and the spark occurs when the voltage reaches the breakdown voltage of the spark gap. Sparks generated this way are also called *jump sparks*.

The break spark is usually considered the less useful for ignition studies [22], and in standard test apparatus for determination of MIE of dust clouds, only jump sparks are employed [3].

Instead of using a single capacitor for energy storage, various systems using pulse-forming networks have been employed. High-voltage equipment such as thyratrons have been used to control the time of breakdown and the duration of the discharge.

A number of circuits have been used for generating electric sparks for gas and dust ignition. When working with quiescent gases, precise timing of the

spark is not crucial. On the other hand, because of gravitational settling of the dust particles, precise synchronisation between dust dispersion and sparkover is necessary in order to optimise dust concentration and turbulence. Thus, when the spark is used as an ignition source for dust clouds, attention must be paid to the method of synchronisation.

The spark generation systems available when designing current standard apparatuses for investigation of MIE of dust clouds should, according to [3], be the following:

1. *Spark triggering by the use of a high-voltage relay:* The schematic layout of the circuit is given in Figure 3-1. For low energies, the unavoidable stray capacitance of the electrode arrangement and relay is of the same order of magnitude as the storage capacitor, i.e. some pF, and must be taken into account when calculating the energy stored in the circuit prior to discharge. Very low energies are thus difficult to achieve with this arrangement. In addition, energy losses in the relay may be of importance.
2. *Spark triggering by voltage increase, using a high-voltage switch for slow charging of a capacitor through a large resistor:* The schematic layout is shown in Figure 3-2. The voltage at the time of breakdown is measured by an electrostatic voltmeter, which also may introduce a certain stray capacitance. Precise synchronisation of the spark and dust dispersion can be difficult to achieve due to the charging time of the capacitor before discharge. Continuous charging of the storage capacitor may also cause a problem of multiple sparks within the time frame of the dust dispersion, especially at low capacitances when the time constant  $RC$  is small. To be able to generate single sparks of low energies, impractically high resistor values ( $\sim 10^{11} \Omega$ ) must be used.
3. *Spark triggering by electrode movement:* The schematic layout of the circuit is given in Figure 3-3. The storage capacitor is charged to a high-voltage with the electrode gap so wide that breakdown is beyond reach. After opening of the charging relay, the earthed electrode is moved rapidly by a pneumatic or spring-driven system. Sparkover occurs at an unknown gap distance, corresponding to the field strength at



breakdown. Corona current flowing from the electrode tips prior to breakdown may constitute a significant part of the stored energy at low energies, and the method is thus not ideal for low energies.

4. *Spark triggering by an auxiliary spark achieved using a three-electrode system:* The schematic layout is given in Figure 3-4. A storage capacitor is charged to a high-voltage, somewhat below breakdown. After closing the charging relay, an auxiliary spark of low energy is triggered, causing breakdown between the main electrodes. Corona current may cause energy losses, which can be significant at low energies. In addition, at low energies, the energy supplied by the auxiliary spark will usually be substantial compared to the stored capacitor energy in the primary circuit, because the auxiliary spark must be energetic enough for ionisation of the gap.

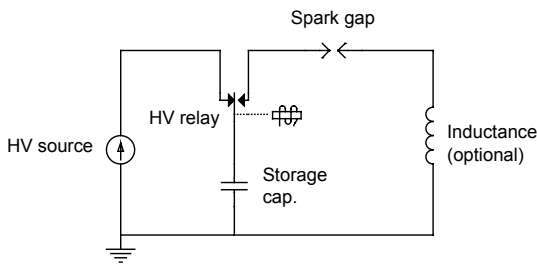

**Figure 3-1.** Discharge system using a high-voltage relay as the method of triggering. A spark is generated by triggering the relay and discharging the storage capacitor.

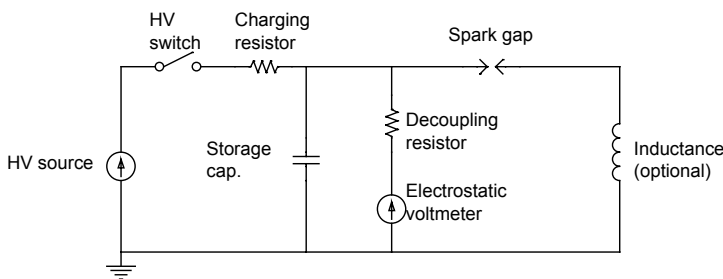

**Figure 3-2.** Discharge system based on voltage increase. By closing the switch, the capacitor is charged through a charging resistor until the breakdown voltage is reached.

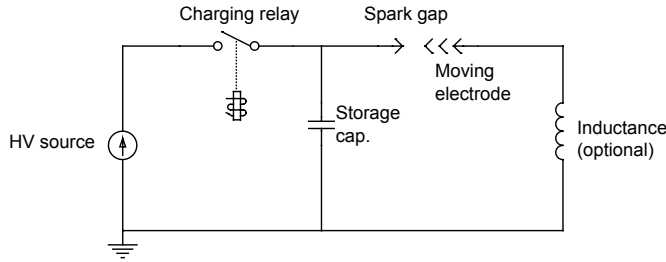

**Figure 3-3.** Discharge system using electrode movement as the method of triggering. A spark is generated by reducing the gap when the storage capacitor is charged to a high-voltage.

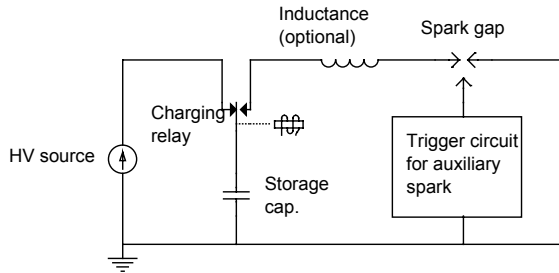

**Figure 3-4.** Discharge system using a three-electrode system. The storage capacitor is discharged subsequently of the triggering of the auxiliary spark used for ionising the spark gap.

5. *Spark triggering by the use of a high-voltage transformer:* The schematic layout of a typical circuit is shown in Figure 3-5. A triggering capacitor charged at a low voltage is discharged through a high-voltage transformer, generating a high-voltage pulse. After breakdown, the main capacitor, initially charged to a voltage in the range of 500 V, is discharged in the spark gap. The diode's function is to prevent oscillations during discharge, thus attaining discharge characteristics similar to those of an over damped  $RC$  discharge. The lower limit of the spark energy that can be produced by this circuit is the energy of the triggering capacitor prior to breakdown, which has to be at least a few mJ.

In addition, the following spark generation methods have been used or can be used for MIE testing of dust clouds:

6. *Spark triggering by irradiation of the electrode gap:* This method is similar to the three-electrode system (4), using highly energetic

radiation to ionise the electrode gap instead of an auxiliary spark, and the limitations are the same. The opaqueness of dust clouds also causes problems.

7. *Spark triggering by using a moving capacitor plate device:* The schematic layout is shown in Figure 3-6, and the circuit is described in further detail in [23]. With one electrode charged to a high-voltage below breakdown, a spark is triggered when the spring-loaded capacitor plate is moved from its initial “closed” position. The amount of energy released can be calculated by assuming conservation of the charge on the capacitor. This method of spark triggering has not been employed to dust explosions, but investigations of the MIE of gases is described in [24]. The spark energies reported for gases are relatively low; down to about 0.4 mJ. It is probably possible to develop this method also for dust clouds, but there are some challenges concerning precise energy measurement at very low energies. Accurate timing of the spark may also be a challenge.
8. *Spark triggering methods involving complex high-voltage circuit elements like thyratrons:* Pulse forming networks may be used to generate sparks of specified duration and voltage [22, 25-27]. Very low energies have been achieved using this kind of high-voltage equipment. However, working with such equipment offers significant technical challenges, and the sparks obtained may be quite “exotic” compared to the sparks occurring in industrial practice.

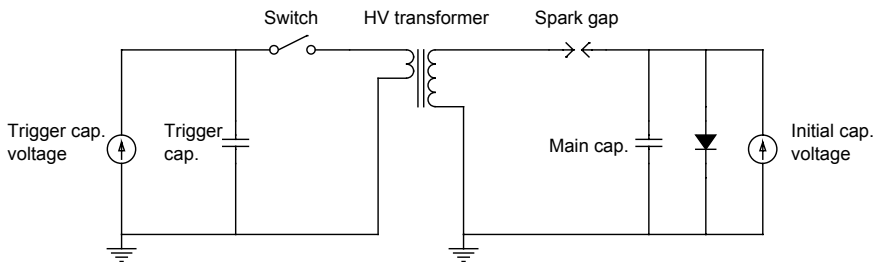

**Figure 3-5.** Discharge system with high-voltage transformer. A high-voltage pulse is generated by closing the switch, causing breakdown and subsequent discharging of the main capacitor.

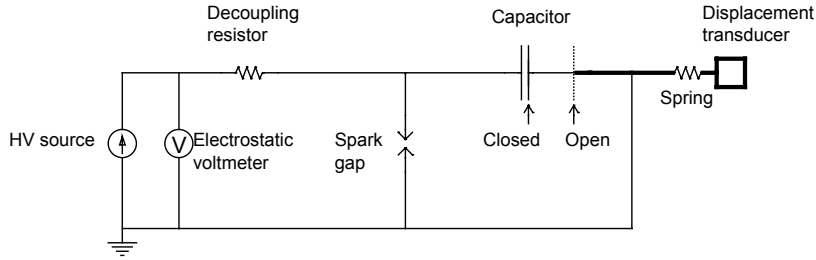

**Figure 3-6.** Discharge system with a moving capacitor plate device. The capacitor is initially charged to a high-voltage below breakdown, with the capacitor plates in the “closed” position. The movable plate can be spring opened, and its position determined by means of the displacement transducer.

When investigating the ignition energies of easily ignitable dusts, especially in the context of related electrostatic hazards, it is essential to be able to generate synchronised sparks in the energy range below 1 mJ. All spark generation designs described above have limitations when it comes to one or several of the following desired features:

- Precise synchronisation between dust dispersion and spark onset must be available.
- The energy losses must be either negligible or taken into account when calculating the spark energy.
- The sparks produced should be as similar as possible to purely capacitive electrostatic discharges.

### **3.2 Spark energy measurement**

Precise measurement or estimation of spark energies is essential when determining the MIE of dust clouds. A distinction can be made between measurement of gross capacitor energy prior to breakdown and integration of spark power versus time.

In the former case, the energy is simply assumed equal to the difference between stored capacitor energy before and after the discharge:

$$E = \frac{1}{2}C(V_B^2 - V_A^2),$$

where  $C$  is the capacitance,  $V_B$  is the capacitor voltage before discharge and  $V_A$  is the voltage after discharge. Usually,  $V_B \gg V_A$ , and thus the energy can be approximated by

$$E \simeq \frac{1}{2}CV_B^2, \tag{3.3}$$

in accordance with Equation (3.2). Whether the spark energy can be accurately estimated by this simple expression depends on the characteristics of the discharge circuit. If the discharge circuit contains resistive elements in series with the spark, some of the energy is inevitably lost, and not delivered to the spark. Even so, the gross capacitor energy is used to estimate the spark energy in conventional MIE tests for dust clouds [3, 4]. Thus, energy lost in the electric circuit, to the electrodes, through corona and radiation is disregarded when stating the spark energy.

When estimating the spark energy purely based on stored capacitor energy, little information about the discharge characteristics, e.g. spark duration and current and voltage waveforms, is obtained. When measurements of circuit variables are made, the energy can be calculated from the integral of the power, i.e. the product of voltage  $v$  and current  $i$  of the spark, over the duration of the discharge:

$$E = \int v i dt. \quad (3.4)$$

Thus, only the energy delivered to the spark is found, and circuit capacitance and losses are implicit. A major challenge to this approach is the fact that the different spark phases (e.g. breakdown, arc and glow – see also Section 2.3) have durations differing by orders of magnitude, and the currents and voltages are varying by orders of magnitude in the different phases.

The energy delivered to the spark may alternatively be estimated by subtracting the resistive losses from the stored capacitor energy [28]:

$$E = \frac{1}{2} CV_B^2 - \int R i^2 dt, \quad (3.5)$$

where  $R$  is the circuit resistance in series with the spark gap. Only the current flowing through the spark is measured, eliminating the need for voltage measurements. Further details concerning spark energy measurement and calculation are discussed by Randeberg *et al.* [29].

### ***3.3 Spark triggering by the explosive dust cloud itself***

Due to tribo-electric charging, non-earthed metal objects in industrial plants may obtain voltages of several kV [2, 7, 12]. As long as the field strength is within the limits of breakdown of the dielectric medium (usually air) between the objects acting as electrodes, electric discharges will not occur.

However, disturbance of the electric field can initiate breakdown and subsequent sparkover. Dust particles may therefore act as “spark-triggers”, as described in further detail by Randeberg and Eckhoff [30, 31].

When using the dust cloud to trigger the electric discharge, a very simple discharge circuit has been employed, as shown in Figure 3-7. The voltage was preset at a static high-voltage somewhat below breakdown in pure air, and a spark discharge was triggered when dust was dispersed between the electrodes.

The spark energy was assumed equal to the stored capacitor energy prior to breakdown ( $\frac{1}{2}CV^2$ ). Therefore, it was important to employ very small capacitors in order to achieve low energies, and the stray capacitance of the circuit had to be taken into account. However, the lower energy limit that can be attained by this method whilst ensuring only single sparks during the lifetime of the transient dust cloud is in practice restricted mainly by the charging resistor. Spark energies down to about 0.1 mJ can be achieved with capacitance values of about 10 pF and narrow electrode gaps (i.e. breakdown voltage of about 5 kV). However, charging resistances of about 10 G $\Omega$  must be employed in order to avoid multiple sparking. Thus, if even lower capacitance values are to be used, very large – and possibly impractical – charging resistances must be employed. This energy limitation is similar to what is described for spark generation principle 2 in Section 3.1.

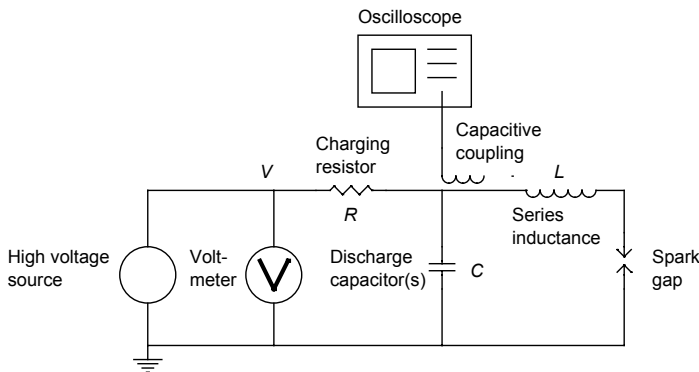

**Figure 3-7.** Schematic layout of the electric discharge circuit. The voltmeter is integrated in the high-voltage source, measuring the output voltage  $V$ . The series inductance  $L$  is used for prolonging the spark and is not included when studying pure capacitive discharges.

### 3.4 A new spark generator for synchronised low-energy sparks in the $< 1$ mJ range

In order to produce sparks of very low energies that can be synchronised with transient dust clouds, a new spark generator was developed by Randeberg *et al.* [29]. The schematic layout of the circuit is shown in Figure 3-8.

The circuit operates in two steps; 1) the generation of a high-voltage pulse, and 2) the subsequent spark discharge of a capacitor charged by this pulse. By triggering a thyristor, a high-voltage pulse with amplitude of about 15 kV is generated by discharging a primary capacitor of 1  $\mu$ F, initially charged at about 300 V, through a high-voltage transformer<sup>§</sup>. The energy stored on the primary capacitor is about 45 mJ, which indicates a theoretical upper energy limit of the generator. However, losses in the transformer and charging resistor must be taken into account, causing the actual upper energy limit to be significantly lower. If the 1  $\mu$ F primary capacitor is not large enough to ensure that the discharge capacitor reaches breakdown, a larger primary capacitance value must be chosen.

The high-voltage pulse has a rise-time of about 0.7 ms, and it is fed through a charging resistor, causing a voltage build-up on the discharge capacitor placed downstream of the charging resistor, close to the spark gap. Discharge of the discharge capacitor occurs when the breakdown voltage of the electrode gap is reached. Thus, precise synchronisation between dust dispersion and sparkover is possible with an accuracy of about 1 ms.

---

<sup>§</sup> A simple coil intended for spark ignition in automobile engines was chosen.

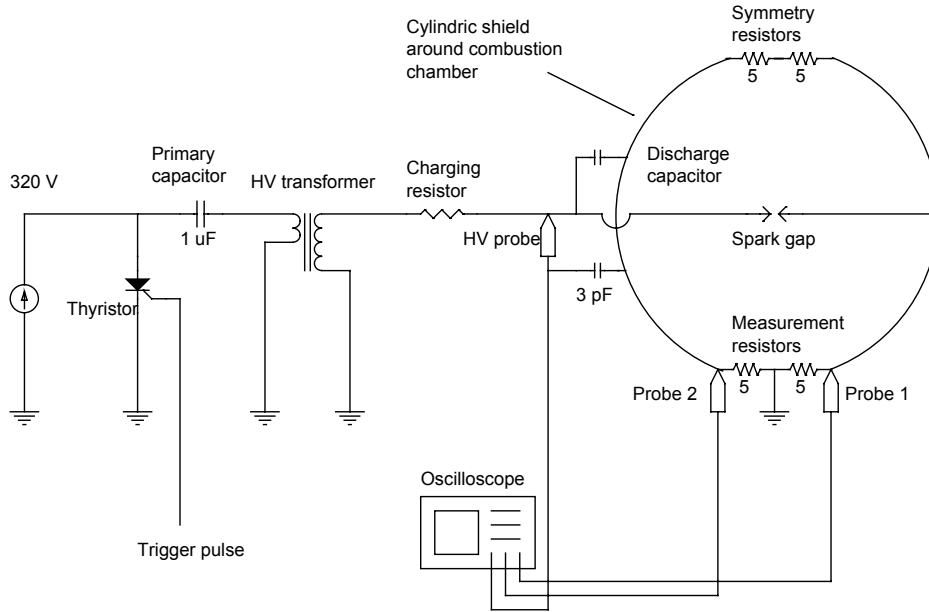

**Figure 3-8.** Schematic layout of a spark discharge circuit with an integrated spark energy measurement system. By triggering of the thyristor, sparks that can be synchronised with the dust dispersion are generated. Further details about the generator are given in [29].

The choice of charging resistor depends on the size of the discharge capacitor, the aim being to avoid recharging of the discharge capacitor during the duration of the discharge. This was achieved by choosing a charging resistor that gave a time constant  $RC$  (where  $R$  is the charging resistance and  $C$  the discharge capacitance) of at least  $1 \mu\text{s}$ , which ensured insignificant recharging of the discharge capacitor during the spark discharge. However, if the charging resistor was too large (i.e. large time constant and long charging time), the spark gap voltage would not reach breakdown during the lifetime of the transient dust cloud.

A system for measurement of spark voltage and current was included in the discharge circuit, enabling measurement of spark energy according to Equation (3.4). In order to calculate the net spark energy  $E_s$ , the energy lost to the measurement resistors was subtracted according to the following expression:

$$E_s = \int v i dt - \int R_M i^2 dt \quad (3.6)$$

where  $R_M = 5 \Omega$  is the total resistance of the measurement resistors and the symmetry resistors.



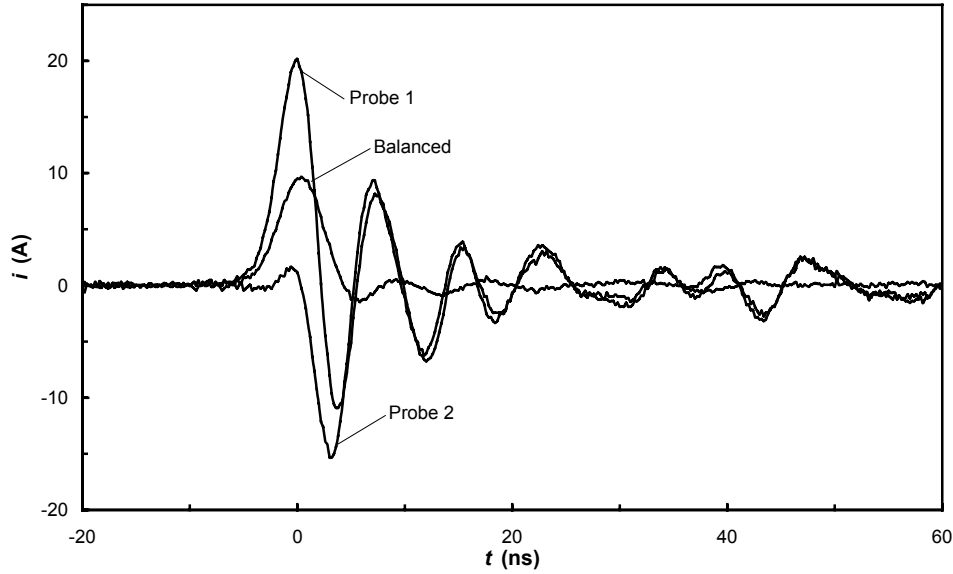
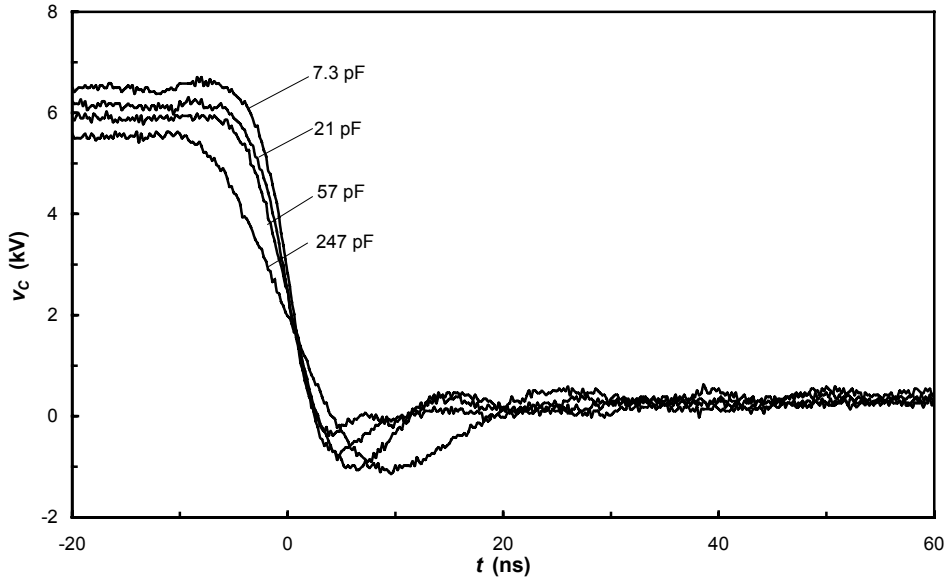

**Figure 3-9.** Illustration of the effect of using balanced current measurements. The balanced signal is the average of two signals of different polarity, thus obtaining significant reduction of the common noise. The circuit capacitance is 7.3 pF and the electrode gap 4 mm.

In order to reduce the influence of noise, current was measured differentially, by two conventional passive scope probes. The effect of this is illustrated in Figure 3-9, showing that the common mode noise was effectively reduced. The effect was especially pronounced for low spark energies.

The current was measured as the voltage drop over several surface mounted resistors with an overall resistance of 5  $\Omega$ . Because of the symmetry resistors on the opposite side of the cylindrical shield around the combustion chamber, the effective measurement resistance was 2.5  $\Omega$  on each probe.

Voltage was measured with a high-voltage probe placed at the high-voltage electrode and with its earth cable attached to the shield, as shown in Figure 3-8. The 3.0 pF probe capacitance thus adds to the discharge capacitance in parallel, and must be taken into account when estimating the total capacitance involved in the discharge.



**Figure 3-10.** Measured capacitor voltage  $v_C$  as a function of time for different capacitances. The electrode gap is 4 mm. From [29].

Some typical spark currents and capacitor voltages as a function of time for different discharge capacitances are shown in Figure 3-10 and Figure 3-11. Because of very small circuit resistance and compact design, the discharge voltage and current show quite “pure” capacitive discharge characteristics, i.e. the spark is scarcely prolonged due to impedance. Discharge times are about 100 ns, which is consistent with measurements of electrostatic current made by Smallwood [32].

In a simple circuit simulation, in which the spark conductivity was assumed proportional to the cumulated spark energy, the measured current and voltage waveforms could be reproduced reasonably well by tuning the proportionality factor between conductivity and spark energy. This factor was found to depend on the breakdown voltage. It was assumed that the discharge could be described by a very simple equivalent discharge circuit shown in Figure 3-12, implicating that the charging resistor carried no current during the duration of the discharge.

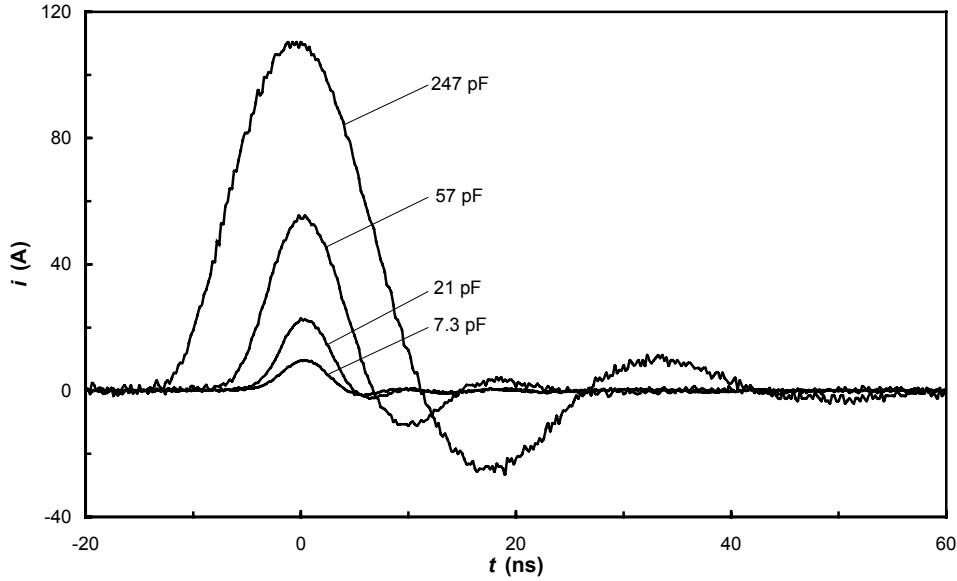

**Figure 3-11.** Balanced current  $i$  as a function of time for different capacitances. The current traces are from the same discharges as the corresponding voltage traces in Figure 3-10. From [29].

The assumption that no current flows through the charging resistor during the duration of discharge is very important for evaluating the integrated spark energy. If the charging resistance is too small, the cumulative energy continues to increase even after the upper time limit of the integral in Equation (3.6). The circuit simulation confirms that the assumption of a “pure” capacitive discharge is reasonably correct.

Using capacitances between a few pF and about 250 pF, spark energies between about 0.03 and 7 mJ could be achieved. The energies also depended on the electrode gap and the according breakdown voltage. The generator thus yields energies down to two orders of magnitude lower than current standard test apparatus for determination of MIE of dust clouds.

The main difference between this circuit and the ones used for spark generation in conventional spark generators is that it is very compact and simple, without e.g. switches that introduce stray capacitance and additional energy. Furthermore, the use of relatively short spark gaps offers the possibility to generate sparks of very low energies. The lowest spark energies generated involved pointed electrodes and a gap of 1-2 mm.

The discharge circuit has some similarities to the circuit presented in paragraph 2, Section 3.1 (Figure 3-2), where a static high-voltage source is

used to charge the capacitor instead of a high-voltage pulse. However, when a pulse is used, the time of spark discharge is much more precisely determined than when the discharge capacitor voltage is slowly raised until breakdown. In addition, the charging resistor value must be several orders of magnitude higher when using static voltage compared to when using a pulse, implying the use of impractically large resistors at low discharge capacitor values.

Further details about the circuit and the spark energy measurement system are given in [29], and details about using the circuit for ignition testing are given in [33].

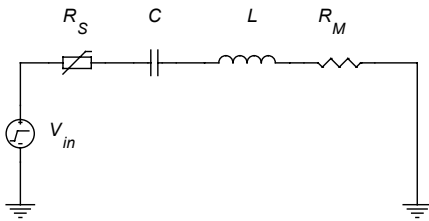

**Figure 3-12.** Equivalent discharge circuit. The spark gap is replaced by a variable spark resistance  $R_S$ .  $C$  is the discharge capacitance,  $L$  the inductance and  $R_M$  the value of the measurement resistors. The input pulse  $V_{in}$  is a step pulse with amplitude corresponding to the breakdown voltage. From [29].

## 4 Considerations on MIE testing

One fundamental question when it comes to the industrial relevance of MIE values for dust clouds obtained in standard tests is whether the laboratory conditions resemble the practical industrial situation. This applies both to the manner in which electric sparks are triggered, and to the electrical characteristics of the sparks. In the present work, both of these aspects have been investigated.

### *4.1 Current standard methods for MIE testing*

Current standard test methods for MIE are based on the generation of a transient dust cloud by an air blast. A spark is then generated at a preset delay time, ensuring optimal conditions (dust concentration and level of turbulence) for ignition at the time of sparkover.

According to current standards [3, 4], the electric spark is to be generated using one of principles 1-5 discussed in Section 3.1. Because of the technical difficulties of generating sparks of very low energies, the lower energy limit of all of these standard methods for generation of sparks is about 1 mJ.

MIE depends strongly on the discharge duration, and a series inductance of about 1 mH should therefore be added when the lowest possible MIE is to be found. However, when the dust's ignition sensitivity to electrostatic discharges is the concern, no series inductance is added.

A major limitation of standard MIE testing is that only limited control of the discharge characteristics is available, even if it is well known that the discharge duration is of major importance for the incendivity of the spark.

### *4.2 Spark duration and incendivity*

The duration of the spark discharge is found to have significant influence on the MIE for both gases and dusts. Considerable work involving composite sparks has been performed on gas ignition of lean mixtures, e.g. [14-16, 21,

34, 35]. It is generally found that for such discharges there exists an optimum discharge duration, illustrated in Figure 4-1.

As discussed by Randeberg and Eckhoff [33], the major scattering of reported MIEs of propane in air can probably be attributed mainly to differences in duration of the sparks used by various investigators. The type of electric circuit involved determines the mode of the discharge, and the energy dissipated in the spark gap during the different phases of the discharge (refer to Section 2.3.4) probably plays an important role.

For dust clouds, the duration of the discharge has a particularly strong influence on the MIE for relatively high energies. Boyle and Llewellyn [36] found that the MIE, calculated as the stored capacitor energy ( $\frac{1}{2}CV^2$ ), decreased when a series resistance of about  $10^4 \Omega$  was introduced in the discharge circuit. Even though a substantial amount of energy was lost in the resistor, the required total capacitor energy for ignition decreased by a factor of about ten for both granular aluminium and magnesium. The values of the series resistance and capacitance that gave the most incendiary sparks were found for discharge durations in the rate 0.1-1.0 ms. Figure 4-2 shows MIE as a function of series resistance.

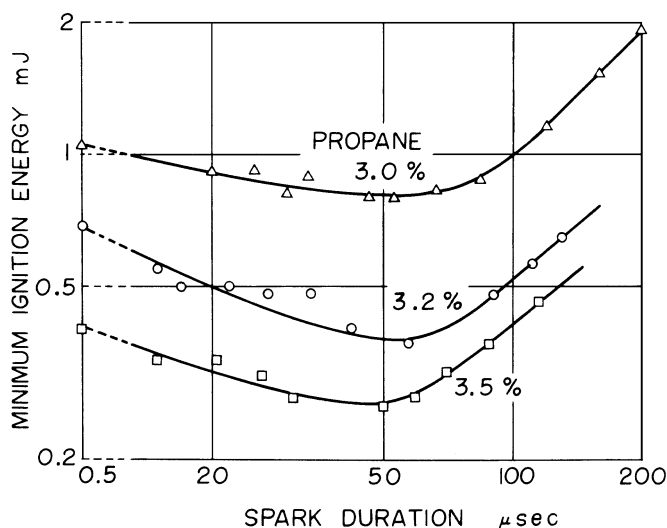

**Figure 4-1.** Effect of spark duration on minimum ignition energy. For gap lengths nearly equal to quenching distance in quiescent propane-air mixtures; tungsten electrodes,  $30^\circ$  half-angle cone, diameter 0.3 mm. From [34].

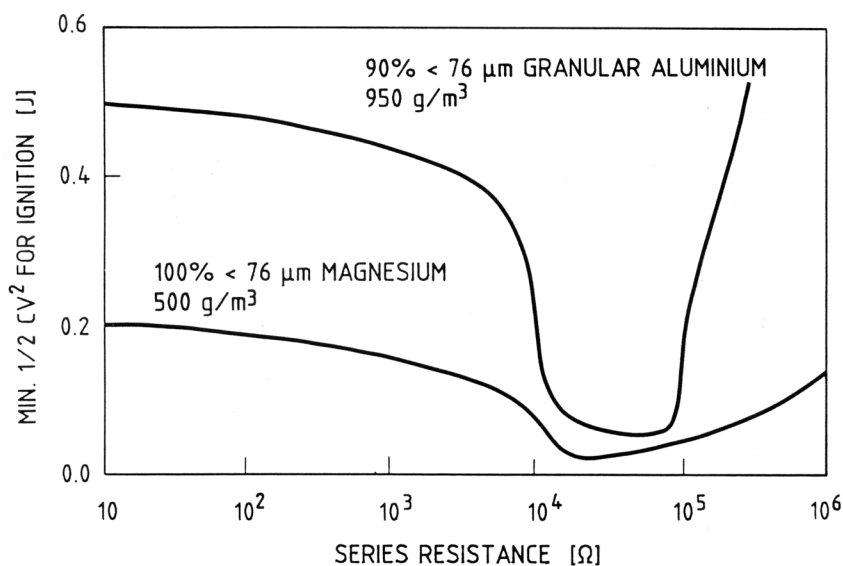
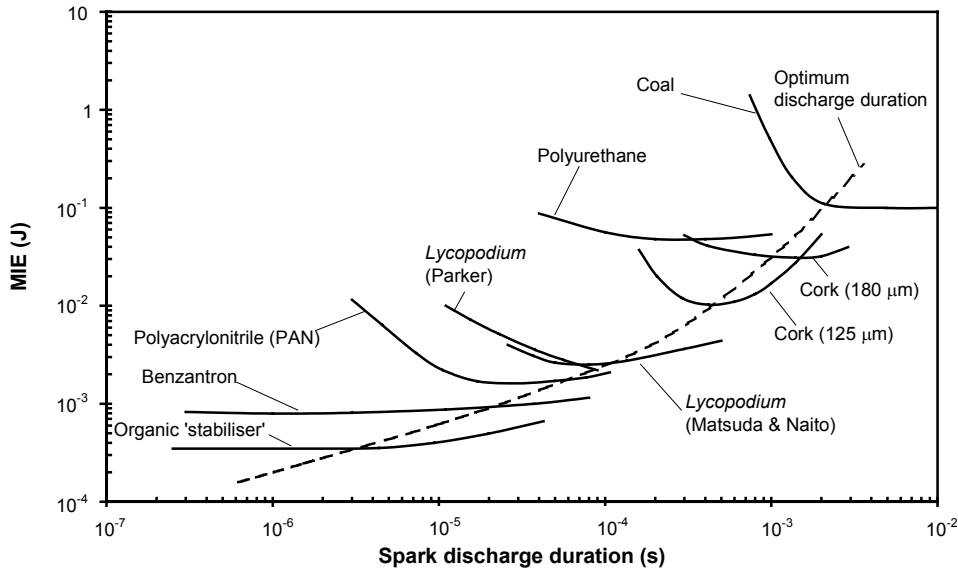

**Figure 4-2.** Results from ignition of dust clouds by capacitive sparks, using an additional series resistance in the discharge circuit. From [36].

Line *et al.* [37] also found a profound reduction in MIE when inserting a series resistor in the discharge circuit, and suggested that the blast wave from short duration capacitive discharges disturb the dust cloud, creating a dust-free zone around the spark. This was believed to prevent the propagation of a flame kernel.

Eckhoff and Enstad [38] found that the pressure wave from spark discharges of short duration ( $\sim 1 \mu\text{s}$ ) could expel particles far beyond the volume in which dust particles are likely to be ignited by the hot spark channel. When the discharge time was increased ( $\sim 1 \text{ms}$ ), the disturbance decreased significantly. Thus, for relatively high spark energies, sparks of longer duration seem to be more incendiary than sparks of shorter duration.

Using composite sparks, Matsuda and Naito [39] found the optimum discharge duration for *Lycopodium* and two fractions of cork dust. The MIE was found to have a minimum at about  $60 \mu\text{s}$  for *Lycopodium*,  $0.4 \text{ms}$  for cork dust of mean particle diameter of  $125 \mu\text{m}$  and  $1.5 \text{ms}$  for  $180 \mu\text{m}$  cork dust.



**Figure 4-3.** MIEs as functions of discharge duration. Data from Parker [25] for organic ‘stabiliser’, benzantron, polyacrylonitrile (PAN) and *Lycopodium* dusts. Data from Matsuda and Naito [39] for *Lycopodium* and cork dust of mean diameter 125 and 180  $\mu\text{m}$ . Data from Nifuku *et al.* [40] for polyurethane and from Nifuku and Katoh [41, 42] for coal dust. Although the ignition criterion (probability of ignition) varies somewhat between the various workers, the data do indicate a systematic increase of the optimum discharge duration with increasing MIE.

For coal dust, the MIE has been found to decrease with increasing discharge duration [42]. The ignition probability has been found to be smaller when the discharge duration time was small, even when the feeding rate of energy was larger. In these experiments, the spark duration could be varied between 0.1 and 9.9 ms, and the lowest MIEs (about 0.1 J), were found for spark durations above 2 ms. Little information about the characteristics of the spark generator is given.

For a more easily ignitable dust (polyurethane with MIE of 11 mJ), the optimum spark duration has been found to be about 0.2 ms [40]. For longer discharge durations, the MIE was roughly constant.

The influence of discharge duration on the MIE was studied systematically by Parker [25], using electric sparks of duration and energies that could – within the physical limits – be varied independently of each other in a controlled manner. Parker investigated four different clouds of dust in air. For two of the dusts, (*Lycopodium* and PAN) there seemed to be a region of optimum discharge durations. For shorter durations, the MIE



increased markedly. For the other two dusts (benzanthron and an organic stabiliser) with lower MIEs, however, this effect was not observed. Hence, it seems that the optimum discharge duration for ignition depends on the ignitability of the dust cloud.

Figure 4-3 summarises the MIEs as a function of discharge duration for the dusts listed above. As indicated, an optimum discharge duration line may be drawn through the results for the dusts. Because the ignition criterion (probability of ignition) varies somewhat between the various reported data, this line should be considered as a rough estimate. However, the optimum discharge duration decreases systematically with decreasing MIE.

In standard test apparatus, a series inductance of about 1 mH is used to prolong the spark when the general MIE is to be found. For dusts with relatively high MIEs without series inductance, one often finds significantly lower MIEs with series inductance. However, for easily ignitable dusts, the effect of the series inductance is less pronounced. This can be explained in terms of an optimum discharge duration, because a series inductance prolongs the spark.

An interesting feature of Figure 4-3 in the context of the present investigation is that MIE does not seem to increase any longer with decreasing discharge time in the MIE range below 1 mJ. It may rather seem as if MIE is independent of or decreases somewhat with the spark discharge time in this energy range.

### ***4.3 MIEs obtained using the dust cloud itself as a spark trigger***

As described in Section 3.3, accidental ignition of dust clouds by electrostatic spark discharges do not involve the kind of “artificial” synchronisation used in laboratory experiments. However, in practical situations the explosive dust cloud itself may play an important role in triggering the spark discharge when the electrodes are pre-charged to a high-voltage somewhat below breakdown. Using a method of triggering the spark by dispersing dust between the electrodes charged at a voltage somewhat

below breakdown, MIEs of maize starch, *Lycopodium* and sulphur dust were determined by Randeberg and Eckhoff [30]. The investigation showed that the MIEs were somewhat higher than when using conventional synchronised sparks, but mostly of the same order. Furthermore, the frequency of ignition was low even at relatively high spark energies. This is ascribed to the great variation in the conditions (level of turbulence and concentration) at the time of spark triggering, because the delay time between dust dispersion and sparkover is beyond control. Hence, the dust concentration and turbulence are not optimised, which must also be the case in industrial accidental ignition.

In another investigation [33], MIE of titanium dust was determined using the same method of spark triggering. This dust could be ignited by sparks of energies below 1 mJ even in this case. The MIE found when using synchronised sparks was even lower, as discussed in Section 4.4.

An illustration of the possibility of optimising and controlling the experimental conditions in order to achieve high ignition probability is shown in Figure 4-4. Here, data from Randeberg and Eckhoff [30], using the transient dust cloud to trigger the spark is compared to the results from experiments with synchronised sparks by Eckhoff [43] and Mathisen [44]. The latter worker optimised the entire procedure, ensuring the best possible conditions for ignition. As the figure shows, the major consequence of this optimisation is that the frequency of ignition increases more rapidly from zero to one, i.e. the region of ignition uncertainty decreases. When using the method of triggering the spark by the dust cloud itself, ignition of *Lycopodium* is not certain even at quite high spark energies.

However, the lowest spark energies yielding ignition is less sensitive to the level of optimisation. Even when using a method where the conditions at the time of sparkover are far from optimal, the lowest spark ignition energies are relatively close to the values obtained through careful optimisation. This indicates that the number of trials, when using the dust cloud to trigger the spark, may be the limiting factor when attempting to find the lowest possible MIE. Hence, it could well be that a high number of repeated tests, say 100, at a spark energy in the range 6-10 mJ would have resulted in an ignition probability  $> 0$  even in this case.

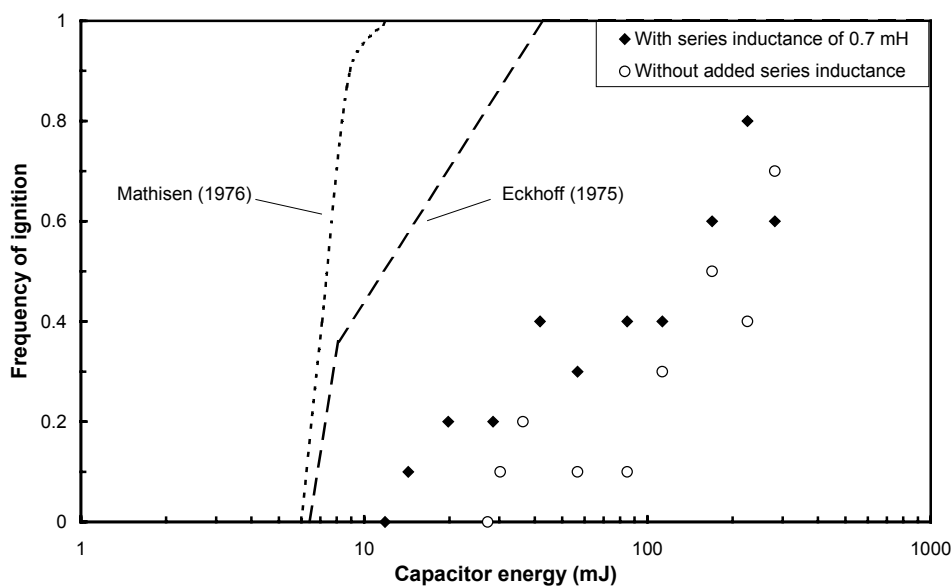

**Figure 4-4.** Frequency of ignition for transient clouds of *Lycopodium* in air as a function of stored capacitor energy for pure capacitive and prolonged sparks (with added series inductance), from [30]. Each data point represents ten ignition trials when using the dust cloud itself to trigger the spark. Data from Eckhoff [43] and Mathisen [44] are added.

The industrial situation may involve a very broad range of conditions with regards to both level of turbulence and concentration of occurring explosive dust clouds. Thus, conservative estimates of MIE should involve a relatively high level of optimisation to ensure optimal (i.e. worst case) conditions for ignition. The number of repeated tests can also be reduced when conditions are optimised. However, an assessment of the probability of ignition in a representative industrial situation may also be of interest, offering an evaluation of cost versus benefit with regards to implementing protective measures.

#### 4.4 MIEs obtained when using the new spark generator

Using the spark generator described in Section 3.4, the MIEs of various concentrations of propane in air and for a number of easily ignitable dusts were determined by Randeberg and Eckhoff [33].

The results for propane in air are shown in Figure 4-5. The estimated MIE curve is significantly below what has been reported by most workers. However, when using discharge circuits where the discharge duration could

be varied [25, 34], MIEs of the same order as with the new spark generator were achieved for similar spark durations. It is believed that the variation in reported MIEs can be ascribed to the characteristics of the electric circuit and the discharge duration. This is discussed in further detail in [33].

Using the new spark generator to investigate the MIEs of easily ignitable dust clouds, very low values were obtained. For some of the dusts, the lowest spark energies that caused ignition were two orders of magnitude lower than the minimum spark energy limit of standard MIE equipment for dusts. However, because of inherent limitations of the spark generator, true MIEs could not be found for three of the dusts (titanium grade E, sulphur and aluminium flakes). The ignition data is summarised in Table 4-1.

If there exists an optimum discharge duration for a given MIE, as indicated by the dotted line in Figure 4-3, it is expected to be very short for the most easily ignitable dust clouds. For dusts with MIE of about 0.1 mJ or less, sparks with discharge durations of about  $10^{-7}$  s, which is the case with the present generator, may be the most incendiary.

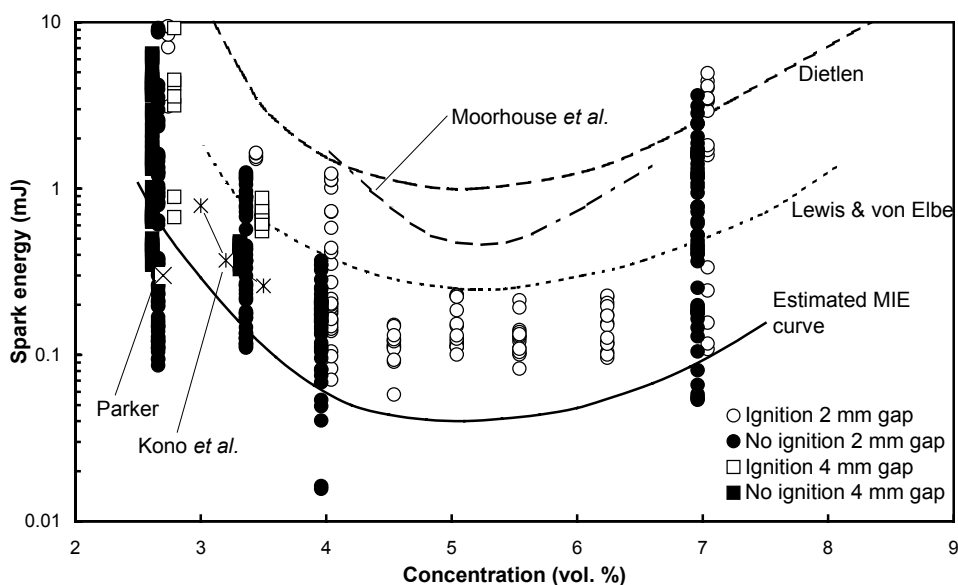

**Figure 4-5.** Minimum ignition energies for propane/air mixtures as a function of propane concentration. The white data points indicate ignition and the black no ignition, with 2 mm electrode gap represented as circles and 4 mm gap as squares. The solid line is an estimated MIE. Main data from [33]. Literature values are added [24, 25, 34, 45, 46].

**Table 4-1.** Summarised MIEs for various dust clouds in air and comparison with previously reported MIE data. Main data from [33].

Dust	MIE in the present tests (mJ)	MIE reported in earlier work (mJ)	MIE for dust layers (mJ)
CaRo 03	0.54	0.6–5.1 [47]	
Titanium grade E	< 0.012	} ~10 [48] < 200 [49]	0.32 [50]
Titanium grade S	0.36		1.0 [50]
Zirconium hydride	0.13		3.2 [50]
Titanium hydride	0.19		5.0 [50]
Sulphur	< 0.043		{ 0.01 [5] 0.3 [43]
Aluminium flakes	< 0.018	{ 0.1 [5] 1 [43]	
SIBS-K32	0.10	< 1 [51]	

Accidental electrostatic sparks in industrial plants should also be expected to be short-duration discharges. The risk of tribo-electric charging of un-earthed metal objects may therefore implicate that even quite small objects (screws, bolts etc.) must be earthed to reduce the risk of ignition of very easily ignitable dust clouds, in accordance with Table 1-2. However, a distinction between the handling of conductive and dielectric dusts should probably be made. Conductive dusts that tend to stick to surfaces may prevent triboelectric charge build-up because a layer of dust may cause sufficient earthing. Hence, the handling of dielectric dusts with very low MIEs may offer the greatest challenge when reducing the risk of accidental electrostatic spark ignition.

#### ***4.5 Implications for the industrial handling of dusts with very low MIEs***

As current standard tests for MIE do not offer the ability to quantify MIEs in the sub 1 mJ range, the results from the present investigations may implicate a new perspective on industrial dust explosion hazards. If the dust of concern has MIE considerably lower than 1 mJ even minor unearthed

plant items of very low capacitances of the order of 1 pF may be hazardous under certain circumstances.

Mechanisms of charging and discharging such unearthed items were discussed by Eckhoff and Randeberg [52]. A key question is how electrostatic charging of unearthed metal objects may take place in practice when producing and handling powders. In addition, the consequences of very low MIEs for the selection of practical safety measures for preventing accidental electrostatic spark ignition were discussed. For example, spark discharges may result if a tramp metal object enters an earthed metal silo accidentally.

It would seem, therefore, that being able to quantify MIEs in the sub 1 mJ range may sometimes be a relevant safety concern.

## ***4.6 Suggestions for further work***

### ***4.6.1 The mechanisms involved when dust particles trigger breakdown***

Randeberg and Eckhoff [30] considered the mechanisms involved when a dust cloud causes electrical breakdown between electrodes preset at a voltage somewhat between breakdown in pure air. The following effects were considered relevant in breakdown of the spark gap:

1. The electric field is intensified due to the presence of the particles, potentially causing the dielectric media between the electrodes to break down.
2. Charged particles – caused by e.g. triboelectric effects – contribute even more to the field intensification. They can also act as charge carriers, initiating the breakdown.
3. Conductive particles may act as protrusions at the electrodes, shortening the gap and intensifying the electric field to breakdown.

A brief investigation of different dust's ability to trigger breakdown was performed by determining the voltage at which breakdown was triggered three times successively. The circuit used is shown in Figure 3-7, and the method involved dispersing the dust between the electrodes inside the

explosion chamber and monitoring whether a spark was triggered. The results from this investigation are shown in Table 4-2.

No thorough explanation of the dusts' different ability to trigger breakdown, measured in this way, has been offered. However, coarse particles seem to trigger the breakdown at lower voltages than finer ones, in agreement with what is reported by others [53]. On the other hand, the data shows no pronounced difference between conductive and dielectric dusts in their ability to initiate breakdown. Such a difference would be expected from e.g. [54].

**Table 4-2.** Spark triggering voltages. Summary of the voltages (in steps of 0.5 kV) at which the same nominal concentration of different dusts gives three consecutive triggerings of the spark. From [30].

Dust type	Stable triggering voltage (kV)
Pure air (no dust)	13.0
Lycopodium clavatum	7.5
Magnesium, very coarse	7.5
PMMA, coarse fraction	8.0
Maize starch	8.5
PMMA, fine fraction	8.5
Niacinamide	8.5
Aluminium	9.0
Bronze	9.0
Niacin	9.5
Coal (Indonesian)	10.0
Rice flour	10.0
Rape flour	10.0
Silicon, coarse fraction	10.0
Sulphur	10.0
Silicon, fine fraction	11.0

In general, it is difficult to identify the properties that can account for the different behaviour of the dusts. The influence of the degree of dust dispersion is also unknown. Further investigations should therefore be carried out to examine which particle properties influence the mechanisms of breakdown. The following properties could be of importance:

- The permittivity of dielectric particles
- Particle shape
- Particle size distribution
- Dispersibility of the powder/dust

#### *4.6.2 Development of a new low-energy standard test apparatus*

Based on the spark generator described in [29] and employed in [33], a new standard test apparatus for the energy region below 1 mJ could be developed. Further development of the spark generator could possibly offer even lower spark energies.

A system for optimal selection of the charging resistance according to the discharge capacitance should be made (see Section 3.4). In this way, the influence of additional charging of the discharge capacitor during discharge can be effectively eliminated through calibration.

A more compact design can reduce the stray capacitance somewhat compared with that of the apparatus used in the present investigation, and thus reduce the total discharge capacitance. This can possibly lower the spark energy by a factor of 2-3 for a given electrode configuration. However, the changes in the discharge circuit's stray inductance resulting from the design changes should also be taken into account, as this may influence the discharge duration.

Further insight gained from simulation of the discharge may offer the opportunity to make the voltage measurements superfluous. In that case, the spark energy can be calculated by estimating the voltage from the measured spark current. Because the voltage probe adds 3.0 pF to the discharge capacitance, the lower spark energy limit of the circuit may therefore be reduced further.



## 5 Conclusions

1. During the last 30 years the assumed lower limit of MIEs of dust clouds has dropped by several orders of magnitude, from the order of 10 mJ suggested by US Bureau of Mines in the 1960s, via the order of 1 mJ indicated by Eckhoff (1975) to the order of 0.01 mJ indicated by Bartknecht (1993) and demonstrated by the present work.
2. In the present work, a new method of generating electric sparks of very low energies and very short duration has been developed, and MIEs of a number of easily ignitable dust clouds have been determined. The MIEs were related to the previously reported optimum discharge duration for ignition of dust clouds, in agreement with the observation of decreasing optimum discharge duration for ignition with decreasing MIE.
3. The new spark generator may be used as a basis for developing a standard test apparatus for determination of MIE of dust clouds in the very low-energy region between 0.01 and 1 mJ. It is believed that even lower spark energies can be attained if the spark generator is developed further.
4. Experiments where the electric spark was triggered by the explosive dust cloud itself were also conducted. This offers an alternative method of determining the MIE of dust clouds. This method of spark triggering is believed to be closer to the mechanism of accidental electrostatic spark initiation in an industrial plant, where optimal independent dust dispersion and spark triggering is not a realistic scenario.
5. The MIEs found when using the dust cloud itself to trigger the electric spark were generally of the same order, although somewhat higher, than those obtained using electronic synchronisation between dust dispersion and sparkover. This can most likely be ascribed to the non-optimal conditions for ignition at the time of sparkover in case of dust cloud

triggering. However, even when using the method of triggering the spark by the dust cloud itself, MIEs below 1 mJ could be found.

# References

1. Eckhoff, R.K. (2003) *Dust explosions in the process industries*. 3rd ed, Boston: Gulf Professional Publishing/Elsevier.
2. Lüttgens, G. and M. Glor (1989) *Understanding and controlling static electricity*, Leverkusen: Expert Verlag.
3. CEN (2002) *Determination of minimum ignition energy of dust/air mixtures*, European Standard EN 13821, European Committee for Standardization, Brussels
4. IEC (1994) *Method for determining minimum ignition energies of dust/air mixtures*, IEC International Standard 1241-2-3, International Electrotechnical Commission, Geneva
5. Bartknecht, W. (1993) *Explosionsschutz*, Berlin: Springer-Verlag.
6. Babrauskas, V. (2003) *Ignition Handbook*, Issaquah, Washington: Fire Science Publishers.
7. Lüttgens, G. and N. Wilson (1997) *Electrostatic hazards*, Oxford: Butterworth-Heinemann.
8. Howatson, A.M. (1976) *An introduction to gas discharges*. 2nd ed, Oxford: Pergamon Press Ltd.
9. Meek, J.M. and J.D. Craggs (1953) *Electrical breakdown of gases*, Oxford: Clarendon Press.
10. Meek, J.M. and J.D. Craggs (1978) *Electrical breakdown of gases*, Chichester: John Wiley & Sons.
11. Kuffel, E., W.S. Zaengel, and J. Kuffel (2000) *High voltage engineering: Fundamentals*. 2nd ed, Oxford: Newnes.
12. Cross, J. (1987) *Electrostatics: Principles, problems and applications*, Bristol: Adam Hilger.
13. Ziegler, G.F.W., E.P. Wagner, and R.R. Maly (1984) Ignition of lean methane-air mixtures by high pressure glow and arc discharges, in *Proc. of 20th Symp. (Internat.) on Combustion*: The Combustion Institute. 1817-1824
14. Maly, R. and M. Vogel (1978) Initiation and propagation of flame fronts in lean CH<sub>4</sub>-air mixtures by the three modes of the ignition spark, in *Proc. of 17th Symp. (Internat.) on Combustion*: The Combustion Institute. 821-831
15. Maly, R. (1981) Ignition model for spark discharges and the early phase of flame front growth, in *Proc. of 18th Symp. (Internat.) on Combustion*: The Combustion Institute. 1747-1754

- 
16. Maly, R. (1984) *Spark ignition: Its physics and effect on the internal combustion engine*, in *Fuel economy in road vehicles powered by spark ignition engines*, J.C. Hilliard and G.S. Springer, Editors, Plenum Press: New York. p. 91-148.
  17. Franke, A. (2000) *Diagnostics of electrical phenomena in gases for the monitoring of spark-ignited combustion. Licentiate Thesis LRCP-57*, Lund University: Lund Institute of Technology.
  18. Warnatz, J., U. Maas, and R.W. Dibble (2001) *Combustion. Physical and chemical fundamentals, modeling and simulation, experiments, pollutant formation*. 3rd ed, Berlin Heidelberg New York: Springer-Verlag.
  19. Lim, M.T., R.W. Anderson, and V.S. Arpaci (1987) Prediction of spark kernel development in constant volume combustion, *Combust. Flame*, **69**, p. 303-316
  20. Ko, Y., R.W. Anderson, and V.S. Arpaci (1991) Spark ignition of propane-air mixtures near the minimum ignition energy: Part I. An experimental study, *Combust. Flame*, **83**, p. 75-87
  21. Ishii, K., *et al.* (1992) Investigation of ignition by composite sparks under high turbulence intensity conditions, in *Proc. of 24th Symp. (Internat.) on Combustion*: The Combustion Institute. 1793-1798
  22. Strid, K.-G. (1973) Experimental techniques for the determination of ignition energy, *Oxid. Combust. Rev*, **6**, p. 1-46
  23. Cheng, D.Y. (1967) Minimum ignition energy determination by switchless spark discharge scheme, *Combust. Flame*, **11**, p. 517-518
  24. Moorhouse, J., A. Williams, and T.E. Maddison (1974) An investigation of the minimum ignition energies of some C<sub>1</sub> to C<sub>7</sub> hydrocarbons, *Combust. Flame*, **23**, p. 203-213
  25. Parker, S.J. (1985) *Electric spark ignition of gases and dusts*, Ph.D. Thesis, The City University, London
  26. Ballal, D.R. and A.H. Lefebvre (1975) The influence of spark discharge characteristics on minimum ignition energy in flowing gases, *Combust. Flame*, **24**, p. 99-108
  27. Ballal, D.R. and A.H. Lefebvre (1977) Ignition and flame quenching in flowing gaseous mixtures, *Proc. R. Soc. Lond. A*, **357**, p. 163-181
  28. Riddlestone, H.G. (1951) *The effect of series resistance on the energy dissipated in capacitive spark discharges across small gaps*, ERA report G/T253, The British Electrical and Allied Industries Research Association,

- 
29. Randeberg, E., W. Olsen, and R.K. Eckhoff (2006) A new method for generation of synchronised capacitive sparks of low energy, *J. Electrostat.*, **64**, p. 263-272
  30. Randeberg, E. and R.K. Eckhoff (2006) Initiation of dust explosions by electric spark discharges triggered by the explosive dust cloud itself, *J. Loss Prevent. Proc.*, **19**, p. 154-160
  31. Eckhoff, R.K. and E. Randeberg (2005) A plausible mechanism of initiation of dust explosions by electrostatic spark discharges in industrial practice, *VDI Berichte*, **1873**, p. 185-197
  32. Smallwood, J.M. (1999) Simple passive transmission line probes for electrostatic discharge measurements, *Inst. Phys. Conf. Ser.*, **No. 163**, p. 363-366
  33. Randeberg, E. and R.K. Eckhoff (2006) Measurement of minimum ignition energies of dust clouds in the < 1 mJ region, *Paper submitted for publication in Journal of Hazardous Materials*
  34. Kono, M., S. Kumagai, and T. Sakai (1976) The optimum condition for ignition of gases by composite sparks, in *Proc. of 16th Symp. (Internat.) on Combustion*: The Combustion Institute. p. 757-766
  35. Ujiie, Y. (1994) Spark ignition properties of combustible mixtures under high-turbulence-intensity conditions, *JSME Int. J. B - Fluid. T.*, **37**, p. 611-617
  36. Boyle, A.R. and F.J. Llewellyn (1950) The electrostatic ignitibility of dust clouds and powders, *J. Soc. Chem. Ind. Trans.*, **69**, p. 173-181
  37. Line, L.E., H.A. Rhodes, and T.E. Gilmer (1959) The spark ignition of dust clouds, *J. Phys. Chem.*, **63**, p. 290-294
  38. Eckhoff, R.K. and G. Enstad (1976) Why are "long" electric sparks more effective dust explosion initiators than "short" ones?, *Combust. Flame*, **27**, p. 139-131
  39. Matsuda, T. and M. Naito (1983) *Effects of a spark discharge duration on ignition energy for dust-air suspension*, in *Particulate Systems. Technology and Fundamentals*, J.K. Beddow, Editor, McGraw-Hill international book company. p. 189-198.
  40. Nifuku, M., *et al.* (2005) A study on the ignition characteristics for dust explosion of industrial wastes, *Journal of Electrostatics*, **63**, p. 455-462
  41. Nifuku, M. and H. Katoh (2001) Incendiary characteristics of electrostatic discharge for dust and gas explosion, *J. Loss Prevent. Proc.*, **14**, p. 547-551

- 
42. Nifuku, M. and H. Katoh (2003) A study on the static electrification of powders during pneumatic transportation and the ignition of dust cloud, *Powder Technology*, **135-136**, p. 234-242
  43. Eckhoff, R.K. (1975) Towards absolute minimum ignition energies for dust clouds?, *Combust. Flame*, **24**, p. 53-64
  44. Mathisen, K.P. (1976) *Minimum ignition energy for lycopodium dust clouds determined in the Hartmann apparatus*, CMI Report 76089-2, CMI, Bergen, Norway
  45. Dietlen, S. (1976) *Ermittlung der Mindestzündenergie brennbarer Gase in Mischung mit Luft*, BAM-Bericht Nr. 42, Der Bundestanstalt für Materialprüfung, Berlin
  46. Lewis, B. and G. von Elbe (1987) *Combustion, flames and explosions of gases*. 3rd ed, ed. B. Lewis and G. von Elbe, London: Academic Press.
  47. Cesana, C. (2004) *Final Report. Calibration-Round-Robin CaRo 03*, B052\_185, Adolf Kühner AG, Birsfelden, Switzerland
  48. Jacobson, M., A.R. Cooper, and J. Nagy (1964) *Explosibility of metal powders*, Report 6516, US Bureau of Mines, Washington
  49. Hartmann, I., J. Nagy, and H.R. Brown (1943) *Inflammability and explosibility of metal powders*, Report 3722, US Bureau of Mines, Washington
  50. Wilfing, G. (2004) *Personal communication. Ignition energies of bulk powders*: Chemetall GmbH, Langelsheim, Germany.
  51. Glor, M. (2005) *Personal communication. Information on MIE of the dust SIBS-K32*: The Swiss Institute of Safety & Security, Basel, Switzerland.
  52. Eckhoff, R.K. and E. Randeberg (2006) Electrostatic spark ignition of sensitive dust clouds of MIE < 1 mJ, *Symposium paper submitted for The Sixth International Symposium on Hazards, Prevention, and Mitigation of Industrial Explosions August 27 - September 1, 2006*
  53. Dascalescu, L., A. Samuila, and R. Tobazéon (1997) Size of solid contaminants and formation of particle chains: two factors affecting the dielectric strength of insulating gases, *J. Electrostat.*, **40-41**, p. 419-424
  54. Dascalescu, L., A. Samuila, and R. Tobazéon (1996) Cylindrical conductive particles in the proximity of an electrode affected by a high-intensity electric field, *J. Electrostat.*, **37**, p. 173-196
  55. Cesana, C. and R. Siwek (2001) *MIKE 3. Minimum Ignition Energy*, Adolf Kühner AG, Birsfelden, Switzerland