

Strained Fraternity



IDENTITY FORMATIONS, MIGRATION AND SOCIAL TRANSFORMATION
AMONG SRI LANKAN TAMILS IN TAMIL NADU, INDIA

NICOLAY PAUS

THESIS SUBMITTED IN PARTIAL
FULFILMENT OF THE CAND.POLIT DEGREE
DEPT. OF SOCIAL ANTHROPOLOGY
UNIVERSITY OF BERGEN
APRIL 2005

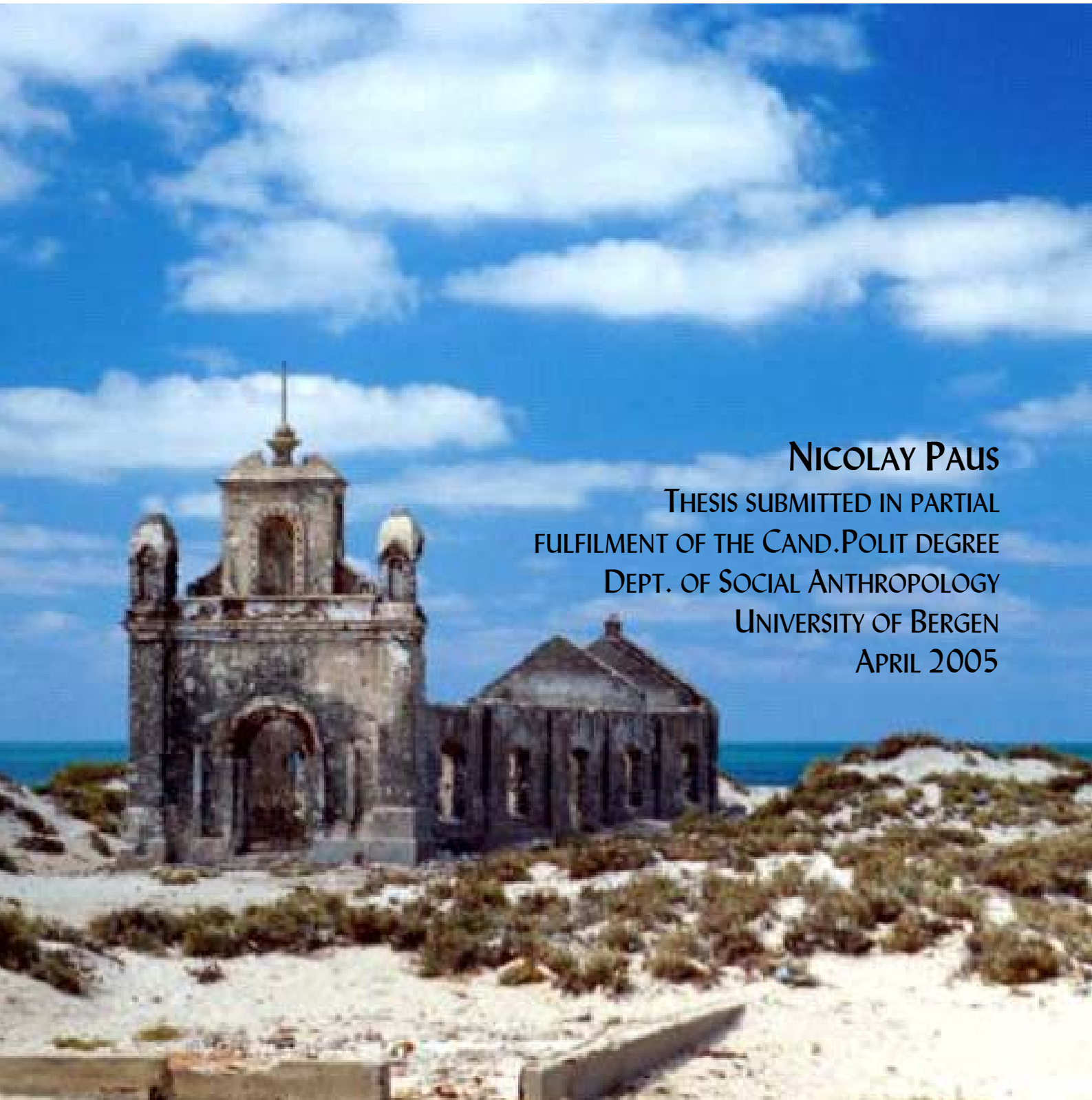

ACKNOWLEDGEMENTS

This research could not have been conducted without the assistance and help of several people. I am primarily indebted to my dear friends in India and Sri Lanka who, in spite of their sense of insecurity, warmly received me and accepted me as a part of their lives. I also wish to thank Fr. Elias and other people from the Jesuit community in Tamil Nadu, Agnes Fernando, as well as the people at OfERR for helping me in the initial difficult stages of my fieldwork. Their help were of immense importance for me, and my research would have been much more difficult to carry out were it not for their assistance. Discussions with Manuelpillai Sooaipillai and Joseph Soosai were also helpful while preparing my journey to India.

I also wish to stress my sincere gratitude to my supervisors during these years, Professor Leif Manger and Professor Bruce Kapferer. Their knowledge, feedbacks and advises have been highly appreciated. Furthermore, I wish to thank the Chr. Michelsen Institute where I have been affiliated as a student since February 2003. The academic environment and discussions with people at the institute has been very aspiring and helpful for my work.

I am indebted to Marianne Longum Gauperaa for her great support before, during and after my fieldwork. Her own experiences and backing was of great help. Moreover, I wish to stress my sincere thankfulness to Bård Kårtveit, Bjørn Enge Bertelsen, Ragnhild Berg, Hege Toje and Tone Sissener for their constructive and helpful comments and feedbacks even when they were loaded with their own work. Also, thanks to Hege Myrlund Larsen for motivating and inspiring discussions on Sri Lanka. Many ideas were conceived during these conversations. Finally, a great thanks to my fellow students at the University of Bergen, Trine Syverinsen, Hanna Ihlebæk, Hanna Skartveit, Olav Aanestad, Siv Elin Ånestad, Bernhard Benum, Helene Corneliussen, Marthe Eikum Tang and others who have contributed to make my time as a student so enjoyable. Conclusively, I wish to thank Lise og Arnfinn Hejes fond for vital economic support.

Contents

Contents	v
ABBREVIATIONS	ix
MEASUREMENTS AND EXCHANGE RATES	ix
CENTRAL POLITICAL PERSONALITIES IN THE TEXT	x
GLOSSARY	xi
Chapter 1 – Introduction.....	1
THE FIELD OF RESEARCH	4
OUTLINE OF CHAPTERS	5
CENTRAL THEORETICAL APPROACHES	9
CLARIFICATIONS OF NAMES AND CONCEPTS	17
Chapter 2 – History and nationalism as premises for contemporary adaptation.....	19
INTRODUCTION	19
THE BRITISH RAJ AND THE ‘REINVENTION’ OF CEYLONESE SOCIETY	20
THE EMERGENCE OF NATIONALISM IN SRI LANKA	22
NEGOTIATING EMERGING NATIONALIST MYTHOLOGIES	23
POLITICISING LEGENDS AND THE PAST IN A NATIONALIST PROJECT	24
QUESTIONING LEGENDS AND THE PAST IN NATIONALIST DISCOURSES	25
1948: INDEPENDENCE PREVAILS	27
INDEPENDENCE AND THE DISFRANCHISEMENT OF THE UPCOUNTRY TAMILS	27
THE LANGUAGE ISSUE AND ‘SINHALA ONLY’	28
WIDENING THE GAP	29
TAMIL MILITANCY.....	30
JULY 1983	31
THIMPU	31
THE IPKF AND THE INDO-SRI LANKAN ACCORD	32
EELAM WARS AND PEACE PROCESSES	33
TAMIL NATIONALISM AND ‘DRAVIDIANISM’ IN TAMIL NADU	35
‘PERIYAR’ AND THE NON-BRAHMIN MOVEMENT	36
DMK AND THE RISE OF DRAVIDIAN PARTY POLITICS IN TAMIL NADU	37
NATIONAL INDIAN POLICY TOWARDS THE SRI LANKAN ISSUE	38
1971, RAW AND INDIA’S ARMING OF THE SRI LANKAN MILITANTS	38
DRAVIDIANISM AND SRI LANKAN TAMIL NATIONALISM, PRE-1980	39
1983 – THE SRI LANKAN REFUGEES AND CHANGING LOCAL TAMIL POLITICS	40
DETERIORATING RELATIONS	41
FINAL REMARK	42
Chapter 3 – Sri Lankans in India in local contexts	45
INTRODUCTION	45
THE TRANSITION.....	45
INDIAN REFUGEE POLICY AND THE REFUGEES IN INDIA	48
CAMP REFUGEES	50
OFERR	50
ECONOMIC AND SOCIAL SITUATION.....	51
FREEDOM OF MOVEMENT, WORK AND EDUCATION	53
CAMP LODGING	54
MILITANTS IN SPECIAL CAMPS	54
SRI LANKANS OUTSIDE CAMPS.....	55
OFFICIAL STATUS OF THE SRI LANKANS.....	56

RAJA NAGAR AND ITS SURROUNDINGS	56
THE LOCATION	56
CASTE AND GEOGRAPHICAL ORIGIN	58
THE WIDER LOCALITY – EXTENDED SETTLEMENT PATTERNS	59
SOCIAL LIFE AND INTERACTION	60
Chapter 4 – Reflections on fieldwork challenges	63
INTRODUCTION	63
FEAR AND SENSITIVITY	65
TRUST AND POWER AS METHODOLOGICAL FACTORS	65
SENSITIVITY AND THE COLLECTION OF DATA	66
INSECURITY AND SELF-PRESENTATION	67
FIELDWORK AND LOCALITY	68
CONDUCTING FIELDWORK	70
LONG-LASTING FIELDWORK	70
ACCESS TO INFORMATION	71
METHODOLOGICAL CHALLENGES: NEUTRALITY, LANGUAGE AND GENDER	71
NEUTRALITY	72
LANGUAGE AND “GATEKEEPERS”	72
“THE MYSTICAL STRANGER”	74
WOMEN AND GENDER ISSUES	75
ANONYMITY.....	77
Chapter 5 – Identity and local life.....	79
INTRODUCTION	79
SOCIAL LIFE AND IDENTITIES IN RAJA NAGAR.....	80
THE NEGOTIATION OF IDENTITIES	81
THE LIFE-WORLD	83
CATEGORISATIONS, NEGOTIATIONS AND MANAGING IDENTITIES	85
NATIONALITY AND ETHNIC STEREOTYPES.....	86
SRI LANKAN PERCEPTIONS ON INDIANS	87
INDIAN PERCEPTIONS ON SRI LANKANS	88
CULTURAL DIVERSITY AND EMBODIED KNOWLEDGE	90
INTERNAL CATEGORISATION AND VARIATION AMONG SRI LANKANS	92
COLOMBO TAMILS, UPCOUNTRY TAMILS AND JAFFNA TAMILS.....	92
CASTE AS DIFFERENTIATOR	99
FLUCTUATING IDENTITIES AND COPING STRATEGIES	103
BLURRED IDENTITIES.....	103
ANONYMITY AND THE DISGUISED IDENTITIES	106
THE ‘SRI LANKAN REFUGEE’ IDENTITY	107
LOCAL DYNAMICS AND EXPERIENCES	111
CORRUPTION, MEDIA AND ENCOUNTERS WITH THE STATE	112
LOCAL EXPERIENCES AND CONCEPTIONS OF PRIMORDIALITY	114
SRI LANKANS’ EXPERIENCES	114
INDIANS’ EXPERIENCES	117
GENDER, CORPORAL SYMBOLISM AND DRESSING	118
SUMMARISING IDENTITY NEGOTIATIONS IN RAJA NAGAR	121
Chapter 6 – Trans-national bonds and remittances.....	125
INTRODUCTION	125
DIASPORA AND MIGRATION.....	125
THE SRI LANKAN DIASPORA	126
SRI LANKAN MIGRATION	126
DIASPORIC DOMAINS	129
DIASPORA.....	130
MIGRATION AND MIGRATION THEORIES	134

MOVEMENT AND SETTLEMENT	137
SETTLEMENT PATTERNS, ORIGIN AND SOCIAL DIVISION IN INDIA.....	137
INCENTIVES AND MOTIVATIONS FOR MIGRATION	139
TRANS-NATIONAL BONDS AND LOCAL FORMATIONS	140
DISPERSAL AND TRANS-NATIONALITY	141
ECONOMY, MOMENT OF MIGRATION AND TRANS-NATIONAL BONDS	144
INCOME GROUPS AND MODES OF WEALTH ACQUISITION	147
REMITTANCES AND LOCAL IMPLICATIONS IN RAJA NAGAR.....	151
SPENDING AND INVESTMENTS	151
LOCAL ECONOMIES AND INTERRELATED DOMAINS	153
REMITTANCES AND LOCAL SENTIMENTS.....	154
WEALTH, JEALOUSY AND THE EVIL EYE	155
INFLUENCE AND CONCEPTIONS FROM ABROAD	156
‘WESTERNISATION’ AND RESPECTABILITY	157
IMAGINING THE WEST.....	159
ENDING REMARK	160
Chapter 7 – “A passage from India”	163
INTRODUCTION	163
REPRESENTATIONS OF THE WEST	164
CROSS-NATIONAL MARRIAGES	165
ASPIRATIONS FOR THE ‘WEST’ AND EXPLOITATION OF SRI LANKAN WOMEN IN INDIA ...	165
ORGANISING A MARRIAGE	166
FINDING A SPOUSE.....	168
DOWRY	170
THE MARRIAGE AND FEAR OF LEAVING.....	171
ORGANISING THE JOURNEY ABROAD	172
JUSTIFYING MIGRATION	174
CROSSING BORDERS - ILLANGO’S JOURNEY	176
CONCLUDING REMARK.....	184
Chapter 8 – The ghost of Rajiv Gandhi: The assassination and the transformation of the Sri Lankans in an Indian social order	187
INTRODUCTION	188
POLITICAL CONSEQUENCES: STATE OPPRESSION AND SURVEILLANCE	189
SURVEILLANCE, FEAR AND CORRUPTION	190
SURVEILLANCE	191
CORRUPTION	192
THE SPECIAL CAMPS.....	193
EXTORTION AND CORRUPTION	194
THE SRI LANKAN MILITANTS AND THE Q-BRANCH	197
SIGNS OF MISTRUST AND ERASING HISTORICITY: FEAR, THE BODY AND PLACE OF ORIGIN	198
SIGNS OF MISTRUST.....	200
ERASING HISTORICITY	201
FEAR AND BEHAVIOUR	202
TRANSFORMATION OF THE SRI LANKANS	203
THE TRANSFORMATIVE DIMENSIONS OF THE ASSASSINATION.....	204
LIMINALITY AND THE TRANSFORMATION OF THE SRI LANKANS	206
THE ASSASSINATION AS A LOCALITY PRODUCING EVENT.....	206
RETRIBUTION OF AND ‘LEVELLING OUT’ THE ASSASSINATION	207
THE NEW STATUS OF THE SRI LANKANS.....	208
DISCOURSE AND TRANSFORMATIVE REPRESENTATIONS.....	209
INDIAN NATIONAL DISCOURSE	210
INDIA AND THE LTTE: CONTINUITIES AND BREAKS	212
POWER AT PLAY	213

EXECUTION OF INSTITUTIONALISED POWER	214
INDIAN TAMIL DISCURSIVE FORMATIONS	216
POST-RAJIV GANDHI TAMIL DISCOURSE	218
THE CHANGING OPINION OF THE LOCAL INDIAN POPULATION	220
INDIAN TAMIL POLITICS ON THE SRI LANKAN ISSUE	221
THE SRI LANKAN TAMIL POSITION	223
SRI LANKAN INTERPRETATION OF THE ASSASSINATION	224
PRE-ASSASSINATION	225
THE ASSASSINATION	225
LOCAL APPROACHES ON THE ASSASSINATION	227
EPITOMISING THE POST-RAJIV GANDHI SITUATION	231
Appendices	237
APPENDIX 1: MAP OF TAMIL NADU	237
APPENDIX 2: MAP OF SRI LANKA	238
APPENDIX 3: LIST OF INFORMANTS	239
APPENDIX 4: SONALI'S FAMILY	240
APPENDIX 5: SETTLEMENT PATTERNS IN SONALI'S FAMILY	241
APPENDIX 6: JEYADHANI'S FAMILY	242
APPENDIX 7: RAJKUMAR'S FAMILY	243
Bibliography	245

ABBREVIATIONS

AIADMK	-	<i>All-India Anna Dravidar Munnetra Kazhagam</i> (Anna's all Indian Dravidian Progressive Federation)
BJP	-	<i>Bharatiya Janata Party</i> (Indian People's Party)
Congress (I)	-	Indian National Congress
CWC	-	Ceylon Workers Congress
DK	-	<i>Dravida Kazhagam</i> (Dravidian Federation)
DMK	-	<i>Dravidar Munnetra Kazhagam</i> (Dravidian Progressive Federation)
EPRLF	-	Eelam People's Revolutionary Liberation Front
EROS	-	Eelam Revolutionary Organisation of Students
FP	-	Federal Party (<i>Ilankai Thamil Arasu Kadchi</i>) ⁱ
FRO	-	Foreigners' Registration Office
ICRC	-	International Committee of the Red Cross
IDP	-	Internally Displaced Person
IPKF	-	Indian Peace Keeping Forces
JVP	-	<i>Janatha Vimukthi Perumana</i> (National Liberation Front)
LTTE	-	Liberation Tigers of Tamil Eelam
MDMK	-	<i>Marumalarchi Dravidar Munnetra Kazhagam</i> (Revitalised/"re-blossoming" Dravidian Progressive Federation)
NDA	-	National Democratic Alliance
NGO	-	Non-Governmental Organisation
OfERR	-	Organisation for Eelam Refugee Rehabilitation
PA	-	People's Alliance
PLOT/PLOTE	-	People's Liberation Organisation of Tamil Eelam
PMK	-	<i>Pattali Makkal Kadchi</i> (Toiling People Party)
PTA	-	Prevention of Terrorism Act
RAW	-	Research & Analysis Wing
SAHRDC	-	South Asian Human Rights Documentation Centre
SLA	-	Sri Lankan Army
SLFP	-	Sri Lanka Freedom Party
TELO	-	Tamil Eelam Liberation Organisation
TESO	-	Tamil Nadu Tamil Eelam Supporters Organisation
TULF	-	Tamil United Liberation Front
UNHCR	-	United Nations High Commissariat for Refugees
UNP	-	United National Party

MEASUREMENTS AND EXCHANGE RATES

INR	-	Indian Rupee (45 INR = 1 USD per 2001)
LKR	-	Sri Lankan Rupee (90 LKR = 1 USD per 2001)
USD	-	U.S. Dollar
1 Crore	-	10,000,000 (1,00,00,000)
1 Lakh	-	100,000 (1,00,000)

ⁱ The direct translation of '*Ilankai Thamil Arasu Kadchi*' is 'the party for a Ceylon Tamil government'. The official English name is however: 'The federal Freedom party of the Tamil-speaking Peoples'.

CENTRAL POLITICAL PERSONALITIES IN THE TEXT

Annadurai, C.N. (1909-69):	Indian Tamil politician, actor and play-writer. Founder of DMK in 1949. Chief Minister in Tamil Nadu: 1967-69.
Bandaranaike, Sirimavo (1916-2000):	Wife of the assassinated Prime Minister S.W.R.D. Bandaranaike, and Prime Minister of Sri Lanka representing SLFP: 1960-65, 1970-77, 1994-2000.
Chelvanayagam, S.J.V. (1898-1977):	Sri Lankan Tamil politician and lawyer, and one of the founding fathers of the FP. The most prominent Tamil politician in the period: 1958-77.
Gandhi, Indira (1917-84):	Former Indian Prime Minister (1966-77, 1980-84) for Congress (I), daughter of India's first Prime Minister Jawaharlal Nehru. Assassinated by her Sikh bodyguards.
Gandhi, Rajiv (1944-91):	Former Indian Prime Minister (1984-89) for Congress (I), son of Indira. Assassinated by the LTTE.
Jayalalitha, J. (1948-):	Former Indian Tamil actress, now politician representing AIADMK. Chief Minister in Tamil Nadu: 1991-96, May-Sept. 2001, 2002- .
Jayawardene, Junius Richard (1906-96):	Former Sri Lankan Prime Minister (1977-78) and President (1978-90) representing the UNP.
Karunanidhi, M. (1923-):	Indian Tamil politician, poet and scriptwriter. One of the founders of DMK in 1949. Chief Minister in Tamil Nadu: 1969-76, 1989-91, 1996-2001.
Kumaratunga, Chandrika (1945-):	Daughter of S.W.R.D. and Sirimavo Bandaranaike. Sri Lankan Prime Minister representing SLFP: Aug-Nov 1994 and current President from 1994.
Naicker, E.V.R. ('Periyar') (1879-1973):	Indian Tamil reformist and politician. Established the 'Self-Respect league' in 1925 and DK in 1944.
Prabhakaran, V. (1954-):	Leader and one of the founding fathers of the LTTE.
Premadasa, Ranasinghe (1924-93):	Former Sri Lankan Prime Minister (1978-90) and President (1990-93) representing UNP. Assassinated by the LTTE.
Ramachandran, M.G. ('MGR') (1917-87):	South Indian actor turned politician. Founder of ADMK in 1972 - later AIADMK. Chief Minister in Tamil Nadu from 1977 till his death in 1987.
Vaiko, Shri (V.Gopalsamy) (1944-)	Indian Tamil politician and founder of MDMK in 1994. Former member of DMK.

GLOSSARY

<i>Agraharam</i>	-	A separate and exclusively Tamil <i>Brahmin</i> colony or habitation.
<i>Ahimsa</i>	-	Indian (Sanskrit) concept of non-violence.
<i>Aryans</i>	-	Population of Indo-European heritage who speak Sanskritic languages and who are understood to populate the dominant parts of North India.
<i>Asari</i>	-	Goldsmith caste or <i>jati</i> .
<i>Auto/auto rickshaw</i>	-	A small three-wheel vehicle used as taxi.
<i>Ayyappan</i>	-	Hindu deity. Son of Lord Siva and Mohini (a female representation of <i>Vishnu</i>). God of celibacy.
<i>Backward Castes</i>	-	Those whose ritual rank and occupational status are above ‘ <i>untouchables</i> ’ but who remain socially and economically depressed. Also referred to as Other Backward Classes (OBCs) or <i>Sudras</i> .
<i>Bhakti</i>	-	Devotion.
<i>Brahma</i>	-	The creator god of the Hindu sacred triad Hindu – see <i>Siva</i> and <i>Vishnu</i> .
<i>Brahmin</i>	-	Highest Caste or <i>Varna</i> in India. Traditionally priestly caste.
<i>Burgher</i>	-	Sri Lankan of Dutch ancestry.
<i>Churidar</i>	-	Female attire consisting of a tunic worn over pyjama pants, tight from the knee down and loose from the knee up. It is tied at the waist with draw strings. It is often worn with a ‘ <i>dupatta</i> ’, a long thin shawl draped over the shoulders.
<i>Crore</i>	-	Indian numerical denotation of 10,000,000 (written as 1,00,00,000).
<i>Dalits</i>	-	Literally meaning ‘broken’ people, a term employed by human rights activists to refer to ‘ <i>untouchables</i> ’.
<i>Deepavali (Diwali)</i>	-	The four-day festival of light. People decorate their houses, burst firecrackers and invite friends and neighbours to their households. People pay obeisance to the gods for having attained health, wealth, knowledge, peace, valour and fame.
<i>Dravidians</i>	-	Language family and people inhabiting the four southernmost states in India (Karnataka, Andhra Pradesh, Kerala and Tamil Nadu).
<i>Dravidianism</i>	-	Nationalist movement in Tamil Nadu where the Dravidians’ indigenous and autochthonous character was promoted to reclaim power which was allegedly lost to the <i>Brahmins</i> or <i>Aryans</i> from the north. Also referred to as the Dravidian movement and the Non-Brahmin movement.
<i>Dupatta</i>	-	Female attire: Long thin shawl.
<i>Ganesh(a)</i>	-	See <i>Pillayar</i> .
<i>Hawala</i>	-	An informal money transaction system.
<i>Jati</i>	-	Subcaste or subdivision of the four <i>Varnas</i> .
<i>Kannada</i>	-	Dravidian language spoken by the largest group of people in the south Indian state of Karnataka.
<i>Kannadiga</i>	-	Person from the state of Karnataka.
<i>Kannagi</i>	-	Heroine of the 1,500 years old Tamil epic ‘ <i>Silappadikaram</i> ’.

Karaiyar	-	Tamil fishing caste (<i>jati</i>) from northern Jaffna. Traditionally deep-sea fishermen and coastal traders.
Koolam	-	Chalk drawings in front of houses, which is an invitation to Lakshmi to enter and bring prosperity to the household. These are usually made, primarily by women in the early morning hours.
Kovil	-	Hindu temple.
Koviyar	-	<i>Vellala</i> domestic servants (<i>jati</i>), who are believed to be descendants of captured <i>Goigamas</i> – the Sinhalese equivalent of the <i>Vellala jati</i> . They are ranked as the <i>Vellala</i> 's ritual equals, but as their secular inferiors. They have no equivalents in India or among the Sinhalese.
Kshatriya	-	Second highest <i>Varna</i> . Traditionally warriors and kings.
Lakh	-	Indian numerical denotation of 100,000 (written as 1,00,000).
Loungi	-	Sarong for everyday use (see <i>Verti</i>).
Malayalam	-	Dravidian language spoken by the largest group of people in the South Indian state of Kerala.
Malayalee	-	Person from the South Indian state of Kerala.
Mahavamsa	-	Sri Lankan Chronicle probably dating back to the sixth century A.D.
Murugan	-	Hindu deity, son of Lord Siva. God of war. He is often depicted as a child and is one of the most important Gods of the Tamils, and often described as 'the' God of Tamils. He gives power and energy. Other names are <i>Subramaniya</i> , <i>Aiyanaar</i> , <i>Skanda</i> , <i>Guba</i> and <i>Karthikeya</i> .
Naxalites	-	Maoist revolutionaries consisting of several groups from different parts of India. They are reputed for their violent acts and assassinations of political opponents and class enemies. They are engaged in a militant struggle to achieve higher wages and more equitable land distribution.
Pillayar	-	Hindu deity, son of Lord <i>Siva</i> , appears with the head of an elephant. Remover of obstacles, and worshiped to attain success (in this life). Other names are <i>Ganesh(a)</i> , <i>Vinayagar</i> and <i>Ganpadi</i> .
Pongal	-	Tamil thanksgiving (<i>Thai Pongal</i>), but also a dish made from rice, sugarcane, ginger, turmeric and honey.
Pottu	-	The coloured spot used by Hindus on their forehead, which signifies the third eye of <i>Siva</i> .
Poonal	-	The sacred thread. Now primarily worn by <i>Brahmins</i> (in ancient times the <i>poonal</i> was worn by all twice-born <i>Varnas</i>). Worn over the left shoulder, across the chest and under the right arm.
Puja	-	Worship.
Q-branch	-	A special branch of the Tamil Nadu Police, established for the purpose of detecting and arresting so-called anti-national elements, movements or organisations such as the <i>Naxalites</i> and the LTTE.
Raj	-	Former British colonial rule of the Indian subcontinent.
Repatriates	-	Tamils of Indian origin who were imported to work in the tea estates in the Sri Lankan Hill country during the <i>Raj</i> , and who

were rendered stateless after independence. After agreements between India and Sri Lanka many were given Indian citizenship and returned to India.

Saivite	-	A worshiper of <i>Siva</i> .
Sakti	-	The female cosmic energy or power and the female principle of the universe. It is particularly associated with <i>Siva</i> . Within the Tantric tradition, <i>Siva</i> would be lifeless without <i>Sakti</i> .
Salwar kameez	-	Female attire: <i>Salwar</i> is a loosely worn pyjama-like drawstring trouser, and <i>kameez</i> , a knee long tunic like shirt.
Saree	-	Female attire: A length of cloth, measuring 13-26 feet long and about 4 feet wide, which is draped around the body. Most of the fabric is pleated at the waist and wound around to make a skirt, with the remaining swept across the upper body, covering at least one shoulder and sometimes veiling the head.
Satyagraha	-	Pressure for social and political reform through passive resistance against injustice based on non-violence (<i>Abimsa</i>) adopted and practiced by Mahatma Gandhi.
Scheduled Castes	-	An assemblage of socially deprived (<i>untouchable</i>) castes arranged by the British in 1935. The intended agenda was to increase representation of scheduled-caste members in the administration, in government employment, and in university placement.
Sudra	-	The Fourth and lowest <i>Varna</i> . Traditionally serfs and servants.
Sinhala	-	The principal language spoken by the Sinhalese.
Sinhalese	-	The dominant ethnic group in Sri Lanka, consisting of approximately 74% of the island's total population.
Siva	-	God of destruction and regeneration in the Hindu sacred triad – see <i>Brahma</i> and <i>Vishnu</i> .
Telugu	-	Person from the South Indian state of Andhra Pradesh and the principal Dravidian language of the Telugu people.
Thali	-	The gold pendant that signify the Hindu marriage. During the marriage ritual, the tying of the <i>thali</i> is the symbolic moment where the marriage is inaugurated.
Thavani	-	Female attire: blouse and half-sari.
Thevar	-	A powerful “ <i>Backward Caste</i> ” in Tamil Nadu.
Tiyakam	-	Concept of martyrdom employed by the LTTE, denoting a “voluntary abandonment of life” in the act of taking a life when encountered with the death of a comrade.
Untouchables	-	Those at the bottom of, or falling outside the caste system or the four <i>Varnas</i> . Administrative parlance now employs the term “ <i>Scheduled Castes</i> ” while human rights activists and the population more generally employ the term “ <i>Dalits</i> .”
Upcountry Tamils	-	Sri Lankan Tamils of Indian origin who are living in the central upcountry areas of Sri Lanka. Other designations are Estate Tamils, Hill Country Tamils and Sri Lankan Tamils of Indian origin.
Ur	-	Tamil conception of village or ‘place of belonging’ where people from the same <i>ur</i> are believed to share the substance of the soil.

<i>Vaishya</i>	-	Third highest caste or <i>Varna</i> in India. Commoners: Traditionally farmers, merchants, traders, craftsmen and herdsman etcetera.
<i>Varna</i>	-	Main Caste division (literally <i>colour</i>); strongly hierarchical, endogamous and hereditary which categorises people in accordance to birth, origin and occupation. The fourfold system comprises of: <i>Brahmins</i> (priests), <i>Kshatriyas</i> (kings and warriors), <i>Vaishyas</i> (traders and merchants) and <i>Sudras</i> (serfs and servants). The three former are regarded 'twice-born'.
<i>Vedda</i>	-	The 'aboriginal' people of Sri Lanka.
<i>Vellala</i>	-	Tamil farmer or cultivator caste (<i>jati</i>), found both in India and Sri Lanka. Consists of several sub-categories such as Kongu Vellalas and Sozhia Vellalas. Secularly the highest ranked <i>jati</i> in Tamil Sri Lanka.
<i>Verti</i>	-	Indian attire comparable to the sarong, made of a long cloth, frequently white and often with embroideries. It is wrapped around the waist, but differs from the colourful <i>lungis</i> by being longer, and by not being sewn together in the shorter ends. Contrary to the <i>lungi</i> which is worn for everyday use, it is a high-status attire. It is used on special occasions such as weddings, public meetings and other special arrangements.
<i>Vinayagar</i>	-	See <i>Pillayar</i> .
<i>Vishnu</i>	-	The preserver god of the sacred Hindu Triad. (See <i>Brahma</i> and <i>Siva</i>)
<i>Yakka</i>	-	Demon

Map of India

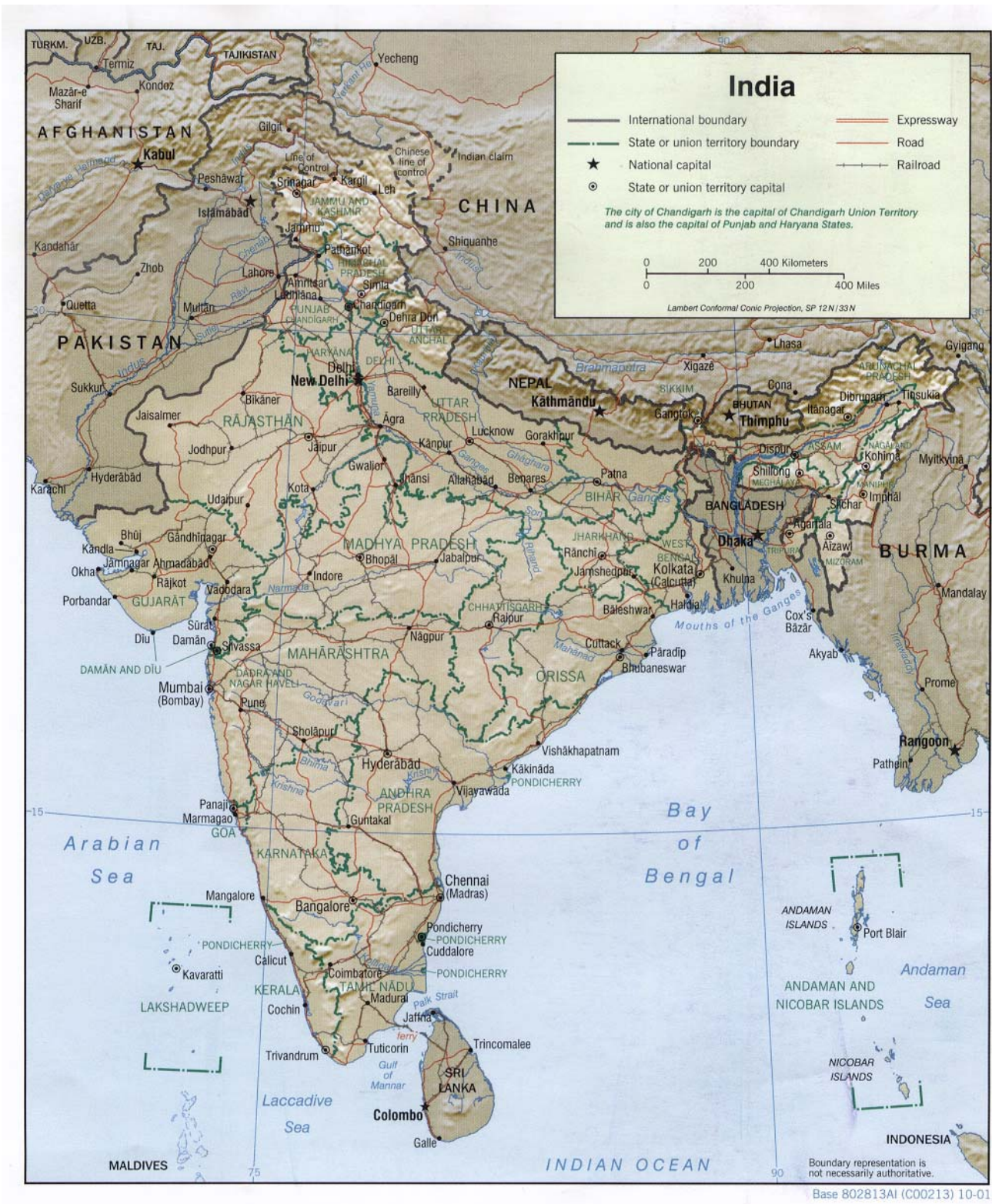

<http://www.lib.utexas.edu/maps/>

Chapter I – Introduction

This dissertation deals with the situation of the Sri Lankan Tamils who have settled in the South Indian state of Tamil Nadu, largely as a result of the Sri Lankans conflict. The influx of Sri Lankan refugees into the Indian Tamil-speaking state started in 1983. Decades of political tension and the Sri Lankan government's oppressing policy against the minority Tamils reached its zenith with the massive anti-Tamil riots in July 1983 in the Sri Lankan capital Colombo¹. The riots lasted for several days. An estimated 2,000 Tamils were killed and between 80,000 and 100,000 were displaced. This event plunged the country into an armed struggle between the government forces and various Tamil separatist groups. The Tamil dominated regions in the north and east of the island winded up as the battlefield of this conflict and the civilian population were severely affected by the war. In the initial years, the majority of the 60 million or so native Tamils on the Indian subcontinent were sympathetic to the victimised Sri Lankans who, due to the mounting conflict, fled to India. The refugees and the Tamil militant groups were also welcomed and supported by Indian Tamil politicians, of which the understanding of an 'ethnic kinship' between the Tamil populations of the two neighbouring countries was a central cause. But the good relationship gradually withered. It got its final blow on 21st May 1991 when former Indian Prime Minister Rajiv Gandhi was killed by a suicide bomber outside Madras in Tamil Nadu. The assassin was found to be from the *Liberation Tigers of Tamil Eelam* (LTTE), a militant group of Sri Lankan Tamil origin. This event challenged India's former political approach to the armed conflict on the island and its policy towards the Sri Lankan refugee population in general.

At the time of my fieldwork, an estimated 200,000 Sri Lankans were living in Tamil Nadu. Roughly half this population lived in refugee camps, while the other half lived in local communities mainly in the bigger cities. Some also lived in so-called Special Camps intended for militant Sri Lankans from the LTTE or other similar groups. My study deals primarily with the Sri Lankans who live outside refugee camps, but references will be made to the camp refugees and to the Sri Lankans in the Special Camps. This will sometimes be necessary

¹ While Colombo is the administrative and executive capital, the legislative and judicial capital is however Sri Jayawardenepura Kotte.

for comparative reasons but also to get a more extensive and complete understanding of the Sri Lankans' situation in India.

The main focus in this dissertation is towards the adaptation of the Sri Lankans as an exile community into the Indian Tamil society. Former studies on Sri Lankans in India, carried out by for instance V. Suryanarayan (1996), V. Suryanarayan and V. Sudarsen (2000), Fr.C. Amal Raj (1997), Bertram Bastiampillai (1996) and by the Refugee Council (1999) have principally had instrumental approaches, and have addressed notions such as the changed status of the Sri Lankans' after 1991 and the political measures implemented by the Indian authorities after the assassination. They have only briefly dealt with the Sri Lankans who live in the local communities, and almost exclusively with the camp refugees. As a consequence, Sri Lankans in local communities are commonly also understood to have integrated, with few problems, into their respective vicinities (see e.g. Bastiampillai 1996). A central approach in this dissertation, which largely has been left in abeyance by these studies, is the relationship, dynamics and conceptions prevailing between Sri Lankans and Indians in various local contexts. It should in this context be stressed that the relation between the two populations is of a highly multifaceted character. The Indian and Sri Lankan Tamil societies are represented by vast differences regarding social structure, caste formation, history and general standard of living, but the two Tamil people also share many cultural traits, such as language, religion and literature and commonly also a conception of ethnic affinity. The killing of Rajiv Gandhi transformed India's political approach on the Sri Lankan issue. But also the status of the Sri Lankans in India was considerably altered. From being regarded as the 'victimised kin' by the Indian Tamil population, the Sri Lankan Tamils were transformed into a community of 'potential terrorists' (see e.g. Amal Raj 1997, Bastiampillai 1996, Suryanarayan 1996, Suryanarayan and Sudarsen 2000). The relationship and mutual trust between the host population and the Sri Lankans in the local communities became strained. However, the assassination and its effects on the situation of the Sri Lankans have not been sufficiently explored. The need for a broader historical and political approach is important to understand the assassination and its consequences beyond its mere instrumental expressions and to get a more complete understanding of the situation of the Sri Lankans in India. First of all various disruptive events before 1991 need to be highlighted. So do the various political processes, formations, sentiments and agendas that have prevailed on national level in Sri Lanka and India and/or on state-level in Tamil Nadu. By encompassing these aspects, a more extensive

understanding of the status and situation of the Sri Lankans in India will be accentuated. The assassination of Rajiv Gandhi does not only constitute an integral part of these significant political and historical formations, but due to its comprehensive effects, it needs to be singled out, though not isolated in an historical approach. Special attention to the assassination will be carried out in the end of this thesis as a recapitulation of the situation of the Sri Lankans in India. This will be done here, as the analyses in the other chapters more easily can be taken into account.

In spite of this transformation which was a significant underlying factor for how people interrelated, local dynamics and practices, people's experiences and the nature of their interactions nevertheless appeared to be perceived as more important for how people acted and related towards each other. An important factor affecting these local dynamics, and which represents a central focus in my dissertation was the comprehensive wealth of many Sri Lankans in India. Following the extensive displacement resulting from the conflict, many have family networks that extend far beyond Sri Lanka and India, to the West, Middle East, South East Asia or Australia. These relations are of great significance for the economic subsistence of many Sri Lankans in India, but are frequently also a source of tension between the Sri Lankans and the Indians. The importance of these family networks for the Sri Lankans necessitates an approach that transcends the conception of localities as bounded and fixed. A significant task in my dissertation will be to illustrate how trans-national networks and economic remittances have influenced the lives of the Sri Lankans in India and their relationships with the host population. While extending my focus beyond the local communities in which the Sri Lankans reside, I will include a focus on the situation of the camp refugees, as well as on the association with people in other geographical domains such as Sri Lanka and various Western countries. Most Sri Lankans in the local communities have at one point resided in a refugee camp, and many of my informants have such trans-national family networks that in various ways, materially as well as relating to values and morality, influence their situation in India.

Another factor of the works of V. Suryanarayan (1996), V. Suryanarayan and V. Sudarsen (2000), Fr.C. Amal Raj (1997) and the Refugee Council (1999) are their tendency to particularise. As stated above, they do not pay much attention to the Sri Lankans who live in the local communities, or to the importance of trans-national family bonds. But when these

Sri Lankans are referred to, the aspect of trans-nationality is barely considered beyond its mere economic dimensions (see e.g. Bastiampillai 1996). As the Sri Lankans in India are part of a greater diaspora, and as people also continuously move to and fro India, the West and frequently also Sri Lanka, this dissertation reflects on dimensions which also are significant when considering Sri Lankans in other countries.

In this dissertation, I thus employ a wide-ranging spatio-temporal approach which will firstly, take into account wider historical and political formations that are significant to understand the current situation and status of the Sri Lankans, and secondly, focus on various domains which relate to or influence, directly and indirectly, their situation and relationship to the local Indian population. Broadly speaking, while maintaining this spatio-temporal approach, I will have a three-fold focus. I will look at local dynamics that relate to identity formations and negotiations, trans-national issues that address the effects of being part of a larger diaspora, and finally political and structural formations that deal with the effects of the assassination of Rajiv Gandhi on the Sri Lankans in India. While relating to these aspects, former events or political formations, individual and collective, will be emphasised. I will thus stress the need to address identity formations within a broader historical and geographical framework. In contrast to most other approaches that have been undertaken earlier. As should be evident, and which also will be apparent throughout my analysis, the approaches on identity, trans-nationality and social transformation are highly interrelated and cannot be considered independently from each other, but it is necessary to disentangle these analytically in order to explore the complexity of the relationships and the specific dynamics at work.

THE FIELD OF RESEARCH

My research was conducted during a 10 month period, from May 2000 to April 2001, primarily in a relatively large city in Tamil Nadu which I have named Akhadipuram², but partly also in other cities. I lived in one of Akhadipuram's suburbs, Raja Nagar, which has a significant Sri Lankan population. Names of places, such as Akhadipuram and Raja Nagar, as well as the names of my Sri Lankan and Indian informants are fictitious in order to protect their identity. The situation of the Sri Lankans has changed a great deal since my fieldwork. Following the ceasefire and the instigation of the peace process between the Sri Lankan

² "City of refugees".

government and the LTTE, many Sri Lankans have returned to the island. However, this thesis will not include the changes that have taken place in Raja Nagar after the ceasefire was initiated in December 2001.

OUTLINE OF CHAPTERS

This thesis is broadly divided into a contextual and an analytical part. In the three preceding chapters, various contextual subjects will be presented. These are necessary for the following more analytically oriented discussions. I will begin by presenting the historical background of the Sri Lankan conflict, significant nationalist movements in the two countries and the historical relationships between India and Sri Lanka. Such an approach will shed light on significant aspects of their refugee situation. The assassination of Rajiv Gandhi which came to redefine the Sri Lankans' status in India must be understood in the light of these historical factors. The next chapter will concentrate on local formations relating to the settlement and habitation of the Sri Lankans in India, and certain structural formations such as immigration regulations and refugee policy which are of significance for their situation. Finally in this first part, I will present important fieldwork matters and methodological challenges that I had to face during my research. Many of these aspects also mirror difficulties that the Sri Lankans were facing in their daily life in India. The following four chapters will represent the analytical part of my thesis. I will start with a local focus by looking at the local situation of Sri Lanka and India. I will address processes that involve the situatedness of the Sri Lankans in India, their association with the host population, and also internal dynamics and identity formations within the Sri Lankan community. I will then expand my focus by looking at migration and trans-national networks and at the impact of remittances and negotiations of values and ideas between local communities and diaspora networks. In the last chapter, I will address the Sri Lankans' situation on a structural level. I will pursue a comprehensive approach on the assassination of Rajiv Gandhi in order to elucidate its fundamental impact on the situation of the Sri Lankans in India. Its effects permeate the daily life of the Sri Lankans in significant ways, and influence the everyday practices and comprehensions of the Sri Lankans. I will now give a short presentation of each of my chapters, before moving on to present the main theoretical approaches in this dissertation.

In chapter two, I will give a presentation of the nationalist movements in Sri Lanka (Sinhalese and Tamil) and Tamil Nadu and explain their emergence. I will also locate these within the

context of societal transformations that took place during colonial times. Moreover, I will describe the historical development of the Sri Lankan armed struggle, as well as India's role and agenda in this conflict. This is eventually important when relating to the assassination of Rajiv Gandhi and its severe consequences for the Indo-Lankan relationship and the situation of the Sri Lankans in India. A historical focus on the Sri Lankan conflict, India's role and various nationalist movements are significant for understanding the Sri Lankans' current situation in India. It will be made evident that the situation of the Sri Lankans in India already was strained before the assassination in 1991, and thus that the problems that the Sri Lankans encountered and experienced in India during my fieldwork cannot solely be traced back to the killing of Rajiv Gandhi. The other factors outlined in this chapter represent an important framework for understanding the complexity of the Sri Lankans' situation in a historical perspective.

In chapter three, I will introduce the various categories of Sri Lankans in India, those who reside in the local communities, the camp refugees and the militants who live in the Special Camps. As an analysis of the Sri Lankans outside the camps will be conducted throughout this dissertation, special emphasis will be given to the camp refugees in this chapter. Their situation is important for comparative reasons, and will also be referred to in following chapters whenever relevant. I will also give a presentation of India's refugee policy, and by this, elucidate the legal status of the Sri Lankans in India. This will shed light on the execution of India's restrictive policy towards Sri Lankan refugees which for instance will be well illustrated in the initial parts of the chapter. Here, I am going to present the Sri Lankans' flight by boat to India and how India strive to curb this influx by various means, such as by imposing a naval block and by confiscating the boats of fishermen who help the Sri Lankans to land on Indian soil. In the last part of the chapter, I will give a brief presentation of Raja Nagar, which was the prime location of my research. This will include a short introduction to the place, of the people who live there, their origin and aspects of social life.

Chapter four deals with methodological challenges that I encountered while conducting my fieldwork and which in various ways influenced the processes of data collection and eventually how I carried out my research. Here, I will present my proceedings in trying to adapt into various environments which were of significance for my research. This involves how I approached practical aspects such as getting in touch with people, how I collected my

data, and how I dealt with language barriers. As a man, acquiring women as informants was an additional challenge which had to be taken into account. I also experienced comprehensive problems relating to trust, as I operated in a highly politicised environment where fear and suspiciousness were predominant. Under such circumstances, the notion of anonymity became crucial. Also, I will emphasise the problem of conducting a fieldwork in a relatively geographically limited space while at the same time relating to the Sri Lankan Tamil community which is highly trans-national in its family organisation and dynamics.

Chapter five will deal with the local relationship and the construction and negotiation of identities among and between Sri Lankans and Indians in Raja Nagar. It will be important to present people's ideas about the other, but also to stress the internal complexity within the Sri Lankan community. It will therefore be important to clarify the diversity that relate to caste and place of origin within the Sri Lankan community, but also to illustrate how people negotiate, manipulate, and under-communicate certain identities, often to avoid unwanted categorisations from the Indian population. A central factor in this chapter is fear and the new detrimental status that the Sri Lankans obtained after the assassination of Rajiv Gandhi. In this context, it will be imperative to look at how the Sri Lankans came to comprehend their new status, and how media and certain government institutions play a significant role in reproducing such conceptions. Lastly, I will discuss the importance of local dynamics and experience, aspects that people relate to in daily life and which thus are significant for comprehensions and identity negotiations in a local context such as Raja Nagar.

In chapter six I will move to aspects relating to the trans-national family networks. First of all, it will be important to identify the Sri Lankans who have relatives living abroad from whom they receive economic remittances, as well as their settlement patterns in India. This is important in order to identify internal differences within the Sri Lankans community, not only relating to wealth but to how people make their living. While many Sri Lankans in Raja Nagar own large houses and exhibit an impressive wealth due to their trans-national remittances, others with families overseas are struggling to subsist. Such differences may to some extent be explained by considering the time of migration of these relatives in relation to differences in immigration laws in countries in the West, and to the costs involved in performing a journey abroad at different times. In the last parts of this chapter I will seek to investigate the local consequences of trans-national remittances on the local development and

economy in Raja Nagar, but also to look at the exchange of values and ideas between different geographical domains. As we will see, the exchanges of values and material goods have different consequences and produce different interpretations among the people who perceive these transactions. The general dislike of India and the difficulties that many Sri Lankans encounter in this country, mixed with the material wealth displayed by Tamils with relatives in the West often generate an eagerness to migrate among the Sri Lankans in Raja Nagar.

Chapter seven also deal with migration, but will have a more extensive focus on people's experience and the actual process of migration. By means of two empirical cases I will present the preparations and the potential problems and dangers that people may encounter when planning a journey further abroad. The two cases represent two recurrent but different modes of arranging and performing a journey to the West. In the first case, the journey is done legally and by way of marrying someone who already lives in the West, while the second is done illicitly by means of an agent and forged papers. As we will see, the first mode involves a long a strenuous process, but is safer. The other one can be organised and performed rather hastily, but as will be evident, an illegal journey may also be dangerous. It will also be imperative to emphasise, in the first case, the emotional distress involved in leaving a country where one has lived the greater part of one's life, and in the second, the distress of being left by a child and the additional stress of having this child imprisoned in a foreign country for having entered this country illegally. As we will see, such journeys may also be extremely expensive. An additional aspect which will be emphasised is the exploitation of girls by Tamil men living in the West who come to India on the pretext of finding a wife. Their fervent aspiration for a good life in the West is frequently exploited.

Chapter eight deals with the extensive impact of the assassination of Rajiv Gandhi on the Sri Lankan population and community. The discussions elaborated upon here are central for understanding the complex situation of the Sri Lankans in India. The argument in this chapter will be three-fold. I will start by presenting the tangible political consequences of the assassination which must be seen in connexion with the discussions in chapter three. Some of the consequences which will be dealt with are the banning of the LTTE, the inauguration of a repatriation programme for Sri Lankans, the banning of NGOs from working with Sri Lankan refugees and the initiation of an extensive practice of monitoring Sri Lankans to

detect and arrest LTTE people. The consequences for the Sri Lankans will subsequently be discussed and deals primarily with the emergence of corruption, extortion and fear among the Sri Lankans due to the demonisation of the Sri Lankans that emerged following LTTE's association to the assassination. In the second part I will direct my attention towards the assassination itself and to why this event, as compared to other damaging incidents, came to have such dramatic consequences for the Sri Lankans. In the third part of this chapter, I will focus on the transformation of the Sri Lankans within what I deem a national discourse; the concept understood in Michel Foucault's (1980, 1999a, 1999b) terms. His notion of power is also of imperative importance in the third part, as I aspire to identify how this transformed national conception of the Sri Lankans was incorporated in all parts of Indian society, as in the effectuation of Indian Tamil politics. I will argue that this transformation had a disciplining effect, where people systematically subdued and under-communicated aspects related to the LTTE to avoid sanctions. Finally in this chapter, I will present the Sri Lankans' view on the assassination, and how they questioned the official version of the event as a mode of resistance against the experienced repression by the Indian state.

CENTRAL THEORETICAL APPROACHES

This dissertation will include a range of theoretical approaches with which to explore the ethnographical material at hand. These will be thoroughly addressed in the various chapters where these theories are relevant, but I will give a brief introduction to the most significant underneath. These theories largely relate to how people generate meaning and negotiate identities by means of their practices, the influence of trans-national bonds on their situation, as well as the importance of power formations for people's local lives. The phenomenological theories which discuss the production of meaning, either by means of actions in the world, or through the interpretation of actions or signs, will have a central position in chapter five which deals with identity constructions and local dynamics in Raja Nagar. These theories will also variably be employed in other chapters, such as chapter eight when referring to the assassination of Rajiv Gandhi as an event that, in a phenomenological sense, produces meaning in the world. Theories on migration and diaspora are central in chapter six which is concerned with the trans-national relations and influence. As already mentioned, a Foucauldian approach to power is central in chapter eight which deals with the assassination of Rajiv Gandhi and its implications on Tamil Nadu politics and on the lives of the Sri

Lankans in India. Though his theories primarily will be elaborated upon here, it will also be referred to throughout this dissertation.

Many of these theories concern relational aspects of human life and relate to people's understanding of themselves in their environment and on how people meet and conceive of persons who in one way or the other are significant for them. Based on the thinking of the Austrian theoretician and phenomenologist Alfred Schutz (1970), I will use the notion of 'fellow-men' to describe these significant people. Schutz is concerned with our 'life-world', which represents the totality of our actions, orientations and experiences. Our 'life-world' is fundamentally intersubjective as it is intrinsically linked to our 'fellow-men'. He combines our subjective experiences with our prestructured understanding of the world based in socialisation and our efforts to understand the world around as a basis for actions and behaviour. His theories will be central in chapter five which deals with local constructions and negotiations of identities and people's local experiences. A phenomenological approach to significant events and to the life of the Sri Lankans, as emphasised by Schutz, will not only focus on events and actions as they are manifested for people, but more fundamentally how they create meaning through actions, and how they construe, understand and are affected by their environment. Hence, the Indian Tamil anthropologist Arjun Appadurai (1995) emphasises the material effects of human activities, and in this context distinguishes between *locality* and *neighbourhood* which represent different dimensions of spatial association. While neighbourhood refers to situated communities and actual social forms, locality is not spatially contained but has a phenomenological relational and contextual dimension where meaning and coherence is produced through actions and performances. Such actions may be represented by ritual processes, naming of places, acts of violence or by any other actions with the inherent potential to colonise places and transform the meaning of a place. A phenomenological focus, as accentuated by Schutz and Appadurai, encompasses people's actions both upon and within the world. Such an approach will thus not only have a prominent position in chapter five which deals with identity negotiations, but also in chapter eight which is concerned with the assassination of Rajiv Gandhi. Appadurai's theories are useful when considering the assassination's transformative potentials and as a meaning producing event. As locality involves a dimension of human activity, this notion embraces fluidity and changeability in a local context. This will be significant when approaching the effects of people's actions, as well as change and transformation as a dimension of the Sri

Lankans' situatedness in India. The transformative dimension is especially relevant when considering the underlying repressive formations that emerged as consequences of the assassination of Rajiv Gandhi as such formations influenced people's daily life and behaviour in significant ways.

How people present themselves and interpret their social environment, for instance in the process of negotiating identities, will also be examined in chapter five as a dimension of the production of meaning. It will be important to approach how people actually perceive and interpret significant signs that are presented to them, and how they perceive their environment or 'fellow-men', but also to grasp the specificities of the produced interpretations. As will be evident in chapter five and eight, meaning is not only created through actions, but interpretations of signs also produce effects upon the world. Interpretations may deviate from, or be transformations of the meanings which an action was intended to produce with a receiver, but a sign may also be unintended or unconscious and still produce comprehensive effects with the receiver. Furthermore, interpretations may be born out of prevailing political situations such as the context of the assassination of Rajiv Gandhi. Charles Sanders Peirce's semeiotic theory will be appropriate to understand this process. E. Valentine Daniel (1984) and Daniel Heradstveit and Tore Bjørgo (1996) describe his semeiotic triangle which represents the core of Peirce's theorisation. It consists of a sign or *representamen*, the interpretation or *interpretant*, and the *object*. The interpretant is first of all not the interpreter but the idea which is produced with the receiver of the sign. It is different from the initial sign, and does not need to refer to the initial object which the sign represents. The sign may also be understood by employing or referring to other signs. Once a sign is interpreted, it becomes a new sign, which again may become a new interpretant, etcetera. A sign exercised by a Sri Lankan (which may be a physical act or any other performance that may produce effects in the world, but also bodily traits and features) may be interpreted in a specific way by an Indian interpreter relating to the context or political circumstances in which they engage, which in itself also is a sign. The interpretant is in this sense determined and enforced by the correlation of several signs. To put it in another way, this sign would, if expressed by another Indian or by someone of another nationality and in another context, not produce the same effects. Peirce's theory do not only take into consideration people's actions and expressions, but also the effects of people's actions and expressions in the world,

as well as it incorporates additional relevant formations and contexts and interpretations by their 'fellow-men'.

Another theoretical approach which will be important in the chapter on identity and local life, but also in chapter six and seven which deal with migration and the recurrent divergences between 'traditional' and 'western' values, is that of Katherine P. Ewing (1990). Her concept of 'shifting selves' is relevant when considering the negotiation of practices between people, on how people understand themselves in relation to their environment and their 'fellow-men', and on how they are interpreted by others. The way in which people present themselves and act may be ambiguous and full of apparent contradictions. She argues that people operate with different but nevertheless equally important selves which may have different and mutually inconsistent value systems. These different selves will be expressed under different circumstances, depending on context and on whom people engage with. Such 'selves' are perceived as fundamental and totalising for the person in question at the given time of an action, but are from the outside often interpreted contradictory and inconsistent. This is an important dimension of the production of meaning, as it sheds light on people's frequent conflicting motivations and aspirations as well as the complex and seemingly contradictory feelings that Sri Lankans may have about their habitation in India. It is in other words important in people's processes of negotiating identities, but also in the context of migration when the West is variably depreciated and construed as morally corrupted, while in other contexts highly approved of as a place with great material possibilities.

How people produce or negotiate meaning in their environment relate to their identity constructions, in establishing an understanding of who they are in their environment in relation to their 'fellow-men'. Identity, the central notion in chapter five, deals with the establishment of coherence between individuals and between individuals and groups. This social dimension of human behaviour relate to group formations. The theories of Fredrik Barth (1969) and Richard Jenkins (1996) will be emphasised in this context. As cultural formations are not fixed but constantly in flux and continually under a process of negotiation, Barth and Jenkins evade a focus on the cultural content as the nucleus of ethnic formation. Instead of seeing identity and ethnicity as something primordial and given, they emphasise identity negotiations as being performed at the boundaries between groups. For instance, the large internal differences among Sri Lankans in India tend to be ignored to the advantage of a

national identity. Barth and Jenkins argue that significance is established by means of processes of categorisation and self-ascription. Internal ascription is important for people's feeling of affiliation within a group. The feeling of being a member of a group, Barth argues, is more important than whether the members actually share cultural traits or not. Jenkins on the other hand, is more concerned with external categorisation as defining for the construction of identities and the power inherent in the process of labelling and classifying others. Again, the process whereby the Sri Lankan community was demonised after the death of Rajiv Gandhi was constitutive for how Sri Lankans comported themselves in an Indian context. That is, this violent external categorisation strengthened the Sri Lankans' internal group association. These processes of categorisation and group identification are significant as they relate to people's organisation of their lives, how they relate to their 'fellow-men' and how they engage in their 'life-world'. All the above-mentioned theories are central in chapter five, and to a varying degree also in other chapters in this dissertation. But as Sri Lankan identities also must be seen in a trans-national context, which are the focuses of chapter six and seven, it is important to approach identity beyond its local expression.

This brings us up to the level of trans-nationality. Notions of diaspora and migration will be employed in chapter six to accentuate this dimension and its relevance for the Sri Lankans' situation in India. Diaspora is usually associated with populations which are seen to be displaced from their country of origin, and the connexion between this group and their conceived homeland. This notion is significant as it deals with ideas of belonging and identity formations that exceed national borders. It also transcends the rigid conception of places as geographically bounded and dynamics as limited to specific domains. It is thus beneficial in the context of the Sri Lankan Tamils as it incorporates, first, the diversity that exists within a community across nation-states and, secondly, the influence of trans-national dynamics on identity formations. Theorists have approached the concept of diaspora in a variety of ways. Some, such as William Safran (1991) and Robin Cohen (1996, 1997) maintain an objectivist approach and present various criteria to determine whether a population can be deemed diasporic or not. Post-modernists such as James Clifford (1994) and Arjun Appadurai (1991) disagree. They argue that cultural boundaries are fluid and that people live in a cultural universe which transgresses national boundaries. They focus on ethnic hybridity and see identities as trans-national and constructed in an increasingly globalised and deterritorialized world. Appadurai emphasises the power of the imagination and focuses on the wide range of

possibilities and potential lives which are made evident through mass media. These are all important aspects when relating to the Sri Lankans in India. But the multifacetedness and complexity of this community is nonetheless more extensively considered by the Greek Cypriot academic Floya Anthias (1998). She is concerned with movement, but also incorporates the intersectionality of various processes in her theorisation on diaspora. She argues that many and often contradictory identities and processes of categorisation act at the same time. She focuses on local complexity and how notions such as gender, class and power are subject to change within the group as well as in relation to the host community resulting from diasporic connexions. This approach incorporates changing identities and influences and problematises the notion of a collective 'we'. Anthias' approach is useful in shedding light on the complex nature of Sri Lankan habitation in India and the existing divergences within the community relating to notions of belonging, identity constructions and how people relate to their Indian environment. It also takes into account the conjoint influence of various significant domains, which is crucial for understanding the situation of the Sri Lankans in India. The domains which the Sri Lankans relate to and also construe include, India, as the place they live, Sri Lanka, where they are from and to where they normally wish to return, and possibly western or Middle Eastern countries, where they may have relatives who support them economically.

Migration theories, another central notion in chapter six, on the other hand deal with the factual consequences of migration on the sender and receiver communities. I will primarily refer to by Michael Kearney's (1986) presentation of these theories. The material and social consequences of the trans-national bonds on the relationship between the Sri Lankans and Indians are interrelated and cannot be considered separately. People's material situation affects how they are perceived by others, but also their activities and behaviour in their environment is affected by their affluence. Wealth obtained through remittances generates ideas and trigger people's imagination about other possible lives, but may also be a source for jealousy. Material wealth related to migration thus has a meaning-producing dimension. The first approach to this is the modernist view, which is concerned with the effects of remittances on the local sending communities. It is attentive to the individual decision maker and maintains that migration leads to local development and economic growth. The Neo-Marxist dependency theory has the opposite approach as it argues that migration benefits the urban centres, and that its consequences are extraction of economic surplus and capital from

the sending communities. An offspring of this theory is the world system theory, which, like its forerunner postulates a global capitalist system. It also consents with the former by suggesting that it is the centre which profits from migration, but is nevertheless more concerned with the complex dynamics of rural migrant labour in the urban centres. The absence of a focus on cultural formations in this approach is overcome by the articulation theory. This approach is more open to economic dynamism as it is concerned with different modes of production that may exist in different domains. Articulation theorists argue that the appropriation of surplus must be analysed where production is conducted. It thus integrates local modes of production in India with external forms, for instance in the West, and consider their interrelatedness. A trans-local focus also elucidates the complexity within the Sri Lankan community in India in relation to modes of income and the various effects of remittances on the relationship between the Sri Lankans and the local Tamil population. Theories on migration and diaspora incorporate different dimensions of trans-nationalism, material and social aspects respectively, but which are complementary. The material aspects of migration have clear social consequences on how they are viewed by the Indian population, how Sri Lankans perceive their situation in India and how they negotiate their practices with the Indian host population. Finally, the notion of power emerges as crucial as it permeates the Sri Lankans' situation in India when considering the impact of the trans-national dimension, the local negotiations and constructions of identity, how people define their situation in an Indian context, and also how the Sri Lankans are perceived by their Indian Tamil counterparts.

As stressed initially, a consequence of the assassination of Rajiv Gandhi was the collective demonisation of the Sri Lankans and their transformation into a community of perceived potential terrorists. This was accompanied by an increasing negative attitude by the Indian population. In response, a growing suspiciousness among the Sri Lankans emerged towards the host population. Surveillance of the Sri Lankans by the government also generated heightened alertness and fear as such practices often were accompanied by corruption and extortion by Indian officials. As will be represented in chapter eight, the dimension of power is highly evident when considering the Sri Lankans in India. But so is the need to consider power beyond its more classical denotation where someone, by means a sovereign or hierarchical position, can impose their will on others. An instrumental approach to power does for instance not explain why the Sri Lankans' behaviour may be constrained or limited

due to fear and suspiciousness towards their entourages without actually being in contact with people of authority. The French social philosopher and historian Michel Foucault (1980, 1999a, 1999b) is concerned with the discursive and disciplining dimension of power. But it is first important to understand Foucault's concept of discourse of which power is an intrinsic aspect. Discourse refers to a social construction of reality where sets of practices form the objects of which they speak. Such practices can be seen as rule-governed structures where certain forms of behaviour are considered legitimate or 'normal' which again direct or discipline people to act in given ways. Conceptions or actions which diverge from the logic and order of a discourse, or of its notion of normalcy, are regularly considered deviancies. Such deviancies may be reacted upon by means of a whole set of internal and external techniques, procedures and levels of application which by effect disqualifies the legitimacy of these activities. Discourses are not imposed by figures of power, but have instead emerged out of complex political formations and historical processes with different relevance at different times. These are internalised and taken for granted by people. Foucault does not consider power as localised, but as structural, relational and circular. Power is entrenched in the nature of people's relations, it is taken for granted, embodied and ingrained in people's bodies and thus structure people's actions. That is, by acting within the order and logic of a discourse and by embodying its conceived concepts of normalcy, people discipline their own practices. The Sri Lankans in India reproduce these repressive structures through their actions, which in effect imply both the undergoing and exercising of power. However, the instrumental notion of power, that which is exercised from a localised centre, should not be neglected. It should instead be seen as intrinsic to the Foucauldian view of the notion. The Sri Lankans were indeed victims of direct sanctions imposed by the Indian state, but their actions and comportment were also disciplined and constrained by a fear for such sanctions or for surveillance, extortion or for being linked to the banned LTTE. This disciplining was crucial for their local comportment. That is, power permeates the negotiation of local practices, the identity formations of the Sri Lankans and their relationship to the host population in fundamental ways. In this context, these power formations also had an influence on how many Indians comprehended and acted towards the Sri Lankans.

This dissertation thus seeks to explore the situation of the Sri Lankan Tamils in India within a broader spatio-temporal framework. Hence, a focus on their situation will involve broader politico-historical processes and formations which in various ways have influenced their

situatedness in India. This will incorporate various forms of influence from domains which exceed the local communities wherein they reside. This includes for instance the ordinary and 'Special' refugee camps in Tamil Nadu and other geographical domains such as Sri Lanka, countries in the West and the Middle East. By addressing notions of identity, migration and social transformation in a spatio-temporal light, I seek to present a fuller understanding of the Sri Lankans situation in India than what has been done so far.

CLARIFICATIONS OF NAMES AND CONCEPTS

Conclusively, certain practical issues should be elucidated. First of all, the situation of the Sri Lankans in India was decisively different at the time of writing than at the time of my fieldwork. The inauguration of the peace process and the ceasefire agreement of December 2001 have led thousands of Sri Lankans to return to the island. The influx of refugees from Sri Lanka has largely ceased, and the regulated movements between India and Sri Lanka for Sri Lankan Tamils have been relaxed. Former inaccessible war-torn areas in Sri Lanka have also been made accessible which have led a number of Sri Lankans in India to establish import and export businesses between the countries. Family members in India and Sri Lanka who have been separated by the conflict, and who have not received news from each other for a long time have now been able to re-establish contact.

Certain concepts and denominations which may seem confusing for the reader should also be clarified. In the text, I will operate with many 'categories' of Tamils. Unless stated, 'Sri Lankans' will refer to the Sri Lankan Tamils who live in the local communities, or outside refugee camps. When I attend to Sri Lankans who live in camps or in 'Special Camps', this will in other words be specified. The notion Sri Lankan Tamils will comprise of Sri Lankan Tamils from Jaffna, Colombo, from the East Coast, as well as 'Upcountry Tamils'. The latter 'group' goes under many names, and are descendants of Indian Tamil labourers imported for work in the tea plantations in the central hills in Sri Lanka from about 1825. They are commonly referred to as Upcountry Tamils, Hill Country Tamils, Estate Tamils, or Sri Lankan Tamils of Indian origin, but I have chosen to use the notion 'Upcountry Tamils'. They are commonly separated from so-called 'native' Sri Lankan Tamils, from Jaffna, the east or Colombo, something I will generally not do unless specified. Furthermore, 'Repatriates' are Upcountry Tamils who have received Indian citizenship as this population was rendered stateless in Sri Lanka after independence. When referring to Indian Tamils, this concerns the

60 million or so native Tamils from India. Ceylon, Sri Lanka's former name, will be used when referring to historical events prior to 1972, when the country was renamed. Madras has been preferred before Chennai, which has been the city's name since 1996. I have done this as most of my informants still used the name 'Madras' when referring to the city.

Chapter 2 – History and nationalism as premises for contemporary adaptation

INTRODUCTION

The current status and situation of the Sri Lankans in India cannot fully be contemplated without also focusing on significant historical events and political formations. I will start by emphasising the Sinhalese and Tamil nationalist movements in Sri Lanka as these are necessary to understand the evolution of the Sri Lankan conflict from which the Tamils from the island-state have fled. I will also focus on the simultaneous, though not entirely analogous Tamil nationalist movement in Tamil Nadu as a means for understanding India and Tamil Nadu's stands and political responses to the Sri Lankan conflict and to the island-state's repressive policy against its Tamil minority. In a similar way, India's interventionist policy towards Sri Lanka must be seen in relation to its role as a regional superpower and to cold war formations. It is necessary to look at the ideological background for these nationalist movements in order to understand the emergence of the Sri Lankan conflict, and the way in which this conflict has shaped the Sri Lankans' situation in India. Indian and Sri Lankan Tamil and Sinhalese nationalism must be understood in relation to the colonial transformation of the Indian and Sri Lankan societies. The impact of the British *Raj*³ on their colonial subjects, though in Sri Lanka more than India due to its smaller size and less complex social structure, was tremendous, socio-economically as well as discursively. They institutionalised 'Western' value systems and concepts of knowledge, science and history. An elite with strong colonial sentiments educated within a colonial schooling system were central in establishing and reproducing these ideas. For instance, and as will be elaborated on beneath, the use of ancient texts and chronicles and the interpretations of pre-colonial Sri Lanka in these nationalist discourses emerged out of adopted colonial concepts of history and racial classification.

After having located the development of these nationalist movements, I will present the historical development of Sri Lanka after independence, with focus on the alienation of the

³ The former British colonial rule of the Indian subcontinent and Ceylon.

Tamils, the emerging conflict, and India's ultimate involvement. After this, I seek to identify the role of the Indian Tamil Dravidian nationalist movement and Indian national politics on Sri Lanka and the conflict. The political formations leading up to 1991, where this chapter ends, is of importance for the analytical chapters later in this dissertation. Many disrupting events between 1983 and 1991 severely affected the relationship between India and Sri Lanka, but also the status of the Sri Lankan community in India. As we will see, the situation of the Sri Lankans in India was already severely strained when the assassination took place, and many of the disruptive events prior to the assassination were emphasised by both Indians and Sri Lankans as reasons for the difficult relationship between the two populations. This chapter is thus important for understanding the background, not only of the Sri Lankan conflict and for reason of the Sri Lankans' flight, but also for the difficult relationship between the Indians and Sri Lankans in various local communities. It is also significant for understanding why the assassination came to have such dramatic consequences, a discussion I will pursue in chapter eight after having discussed and established various significant aspects relating to dynamics on local level.

THE BRITISH RAJ AND THE 'REINVENTION' OF CEYLONESE SOCIETY

The British took over as overlords of the island in the 1790s. Of the three European colonial rulers of Ceylon, the British seemingly intermingled and integrated themselves the least with the local people and communities. Especially the Portuguese, but to a certain degree also the Dutch integrated rather well into the Ceylonese society. However, the British Raj had the greatest impact on the Ceylonese civil society as it was able to effectuate a considerable transformation of the society, not only on a structural and socio-economic level, but also more fundamentally relating to ideology and value systems. The British Raj was also a time when the local population was able to expand their horizons and where their social commingling developed to be more dynamic than it had been before.

The British created a substantial infrastructure with roads and railways, in order to develop and effectuate the trading and the import-export economy. They introduced a plantation economy where the hostile and malaria infected central hills were transformed into blooming spice, rubber and coffee plantations. The coffee was later abandoned for tea, which still

remains the cornerstone of Sri Lankan economy. The British imported Tamil labourers from south India, mainly of low-caste origin, to work on the plantations. By the British, the Upcountry Tamils, as they came to be known, were regarded as hard workers with few requirements concerning wages and food, but they were disapproved by the high-caste Ceylonese Tamils, who saw them (and treated them) as inferiors due to their low caste status. The British also introduced an English-based educational and bureaucratic system, but as in Burma and India, ‘minorities’ were preferred in these institutions. In the case of Ceylon, this meant the Tamils. The result of these colonial processes, as ‘western’ education and commercial enterprises, was the rise of an ethnically mixed elite which also acquired control when the British left the island. The migration during the later stages of the British Raj and right after independence represented the first stage of ‘modern’ Sri Lankan migration. Common for this group of Sinhalese, Tamils and *Burghers*⁴ were their belonging to the upper- or upper-middle-class. They were western-educated and were at ease with western ways and tastes. Class identity was a central feature of identification for them, and invariably, the Tamils belonged to the uppermost *Vellala*⁵ *jat*⁶ (Daniel and Thangaraj 1995)⁷. Their habitation in the West eased later processes of migration though they largely differed, especially in class but also to a certain extent in caste origin from the later migrants.

A central impact of the British was that they were able to ‘reinvent’ and reconstruct Ceylonese peoples and pasts by means of consolidating and infusing ‘western’ value systems and historical conceptions into the Ceylonese society. Much of this was due to the large western educated elite who were active in elevating these values to a dominant one. Like in India, the British wrote down, measured, classified and charted what they understood to be the diverse composition of Ceylonese society, based on occupation, religion, caste and race (Rajasingham-Senanayake 2002). Much on the basis of ancient texts, they understood the concept of caste to be based on the system of *Varma* – a rigid fourfold hierarchical, endogamous and hereditary system categorising people in accordance to function, rituality and purity. This understanding was reproduced through numerous texts written by

⁴ The Burghers were Sri Lankans of Dutch ancestry.

⁵ A Tamil farmer or cultivator caste.

⁶ Subcaste or subdivision of the four *Varmas*, which division is based in occupation.

⁷ Many of the Western educated Ceylonese who returned to island around the time of independence came to represent the island’s powerful political elite. But after 1956, when after the passing of the ‘Sinhala Only’ bill in parliament, which largely reduced the Tamil population to second-class citizens, the early migrants’ intentions of one day returning to Ceylon largely withered.

Europeans, but has later been criticised for overemphasising the importance of *Varna* and the fluidity originally inhibited in the caste system in pre-colonial times (see e.g. B eteille 1996, Hocart 1950, Inden 1990, Subramanian 1999). The classification of people on the basis of race was also a rather recent concept and unfamiliar to the Ceylonese before the arrival of the colonial powers (Gunawardana 1990, Rajasingham-Senanayake 2002, Rogers 1990, Wilson 1988). They ignored (and failed to grasp) the ethno-linguistic mixing and cultural hybridity which had prevailed among the island’s diverse communities (Rajasingham-Senanayake 2002). The British also associated race with caste, and linked the colour associated with *Sudras* in Hinduism with the skin colour of the Dravidians, namely ‘black’ (Hocart 1950, Inden 1990). Dravidians were consecutively defined to be *Sudras*, the lowest of the four *varnas* (Subramanian 1999). These concepts of social classification were established and reproduced by the British and later also by the English-educated elite, and laid the foundation for the development of nationalist discourses. It is nevertheless important to bear in mind that this ordering of people according to caste and race had greater impact in India than in Ceylon. More or less the whole of the Sri Lankan population were considered to be *Sudras*, and while the Brahmins in India were left with great religious and secular power, the Ceylonese Brahmins which are very scarce in Sri Lanka (the majority being of Indian origin), were ranked decisively below the farming-caste (*jati*) of the Vellalas in a secular sense (Banks 1960, Dumont 1980). However, while India consisted of a conglomerate of ethnic groups, languages and religions, Ceylon only had two major ones where one – the Sinhalese – was clearly dominant. No conceived ‘group’ in India was as numerically superior as the Sinhalese was in Ceylon. India’s post-colonial visionary leaders saw the need of balancing the representation of its large diverse population within a federal structure to keep the country together. This was never done in Ceylon.

THE EMERGENCE OF NATIONALISM IN SRI LANKA

Sinhalese and Tamil consciousness and identity underwent radical changes in the nineteenth century. Attributes like language, race and religion were transformed into fundamental features of identification⁸. The basis for the development of nationalist ideologies was as

⁸ Religion was never the important issue for Tamil nationalists that it was for the Sinhalese, though the Tamil literate Arumuka Navalar (1822-79) started an “awakening” of Saivite Hinduism, which largely was a reaction against the Christian missionaries’ conversion of Hindus in the Christian colleges. A linguistic nationalism among Tamils erupted from the religious awakening, but soon broke from it. While the linguistic issue and the Tamil language later

stated above, laid in colonial times with the establishment of western ideas which categorised people in accordance to occupation, religion, caste and race. These ideas constrained the fluidity that previously had existed within the south Indian and Sri Lankan societies, and gave room for the development of nationalist discourses which confined people within a defined ethnicity or nationality. This 'new' way of thinking about history in Ceylon included first, the demand of a great historical past for Ceylon (Hellmann-Rajanayagam 1990, Rogers 1990), and second, an emphasis on ethnic distinction between the different peoples of Ceylon and what was considered their 'historical antagonistic relationship' (Rajasingham-Senanayake 2002, Rogers 1990).

NEGOTIATING EMERGING NATIONALIST MYTHOLOGIES

The social composition in Ceylon in the decades ahead of independence was represented by a major division between people, but this differentiation was not represented by ethnicity, but by class. It was the large western-educated English speaking multiethnic elite (consisting of both Tamils and Sinhalese), mainly Christian and from high caste and wealthy families who dominated the colonial administration and who worked for a peaceful transition to independence (Stokke 1997). However, the struggle for influence and political power before independence was largely between conservative modernists and social revolutionists within this elite group. In later stages, exclusionist nationalist discourses, and politicised legends were used as instruments primarily by the conservative majority to gain a wider political legitimacy for their political projects from the lower Sinhalese classes and castes (Stokke 1997). This feature coincides with Ernest Gellner's (1983) argument when he describes nationalism as a political principle which requires a correspondence between the political and the national within ethnic boundaries in order to obtain a certain political legitimacy.

The Sinhala Buddhism revivalism in the mid-nineteenth century was related to an anti-Christian movement instigated by the Buddhist clergy. This movement contributed to shaping Sinhalese national consciousness and identity, and had both nationalist overtones, as well as political and economic dimensions (Tambiah 1992). It served the interest of the rising Sinhalese Buddhist middle class and business elite (who were experiencing an expanding local capitalism), and celebrated the past glories of Sinhalese Buddhist civilisation. Racial ideas

became one of the central issues in Sri Lankan Tamil nationalism, the religious movement faded away and disappeared (Wilson 2000).

were adopted from the European colonialists, whereupon their “Aryan” ancestry and language was emphasised. The consequent emergence of racialist writings in Ceylon altered the understanding of “Sinhalese Buddhism”, where in effect, an autochthon bond to Ceylon was infused in its meaning. This resulted in an exclusionist nationalist rhapsody where anti-Tamil discourses were reproduced. Perhaps the strongest example of this was the reinterpretations of the *Mahavamsa*. The glories of ancient Sinhalese Buddhist civilisation described in this chronicle, was actively used to advocate the island as homeland of authentic Buddhism (Kapferer 1988, Rajasingham-Senanayake 2002, Stokke 1997, Tambiah 1986, 1992).

The Sri Lankan Tamil nationalism however, did largely emerge as a consequence of their perception of being marginalised by the Sinhalese elite’s growing exclusionist nationalism. Though some literature (e.g. De Silva 1998, Gunaratna 1993, Hellmann-Rajanayagam 1990) co-joins the Sri Lankan Tamil nationalist movement with Tamil Nadu’s Dravidian movement, which I will approach later in this chapter, Krishna (1998) argues that these political movements not only developed separately, but also evolved in opposite directions.

POLITICISING LEGENDS AND THE PAST IN A NATIONALIST PROJECT

In spite of the lack of emphasis on ethno-political attributes among Sinhalese and Tamils in pre-colonial and early colonial times, these politicised and racially infused reinterpretations of historical texts and legends were means in which both the Sinhalese and the Tamils produced such “cultural golden ages”, and which eventually were important parts of a polarisation of the two peoples. The Sinhalese had their heroic past and historical heroes from the *Mahavamsa*⁹. The Sri Lankan Tamils on their hand had own texts¹⁰ and the Jaffna Kingdom in

⁹ Two legends from the *Mahavamsa* were and still are severely used in contemporary Sinhala nationalism – and construed as historical realities to legitimise their political claims (Kapferer 1988). In both legends, the Sinhalese have been interpreted as being the ‘true’ Ceylonese, while Hindu Tamils were interpreted as ‘alien’ posteriors on the island. The first legend is also seen as the myth of origin of the Sinhalese. Prince Vijaya is said to have come to the island with 700 men at the death-day of Lord Buddha in 483 B.C after having been expelled from India by his father due to Vijaya’s unruly behaviour. He conquers the chthonian *Yakkas* who inhabit the island, and after having wedded an Indian princess and married his men to women brought from India, he establishes the royal line of Sinhalese kings. According to *Mahavamsa*’s version of the myth (a slightly different version of the story of Vijaya is to be found in an older Sri Lankan chronicle, the *Dipavamsa*), Vijaya’s grandfather Sihabahu was a lion. In spite of the emphasis on the *Mahavamsa* by the Sinhalese nationalists, the word ‘Sinhala’ only occurs twice in the chronicle. The concept of Sinhalese primacy on the island is established through this myth. The second myth concerns Dutugemunu, the great hero of the *Mahavamsa*. In a final combat, he kills the Hindu Indian king Elara from the Chola country (with its centre in today’s Tanjore). The Chola kingdom conducted several conquests to Ceylon, and also expanded its polity to the island. With Dutugemunu’s victory, the foreign Hindu overlord was expelled from Ceylon. Interpretations of this myth present the Tamils as agents of foreign power, and as descendants of the Indian

northern Sri Lanka, which remains central in Tamil nationalist rhetoric when justifying claims for a separate Tamil country¹¹. But differently from the Sinhalese, the Tamils had the possibility of choosing between two histories (Hellmann-Rajanayagam 1990). On one side they could stress their belonging or primacy to the island and Jaffna. On the other, they could associate themselves with the Indian subcontinent and a larger sphere of Tamil culture. Though the Ceylon Tamils saw themselves as being part of a wider cultural region represented by the Indian subcontinent, the awareness of being a Tamil was nevertheless concentrated around one political unit, namely Ceylon – and not India (Krishna 1998). While the Tamils included the Sinhalese in their historical interpretations (as they tried to convince the Sinhalese of their Dravidian ancestry), the Sinhalese nationalist rhetoric adopted an exclusionist nationalism seeing the Tamils as agents of foreign power and as non-Aryans. However, in the 1930s, an argument gained weight among the Tamils, claiming that it was irrelevant whether the Sinhalese were Dravidians or not, but if they were, they were of an inferior sort. The important issue was the claim that the Tamils had been the first people in Ceylon, and that their culture and civilisation was higher and more sophisticated than the Sinhalese Buddhist (Hellmann-Rajanayagam 1990). The idea of primacy was now also established among the Tamils as it already was among the Sinhalese – and with this – the emphasis came to be on differences rather than on similarities. As the conceptions on differences got ingrained, the awareness of being a minority became evident among the Ceylon Tamils (Hellmann-Rajanayagam 1990, Wilson 2000).

QUESTIONING LEGENDS AND THE PAST IN NATIONALIST DISCOURSES

In the nationalist interpretations of the past and of chronicles, people are seen as having primordial roots in the land they inhabit. Such an approach, where the nation is perceived as

Hindu Chola invaders, though the Tamils had lived on the island long before the Cholas ever arrived (De Silva 1981). This interpretation is deducting the Tamils their right for being on the island.

¹⁰ Like the Sinhalese, the Tamils had their chronicles. The *Yalppana Vaipava Malai* (YVM) or “The Garland of Jaffna Events”, written by Mayilvakana Pulavar was completed in the early eighteenth century and was based on a conglomerate of myths, oral traditions and palm leaf manuscripts of uncertain date. As some of the nationalist reinterpretations of the *Mahavamsa* stressed Tamils as aliens, the YVM emphasised the Sinhalese as the adversaries of the Tamils. The YVM maintains that the Tamils had Sri Lanka as a homeland of their own. There is also a controversial retelling of the Vijaya myth in the YVM, where Vijaya was described as a Tamil Hindu Prince who built some of the oldest Saivite temples on the island. In 1926, Rasanayagam’s *Ancient Jaffna* was compiled and created large-scale protests among Sinhalese intellectuals and racial conscious nationalists. The book claimed a Dravidian ancestry for both Tamils and Sinhalese, and maintained that the history of Ceylon was in fact Tamil-Hindu history. The Sinhalese saw this as an attempt to deprive them of their Sinhala-Buddhist roots.

¹¹ The Jaffna Kingdom persisted for approximately 300 years, when it succumbed to the Portuguese invaders in the 1620s.

ancient and where features such as language, race, ethnicity and/or territory are seen as rooted in ‘pre-modern’ differences, and perceived as given and natural (Geertz 1967) is problematic in several ways. First of all, it tends to ignore internal stratification and fractioning within a nationality, as well as variation and change within the nationalist discourses themselves. Secondly, while the nation is an entity with which one identifies oneself and which calls upon strong loyalties, it is also an artificial creation – or to quote Benedict Anderson, an “imagined community” (Anderson 1996:19). Members of a nation may only know a few other members of the same nation, but they nevertheless identify themselves (or ‘imagine’ themselves) as being part the same community. Gellner (1983) puts it like this:

“Nationalism – the principle of homogenous cultural units as the foundation of political life, and the obligatory cultural unity of rules and ruled – is indeed inscribed neither in the nature of things, nor in the hearts of men, nor in the pre-conditions of social life in general, and the contention that it *is* so inscribed is a falsehood which nationalist doctrine has succeeded in presenting as self-evident” (Gellner 1983:125, italics retained).

When the Sri Lankan state is regarded as equivalent to the Sinhalese Buddhist nation, it promotes the argument that the state and the nation are destined for each other, and that one is incomplete without the other. This is problematic as state and nation in a historical perspective, has to be independently constituted before they can be intended for each other. Another questionable aspect regarding the politicised understandings of the past and of these chronicles and legends is the way they have been interpreted in relation to actual historical factors and influences. One recurrent tendency is for instance to emphasise the conflicts between the ancient Sinhalese kingdoms and the south Indian invaders to be based on ethnic or racial oppositions. However, classification of people in Sri Lanka in racial and ethnic terms is the result of the above-mentioned adopted colonial perspectives on history and pasts and therefore moulded by contemporary ideology (Gunawardana 1990, Rajasingham-Senanayake 2002, Rogers 1990, Wilson 1988). Colonial censuses also reveal the absence of any ethnic polarisation between Tamils and Sinhalese in the early part of the British Raj (Rajasingham-Senanayake 2002)¹².

¹² The earliest historical inscriptions on Sri Lanka, the *Brahmi* inscriptions, reflect an initial stage of group consciousness, related to lineage, *varna*, socio-political position, tribal affiliation and a beginning religious identity, but concepts referring to race is absent. The word ‘race’ is of European origin stemming from around the sixteenth century, and according to Gunawardana (1990) and Rajasingham-Senanayake (2002), no satisfactory term with

Bruce Kapferer (1988) is also critical to the way legends and myths often are presented as historical sources. He argues that one must see these myths within their own context and is disapproving of a personal rational view on the myths, where one's own logic constitutes the basis for a valuation of the myths' validity. Kapferer argues that one cannot use this personal rationality to evaluate whether some myths are true, while others are not. One must see all myths in light of its origin, within the setting and logic wherein these myths are created. One cannot argue that some aspects of the myths are truer than others based on ones own conceptions of reality or on the background of ones own rationality. In other words, one cannot level their truthfulness on background of a personal valuation system.

1948: INDEPENDENCE PREVAILS

At the same time as the growing Sinhalese and Tamil conceived awareness and conception of being different, Ceylon got its independence in 1948. The alienation of the Tamils commenced shortly after, and only increased as the years passed. These years were represented by a series of 'milestones': the disenfranchisement of the Upcountry Tamils, the 'Sinhala Only' act, the abrogations of the Bandaranaike-Chelvanayagam, and Chelvanayagam-Senanayake pacts by the Ceylonese governments, the rewritings of the constitutions in 1972 and 1977 increasing central power and the standardisation policies for entry into universities and for attaining government jobs. This was topped by successive riots directed against Tamils. In the 1970s after numerous unsuccessful attempts by Tamil politicians to restore their status in the Sri Lankan society, secessionist demands arose. As this had little results, a military insurgence developed which eventually lead the country into an armed conflict.

INDEPENDENCE AND THE DISFRANCHISEMENT OF THE UPCOUNTRY TAMILS

Sri Lanka got its independence in 1948 – one year after India, but already then there was a growing sentiment among the Tamils that they were being marginalised by the Sinhalese majority. A few years before, during the constitution negotiations, the Tamils advocated a communal formula based on a 50-50 representation in the Parliament between the Sinhalese

equivalent meaning is found in Sinhala or in Tamil. Furthermore, it is only in the fourth or fifth century A.D. that the first mentioning of the term 'Sinhala' occurs, but Gunawardana argues that this probably is more a designation of a ruling class than of ethnicity or race. He also emphasises that the divergent nature of the early settlements was an unfavourable factor in the development of a strong group identity. This gives evidence of the wars in ancient Sri Lanka being dynastic and purely political in nature, rather than ethnic or with racial overtones.

majority and the minorities¹³. The purpose was to avoid one community from dominating the others (Wilson 2000). However, the proposition was rejected and instead, a system based on territorial and demographic representation benefiting the dominant Sinhalese prevailed, and also became the electoral principle. The first election in 1947 was won by D.S. Senanayake and the newly established *United National Party* (UNP). Senanayake offered some of the leading Tamils seats in the government and with their support enacted the 'Ceylon Citizenship Act of 1948' and the 'Indian and Pakistani residents (Citizenship) Act of 1949'. These laws disfranchised the majority of the Upcountry Tamils of Indian origin who constituted approximately 5% of the Ceylonese population. They were deprived of their citizenship and voting rights and were rendered stateless. The seven representatives of the Upcountry Tamils were relieved of their seats by the next election.

THE LANGUAGE ISSUE AND 'SINHALA ONLY'

A few years after independence, the UNP government initiated what the Tamils interpreted as a "colonisation of the Tamil areas" by Sinhalese peasants. Though the UNP government claimed that this was for the purpose of water- and agricultural development, the Tamils interpreted this as a deliberate attempt to occupy and claim the Tamils' traditional homeland (Tambiah 1986, Wilson 2000). In 1951, S.W.R.D. Bandaranaike broke out of UNP and established the *Sri Lankan Freedom Party* (SLFP). He won the election in 1956 on his 'Sinhala Only'-policy, making Sinhala the only official language in Ceylon, replacing English, but also reducing Tamil to a second-class language. Tambiah (1986) asserts that language has been of crucial importance in Sri Lanka after independence due to its relevance for education, medium of instruction and employment. Education was regarded as a crucial door-opener for many Tamils, as they lived in barren areas away from the commercial and plantation development areas in the southwest and central highlands. A non-violent sit-down demonstration (*satyagraha*¹⁴) against the 'Sinhala Only'-bill, headed by the Tamil *Federal Party* (FP) and its leader S.J.V. Chelvanayagam, resulted in the first anti-Tamil riots by Sinhalese mobs. The following year FP, who at the time worked for an "autonomous Tamil legislative state within a Federal Union of Ceylon", reached an agreement with SLFP concerning the recognition of Tamil as a 'Language of Ceylon' and the establishment of elected regional

¹³ 50% Sinhalese and 50% divided between the Ceylon Tamils, the Upcountry Tamils, the Muslims, the Burghers and other minorities.

¹⁴ *Satyagraha* is a Hindu concept of passive resistance against injustice based on non-violence (*Ahimsa*) which also was adopted by Mahatma Gandhi.

councils to correct national administrative over-centralisation (Tambiah 1986:73). The implementation of the so-called 'Bandaranaike-Chelvanayagam-pact' was, however, clogged after large Sinhalese protests, a massive Buddhist sit-down demonstration and condemnations by the UNP. The Tamil protests that followed in 1958 after the abrogation of the agreement were succeeded by new Sinhalese anti-Tamil riots.

WIDENING THE GAP

In 1959, S.W.R.D. Bandaranaike was assassinated by a Buddhist monk, and was succeeded by his widow, Sirimavo Bandaranaike. In 1964, Mrs. Bandaranaike and Indian Prime Minister Lal Bahadur Shastri signed an accord which randomly determined the future of the majority of the stateless Upcountry Tamils. 525,000 were to be 'repatriated' to India while 300,000 were to be approved Ceylonese citizenship; nevertheless 150,000 people were still kept in abeyance. None of the political representatives of the Upcountry Tamils from the *Ceylon Workers Congress* (CWC) were consulted in this process, and their reluctance to this agreement was made evident as they worked to delay the repatriation while encouraging the process of re-enfranchisement. Many Upcountry Tamils were also unwilling to leave Ceylon. In spite of a similar agreement in 1974, and concessions given by the President in 1987 after pressure from the CWC, the fate of the Upcountry Tamils still remains unresolved. A situation similar to the fate of the 'Bandaranaike-Chelvanayagam pact' occurred in 1965, as D.S. Senanayake abandoned his agreement with Chelvanayagam, which were to give some concessions to the Tamils. In 1970, the FP stated a manifesto proclaiming their federal position, and accentuated the need to remain firm on their call for a one-island entity. However, beneath the surface, secessionist tendencies started erupting, looking in the direction of Tamil Nadu, but the FP denounced any willingness to establish ties with the Indian Tamil party *Dravidar Munnetra Kazhagam* (DMK)¹⁵. The catalysts that triggered a full-fledged Tamil nationalism was however the system of standardisation of marks for admission to the Universities where higher qualification marks were required from Tamil students than from Sinhalese (De Silva 1981, Tambiah 1986, Wilson 1988, 2000). Bandaranaike also established Buddhism as the official state religion, made the country a republic and changed the name Ceylon to the more 'Sinhalese' Sri Lanka.

¹⁵ 'Federation for the Progress of Dravidians'. DMK was the leading Tamil regional party in India at the time. In 1967, the DMK officially withdrew its secessionist claims.

A consequence of the increasing discrimination of Tamils, particularly in the educational sector was an increasing migration to the West. Differently from the earlier wave of migrants, who were multi-ethnic and who mainly consisted of high-caste and high-class people Tamils from a wider spectre of caste and class in the Sri Lankan Tamil society now migrated. They were generally poorer than the former, and furthermore, did not identify themselves with other Sri Lankans with similar or analogous class origin. Ethnic identity had become important for them. Few spoke Sinhala as they generally had been educated in Tamil medium, and many saw Sinhalese as strangers, and sometimes even as enemies due to the increasing public discrimination of Tamils on the island. In spite of caste and class differences between the two groups, education and similarity in professional ambition reduced potential problematic divergences.

TAMIL MILITANCY

In 1972, a Tamil separatist group who called themselves *Tamil New Tigers* (TNT) was founded by a group of youth in northern Jaffna – they had their first ‘operation’ in 1975 killing the Tamil ‘government-loyal’ major of Jaffna. And in 1976, breakaway members of the FP with the policy to establish a separate Tamil state, Tamil Eelam in the north and east of the island, formed the *Tamil United Liberation Front* (TULF). TULF won an overwhelming victory in the Tamil areas in the 1977 elections, and the following year, the UNP won a landslide victory in the national elections, marginalising SLFP and making TULF the main opposition party. Prime Minister J.R. Jayawardene introduced employment patterns similar to the standardisation system, and in 1977 changed the constitution and introduced a Presidential system which granted the President almost supreme power.

The military involvement to ‘curb’ the increasing trouble and ‘anti-government’ activity and attacks by Tamil militias in Jaffna – primarily by the TNT who by 1976 had changed their name to the *Liberation Tigers of Tamil Eelam* (LTTE) – and the introduction of the *Prevention of Terrorism Act* (PTA) in 1979 – which placed severe constraint on civil liberties¹⁶, reflected the President’s increasing authoritarianism (Samarasinghe and Samarasinghe 1998, Tambiah 1986). Also, the increasing frequency of army violence against Tamil civilians in Jaffna, anti-Tamil riots – in 1977, 1979, and in 1981 and the authorities’ inaction to these, widened the

¹⁶ PTA permitted the government (the army and the police) to hold prisoners incommunicado for up to eighteen months without trial.

gap between the Sinhalese and the Tamils even further, and in 1983 the situation got out of control.

JULY 1983

In July 1983, 13 army soldiers were killed in Tinnively in Northern Sri Lanka in an LTTE ambush. This resulted in devastating anti-Tamil riots all over Sri Lanka with its epicentre in Colombo. The government admitted 350 Tamils killed, while Tamil sources estimated 2,000. The riots resulted in between 80,000 and 100,000 refugees in Colombo alone, 18,000 households were affected, and reconstruction was estimated at £55 million (Tambiah 1986). Approximately 30,000 Tamils fled to India following the riots (Amal Raj 1997, Bastiampillai 1996). It is also assumed that the riots were organised from people in high political positions, and that the attack in Tinnively only was the incident they had waited for to spark the whole thing off. The mobs were provided with electoral lists so they could easily locate Tamil houses and shops to attack, burn and loot. In the Welikade prison 53 Tamil political prisoners were killed by Sinhalese inmates, though they were kept separately in maximum security. The government approved the Sixth Amendment to the constitution shortly after the riots, where the advocacy for a separate state within Sri Lanka was made illegal and TULF was banned from parliament. After these violent July days, the island erupted in full-scale war. The period up to 1987 has been called the First Eelam War.

THIMPU

After sporadic attempts on negotiations between the Sri Lankan militants, who now counted five large organisations – LTTE, EROS, TELO, EPRLF and PLOTE – and the Sri Lankan Government, India's Prime Minister Rajiv Gandhi took the initiative to organise talks in the Bhutanese capital Thimpu. India had long been involved in the Sri Lankan question, politically but also militarily, by arming and training the militants for own political and strategic purposes through their foreign intelligence agency, the *Research and Analysis Wing* – RAW. The Tamil groups presented four demands concerning the recognition of them as a nationality, the guarantee of their territorial integrity, self-determination for the Tamil nation and the recognition of the Tamils' fundamental rights¹⁷. This was rejected by the government

¹⁷ 1. the Tamils to be recognised as a distinct nationality;
2. the recognition and guarantee of the territorial integrity of the traditional homelands of the Ceylon Tamils;

delegation. The government on their hand produced five pre-conditions for a settlement which the Tamil delegates in turn did not approve: the Ceylonese constitution, the unitary state structure, the national flag, the special status accorded to Buddhism and the democratic system (Wilson 1988:186-187). When 200 Tamil civilians were massacred in Vavuniya by the Sri Lankan Army (SLA) in August 1985, the Tamil delegates left Thimpu in protest. S.D.Muni (1993) however maintains that there was no real willingness among neither of the two sides to make Thimpu a success, and that both in fact only wanted to show that the other part was not sincere.

THE IPKF AND THE INDO-SRI LANKAN ACCORD

In 1987, India intervened into the Sri Lankan affairs and pressured the government to accept India's involvement to find a solution on the ethnic crisis. The Indo-Sri Lankan accord was signed and included the establishment of the Indian Peace Keeping Forces (IPKF) to monitor the process. The Accord opened up for the establishment of an elected Provincial Council comprising the Northern and Eastern Province. The two provinces were to be united under one administrative unit as a provisional solution. An eventual prolongation of this unit was to be decided within 1988 by a referendum.

The accord was surrounded by much secrecy and information was withheld till the last moment (Gunaratna 1993, Narayan Swamy 1994). RAW were still involved in arming the militants at the time of the signing, many Sri Lankan ministers were not aware of the agreement until it was endorsed, and Prabhakaran – the leader of the Tamil Tigers was held incommunicado in New Delhi as Gandhi and Jayawardene signed the accord, though he is supposed to have given his verbal consent to Rajiv Gandhi (Gunaratna 1993). Once it was known, major protests erupted from the opposition, and Rajiv Gandhi was attempted assassinated by a ceremonial guard of honour while in Colombo. It also soon became clear that the Indian intelligence had done a poor job and that the complexity and difficulty in dealing with this issue had been underestimated by the Indians.

3. the right of self-determination of the Tamil nation; and
4. recognition of citizenship and fundamental rights of all Tamils who regard Ceylon as their homeland.
(Wilson 1988:186)

Problems erupted as the LTTE failed to hand in weapons according to the agreement and also attacked its rival militants after they opened offices in regions where the Tigers had banned them. LTTE simultaneously increased its criticism of the Accord, and accused the Indian forces for cooperating with the Sri Lankan government in their colonisation of the Tamil areas and for supporting their militant rivals (Narayan Swamy 1994). As a protest, LTTE's political leader for Jaffna, Thileepan initiated a fast to which he succumbed 11 days later. The agreement got its ultimate blow after the IPKF informed the Sri Lankan government about an LTTE ship with weapons entering Sri Lankan waters. Sri Lanka's Minister for National Security insisted that the captives should be taken to the capital, but before this could be done 12 of the 17 captives died in a mass-suicide after having consumed cyanide capsules which had been smuggled into the prison¹⁸. The Tigers initiated an offensive on the Sri Lankan Army and the IPKF following this incident. A full scale war erupted between LTTE and IPKF. The Indians had a hard time to distinguish Tiger cadres from civilians and started committing acts that before only had been prerogative of the SLA. Thousands of civilians were being displaced following an Indian offensive on Jaffna, and Narayan Swamy (1994) asserts that half of all the casualties of IPKF bullets were civilians, including women and children. Due to the IPKF-fiasco, Jayawardene decided not to run for re-election as President in 1989. Ranasinghe Premadasa (UNP) was elected Sri Lanka's President in 1989 and initiated negotiations with the Tigers which resulted in formal cessation of hostilities between the two parties. Colombo also delivered weapons to the LTTE to support their fight against the Indian forces (Narayan Swamy 1994). In December 1989 when the local Indian criticism of IPKF was at its peak, Rajiv Gandhi's Congress (I) Party lost the Indian Parliament elections. IPKF's *raison d'être* on the island was brought to an end and had to withdraw.

EELAM WARS AND PEACE PROCESSES

The peace between the Premadasa government and the LTTE lasted only four months after the last IPKF soldier had left the island. In the period up to 1994, when Bandaranaike's daughter Chandrika Kumaratunga won the Presidential election with the promise to make peace, two vital features surfaced. First, the worsening relationship between the LTTE and the Muslims, and second the fortification of the Tigers' military power and the further

¹⁸ All LTTE-cadres are equipped with a cyanide capsule which they are to consume if they get caught by their enemies. These captives were deprived from taking their capsules by the SLA when they were caught.

marginalisation of LTTE's militant opponents. The strengthening of LTTE's military power is partly related to a changing migration pattern among the Sri Lankan refugees. Until this time, most Sri Lankan refugees had fled to India, but with the banning of the LTTE and India's restrictive and hostile policy towards the refugees, many Sri Lankans started migrating to Western Europe and Canada instead. This influenced the LTTE economy, as the Tigers established themselves in many countries from which they built up networks which contributed to the war economy. Such contributions were large from the worldwide civil Tamil expatriate communities. In a few years, LTTE grew from a rather small but determined, shrewd and well-disciplined guerrilla group into a powerful army with substantial gun power and with an own navy (The Sea Tigers) and suicide squad (The Black Tigers).

In the first weeks of the Eelam War II, as the period from 1990-94 has been called, the Tamil Tigers managed to take control over the majority of the Jaffna Peninsula with high civil casualties among all ethnic groups. In this process, the LTTE drove out the Sinhalese and Muslim civilian population from the areas they controlled. This also marked the beginning of the second large refugee flow into India from the island. Internal fighting between the Tigers' militant rival groups, the emergence of LTTE as the undisputed supreme Tamil militant group, as well as LTTE's ruthless propensity for power led the other militant groups to renounce separation, and instead go for a federal settlement (Ryntveit 1996). Many groups also started to cooperate with the government and the SLA in order to fight the Tigers.

In 1994, LTTE and the SLFP-led People's Alliance (PA) initiated peace talks, but already in April 1995, they collapsed. This triggered off the Eelam War III. The SLA instigated a military offensive and seized Jaffna. Some 400,000 Tamils were displaced and large numbers fled to India. The Tamil Tigers intensified its guerrilla operations in the East and its suicide attacks, killing several influential politicians and moderate Tamils¹⁹. They also struck Colombo's financial centre in 1996 in a devastating suicide attack. However, a crucial difference between the Kumaratunga administration and its predecessors was that it more clearly sought to distinguish the Tamil civil population from the LTTE and that it opened up

¹⁹ Up till 2001, 70 politicians have been killed by the LTTE. Among them were A. Amirthalingam – the leader of TULF in 1989, Deputy Minister of Defence and General Secretary of the UNP Ranjan Wijeratne in 1991, UNP-opposition leader and former Defence Minister Lalith Athulathmudali in 1992, President Premadasa in 1993, Gamini Dissanayake opposition leader and President Candidate for the UNP in 1994, TULF MP and peace activist Neelan Tiruchelvam in 1999. An unsuccessful attempt on Chandrika Kumaratunga's life, also that in 1999, cost her one eye.

for a federal solution, but only to have its alleged federal intentions mistrusted by the Tigers. LTTE on their hand refused to negotiate as long as the government did not lift certain embargos on food and vital goods affecting the civil population, and as long as the Sri Lankan forces had control over Jaffna. In the following years, several substantial battles were fought; resulting in heavy casualties on both sides, and little progress was done to find a peaceful solution. In May 2000, Norway instigated a programme of quiet diplomacy and started acting as a facilitator between the two parties. LTTE declared a unilateral ceasefire on 24th December 2000, but this was not followed up by the Kumaratunga's People's Alliance (PA) coalition. The ceasefire was abrogated in April 2001, only to be reinitiated eight months later after a UNP-led coalition won the parliament election. This time the ceasefire was reciprocated, and the parties are currently working to find a peaceful solution to the decade's long conflict which so far has claimed more than 60,000 lives.

TAMIL NATIONALISM AND 'DRAVIDIANISM' IN TAMIL NADU

O mother! When I ask the Tamilian to name his country, he sheepishly
says that is India
O mother! How will this child ever reform if he confuses the evergreen
Tamil land with India?
O mother! Will the one who does not realise who his mother is,
And think that the evil one who destroys his own mother's country is his
mother,
Will that person ever improve?
O mother! How can he lie down in his mother's lap and drink the
mother's milk that is Tamil and not know who his mother is?
Does not the Tamilian realise that that the Tamil language is his mother
tongue, and that the Tamil country is his motherland?²⁰

The 'Dravidian nationalism' in Tamil Nadu differed from both the Sinhala Buddhist revivalism, and from the Tamil nationalism in Sri Lanka. While attacks were stirred against out-groups based on ethnic reasoning in Sri Lanka, nationalism in Tamil Nadu never encouraged violence. Differently from the Sri Lankan Tamil nationalism where nationalism and radicalism increased as the years went by, the exclusionist aspects of the Dravidian nationalist movement decreased. In Sri Lanka, the Tamils' feeling of being alienated eventually radicalised them to the point where they went to fight for secession by means of military insurgence. In Tamil Nadu on the other hand, early secessionist demands were abandoned in the 1960s and their emphasis was shifted from policing ethnic boundaries to a

²⁰ Bharatidasan, quoted in Ramaswamy (1993:705). Bharatidasan (1891-1964) was also known as "The revolutionary poet", he participated in the Dravidian movement in endeavouring "the cultural renaissance" in Tamil Nadu.

populist revaluation of plebeian culture and a focus on social reform through the creation of power and privileges for emergent groups (Subramanian 1999).

'PERIYAR' AND THE NON-BRAHMIN MOVEMENT

The Dravidian revivalist movement developed in today's Tamil Nadu²¹ in the nineteenth century. This movement emphasised Tamil or Dravidian interests and 'values' vis-à-vis the Central State and so-called 'Brahmin values'. As in the Sri Lankan nationalist movements, the Indian Tamil revivalism accentuated notions of language, literature and "authentic culture". As the first 'non-Brahmin' organisations, the Dravidian Association was established in 1912, and the Justice Party was formed in 1916. The 'Non-Brahmin movement', as the movement also came to be known as, was fronted by the self-proclaimed atheist 'Periyar' E.V.Ramaswami Naicker (hereafter only Periyar)²². Periyar highly disapproved of Brahminical ideas of caste status, which he claimed were imposed on the autochthon Dravidian Tamils, and which had reduced them to an inferior people in their own land. In this rhetoric, Brahmins were distinguished from the plebeian Tamils as Aryan invaders from the north (Dickey 1993, Price 1996). There was a notable imbalance in the public sphere at the time, where the English educated Brahmins were a privileged group dominating public life and occupying the majority of the white-collar jobs and the leading positions in the colonial administration (Béteille 1997, Dickey 1993, Krishna 1998, Price 1996, Subramanian 1999). The movement aimed at reclaiming "lost" power and privileges from the Brahmins. Periyar contrasted Brahminical ideas to what he postulated as the 'original' heritage of the Tamil Country, represented through virtuous, secular and egalitarian concepts (Price 1996). In 1925, Periyar founded the Dravidian 'Self-Respect league', an organisation consisting of Dravidians from all parts of southern India. 'Self-Respect'²³ was defined as a refusal to obey the dictates of caste etiquettes and behaviour, and a personal capacity to develop and rule oneself without reference to people's rank. In 1944, Periyar established the *Dravida Kazhagam* (DK)²⁴ – a Dravidian association, which contrary to the 'Self-Respect league' mainly consisted of Tamils.

²¹ Formerly the 'Madras Presidency'.

²² E.V.Ramaswami Naicker (1879-1973) adopted the name 'Periyar', which literally means 'The Elder' or 'The Great One'.

²³ '*Sūya-mariyātai*' in Tamil, which according to Price (1996:363) better can be translated as 'self-honour'.

²⁴ 'Dravidian Federation'.

DMK AND THE RISE OF DRAVIDIAN PARTY POLITICS IN TAMIL NADU

In 1949, the younger leadership of the DK broke out and founded the political association *Dravidar Munnetra Kazhagam* (DMK) aiming at a wider audience than their predecessor, at the rural society for instance. The DMK-leadership propagated a new cosmology with visions of a new social and political order based on reinterpretations of ancient Tamil past. They emphasised ‘equality’ between castes (not in the sense of eliminating caste differences, but that all castes should be equal) and Tamil concepts of honour (drawn partly from Periyar’s ideas and partly from what was presented as ‘ancient’ pre-colonial monarchical cosmology). DMK tied together symbols of chastity, devotion to the Tamil language and the idea of freeing the Tamils from north Indian political domination in their political rhetoric. In 1957, DMK started contesting the state elections and became a serious competitor to the ruling pan-Indian Congress (I). They first contested as secessionists, but demands for separation were later abandoned²⁵. DMK won the state elections in 1967 and again in 1971. But in 1972 as a consequence of the death of Chief Minister C.N. Annadurai in 1969, a faction led by the immensely popular silver screen star M.G. Ramachandran (popularly called ‘MGR’) split from DMK²⁶. Internal conflict between the new Chief Minister M. Karunanidhi and MGR led the latter to form the *Anna Dravidar Munnetra Kazhagam* ADMK (later to be renamed AIADMK²⁷). The political differences between the two Dravidian parties were initially virtually non-existent as Tamil politics were largely centred around persons and ‘personal appeal’ rather than on political issues (MGR had an almost god-like status among his movie fans) (Dickey 1993, Krishna 1998). Furthermore, the crystallising of two Dravidian parties completely marginalised pan-Indian political parties in the state. And the struggle for political power in Tamil Nadu has ever since been a contest between DMK and AIADMK, each with their allies and coalition partners. In spite of this, close ties between the Dravidian parties and the Central Government existed from the late 1960s up till today.

²⁵ According to Krishna (1998), DMK’s decision to give up secession was made as early as November 1960, though some time was given before a public declaration of it was made: “...to prepare the party for dropping the Dravida Nadu demand” (Barnett in Krishna 1998:328). In 1967, the decision was made public.

²⁶ Film was a crucial political medium in which the DMK propagated their political symbols and discourses, and the majority of Tamil Nadu’s politicians had been involved in Tamil film industry.

²⁷ *All-India Anna Dravidar Munnetra Kazhagam* (‘Anna’s all Indian Federation for the progress of Dravidians’).

NATIONAL INDIAN POLICY TOWARDS THE SRI LANKAN ISSUE

The deteriorating situation in Sri Lanka affected India on the national level as well as on state level in Tamil Nadu. The Central Government of India had to take into account the increasing support of the Dravidian parties for the Tamil militants on Sri Lanka. These parties were significant political coalition partners for various central governments. But more important, India had its own high political agenda which largely shaped the emerging Sri Lankan crisis. However, India's high political scheming and conniving would eventually turn back on themselves.

1971, RAW AND INDIA'S ARMING OF THE SRI LANKAN MILITANTS

The Indian Dravidian parties' support of the Tamil cause in Sri Lanka was initiated in the early 1980s and was largely influenced by the gradual change of India's national politics. Krishna (1998) argues that the 'success' of the Indo-Pakistan war in 1971, which eventually led to the formation of Bangladesh, was crucial in reshaping India's role in the South Asian subcontinent in the years that followed. India adopted a model of political conduction which involved extensive use of intelligence and diplomatic pressure in order to destabilise regimes perceived as inimical to India's geo-political interests. This was also the policy adopted towards Sri Lanka after Indira Gandhi's colleague Sirimavo Bandaranaike lost the Sri Lankan national elections in 1977. Indira Gandhi's attempt to bring Sri Lanka and its conservative pro-USA Prime Minister J.R. Jayawardene "in line", included the involvement of the Indian Foreign Intelligence – RAW. In the early 1980s, RAW was responsible for arming and building up the Sri Lankan Tamil militant groups²⁸. Though this activity went on for several years on Indian soil, it was continuously denied by the Central Government in New Delhi. India's direct intervention in East Pakistan in 1971 made the Sri Lankan militants, and also the public opinion in India and Sri Lanka to believe that India's intention was to "do a Bangladesh"²⁹ in Sri Lanka (Gunaratna 1993, Krishna 1998, Narayan Swamy 1994). This encouraged the militants further towards their ultimate goal of Eelam.

²⁸ India had originally chosen a policy of non-alignment, but following China's invasion of India in 1962, and China's links with USA and India's 'main foe' Pakistan, India under Indira Gandhi chose an alliance with the Soviet Union. When Sri Lanka's Prime Minister J.R. Jayawardene (also nicknamed 'Yankee Dick' for his close ties and appreciation of the U.S.) showed a clear pro-western policy, it was interpreted as a provocation and threat to India's role as a regional superpower.

²⁹ That is, to support the establishment of a separate state.

As the crisis in Sri Lanka worsened, the Indian Government gave the Sri Lankan Tamils a certain amount of support in response to the growing pro-Sri Lankan Tamil nationalistic feelings among the Indian Tamils. Though the secessionist threats of the Dravidian parties in India have been emphasised by many (Gunaratna 1993, Muni 1993, Narayan Swamy 1994) the actual threat posed by these may be questioned. Differently from Sri Lanka, the Indian Central Government had provided adequate political space wherein Tamil identity and regional autonomy could be practiced and protected (Suryanarayan and Sudarsen 2000). The Dravidian parties were loyal to the Central Government ever since DMK officially abandoned its secessionist demands in 1967. The Congress (I) was able to remain in power due to DMK's support from 1969 to 1971 (Krishna 1998). Furthermore, both the AIADMK and the DMK cooperated with various Central Governments from the 1970s up till today. Thus, the Central Government was keen on maintaining the support that had been exceeded by the Dravidian parties, and therefore had to make concessions to them.

DRAVIDIANISM AND SRI LANKAN TAMIL NATIONALISM, PRE-1980

In spite of there being two parallel Tamil nationalist movements in Sri Lanka and in Tamil Nadu, Krishna (1998) claims that the two nationalisms arose and evolved independently. They hardly had any contact nor did they have any emphasis on mutual ancient Dravidian heritage. In Sri Lanka, the Tamils' emphasis on heritage and history was principally towards their own country and not in the direction of south India, as Tamil political organisation in Ceylon around the time of independence was of an elitist pan-Ceylonese disposition. It was only when their alienation had become severe in the 1970s that they went across the Palk Strait to look for support, but before the early 1980s this was unsuccessful. The concerns expressed by the Dravidian parties on the Sri Lankan issue up till then were not directed towards the Sri Lankan Tamils from the north and east, but towards the Stateless Upcountry Tamils of Indian origin (Krishna 1998). Furthermore, the Dravidian movement in Tamil Nadu never included Jaffna or any of the Tamil-speaking areas in Sri Lanka in their sketches of a separate 'Dravida Nadu' – though it even included parts of Bengal. The dispositions of the movements were also different: While the nationalist sentiments of the Sri Lankan Tamils increased over the years, the opposite was the case in Tamil Nadu.

1983 – THE SRI LANKAN REFUGEES AND CHANGING LOCAL TAMIL POLITICS

After the 1983 riots, refugees started fleeing to Tamil Nadu. The Sri Lankan question became of concern for the people in the Indian state, and it eventually grew into a major political issue in Tamil Nadu. With this, the populist Dravidian political parties saw the potential to increase their political hegemony. Close links were built between Indian Tamil political parties and activists (primarily DMK and DK) on one side, and militant Sri Lankan Tamil groups on the other (Subramanian 1999). It was crucial for a Chief Minister candidate to support the Sri Lankan Tamil militants' struggle to be successful in the state elections in Tamil Nadu in the 1980's. Though the AIADMK generally exceeded a lesser degree of support for the Sri Lankan Tamils compared to DMK, they went on to support the LTTE on the precondition that the latter should refuse aid from DMK (Subramanian 1999). The Tamil Tigers accepted this, and DMK developed strong bonds to one of LTTE's most irreconcilable militant adversaries, TELO³⁰ (Gunaratna 1993, Muni 1993). AIADMK's collateral commitment to the militants – as compared to that of the DMK – is reflected by M.G. Ramachandran ceasing to support the militants when fighting erupted between the Tigers and IPKF. DMK on the other hand maintained its support to the militants, which eventually also came to include the LTTE (Tummala 1992). This endorsement came to have far-reaching consequences for the party in 1991.

In 1986, the Tamil Nadu Chief Minister, Karunanidhi assembled Indian sympathisers for the Sri Lankan Tamil cause and established an organisation, TESO (Tamil Nadu Tamil Eelam Supporters Organisation), with the aim of ending the animosity between the rival Sri Lankan Tamil militant groups. The conference was held in the South Indian city of Madurai, and was attended by several political leaders on national level³¹. However, the conference failed in its aim, the main reason was LTTE's assassination of TELO's leader, Sri Sabaratnam in Sri Lanka the day after the conference started. After this, Karunanidhi subdued his support of the Tamil militants but nevertheless continued tacitly to support the Sri Lankan Tamils.

³⁰ 'Tamil Eelam Liberation Organisation'.

³¹ Among them were current Prime Minister A.B.Vajpayee and the Janata Party leader Dr. Subramaniam Swamy (NGO staff, personal communication).

DETERIORATING RELATIONS

The attitude of the Indian Central Government and of AIADMK towards the Sri Lankan militants gradually grew cold. In a similar way, by the late 1980s and early 1990s, Sri Lankans had become less appreciated. One central cause was the highly unsuccessful IPKF operation in Sri Lanka. India had been humiliated by a small guerrilla group in a neighbouring country, a fraction of its size. They had to pull out after having lost more than 1100 of their armed forces, and without having achieved their intended goal. Rajiv Gandhi lost the elections, partly due to this unsuccessful operation³².

The presence of the Sri Lankan Tamil militants in India was also significant. Many groups were trained and assisted by both the central and the state government. Not only had they easy access to weapons which was more or less carelessly employed, but they also dealt with gems and drugs smuggling and other similar contrabands. There were major violent incidents involving Sri Lankan Tamil militants. In 1982, the archenemies Prabhakaran and Uma Maheshwaran, the leaders of LTTE and PLOTE respectively, accidentally bumped into each other outside a restaurant in Pondy Bazaar in Madras. They pulled out their guns and started firing at each other. In 1987 a shoot-out incident between some EPRLF militants and some local residents in Choolaimedu in Madras led to the death of an Indian who tried to stop the shooting (Narayan Swamy 1994). In 1985, a bomb exploded on an Air Lanka plane at Meenambakkam airport in Madras, killing 30 people. The responsible were found to be Sri Lankan militants from a small group called Tamil Eelam Army. Rajiv Gandhi, who took over as Prime Minister following his mother's death in 1984, came to the conviction that Eelam and the Tamil militants were against India's interests. Though he initially did not cut off the support for them, he gradually distanced himself from them.

A crucial event occurred in 1990. The Tamil Tigers assassinated the EPRLF-leader Padmanabha, 13 of his associates and one policeman in Madras. At this time, Tamil Nadu Chief Minister Karunanidhi was planning to re-organise a conference resembling that of

³² What actually led to his downfall was the 250 million USD Bofors scam. Bofors, a Swedish company developing defence systems, was awarded a contract for supplying 400 Howitzer 155 mm field guns which resulted in a huge economic loss to the Indian government. Those accused for the scam, among them Rajiv Gandhi, were then believed to be financially compensated for their favour by the Swedish company and its middlemen. Rajiv Gandhi was also accused of trying to suppress an independent Swedish investigation.

TESO³³ (NGO staff, personal communication). The plan was naturally ruined by this incident, and the Tamils from the island-state residing in Tamil Nadu were demanded to register themselves with the police. It was after this event that the Special Camps, as they exist today, were established. The change of attitude of the Indian government, from completely sympathetic during Indira Gandhi to almost unconditionally against in 1990, was noteworthy. In June 1990, Tamil Nadu Chief Minister Karunanidhi decided, after consultations with the Centre, that Tamil militants would be sent back to Sri Lanka. Sri Lankans were asked to register at the police and house-owners were asked to give details about Sri Lankan tenants (The Hindu 1990.06.28). In January 1991, Indian Prime Minister Chandra Shekar dismissed Tamil Nadu Chief Minister Karunanidhi for having links with the LTTE. Tummala (1992) however argues that this largely was due to pressure from Rajiv Gandhi and from the AIADMK-leader Jayalalitha.

FINAL REMARK

The deteriorating relationship between the Indian state, the AIADMK, the Indian population and the Sri Lankans generated over time due to a range of interrelated and mutually influencing factors. These are for instance the historical and political developments in India and Sri Lanka, the respective Central governments in power with their respective political agendas, the attitudes of the various State governments in Tamil Nadu, the political climate among the civil Tamil population, the position of the press, various activities of the Sri Lankan militants and so forth. There are in this context, of course, other more obscure, but nevertheless relevant aspects which have determined various pertinent conceptions, such as that of ethnicity and nationalism. Many of these conceptions were conceived or re-constructed in a colonial context. This was briefly outlined in the initial parts of this chapter. A further elaboration will however not be made here as this is beside my project. While the assassination of Rajiv Gandhi in May 1991 came to be seen as the event which irreversibly transformed the Sri Lankan Tamil identity and situation in India, one should have in mind that their situation already had deteriorated, as this chapter has sought to argue. Whether it at that point already was irreversible is difficult to say, but what happened in Sriperumbudur on May 21st undeniably made it so. In chapter eight, I will approach the assassination and analyse why this event came to have such profound effects in India and on the Sri Lankan

³³ Tamil Nadu Tamil Eelam Supporters Organisation, described in the previous section.

population. This chapter is thus contextually important for the discussions in chapter eight, as it presents important events and developing political formations and sentiments which led up to the assassination. Moreover, this chapter also encompasses important aspects for the other analytical and empirical chapters, as many of the events described in this chapter were referred to by Sri Lankans and the host population. As we will see, they were frequently emphasised and used to categorise and construct images of the other and were thus significant in people's identity negotiations. It is also important to have in mind these historical and political processes as we now move on to the Sri Lankan exile population in Tamil Nadu. As we will see, the influx of refugees largely corresponded with the shifting intensity of the Sri Lankan conflict, and the way they were received also reflected India's position on the Sri Lankan Tamil population in the wake of the assassination of Rajiv Gandhi.

Chapter 3 – Sri Lankans in India in local contexts

INTRODUCTION

In this chapter I will give a general presentation of the Sri Lankans' situation in India and of my field of research. In order to understand their situation better, I will commence by presenting how the Sri Lankans come to India and how they are received by the authorities. This will include the process of reception as well as the Indian refugee policy with focus on relevant national and international laws. I will subsequently give a presentation of the various categories of Sri Lankans in India; those who live in the local communities, those who live in camps, and those who live in the so-called Special Camps. My main focus will however be on the camp refugees, and though I will make references to this group throughout my dissertation, they do not represent a central focus. The reason for giving them so much attention is that they have a great comparative importance to the Sri Lankans who live in the local communities. As most Sri Lankans have at one point lived in a refugee camp before settling outside. A complete understanding of the Sri Lankans' situation can thus not be made without drawing attention to the living conditions of all groups of Sri Lankans in India, including the camp refugees. In the final part of this chapter, I will present the location in which I conducted my research. This will include a general physical description of the place, a demographic description, as well as a brief description of people's settlement and interaction patterns. These issues will be dealt with more extensively in the following chapters.

THE TRANSITION

There have been three major influxes of refugees from Sri Lanka to India corresponding with the political conflict situation on the island. As described in the last chapter, the first exodus began after the anti-Tamil riots in Colombo in July 1983 and lasted till July 1987, when the Indian Peace Keeping Force (IPKF) landed in Sri Lanka. The period 1983-87 has also been called the First Eelam War. As described in chapter two, Tamil Eelam is the homeland that LTTE is fighting for. With the IPKF on the island, some 25,000 refugees returned to Sri Lanka until 1989, when conflict again broke out, but this time between LTTE and IPKF. The

second batch of refugees started entering India in 1989 as IPKF began to pull out from the island. The Second Eelam War commenced the following year with renewed fighting between LTTE and the Sri Lankan Army (SLA). Between 1992 and 1995 some 54,000 refugees were forcibly repatriated to Sri Lanka. In 1995, when the SLA took control over Jaffna and the Third Eelam War began, the third refugee exodus from Sri Lanka to India set in.

Getting to India for the Sri Lankans is a strenuous experience, often involving a high risk to one's own life. The majority of the refugees, especially the poorer part from the north come illegally by boat by the help of local Tamil fishermen. Leaving their country for India by plane often involves large amounts of extra-costs to corrupt officials in the capital to obtain necessary travel documents. In addition, it may also involve a journey through the war-ravaged north-eastern regions to reach the south, a dangerous voyage which often takes days. The "easiest" and cheapest way to get to India is therefore by boat. Though the distance between Sri Lanka and India at the Palk Strait in the Gulf of Mannar is only 29 km, the journey is treacherous.

A boat journey from the Sri Lankan shore to India is organised with the local fishermen some days in advance. The journey is pre-paid, and frequently rather expensive³⁴ (Bastiampillai 1996, Suryanarayan and Sudarsen 2000). The transportation of Sri Lankan refugees across the strait has become a lucrative source of income for the fishermen, principally due to the high risk involved. The journeys are illegal and the consequences can be severe if the Sri Lankan authorities learn about such trips. The journey usually starts sometimes after dusk from the island of Mannar or from various locations in western Jaffna. During the early years of the armed conflict when the Sri Lankans were still approved of in India, they were dropped ashore close to Dhanuskodi near Rameswaram, or sometimes further north on the Indian mainland. However, a Naval Block has been established by the Indian Government to curb the increasing influx of refugees (The Hindu 2000.06.02, Times of India 2000.05.14). This has caused the fishermen to abandon the refugees on the Fifth, Sixth or Seventh Island of the

³⁴ People I spoke to told of prices ranging from 700 to 15,000 LKR depending on the size of the boats, and when the trip was taken. In 2001, 90 LKR corresponded approximately to one USD. The girl who paid 700 LKR for the trip arrived to Rameswaram in 1990, while the girl who paid 15,000 LKR landed in India in 1999. According to other Sri Lankans and people in OfERR (an NGO working with Sri Lankan refugees), the prices have risen manifold the last years. According to Suryanarayan and Sudarsen (2000), the prices can go as high as 30,000 LKR.

‘Adam’s Bridge’ in fear for being caught and having their boat confiscated by the Indian coastguard or police (The Hindu 2000.05.19, 2000.06.02). Adam’s Bridge is a strip of small islands, or rather sandbanks, stretching from Mannar to the Indian island of Pamban, where the sacred town of Rameswaram is located. The Indian Navy is not allowed to cross the International Border Line to rescue the refugees which are stuck on the Sixth and Seventh Islands, on the Sri Lankan side of the border (Times of India 2000.05.14). Stranded, the Sri Lankans have to wait to be picked up by Indian fishermen or by the Indian coastguard. But as part of India’s official policy to curb the influx of Sri Lankans into India (MHA 2003.05.30), the Indian authorities have ordered Indian fishermen not to pick up the refugees (The Hindu 2000.06.02). There are also accounts of the Indian Navy arresting and torturing fishermen, forcing them to ignore the cries of the stranded refugees. The Sri Lankan Coastguard who also patrol the sea to prevent the LTTE from smuggling weapons, often intercept the refugees. The Sri Lankan Navy has brought back a number of stranded refugees, where many have been charged before courts for leaving the country illegally (Refugee Council 1999).

The journeys across the Palk Strait are dangerous as they usually take place at night-time to avoid being seen by the Indian and Sri Lankan coastguards. The fishing boats are often filled to the brim with people and the weather in the area can be extremely harsh. Cheliyan, a refugee from Eastern Sri Lanka, told me that he crossed the strait in a boat which was no more than 10 meters long together with approximately 80 other people. He narrated that the sea was extremely rough. Some people vomited blood and later died. One lady also gave birth during the journey. In their despair, many people drank saltwater due to lack of fresh water. Cheliyan said he was so terrified that he was certain that they would never make it to India. There are several reports on tragic events during these voyages. On 19 February 1997, 165 Sri Lankans reportedly drowned when their boat capsized. Another tragic incident occurred in July 2000 when a newly married Sri Lankan girl was abducted by the fishermen who were bringing her and other Sri Lankans to India. Her dead body was washed ashore close to Dhanuskodi a few days later. The autopsy revealed that she had been raped before she was thrown over board and drowned (Dinamalar 2000.07.09, The Hindu 2000.07.08).

After landing on Indian soil, the refugees are taken in for interrogation by the police and a special branch of the Tamil Nadu police – the Q-branch – to determine eventual LTTE links.

The Q-branch is, according to the South Asia Human Rights Documentation Centre (SAHRDC) known for its ruthlessness, for its illegal arrests, unacknowledged detention, torture and harassment of unwanted so-called ‘anti-national’ elements such as the Naxalites³⁵ and LTTE people³⁶ (SAHRDC 2002.02.25b). Though most Sri Lankans tell of decent treatment by Indian officials when being interrogated, others narrate of abusive behaviour by the police and the Q-branch. People’s Watch, an NGO dealing with human rights issues, has described the interrogation procedures at the Dhanuskodi police station as “harsh” (Indian Express 2000.06.09). The Sri Lankans are most frequently questioned about militant links, which militant group they support, the reason for coming to India, when they intend to return, the price of the journey, who the boatman was, what the boat number was, from where the person came from in Sri Lanka, if any others are waiting to cross etcetera. The Sri Lankans are subsequently transported to the five acres large Mandapam camp on the mainland not far from Rameswaram, which is the transit camp for newly arrived Sri Lankan refugees. The Sri Lankans are subject to new interrogations before they are lodged in the camp. Sri Lankans who are discovered to have LTTE links are detained and sent to the so-called ‘Special Camps’. These are high security camps established especially for militant Sri Lankans. But some Sri Lankans are also detained in these camps under the Foreigners Act for illegal entry even after being cleared by courts of suspected militancy (Refugee Council 1999, SAHRDC 2002.02.25a, UNHCR 1999). As the Mandapam camp is a transit camp, the Sri Lankans are later relocated to other refugee camps in the various districts of Tamil Nadu. Others again, are able to establish a life outside the camps.

INDIAN REFUGEE POLICY AND THE REFUGEES IN INDIA

The UNHCR was established by the United Nations General Assembly in 1950, with the mandate to provide international protection for refugees and to assist governments to find lasting solutions on refugee problems. It currently cares for some 22 million refugees and is the principal humanitarian organisation working with displacement.

³⁵ The Naxalites consist of several Maoist Revolutionary groups from different parts of India as Bihar, Madhya Pradesh, Orissa, Andhra Pradesh, Maharashtra and Tamil Nadu. They are infamous for their violent acts, including assassinations of suspected police informers, village leaders, and others considered “class enemies” or “caste oppressors”. The name stems from Naxalbari, a village in the northern part of West Bengal, where poor and landless peasants, tea plantation workers and tribal people in 1967 revolted against exploitation and oppression.

³⁶ LTTE was banned in India following the assassination of former Indian Prime Minister Rajiv Gandhi.

India was elected into the Executive Committee of the UNHCR in 1994, but like the other South-Asian countries, it has not ratified the 1951 UN Convention and the 1967 Protocol to the Status of Refugees. None of the South Asian countries have adopted any domestic laws on refugees or asylum, but some articles of the 1951 Convention are applied by India in the handling of refugees (Bose 2000). India is also a signatory to the United Nations Declaration on Human Rights (UDHR), which has certain provisions for the right to seek asylum. As there is no current framework under which the Indian constitution determines the status of refugees, the country's dealings with the refugees are done in ad-hoc manners (Chandrasahana 1989, Kaur 2002, SAHRDC 2002.02.25a, Suryanarayan and Sudarsen 2000). Handling of refugees is largely based on the Registration of Foreigners Act (1939), the Foreigners Act of 1946 and the Passport Acts of 1920 and 1967. These are applicable to foreigners and regulate the entry, presence and departure of aliens in India (Suryanarayan and Sudarsen 2000). The poor legal status for refugees in India, is according to Kaur (2002) comparable to that of foreigners whose movement can be restricted or who can be ordered out of the country. Under the Foreigners Act, they are dealt with like ordinary aliens.

India has nevertheless been rather benevolent towards refugees, and by the end of 2000 provided refuge and shelter for approximately 250,000 refugees (Kaur 2002); mainly from countries such as Sri Lanka, Bangladesh, Myanmar, Tibet, Bhutan, Afghanistan, Iran, Iraq, Somalia, and Sudan (SAHRDC 2002.02.25b). The Sri Lankans who live in the local communities are not considered as refugees by the Indian government. Most of the refugees are under care of the UNHCR. But the Sri Lankans Tamils and the Jumma (Chakma) refugees from Bangladesh are under care of the Government of India³⁷.

The Sri Lankan Tamil population in India constitutes of an approximate 200,000 people and can generally be classified into three categories. The first group consists of Sri Lankans living in various refugee camps in Tamil Nadu and in one camp in Orissa. The second category of Sri Lankans are those identified as militants. They are detained in three Special Camps; Tipu Mahal in Vellore Fort, Chengalpattu, and Melur in Madurai District. The third group, which are the subjects of my research, are the Sri Lankans outside refugee camps. They have mainly settled in the greater Indian Tamil cities, principally Madras, Madurai and Trichy

³⁷ According to SAHRDC, by 1986, nearly 70,000 Jumma refugees sought shelter in six refugee camps established by the Indian government in the Indian state of Tripura (SAHRDC 2002.02.25a).

(Tiruchchirapalli). As in Malkki's (1995a) study on Hutu refugees from Burundi in Tanzania, exile as a collective experience was perceived radically different between camp refugees and those who had settled in the various townships and cities. One more category of people should be mentioned, namely the 'repatriates'. These Tamils from the Sri Lankan Hill Country lost their citizenship on the island when the country became independent, but many received an Indian citizenship during the last few decades. In spite of this, many still identify themselves as Sri Lankans.

CAMP REFUGEES

According to the Indian Ministry of Home Affairs, approximately 65,000 refugees were accommodated in 116 camps in 2001 (MHA 2004.02.16)³⁸. Additional to the camps in the south-eastern state, one refugee camp is located in Orissa. According to UNHCR (1999), only the Sri Lankans residing in camps are regarded as refugees by the Government of India. There is a demographic difference regarding settlement among the Sri Lankans in India. Sri Lankans in the camps come from the Tamil dominated Jaffna peninsula, the East coast and from areas like Vavuniya, Mannar, and Killinochchi, as well as from the Sri Lankan Hill Country, while the people who reside outside the refugee camps are predominantly of Jaffna origin (NGO staff³⁹, personal communication).

OfERR

In 1993, as a direct consequence of LTTE's assassination of former Indian Prime Minister Rajiv Gandhi, sets of restrictions were imposed on the refugees. An education ban was introduced, and all NGOs (including UNHCR) were banned and restricted from working in the camps with the refugees. One NGO was nevertheless able to continue its work inside the refugee camps; this NGO is the Madras-based OfERR (Organisation for Eelam Refugee Rehabilitation). OfERR and its more politically oriented sister organisation ProTEG⁴⁰ were

³⁸ The number of refugee camps is altering, as camps are opened up and closed down every now and then. OfERR operate with 116 refugee camps on their homepage when it was accessed 25. February 2002. Suryanarayan and Sudarsen (2000) state that there in December 1999 were 123 camps, while The Refugee Council (1999) in August 1999 and UNHCR (1999) refer to the existence of 131 camps.

³⁹ This person wishes to keep himself as well as his NGO anonymous to avoid trouble from Indian authorities. He stressed that he preferred not revealing sensitive information to the media concerning the Indian government's treatment of the Sri Lankans as he expected the government to take action against his NGO, which would thwart their work further. He told of incidents where he had had trouble with the authorities for dealing with Sri Lankan issues.

⁴⁰ ProTEG: Organisation for the Protection of Tamils of Eelam from Genocide and other Violations of Human Rights.

founded in 1984 and are non-profit NGOs, run by and for Sri Lankans. On OfERR's homepage, their main objectives are stated to be: "Assisting and rendering relief to Tamil refugees from Ceylon who had taken refuge in India" and "to empower the refugees to be on their own feet and sustain themselves while they are in India and be able to help in rebuilding their homeland on return" (OfERR 2002.02.25). Funding from other foreign NGOs based in Europe, Australia and Canada are facilitating OfERR's relief programmes. The organisation comprises not only of Sri Lankans, but also of Indian relief workers. The organisation has 384 volunteers, of whom the majority are living in the camps. 44 co-workers work at OfERR's main office in Chennai in implementing the organisation's programmes through four regional offices situated in Chennai, Trichy, Erode and Tirunelveli. The regional office staffs coordinate the work with district volunteers who facilitate camp refugee's work, as for instance health work and nursery work. Every month coordination committee meetings are held both at district and at state level to review progress and finances (Soosai 1998).

OfERR has a number of welfare programmes and services for the camp refugees with the aim of improving the quality of life in the camps. Refugee participation is central in their programmes and services. With the assistance of the government, OfERR's ongoing programmes include: Counselling; Educational assistance; Medical assistance; Special Programmes for women and children; Nutrition supplement for children up to five years of age and nutritional supplement for pregnant women and lactating mothers; Technical and vocational training; Income generating activities; Supply of relief material to camp refugees; Assistance to returnees; Refugee integration; and Refugee resettlement. OfERR also assist in maintaining housing facilities, repair of toilets, boring for well pumps, electrical repair and such within the camps (Soosai 1998).

Economic and social situation

A number of the refugees in the camps are from the poorer stratum of Tamil society. Many have lost their properties due to the war and some had to run away in a hurry and leave everything behind. Some refugees have previously been in Western Europe, Canada or other places, but have been sent back to Sri Lanka after having their asylum applications rejected. They have managed to come to India, but now have no more money to re-attempt to go to Europe, nor to settle outside the camps. Some have relatives in Europe, but few of these receive economic support. Those who receive support experience improved life conditions

and in some camps, as Mandapam camp for instance, they are able to attain certain benefits by bribing camp officials. In 1990, the Government of India fixed a dole for the Sri Lankan refugees⁴¹. Relief expenditures spent by the State Government of Tamil Nadu on the Sri Lankan refugees are reimbursed by the Central Government (MHA 2003.05.30).



Sri Lankan refugee camp in Tamil Nadu.

Due to poor economy, many refugees have problems that expand beyond the economic sphere and influence people's lives on the social level. Due to the expectance of dowry, some of the people I spoke to are not able to marry off their daughters or sisters due to lack of economic resources. According to OfERR-staff, there has also

been a change in what has been described to me as 'traditional family' and 'social structures'. There are incidents where Sri Lankan men living abroad come to refugee camps allegedly to find a spouse, and promise unmarried girls a "happy life" in Europe. Many of these men are already married, and after having exploited the refugee girls sexually, they return to their country of residence leaving the girls behind⁴². A girl who has lost her virginity has limited hopes of getting married at a later stage, and the situation is even worse if she becomes pregnant. I will return to this issue in chapter seven.

⁴¹ The monthly dole allotted were set to: Head of the family: 150 INR, Spouse: 120 INR, First child: 75 INR, Second child: 37,50 INR, and Family of four: 382,50 INR (Refugee Council 1999). One USD was in 2000-2001 approximately equivalent to 45 Indian Rupees.

⁴² Such sexual exploitation of women also occurs outside refugee camps.

There is limited privacy in the camps, and many people may share the housing facilities (2,5m x 2,5m). Others have lost their relatives or do not know their whereabouts, and are alone in the camps. Experience of shock and traumas can also influence and further deteriorate living conditions in the camp. There is a certain frequency of violence connected to alcoholism in refugee families. According to Soosai (1998), a survey done by Dutch Interchurch Aid in November 1995 concluded that 32% to 53% of the children in the refugee camps were moderately to severely under-nourished and under-weight during the years 1993 to 1995. High frequency of physical illness as anaemia, dental caries, impaired mobility, vision, speech and hearing as well as concealed disabilities like chronic malnutrition, diabetes etcetera has been recurrent (Soosai 1998). Soosai further states that 20% of the camp population suffered from mental health problems as anxiety, depression, attempted suicides, obsessive-compulsive thoughts and mental handicaps in 1998. Many of the refugees who suffer from recoverable diseases are not receiving help from local doctors due to insolvency, but may receive help from OfERR to get medical treatment.

Freedom of movement, work and education

The 1993 ban on NGOs also restricted the camp refugees' freedom of movement and possibility for education. The authorities' strictness on entering or exiting camps varies from place to place. Most Sri Lankans are allowed to work outside the camps, but must return daily. A curfew imposed after the assassination restricts the Sri Lankans' movement outside the camp between 6 pm and 8 am. In some camps employment is possible in the nearby areas, but such opportunities strongly depend on the location of the camp. According to The Refugee Council (1999), refugees who are compelled to stay far away from their camps for longer periods for work due to the camps' remoteness, risk to lose their registration in their camp. On some occasions refugees in regular camps have to pay bribes to the Q-branch⁴³ to get an approval to include relatives on their Refugee Card (the refugees ID-card), or to be allowed to exit camps⁴⁴. Yet, many refugees never encounter any problems with the police or authorities. Concerning the Mandapam camp, I was told of an unofficial list of prices for obtaining certain facilities or for having different things done by the police⁴⁵.

⁴³ The Q-branch is a branch of the police established to deal with anti-social groupings or organisation as the Naxalites and the LTTE.

⁴⁴ After having been registered with Indian authorities on arrival in India, all refugees receive a Refugee Card. All family members should be included in this.

⁴⁵ The informant told me: "*You can get everything done in the camp, it only depends on your payment capabilities*".

After three years, in June 1996, a ban on education introduced shortly after Rajiv Gandhi's assassination was lifted. The same year, 90 refugee students were admitted to take higher education. In 1999, there were 22,000 refugee children in school age. The refugees also have the possibility to join certain courses organised by OfERR (e.g. management and leadership courses) where they learn to handle problems and difficulties within the camps.

Camp lodging

The banning of NGOs to work in the refugee camps affected the living conditions in the camps (SAHRDC 2002.02.27). While cyclone shelters more or less have been abandoned as camp accommodation, most camps housing facilities comprises of permanent or semi-permanent buildings. A good number of the huts were built several years ago, and many of the newly erected houses are subject of complaints due to bad construction material, bad roofing and little space. The warm season and the monsoon deteriorate living conditions further. The hygienic conditions are often poor, whether due to lack of water or because of inadequate toilet facilities or conditions. People are forced to use open spaces instead, which lead to the spreading of diseases. Some camps have shops where the refugees can buy basic commodities, and some refugees have small gardens where they cultivate vegetables. A number also have schools and most camps have places for religious worship. The programmes organised by OfERR has improved the living conditions of the camp refugees.

MILITANTS IN SPECIAL CAMPS

The second category of Sri Lankans in India consists of the people who are suspected of being militants. These are detained in the three previously mentioned Special Camps in Tamil Nadu⁴⁶, which were established in 1990 following LTTE's assassination of Sri K. Padmanabha in Madras. Padmanabha was the leader of EPRLF⁴⁷, one of LTTE's main militant rivals (see chapter two). According to UNHCR (1999), approximately 150 militants lived in these camps in 1999. This number is not constant, as some have been deported to Sri Lanka; some have been permitted to go abroad, while new ones have been detained. Sri Lankans in Special Camps live under extremely difficult conditions and are denied all excess to the outside world, which have resulted in loud protests from Human Rights organisations (Newindpress 2003.06.10). People's Union for Civil Liberties, an organisation consisting of

⁴⁶ Tipu Mahal in Vellore Fort, Chengalpattu, and Melur in Madurai District.

⁴⁷ Eelam People's Revolutionary Liberation Front.

lawyers, and one of the few organisations allowed into the Special Camps, describe the life in the camp of Tipu Mahal in this way:

“Life in the Special Camps is very harsh and the conditions are worse than the conditions prevailing in many central prisons. The inmates held in the camp do not enjoy any of the privileges that even convicted prisoners enjoy... They are in reality held indefinitely without any possibility of coming out and leading a normal life. Many of them have been incarcerated in the camp for many years with some even being imprisoned for almost a decade. Conditions imposed by the police and other security agencies is so stringent that it is almost impossible for relations and friends to meet any of the refugees held as inmates in the camp” (PUCL 2000:1).

As stated initially, many Sri Lankans are also detained in these camps under the Foreigners Act for illegal entry even after being cleared by courts of suspected militancy (Refugee Council 1999, SAHRDC 2002.02.25a, UNHCR 1999). Others are detained under this act without trial. Many young non-militant Sri Lankans as well as elder women are said not to know the reason why they have been arrested and detained in the Special Camps (Newindpress 2003.06.10, SAHRDC 2002.02.25b). There have been reports on militants on the verge of being deported to Sri Lanka. One former militant named Napoleon was given a deportation order. After massive protests from local and foreign NGOs who claimed that deportation would represent a serious danger to his life, his deportation was stopped at Madras International Airport, only minutes before he was to embark the plane that was to bring him back to Sri Lanka⁴⁸.

SRI LANKANS OUTSIDE CAMPS

The third and final group represents the people on whom I conducted my research, namely the Sri Lankans who live in the local Indian communities. They represent the largest group and number between 80,000 and 100,000, depending on the source and on the political situation in Sri Lanka. This number is uncertain due to the many unregistered Sri Lankans in the state⁴⁹. While many come by boat or by plane as described initially, some come on tourist visa issued by the Indian High Commission in Colombo and continue to stay in India after the expiry of their visa. The majority of the Sri Lankans living outside refugee camps have

⁴⁸ Reference to this incident has not been obtained, though I have seen a copy of the official deportation letter. The owner of the letter was scared to give me a copy due to the risk of getting in trouble with Indian authorities.

⁴⁹ SAHRDC (2002.02.25a) for instance refer to sources claiming the number of Sri Lankans living outside camps of being close to 100,000, though their sources are not specified in their document

settled in the urban areas of Tamil Nadu. The largest concentrations are in Madras, Madurai and in Trichy, the latter due to its international airport connecting the island-state to India. There are also large Sri Lankan communities in many other Indian Tamil cities.

Official status of the Sri Lankans

Before I turn to describe the field and place where I conducted my research, I will present some important aspects regarding Sri Lankans legal status and general situation, as this largely determines their social practices and possibilities. As previously stated, it is important to bear in mind that the Sri Lankans who live outside the camps without visas are not considered refugees by the Indian Government, and have a status comparable to that of ordinary aliens (Kaur 2002). For this reason Sri Lankans are compelled to hold a valid visa or police registration at all times. When their visa expires, police registration is normally sufficient to prolong their stay in India. The police provide a Registration Number, which the person is expected to quote whenever issues related to living in the state arise. Sri Lankans working in India are expected to obtain an official work permit before starting to work. Sri Lankans resident in India for five years or more, as well as those who are married to Indian citizens, may apply to be included in the electoral list. They may also receive Ration Cards, which makes them entitled to certain consumer goods at subsidised prices. Yet, many Sri Lankans have neither received Ration Cards, nor have they been included in the electoral lists, in spite of continuous applications.

RAJA NAGAR AND ITS SURROUNDINGS

Differently from the refugee camps, a life in the local communities presupposes certain economic assets, or relatives who already live outside camps in India who may ease their transition from a camp location to an urban or semi-urban one. The Sri Lankans often reside in areas with high concentration of other Sri Lankans. Consequently, many Sri Lankans do not socialise much with the host population. My fieldwork was conducted in an area with a sizable Sri Lankan population.

THE LOCATION

The city in which I lived, Akhadipuram is a substantially sized thriving commercial city. It has many hotels where both western and Indian visitors come to stay. While some come for commerce or business often from surrounding villages, others come as tourists or as pilgrims

to visit the city's various temple complexes. It is in many ways a typical Indian city, crowded and swarming with life during daytime, and relatively calm after sunset. It has a vibrant old-city with labyrinthine narrow streets populated with street vendors and playing children.

The suburb of Raja Nagar, a 45 minute bus-ride from the centre of the city is a dry semi-rural area. Housing here principally consists of permanent concrete bungalow and villa habitations, but there are also some bamboo constructions which mostly are used as shopping facilities, stores and as greengroceries. On occasions however, such bamboo constructions may also be used for habitation. The web of paved roads, dirt tracks and paths are crisscrossing through the dry, shrubby and plane landscape. The area is fast growing and a large number of new houses were constructed in the area during my ten-month fieldwork, many by Sri Lankans. When I returned in December 2002 for a short period, one year and nine months after having departed from my initial fieldwork, certain areas were almost unrecognisable due to the extensive building. Many of the edifices are large whitewashed constructions several floors high with tiled entrances and flowery gardens. Most houses are nevertheless one-floor concrete buildings. Baking heat and little rain have made the vegetation in the area dry. It is dominated by shrubbery and bushes, and with coconut trees and fan-leaved palmyra palms. Raja Nagar is a quiet place weighed against central Akhadipuram. The characteristic drowning sounds of Indian bus horns and the croaks of the *autos*⁵⁰ appear only sporadically in Raja Nagar. The roads in Raja Nagar are however seldom empty. People, cows, goats and dogs; bikes and motorbikes; bull-carts, autos, and cars make their imprints in the landscape during daylight hours.

The population of Raja Nagar is multi-religious with a Hindu majority, although with sizeable Muslim and Christian communities. The Christian population consists both of Roman-Catholics as well as Protestants, such as Pentecostals and Seventh-Day Adventists. Several Churches, Mosques and Hindu-temples were located in my neighbourhood in Raja Nagar. The chanting of the muezzins, the bell-tolling from the churches and Hindu *kovils*⁵¹ and the mantras and chants of the Brahmin priests during Hindu festivals and *pujas*⁵² are part of the daily life of Raja Nagar.

⁵⁰ A small three-wheel vehicle used as taxi.

⁵¹ Hindu temple.

⁵² Worship.

CASTE AND GEOGRAPHICAL ORIGIN

While most Sri Lankans in Raja Nagar came to India as refugees from the war, others came due to family problems or financial difficulties. Sri Lankans affected by the conflict varied between Colombo Tamils who had been affected by the anti-Tamil riots in 1983 (see chapter two), to those from the north and east who fled from combating or from political persecution.

The majority of the Sri Lankans in Akhadipuram in general, and in Raja Nagar in particular, were from the northern Jaffna peninsula. Besides Jaffna town itself, they were from its near rural surroundings and from the northernmost coastal areas of Point Pedro and Valvettithurai. The Tamil dominated north⁵³, which includes Jaffna town – considered the cultural-historical capital of the Sri Lankan Tamils, has been severely affected by the armed conflict. Furthermore, Raja Nagar also had a sizeable Sri Lankan population who had their origins from Colombo, and some who were from the central Sri Lankan Hill Country. The differences between these two groups were sometimes blurred, as many Colombo Tamils were originally from the Hill Country. A significant feature regarding origin of the Sri Lankans in Raja Nagar was however the distinctly smaller number of people from other traditionally Tamil or Tamil dominated areas on the east coast and in areas and towns such as Mannar, Vavuniya, Kilinochchi and Mullaittivu. As earlier stated, most of the Sri Lankan refugees from these areas, as well as from the Hill Country were living in refugee camps. The majority of the Sri Lankans from Jaffna in Raja Nagar were also of higher caste origin, being either *Vellalas*, which is a farmer and landowner caste, or belonging to the *Karaiyar* community. The former is the highest ranking caste (*jati*) among the Sri Lankan Tamils, which numerically constitute the absolute majority of the population on the peninsula (Wilson 2000). The Karaiyars on the other hand is a fisherman caste from northern Jaffna. It is the community from which the LTTE had its naissance, and this *jati*'s link to the Tigers is known to be particularly strong. Many of the Jaffna Tamils, both Vellalas and Karaiyars were relatively well off economically due to financial support from relatives living abroad.

⁵³ In 1981, before combating erupted, Tamils comprised 92% of the total population on the peninsula (Wilson 2000).

THE WIDER LOCALITY – EXTENDED SETTLEMENT PATTERNS

The degree of dispersal among Sri Lankan families was prominent, and also had far reaching social implications. These bonds, in a crucial way, contributed economically to the Sri Lankans' life sustenance. The majority of the Sri Lankans of Jaffna origin had several relatives living in other countries, ranging from Sri Lanka, various Western European countries, Canada, Australia, the Middle East, to some of the South East Asian countries. As many Sri Lankans received money from relatives abroad, a good number had an economy which surpassed that of most Indians in the area.

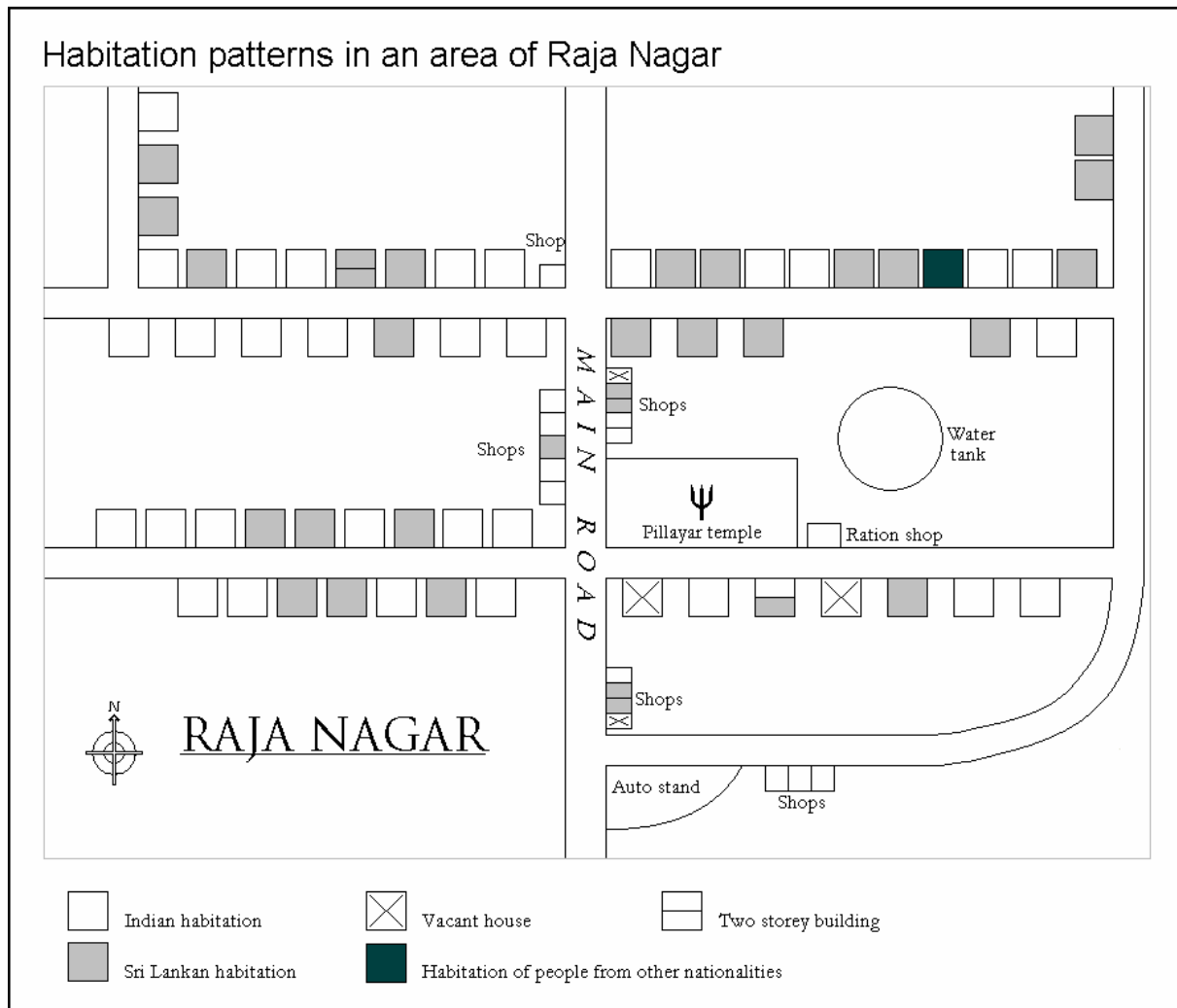

Besides those who had relations abroad, from whom they received remittances, many Sri Lankan established private enterprises and businesses to secure an income. Sri Lankans have problems to get work in India. As foreigners, they cannot be employed in government jobs, which generally are better paid than private employments. Many big hotels, shopping complexes and private establishments in Tamil Nadu are owned by Sri Lankans.

SOCIAL LIFE AND INTERACTION

People in Raja Nagar were of fairly diverse backgrounds. Apart from the majority of Indian Tamils, a few people in the area originated from the Middle-East, and a fair amount of people were from the neighbouring states of Kerala and Andhra Pradesh. Others who distinguished themselves from the majority of Indian Tamils were the Anglo-Indians, who were of mixed British/Irish-Indian ancestry. Then there were the Sri Lankan Tamils who constituted a substantial share of the population in the part of Raja Nagar where I lived. The majority of the Sri Lankans were Hindus, but many were also Christians. The contact and interaction between the different peoples varied, but as a general trend, the Sri Lankans did not interact much with the Indian population. Apart from Raja Nagar, some of my informants resided in other areas of the city which had a smaller concentration of Sri Lankans. Some who lived in the central parts of Akhadipuram generally had more contact with Indians than those living in areas with many Sri Lankans.

The spaces in which the Sri Lankans in Raja Nagar socially engaged consisted of people's own homes, local shops and the adjacent roadsides, as well as the temples. One of the most common places for social gathering and interaction was people's houses. When visiting each other, people often came to recount or hear the latest political developments in Sri Lanka, or to tell or get news about relatives or friends in Sri Lanka or in the West. But people also got together only to chat or to hear the latest gossip about people in the neighbourhood. Apart from the socialising that took place in the houses, much social interaction was conducted outside. The marketplace which is a customary place for social interaction was located in the centre of the city, but much of this intermingling, chatting and exchange of news from or about friends and relations also took place by the small roadside shops. Furthermore, people got together during religious events and festivals. During *Deepavali*, the festival of light⁵⁴, people visited friends' and relatives' houses with homemade sweets, and during the Tamil Thanksgiving - *Pongal*⁵⁵, homemade pongal (also the name of a dish⁵⁶) were distributed to

⁵⁴ During the four day long festival of *Deepavali* or *Diwali* (which it is named in North India), people fire firecrackers, invite friends and neighbours to their houses and pay tribute to the gods for attained success.

⁵⁵ *Pongal* (*Thai Pongal*) or Tamil thanksgiving (usually the middle of January – when the sun passes from Sagittarius to Capricorn) marks the transition from the “inauspicious” month of *Margazhi*, to the “auspicious” month of *Thai*. It is a festival of gratitude to the sun for sunlight and for the crops it has provided.

⁵⁶ *Pongal* is made from rice, sugarcane, ginger, turmeric and honey.

visitors. In January, many Sri Lankan families lodged Sri Lankan Sabarimala pilgrims⁵⁷, for whom they frequently arranged lunch and *pujas*⁵⁸. The pilgrims visited numerous sacred sites all over Tamil Nadu before going to the Sabarimala shrine in the neighbouring state of Kerala. On such occasions, pilgrims usually stayed with friends and relatives. During the pujas and the meals, the Sri Lankans from the whole neighbourhood came to participate, and to meet friends or relatives who came as pilgrims.

Before engaging in my theoretical and analytical discussions, it will be necessary to address significant challenges related to conducting a fieldwork in the location described. Doing a fieldwork in this context was not unproblematic as my research was highly politicised, largely due to the assassination of Rajiv Gandhi. As we will see, this event did not only have great impact on the daily comportment of my Sri Lankan informants, but also on how I had to conduct my fieldwork. The following chapter is important as it problematises my role as a researcher, the gathering of information in a social context which is highly politicised, as well as it takes into account problems related to having female informants and conducting a fieldwork in a relatively bounded location where people are highly influenced by family bonds which exceeds national boundaries.

⁵⁷ Sabarimala, in the hills of Kerala is considered one of the most sacred places in Southern India. The site is a shrine built to the worship of Ayyappan, Siva's third son (after Pillayar/Ganesha and Murugan/Skanda). He was the offspring of the union of Siva and Mohini, a female manifestation of Vishnu. Ayyappan is the god of celibacy, and is said to teach the principle of brotherhood for people to remain happy and peaceful. The black-clad Sabarimala pilgrims come from all over India and Hindu Sri Lanka to visit the place during the "festival season" from December to January. For a more detailed account of this pilgrimage, see Daniel (1984).

⁵⁸ Religious offerings.

Chapter 4 – Reflections on fieldwork challenges

INTRODUCTION

Before I left for India, I took contact with OfERR, whom I got in touch with through some Tamil contacts in Norway. On the way to India, I also met representatives from two organisations in London⁵⁹ who presented some of the problems the Sri Lankans in India were facing, and also some of the challenges that I probably would face while conducting a research on Sri Lankans in India.

My entry into the field was complicated. It took me several weeks to find a suitable location for my fieldwork and win people's trust, in order to meet them on a regular basis. I initiated my stay by spending some weeks with OfERR at their main office in Madras, collecting information about the situation of the Sri Lankan refugees, until I saw the time to be appropriate to move on "into the field" to start my research on the Sri Lankans who lived in the Indian communities. My original intention of making a comparative study between the Sri Lankans inside and outside the refugee camps proved to be too difficult. I would not get regular access to the camps, and had to be content with doing a research on Sri Lankans outside camps alone.

When I first arrived to Akhadipuram I was, with the help of OfERR, introduced to Chandran, an Indian with Sri Lankan heredity whom I stayed with for about a month. I was told that he knew many Sri Lankans, but I soon realised that his Sri Lankan friends were scared not only to speak to me but also to meet me. On one occasion while I was in my room, one of his Sri Lankan friends came to visit him. Chandran told him about me and that I was doing a research on Sri Lankans in India, and wondered whether I could ask him a few questions. He asked Chandran what kind of questions I was going to ask, and got the answer that it would only be general questions about his life in India, about the Sri Lankans'

⁵⁹ British Refugee Council (BRC) and Tamil Information Centre (TIC).

relationship to the local people and such things. According to Chandran, his friend sounded relieved and agreed. Chandran went up to my room where I was having my breakfast and told me that I could interview his friend when I was finished. But when I came down he had just left to pick up a friend but he would be back in a couple of minutes, he told Chandran. These minutes lasted my whole fieldwork, and during the ten months that my fieldwork lasted, he never returned to Chandran's place. After a series of disapproving responses from other Sri Lankans in the neighbourhood, I decided to talk to OfERR again. They recommended me to move to a suburb in the city called Raja Nagar where there were many Sri Lankans. But I needed a place to stay, as this was too far away from Chandran's place. Some of their employees investigated and found a family with a spare room. This was Jeyadhani's house. She was a Karaiyar from Valvettithurai who lived in Raja Nagar with her husband and three of her sons. They came to India in 1993 due to the conflict. I moved in, expecting the great redemption. But I soon realised that people were equally sceptical and scared in Raja Nagar as they had been in Chandran's neighbourhood. Jeyadhani and her family were for instance reluctant to tell their neighbours and even their own relatives who lived close by about my purpose for staying in their house. "*He is a Tamil student*", they told people. I had to respect their wariness, but for my fieldwork it was unsatisfactory in the long run. How could I do a fieldwork without letting people know what I was doing? Eventually, I got to know more people in the area who also started to trust me and who gave me more and more elaborate responses. After some time I moved out from Jeyadhani's house and rented my own house. A breakthrough came with the acquaintance of Ambiga and Rajkumar who were friends of, and lived close to Jeyadhani. Ambiga and Rajkumar were from the Hill Country and the East coast respectively, and settled in India in 1993 following family problems related to their love marriage. Through them, I met most of my other informants, and they always took time to answer my questions and to give me any information that they thought was important for my research.

The fear that people had for speaking with a stranger never disappeared altogether, but it improved, much due to the help of Ambiga and Rajkumar, but I believe also due to the length of my stay. I became a familiar face, and though I had to conceal my real purpose for security reasons to people that were not and who were not going to be my informants, I managed to build up a certain confidence with people. It is however important to mention also that some people with "dubious" backgrounds, were not scared to speak.

FEAR AND SENSITIVITY

Fear and suspiciousness was a factor that influenced my fieldwork in a significant way. It affected people's openness, how they acted towards me as a stranger, how they formulated their life-histories, and how they generally behaved. Selvaraj, one of Jeyadhani's sons was keen to know whether the information that I collected would be made available to the government. He also wondered if it would be possible for outsiders to identify people in my thesis. His wariness was clearly reflected in his lacking openness. The sensitivity of my topic of research, and the fact that I was a 'subject of interest' of the Indian intelligence, was also reflected in the way I conducted my research.

Trust and power as methodological factors

The fear that was mediated to me from the Sri Lankans through their silence, evasiveness, or "lies", but sometimes also directly, was related to the surveillance exercised by the Q-branch, and corrupt bureaucratic dynamics which often affected them. These are aspects that will be extensively approached in chapter eight. Central in this context is the unconscious and embodied concept of "trust", which Daniel and Knudsen (1995) compare to Bourdieu's notion of 'habitus' or to Heidegger's concept of "being in the world". Trust, relates to circumstances where one conceives a sense of safety or where one exercises certain measures of control towards one's environment. "Mistrust" on the other hand, represent a conditions where trust have been destroyed or seriously damaged, and where unfamiliar new realities and socio-political circumstances threatens one's way of being and which forces the person to see the world differently (Daniel and Knudsen 1995). I argue that the social insecurities and the lack of civil rights, as well as the surveillance, corruption and fear of sanctions – as for ending up in a Special Camp, generate a sense of mistrust among many Sri Lankans in India. But, central in this argument is not only the sense of mistrust conceived, but the way that this insecurity and mistrust towards their environment is manifested and reproduced, and how this influenced my fieldwork.

This relates to notions of power, but I argue that the fear and insecurity itself is as powerful in conforming people's behaviour as the actual dynamics of control. Though these dynamics largely are instrumental and can be localised to certain institutions, they also represent facets of a disciplining form of power, of what Foucault has labelled panopticism (Foucault 1999b). Panopticism is represented by a context where the 'centre' can see everyone. People can

neither see the 'centre' nor do they know when it sees and when it does not. It is their knowledge that the 'centre' may be seeing them that in itself is disciplining. Disciplining power is not localisable and not in anybody's hands, it is circular and netlike organised. People are themselves – in this case manifested by the Sri Lankans' fear of these dynamics and for ending up in the dreaded Special Camps – vehicles for this disciplining power, and not the points of its application (Foucault 1980:98). Though the aspect of power, surveillance and corruption will be drawn attention to more extensively in chapter eight, I find it imperative to emphasise the existence of these dynamics here as it influenced my fieldwork in a fundamental way. Surveillance and the fear of sanctioning disciplined people's conductance and practices, including their openness towards me, maybe more than the actual surveillance and corruption in itself. Aadalarasu, a former militant said on one of the last days of my stay in India, that even though he knew me well, he could never be certain that I did not have any connexions with the Sri Lankan government or with the Q-branch. His statement illustrates well the nature of my general rapport with people, including Indians. People would understandably avoid telling me sensitive information that could link them to the LTTE in one way or the other, if there was even a slight chance that the information would end up with the authorities. The Tamils from Jaffna were naturally the most evasive, as they were the most likely to have LTTE-connexions.

Sensitivity and the collection of data

Suspicion, fear and the existence of dynamics of control sensed and experienced by many people in Raja Nagar influenced not only the way in which I associated with people, but also my practices of collecting data. Though I brought along a tape recorder, I never used it. Creating a climate of trust between me and my informants became imperative, especially as the threshold for getting into trouble with the authorities was generally lower for Sri Lankans than for Indians. Discussing sensitive issues related to the conflict, LTTE, or to corruption and surveillance had to be done in an atmosphere where insecurity was minimised and where people felt safe and at ease. They should have the understanding that the information which they conveyed to me should not be traceable, and having their statements on a tape recorder would not contribute to the establishment of such a climate. Collecting data was therefore done solely by writing down field notes in the presence of the person I spoke with, but sometimes also after I met people if this felt more appropriate – for instance to avoid interrupting a discussion or event. Sometimes people refused to give certain information or

even to tell me their name. People's statements were not written down on the occasions when they specifically asked me not to do so.

Insecurity and self-presentation

Insecurity and suspicion was frequently mediated in people's self-representation and life-histories. Life-histories creates continuity and give meaning to life courses which have been devastated by radical events or which are characterised by discontinuity (Knudsen 1990). Knudsen maintains that these should not be seen as either true or false, as their purpose are not to present people's lives as such. They are coping mechanisms and strategic constructions to establish continuity. The insecurity often felt among the Sri Lankans was regularly mediated through the presentation of such stories.

Certain features were recurrent in people's self-presentations and life-histories. People who had experienced both the armed conflict as well as the dramatic years leading up to it, frequently insisted on telling me the story of Sri Lanka and the oppression of the Tamils before they were willing to answer any of my questions. They said that it was of imperative importance that I should understand their suffering and the background of the conflict. Moreover, when they turned to tell about local events and of the brutality and violence they had witnessed, their stories had a tendency not to involve their participation. They were either not part of the stories or they dissociated themselves from the actual events, giving the impression that they had only observed the incidents from a distance and that they had not taken part in them in any way. What's more, the stories tended to end when they left Sri Lanka. Their experiences in India were seldom conveyed unless asked for explicitly by me. When this was done, problematic experiences, for instance with the Indian authorities were often avoided either subtly, but sometimes also explicitly, by stating that they did not want to answer my questions. This can be seen as a way of limiting insecurity in their surroundings, and to avoid attention on issues that was interpreted as a threat to their safety.

In relation to life-histories, Knudsen (1990) argues that people's representations and self presentations could vary from one situation to the next, and were often influenced by their personal history and by the way they comprehended their past. I find it fruitful to view Knudsen's notion of life-histories in relation to Katherine Ewing's (1990) concept of shifting selves. Her concept relate to people's different but equally important selves which often are

interpreted as inconsistencies from the outside. This, together with life-histories – as necessary strategic constructions employed to cope with everyday life, may shed light on reasons why some people are more open than others, and on why people are skeptical about passing on information in certain contexts and not in other. Suspicion towards one's environment may be produced when one's situation is comprehended on the basis of various disrupting experiences. But such an understanding does not necessarily persist as life-histories presented under certain circumstances may often diverge from self presentations presented in other contexts. Following Ewing's argument, while one context or circumstance could generate a specific understanding of self, this could be replaced by another different self which is based on a different understanding of one's situation.

FIELDWORK AND LOCALITY

Fieldwork as an anthropological method has been subject of scrutiny and critical evaluation for instance from postmodernist anthropologists. Fieldwork as a method for collecting data was institutionalised by Bronislaw Malinowski in the early 20th century, but had its foundation in naturalistic sciences. Besides having fieldwork as its distinct method, anthropology and natural sciences had “the detailed study of limited areas” as their objectives (Kuklich, cited in Gupta and Ferguson 1997:6). Societies were regarded as isolated from external influence, whereupon colonialism and conquest was actively ignored. This perception on society was consistent both with Malinowski's functionalism, which saw practices and customs as related to biological and cultural needs, and with structural functionalism – which gradually replaced the former – which regarded societies as organic wholes. As structural functionalism lost its prominent position in the discipline, there was a methodological improvement in anthropology with the incorporation of individuals, dynamics and social interactions (Holy 1984). It has been argued that conducting anthropological fieldwork in a limited area makes it difficult to incorporate trans-local or multi-local dynamics of influence. In this context, Arjun Appadurai and Carol A. Breckenridge (1988) argue that cultural forms are increasingly cosmopolitan which force us to revise the traditional concepts of culture which were designed for small-scale and stable societies. Raja Nagar should not and cannot be considered isolated from broader trans-national relations and dynamics, and these trans-national dynamics represent a significant methodical challenge.

Kottak and Colson argue that local communities are never isolated, and must be understood in much larger contexts. This argument is generally not contested. However, in order to accomplish this task, they maintain the advantages of a multilevel, multisite and multitime focus which would emphasise the existence of potential destabilising aspects emanating from a multilevel influence (Kottak and Colson 1994). They request longitudinal studies or comprehensive comparison between societies as a method. By focusing on the increasing complexity of today's societies and on the extensive ethnographic material which has been accumulated, the multilevel perspective will give a broader perspective on how local conditions are influenced and transformed by global dynamics. Methodologically, this implies a sort of "quantitative qualitativity", but as Kottak and Colson also note, it will inevitably represent a problem when aspiring to maintain a clear analytical perspective and to use all information effectively. Such a method was inevitably unfeasible for me. The question is thus, whether it is possible to conduct a fieldwork in a limited location, and also incorporate multi-local influence in anthropological analyses. According to Kottak and Colson, this is difficult.

Kapferer (2000) is critical to much of this critique, and argues that fieldwork and the concept of culture are central notions in anthropological research. Post-modern criticism on bounded communities, such as villages, as the sole locus of fieldwork is an attack on an imagined actuality of recent construction, he argues. Anthropology's focus on culture as a concept is central in his argument. He argues that the village is merely a place of residence, from which people constantly move to and fro, and from which the anthropologist move out along the lines of social relations. Following people in their daily life, while moving throughout the region is in fact multi-sited. While many Sri Lankans in fact moved between countries, and not only between villages and near environment, the impact of this movement was perceptible. This impact was material as well as "cultural", the latter in the sense of diverging perceptions on the world between people. In a material sense their persons did not even have to be in the specific locality to leave a strong imprint on people's lives, in spite of the fact that this influence is trans-national or multi-sited in character. My study which concerned the Sri Lankans who lived in Raja Nagar focus on their movements, but also the effects of their significant 'fellow-men' on their local lives. Also, Appadurai introduces the notion of *ethnoscapes*, which he describes as "the landscape of persons who make up the shifting world in which we live: tourists, immigrants, refugees, exiles, guest workers..." (Appadurai 1991:192). He sees this in connexion with the increasing importance of movement of people,

with the changing social, territorial and cultural reproduction of group identity. Much owing to the mass media, Appadurai argues that the idea and the possibility of movement earlier were limited to specific groups of people, while it today is open to more people. Considering the situation of the Sri Lankans in India, this is to a certain extent true. While the willingness of the Sri Lankans in India to move seems to have increased after 1991, the poorer Sri Lankans' possibilities for movement during the last decade have undoubtedly decreased. This is mainly due to stricter immigration rules in Europe, but partly also due to corruption in the Indian immigration system. Imagination is however a crucial point in Appadurai's argumentation. He argues that imagination as ethnography is important as it is not so definitely localising, and it encompasses people's aspirations.

CONDUCTING FIELDWORK

The method that I employed while conducting my fieldwork was that of participant observation. Participant observation involves a form of interaction, while it implies collection of data. Participation in people's activities makes it possible for the researcher to both observe interaction, and it facilitates different sorts of research techniques such as formal and informal interviews, collecting statistical data, photographing, filming etcetera. My research largely consisted in spending time with people when they went to the marketplace in Akhadipuram, when they visited friends and kin or attended weddings, when they stayed at home, working or relaxing after a long day of work and such. While I talked to people and asked questions, I sometimes only observed people's conductance and interactions. I also interviewed people, many whom I met only occasionally.

Long-lasting fieldwork

I regarded it as important to stay in the field for a certain amount of time to diminish certain methodological difficulties. The presence of an anthropologist evidently affects the situation observed (Holy 1984), but its impact may be reduced by a lengthy stay. One will get to know people better and maybe reduce people's scepticism. The latter was especially important in my case. One of the purposes for conducting a long fieldwork has traditionally been to obtain material which is as objective as possible (Holy 1984). Russell Bernard argues that objectivity does not mean that one should refrain from having biases, as absolute objectivism is unobtainable, but one should become aware of them and transcend them (Bernard 1994). There are also sets of aspects influencing the process of data collection and what data is made

available. The anthropologist will also always be positioned, politically, morally and academically in relation to issues she or he has chosen to investigate. An awareness of this is fundamental. The implicit limits that come with the anthropologist's own empirical and theoretical interests and predispositions – as these to a certain extent will guide her or his research and conductance in the field (Holy 1984) – may be reduced by conducting a long fieldwork. While I had certain preconceptions about the order of things in the field, my research foci developed and changed as time passed and as my knowledge of people's lives became more extensive. Also, the local cultural dynamics became more familiar, and I understood better the effects of my presence on people and their environment.

Access to information

In the beginning of my fieldwork, it was significant not to try to direct the issues that we discussed in specific directions. By letting people speak freely about their concerns, I got access to information that was important for them, and that I otherwise would have found hard to obtain or even to think of as relevant. People were generally concerned about the political realities in Sri Lanka, on which they wanted my opinion. The fact that I was Norwegian was a favourable factor in my rapport with people. At the time, Norway had started their role as a facilitator between the Sri Lankan Government and the LTTE, and my informants' faith and trust in Norway to help ending the armed conflict was strong. They frequently asked me about Norway's real motivations for getting involved in the conflict, but also the reasons why Norway sent back Tamil asylum seekers. This was an opportunity to present my knowledge and understanding of their situation in Sri Lanka. My experience was that political discussions facilitated my contact with people. Though discussions were beneficial in order to 'break the ice', it also presented me with some problematic aspects, such as neutrality and loyalty to my friends.

METHODOLOGICAL CHALLENGES: NEUTRALITY, LANGUAGE AND GENDER

Having a self-reflexive approach in the field was significant, not only because my presence obviously influenced the data that I obtained, but also as this influenced people's behaviour. The fact that I was a Westerner, a Norwegian, and an unmarried man influenced how my fieldwork developed, and how by people related to me.

Neutrality

Ideally, a fieldworker should aim to understand people's own realities, but also to perceive these from the outside. Remaining neutral and unbiased towards people and events in a context which is highly politicised and characterised by tension is difficult. Accounts about violence, fighting and loss in Sri Lanka, as well as of harassments and problems with the local population in India were recurrent. People had conflicting opinions about Sri Lankan politics in general, the LTTE, Indians and Indian authorities – which could easily make me predisposed to certain views. In such contexts I believe it was more important to be reflexive about my predispositions than attempting to remain neutral and to avoid taking a stance – This may be very difficult, but more importantly is to reflect on whether it is desirable to remain neutral in all politicised contexts? For instance, taking a stance against some of the corrupt dynamics and writing about them could have an effect in reducing them. Gledhill argues that anthropologists may under conditions that he is reflexive, take positions and get involved in political issues. This may produce knowledge which again can lead to concrete actions (Gledhill 1994). Reflexivity is crucial as the anthropologist's actions also can have far-reaching negative consequences. Remaining neutral or unbiased was as I saw it more important in other contexts, as for instance in situations where people spoke to me about their frustrations with family members that I also knew. I frequently experienced loyalty conflicts between people from different generations, usually between parents and children. On two occasions, father and daughter confided their frustration to me in issues related to marriage and love. It was important for me to try to understand their position, but also not to take a clear side, which was not always easy. Disputes between different families were also not uncommon, and I ended up between the devil and the deep blue sea on several occasions. "Luckily" – in such contexts at least, I did not speak Tamil which prevented me from getting involved when people argued in my presence. I usually got the parties versions of the disputes afterwards, to which I also tried to remain unbiased. I usually tried to tell people that their disputes were between them and that I had nothing against the other party.

Language and "gatekeepers"

A central obstacle during my research was my poor knowledge in Tamil, which prevented me from picking up everyday chatting on the roadside, at local shops, or at people's houses. Information obtained here could have been useful to understand informal local dynamics in a setting where people's interactions were less influenced by my presence. Many people in Raja

Nagar knew little or no English, and I was not able to speak to them without using a translator. On these occasions, friends such as Ambiga and Rajkumar helped interpreting. I initially tried to use a regular translator, an Indian whose father was from the Sri Lankan Hill Country, but people were sceptical to strangers or to people they did not know well. I therefore regarded it more beneficial to use mutual friends as translators, though their English was not always perfect. Using unknown people of different geographical origin as translator often proved to be problematic. On two separate occasions I experienced difficulties when a friend from Colombo was going to translate interviews with people from Jaffna. Both times they got scared when they learned that my friend was from Colombo and not from Jaffna, though he too was a Tamil. This greatly affected one of these interviews, where all personal questions were avoided. But it must be emphasised that using mutual friends as translators also influenced the data that I got. Some people clearly did not want their stories or opinions to be known to people in the neighbourhood. The presence of more people than the informant and me sometimes affected our communication. One Sri Lankan frequently took me to the side if there were other people around when he wanted to talk to me.

On the other hand, I would never have got access to many of my informants had it not been for Ambiga and Rajkumar and certain others, who sometimes acted as translators. Their role as ‘confidence-building middlemen’, or as sorts of “gatekeepers”, to use Hammersley and Atkinson’s (1987) notion, was no less than crucial. Gatekeepers are essential for getting access to particular domains, people and certain kinds of information which are otherwise difficult to access in research contexts (Hammersley and Atkinson 1987). I was a stranger and a foreigner asking personal and often sensitive questions to people who often had experienced persecution and harassment both in Sri Lanka and in India, and whose confidence in people did not come easy. Hammersley and Atkinson also maintain that gatekeepers not always are visible. People who suspected that I was somehow connected with the authorities sometimes changed their opinion by learning that I had had contact with OfERR. Though people’s rapport with and opinion about OfERR varied, the organisation represented the Sri Lankans in India, which made it easier to obtain a certain footing among people in Raja Nagar.

Another aspect that should be mentioned in this context is the information that I received from camp refugees. Due to limited access to the camps, my thesis has a limited focus on these Sri Lankans. I nevertheless spoke to some, mainly at OfERR offices but also in refugee camps. As few of these refugees spoke English, I needed translators, whom almost exclusively were from the organisation. As its political position and refugee policy is well defined, my impression was that it was difficult for the refugees to express themselves freely about various controversial issues. Hardly anyone expressed any criticism towards OfERR's work, or any views that diverged from OfERR's official policy or view on the practices in the camps. Such information was however revealed in situations where no OfERR-people were present.

“The mystical stranger”

Many people in Raja Nagar did not know the purpose of my stay, and speculated on the reason why I was there. During my stay, I never saw any Westerners in the area, though there was a Pentecostal mission station closer to the city. I tried to avoid too much attention on my research due to people's sense of insecurity, so I usually told people that I was studying Tamil, which also was an initial intention. I however gave this up for various reasons. Thus, it became more and more embarrassing for me when people did not detect any improvement in my Tamil. I usually excused myself by saying that I was too embarrassed to talk, but many insisted that I should try – which frequently turned out to be quite embarrassing on my part. I am sure that many people in the area did not think of me as the brightest person around due to my dreadful Tamil. Some people also believed that I was doing research.

As I spent much time with Ambiga and Rajkumar, rumours in the neighbourhood started to circulate. People said that I was buying all sorts of things to them, and that I was going to help them getting to Norway. These rumours were also spread by people who knew the purpose of my stay, but mostly by all their neighbours, who observed that the “foreign Tamil student” was spending much time at their house. For example, Ambiga told me that when they bought a motorbike some time after I left my fieldwork, everybody were convinced that it was me who had sent them the money to buy it. Many people in the neighbourhood, both people I knew and people that I had only met a couple of times, asked me if I could help them to get to Norway. I always answered that I had no possibility to do that, but many insisted and continued to ask. Karpan, one Sri Lankan who observed that I was close to

Ambiga and Rajkumar once asked Rajkumar if he could ask me if I could help Rajkumar to Norway. This was after having asked me several times for help to get abroad. Rajkumar did not instantly understand his question, and thought that Karpan wanted him to ask if I could help Karpan. When Rajkumar understood his question, he eventually told Karpan that he had no interest in going to Norway, and asked him why Karpan wanted him to ask me that question. He did not get a straight answer from him, but Rajkumar thought it was to check if I wanted to help them, but not him. Some people also asked me if I could help them to get abroad as they helped me with my research, as a sort of reciprocation. Fortunately, these kinds of questions seldom came from people that I spent much time with. The closer I got to people, the more difficult it was to explain that I was unable to help them.

Other difficult and related situations were when informants asked me for money or for help to acquire basic necessities. Many of my Sri Lankan and Indian friends were poor, and in many people's eyes, I represented someone with money. I also got the impression that some people wanted to become my friends only because I was a "rich foreigner", something that I was highly uncomfortable. I felt uneasy when people asked me for economic assistance, and I avoided doing so to the maximum extent. However, I occasionally helped some of my friends, but I was very concerned not to make my relationship with them based on economic dependency.

Women and gender issues

It was of primary importance to become accustomed to local norms in order to meet people on their terms, and to act in ways that would not be regarded as offensive. In the beginning of my stay, I was not familiar with people's expectancies from me and my behaviour, in light of my status as an unmarried man. But one day, after about one weeks stay in Jeyadhani's house, some of her relatives came for a visit. All, but one were women. I thought it would be polite to go outside to say hello, but as I came out, not only did they not smile, but they did not even look at me. They walked in and to the back of the house, as if I was not there. I went in and one of Jeyadhani's relatives, who arrived just before, sat alone in the living room. As I entered, she got up and left without a word. I went outside to the entryway of the house for a moment or two before going back in. The lady was back in the living room, but again she left, just as quietly as she had done the previous time. Another similar situation occurred at the house of another lady that I knew well. She was frequently visited by an Indian student

from rural Tamil Nadu. I had seen her several times, but we never spoke as the girl was extremely shy. One day the lady told me that the girl had commented something about me being in my fifties. The lady, who had been stunned by this comment as I was in my mid-twenties at the time, told me that the girl had been so bashful that she had not even dared to look at me. This happened in spite of the fact that we had been in the same room several times. Though the latter example was quite particular, common for the Indian girl and Jeyadhani's relative, was that they were both unmarried and from a rural background. Sheryl Daniel emphasise the existence of three conflicting positions regarding the relationship of men and women in Tamil society. The hierarchical "Chidambaram code" entails that the respectability of husband and wife emerge from a formalised mutually ranked interaction (Daniel 1980). Central features are male superiority and female submission, and that women get respect by virtue of being a wife. Marriage eliminates potential rumours of promiscuity. In Daniel's study, based on a fieldwork in a village close to Trichy in central Tamil Nadu, the legitimacy of the "Chidambaram code" was widely acclaimed. It was seen as a representation of status quo, of how things had always been. I could see a clear parallel to my research. I was told that unmarried Tamil men and women were not supposed to be alone in the same room, and in both situations described above, the women knew that I was unmarried.

Such values, tended to stand stronger in rural areas; this I observed on several occasions. I was frequently asked about my family and my marriage status when I met people. When younger unmarried women learned that I was still unmarried, they usually blushed, started giggling and became obviously embarrassed. For this reason, it was often a problem to become acquainted with younger women. There was however a clear difference between women from different areas. Many of my main informants were in fact young women, but mainly from urban areas such as Colombo and to a certain degree also Jaffna. Otherwise, or in addition, they had lived a long time in Akhadipuram or in other large Indian cities, and had become accustomed to an urban living.

There was however certain domains or situations that were strictly reserved for women and that I did not get access to as a man. However, Marianne, my girlfriend visited me for three months during my fieldwork. She became very close to some of my female informants, for instance a girl named Devani. This gave me a certain access to some of these domains. Devani, who was the daughter of Ramaswamy, one of my main informants, got married

during my fieldwork – which circumstances will be elaborated in chapter seven. During the preparations, we spent a lot of time with her, her younger sister and their friends. Devani felt very at ease with Marianne and spoke rather openly about many problematic matters related to her marriage. In addition, Devani often used us as a ‘mirror’ to express various sentiments. Some time after her marriage Devani, her sister Radha, Marianne and I went to a local juice shop, where my girlfriend ordered something else than me. Devani told us that if her husband would have been there, she would have ordered the same as him, no matter what she really wanted. She said that she felt it was her duty as a wife to do the same as him. My girlfriend sometimes also spent time with Ambiga while I was at home. On these occasions she could get information that I probably would not have got. Most of this information was not harmful to people, and served to shed light on gender conceptions as well as broader issues related to purity and caste.

With regard to respectability, I believed that it would pose a problem that Marianne and I were not married. This did not seem to be the case. I told local people who were not my informants that we were married, but most of my friends knew that we were not. I did however tell them that we planned to, but that we had not come that far yet.

ANONYMITY

Regarding the sensitivity prevailing in the environment where I conducted my fieldwork, it was imperative to take some precautions while writing. Concealing place names and people’s identities emerged as an ethical necessity. People’s occupations, the countries where their family live have frequently also been cached, and single persons have occasionally been split up and made into two different individuals in the text. This has been done if I considered it a possibility that a person may be recognised. Some of the information that I received about people was also second hand. Unless stated, I have tried not to use this information before I checked its “validity” from other sources.

Chapter 5 – Identity and local life

INTRODUCTION

Having established features of Sri Lankan settlement in Tamil Nadu and various challenges related to the conductance of my fieldwork and the collection of data, I will now move to the research itself. I will start with a focus on the Sri Lankans in their locality, and with local dynamics, experiences and identity constructions. This involves an exploration of the relationship between the Sri Lankan immigrant population and the local Tamil inhabitants in Raja Nagar. The relationship between the Sri Lankan exile population and the Indian host community should be understood within a mutual framework of local processes and framework, and in terms of the consequences of the assassination of Rajiv Gandhi.



Raja Nagar

Before engaging in a discussion on local formations that relate to identity negotiations and the relationship between Indians and Sri Lankans, the impact of the assassination of Rajiv Gandhi should once again be outlined. A comprehensive analysis of this event and its consequences will however be assessed in chapter eight, but certain aspects should be emphasised here as they represent a crucial framework for how the Sri Lankans' situation in

India and their relationship to the host population should be understood. As emphasised in the introduction, the assassination was a defining moment for the Sri Lankans in India as they largely came to be categorised as a community of ‘potential terrorists’ following this event. The severe restrictions affecting the Sri Lankans in India after 1991, such as the ban on education, NGOs being restricted to work with Sri Lankan refugees, and the widespread arrest and compulsory registration of Sri Lankans, were more tangible manifestations of the changed status of this community. However, as noted in the introduction and also in chapter four, when addressing the aspect of fear as a challenging aspect of my research, panopticism and formations of disciplination emerged as a decisive factor for identity formations and practices. The general behaviour of many Sri Lankans was structured by the existence of, as well as fear of, repressing structures and not necessarily by having experienced these. Notions related to the LTTE were looked upon with great suspicion and largely considered illegitimate within a national discursive framework, a notion I will address more extensively in chapter eight. The reduced status of the Sri Lankans and their demonisation had made them liable targets of extortion from corrupt officials. The fear of such dynamics and the experience of having a low status in the Indian society with few rights thus disciplined and restricted their behaviour. This, as we shall see, was very significant in shaping the relationships between Sri Lankans and Indians in Raja Nagar.

While these discursive formations penetrated and permeated social life in localities such as Raja Nagar, people also emphasised local experiences as fundamental for the nature of the relationship between Indians and Sri Lankans. These local dynamics more directly influenced conceptions and prejudices against what was conceived as “the other”. While keeping in mind the repressive and disciplining effects of the assassination as an underlying factor for people’s comportment and behaviour, people’s preconceptions and the construction and negotiation of identities between Indians and Sri Lankans and within the Sri Lankan community will be addressed more extensively. I will also direct my attention to the way in which the Sri Lankans encounter and construe the Indian state seen in the light of the assassination, as this has largely defined their understanding of India.

SOCIAL LIFE AND IDENTITIES IN RAJA NAGAR

I will start by presenting various theoretical approaches to identity, and also emphasise the importance of looking at people’s own understandings of their reality. I will then describe

some significant local conceptions which have influenced the relationship between Indians and Sri Lankans in Raja Nagar. It will be crucial to identify the relationship between people, the identities that people operate with, and how negotiations of these identities are performed. By doing this, I wish to accentuate the complexity of local life in Raja Nagar, and also that the Sri Lankans don't perceive themselves as a homogenous group. This relates primarily to aspects such as caste and place of origin, but elements such as experiences also have an impact on these conceptions. People's categorisations appear in certain circumstances to be strategic, while in other situations unconscious, as if possessing a *doxic*⁶⁰ immediacy and discursive-like quality.

THE NEGOTIATION OF IDENTITIES

Richard Jenkins (1996) characterises identity as a human feature that makes us social beings, and stresses that identity therefore always is social. He argues that identity constructions represent an active process of creating meaning by categorising and classifying things or people, and further to associate oneself with something or somebody. It is a systematic establishment of significance between individuals and between individuals and collectivities; it is a way of ordering the world. Social identity is our understanding of who we are, and who others are. Jenkins further maintains that individual and collective identity is similar and intimately related, and that the processes in which they are produced, reproduced or altered are analogous. Both identities are social, but while individual identity emphasises difference, the collective highlights similarity. He maintains that social identities seen as isolated from embodiment are unimaginable and that certain of our identities have their origin in our earliest socialisation, for example, gender, self-hood, human-ness and sometimes kinship. The body is itself a referent of individual continuity and an index of collective similitude and differentiation (Jenkins 1996:21). Identities can be chosen, but sometimes also forced upon by others. Identity is always in flux, negotiated between processes of self-ascription and attribution, and its amplitude may vary in accordance with dimensions of time and space. As Liisa Malkki contends, "identity is always mobile and processual, partly self-construction, partly categorisation by others, partly a condition, a status, a label, a weapon, a shield, a fund

⁶⁰ Bourdieu uses *doxa* to describe a state where there is a "quasi-perfect" relation between the objective order and the subjective principles of organisation. It is a context where the natural and social world appears as self-evident. He further opposes *doxa* to *orthodoxy* or *heterodoxy* which implies an awareness and recognition of the possibility of different antagonistic beliefs (Bourdieu 1990:160).

of memories, et cetera. It is a creolized aggregate composed through bricolage” (Malkki 1992:37).

Fredrik Barth (1969) argues that the negotiation of identity performed at the ‘boundaries’ between groups represents the critical dynamic of ethnic formation. It is in other words not the ‘cultural content’ *per se* which is used to legitimate ethnic categorisation or bounded collectiveness. He further distinguishes nominal identity which is the name of an ethnic group, from virtual identity, which he describes as the various experiences of an identity, or what it means to bear an identity. Jenkins’ (1996) view on ethnicity is largely an extension of Barth’s perspectives. But Jenkins is more concerned with external categorisation and its dimensions of power in the process of identity construction than with the internal ascription which is central to Barth’s argumentation. He argues that power, often inherent in external categorisations, may strengthen a community’s group identity. We will see this in the context of Rajiv Gandhi’s death, where the Sri Lankans’ experience of being demonised and alienated appears to have fortified a seclusion from the host community. This encompasses an aspect of power which is largely absent in Barth’s theorisation. The power perceived by the significant actors affects the relational power balance by means of a process of disciplinatio which produces and reproduces an awareness of inequality at the boundaries where ethnic identity is negotiated. Self-ascribing specific cultural traits does also not automatically give people an ethnic identity, unless one presupposes that the group of people to whom the traits are attributed is an ethnic group (Roosens 1994). Eugeen Roosens agrees with Barth’s boundary concept, but maintains that some dimensions of ethnic identity are both logically and ontologically prior to any form of boundaries between ‘us’ and ‘them’. Boundaries in themselves do not constitute identity, they can only express, add to or play down an already existing ethnic identity. He seeks a combination of a focus on boundaries and the metaphor of origin which includes a notion of self-definition. The latter includes a popular genealogy, but not as an essential human trait. It is constitutive for the group, but is not ethnic exclusive. Hence, it is essential to consider identity formations and negotiations at the boundaries between groups, as it is here that conceptions on the other largely are conceived. However, cultural formations and diversity produced by distinct historical and societal processes should in this context not be neglected. Such formations have shaped people’s experiences and modes of behaviour, which emerge as significant for how people construe themselves and negotiate their practices in an Indian locality.

THE LIFE-WORLD

The reality in which people as intersubjective beings act in and upon must be taken into consideration when relating to significant local conceptions, the relationship between different groups and the various forms of local identity negotiations performed by people in Raja Nagar. By means of a phenomenological approach, as propagated by Alfred Schutz (1970), social action will be addressed and interpreted, and the cognitive reality embodied in subjective human experience will be taken into account. While people have highly distinct subjective experiences, the interactive environment wherein people engage socially is shared with others through common apperceived objects and events. Schutz maintains that all human experiences are experiences in and of what he names their 'life-world'. In Helmut Wagner's introduction to Schutz's book, he describes life-world as "...the whole sphere of everyday experiences, orientations, and actions through which individuals pursue their interests and affairs by manipulating objects, dealing with people, conceiving plans, and carrying them out" (Wagner 1970:14-15). People constitute their life-world, they are oriented towards it and they are tested in it. The life-world is fundamentally intersubjective, that is, fundamentally social and interactive. Wagner contends that intersubjectivity should be treated as "a 'fundamental ontological category of human existence,' a precondition of all immediate human experience in the life-world, to be accepted as something which is unquestionably given with the apperception of other individuals in their physical appearance" (Wagner 1970:31)⁶¹. This intersubjective reality should be seen as the 'natural attitude' which people have to their environment and to their 'fellow-men'. Fellow-men are presented as persons within our direct experience, present, past or potential, whom we have, have had or will have face-to-face interchanges (Wagner 1970:37). But it also includes 'contemporaries' who we coexist with, but whom we don't have any direct relationship with, and can thus include people described to us by others, or who are presumed by us. The presence of fellow-men in the world is conceived as equally natural as the surrounding nature for the person in question.

The world of our daily life is given to us, to our experience and interpretation by our predecessors through our socialisation into the institutionalised world (Schutz 1970). The life-world thus represents an interplay between this cognitive prestructuring of the world and the individual's efforts to comprehend the world around him. Hence, as the life-world

⁶¹ Wagner's quotation is from Schutz's essay "The Problem of Transcendental Intersubjectivity on Husserl" Collected Papers III:82.

comprises the totality of our experiences, orientations and actions, it cannot be seen apart from processes of identity constructions, from where we construe an understanding of who we are in the world. A person orients himself in his life-world by means of his 'store of experiences' and his 'stock of knowledge at hand', i.e., a person cannot make any decisions without consulting his own stock of knowledge. A person is at any specific moment what Schutz calls a 'biographically determined situation', which relate to one's physical and sociocultural environment as defined by the person in question (Schutz 1970:73). In this environment, the person has his specific moral and ideological position, but also a role within the social system. A situation being defined as biographically determined implies a personal historical dimension. One's conceptions are based on personal experiences and interpretations and are thus not shared by anyone else. A person's interpretation is a representation of the sedimentation of all of a person's previous experiences which are integrated in his stock of knowledge. This eventually becomes his unique and personal possessions and will function as a scheme of reference and produce certain possibilities of actions.

By approaching people's individual experiences and personal orientations intersubjectively, as argued by Schutz, one will account for their fellow-men and the dominant discursive formations, factors which have an effect on their situatedness in the world and on their consequent actions. The relation to their fellow-men may, when considering Jenkins' (1996) notion of external categorisation, involve a dimension of power which is of crucial importance in the context of the Sri Lankans in India. Schutz is preoccupied with the relationship between different groups. He argues that a person seeking to be accepted in a new group will find himself outside the current scheme of orientation that dominates in this group. He will lack any status, and in order to get accepted, he has to try to adapt his system of relevance to the one predominant in the new group. The way in which members of a group approach the world includes stereotyped ideas about how the world is interpreted by people representing another group, as well as interpreted notions of how this other group perceive their group. But Schutz maintains that they seldom seek a reaction or response to their ideas of the 'foreign' groups. While they serve as schemes for interpreting the other group, they do not function as a guide for the interaction between them. As Schutz argues: "...the scheme of interpretation refers to the members of the foreign group merely as objects of this interpretation, but not beyond it, as addressees of possible acts emanating from the

outcome of the interpretive procedure and not as subjects of anticipated reactions towards those acts” (Schutz 1970:89). These dynamics may result in a lack of understanding and reproduce various conflicting attitudes and approaches between groups, in this context, primarily between Indians and Sri Lankans. This dimension should be seen in relation to the interpretations of significant events. Interpretations of events may influence the perception of the other and structure their relationship. It is by means of actions in the world, i.e. for instance interpretations of events and in negotiations with their fellow-men, that meaning is generated and that identity is negotiated. Events are empty of meanings before they are interpreted, which always is conducted within the context of a person’s intersubjective apperception. For instance when certain Sri Lankans, following Rajiv Gandhi’s assassination construed their reality as laden with suspiciousness, fear and mistrust, in a context where they both undergo and exercise repressive power structures and thus reproduce them (see Foucault 1980, 1999b), this interpretation gives meaning to the event which again generates specific ways of acting in their interpreted world. Such interpretations, as actions upon the world, produce and reproduce people’s situatedness, or following Appadurai (1995), ‘locality’, as a relational and contextual phenomenological dimension of social life. People’s self-ascriptions, categorisations, or to be precise, their identity constructions, emerge within the framework of their life-worlds, but these interpretations are also a way of acting and producing meaning in the world. As Schutz argues, we work and operate both within and upon the world (Schutz 1970:73).

CATEGORISATIONS, NEGOTIATIONS AND MANAGING IDENTITIES

The way in which identities were presented and negotiated largely reflects the nature of the relationship between people. In this context, the prevalent complex identity negotiations between the Sri Lankans and Indians will be elaborated by presenting people’s conceptions which largely are seen as given, the internally perceived diversity within a categorised group, the processes of negotiating various identities, but also how people manipulate or obscure specific unwanted identities. This variety of focuses will give a more comprehensive understanding of the dynamics and relationship between the Sri Lankans and Indians in a locality like Raja Nagar.

Nationality was perhaps the most evident notion of demarcation between people in Raja Nagar. The relationship between Indian and Sri Lankans can best be described as limited,

even when they were neighbours. They rarely engaged socially unless they had to. The assassination's detrimental impact on the status of the Sri Lankans disciplined and curtailed the Sri Lankans' behaviour. This effect, their fear and consequent reclusiveness, enforced a segregation between the two populations which I also believe have strengthened the Sri Lankans' notion of a common national Tamil identity. However, the social dynamics and the nature of the relationships between Indians and Sri Lankans in Raja Nagar, as well as how stereotypes were negotiated should be seen in relation to people's life-worlds, to former experiences and to interpretations of local incidents. Local events in the present were ultimately what people related to, and what affected their everyday life. However, I also stress the existence of perceived and experienced cultural differences between Indians and Sri Lankans in Raja Nagar, but also differences created by historical and societal differences, as also outlined in chapter two.

I will begin by presenting existent preconceptions and stereotypes, first among Sri Lankans and Indians, then internally among Sri Lankans in Raja Nagar – and thus argue that Sri Lankans are not a homogeneous group, and finally – by means of empirical examples – I will question the persistence of some of these external categorisations. I will later turn to the dimension of experiences, former and present, which were fundamental in negotiating and producing these ideas.

NATIONALITY AND ETHNIC STEREOTYPES

The existent preconceptions between Indians and Sri Lankans in Raja Nagar were generally understood to be given and primordial, and do first and foremost reflect external processes of categorisations among these people. As we shall see later in this chapter, these ideas were generally created and reproduced through interpreting experiences and by stories told by friends and neighbours. The conceptions between Sri Lankans and Indians in Raja Nagar, which involved a great deal of suspicion, were fairly strong. Situations confirming the stereotypes were regularly seen as proofs of these preconceptions, while occurrences dismissing them only were seen as the exceptions that confirmed the rule. One should also consider various constitutive and formative societal formations appropriated through socialisation which were internalised and embodied. This knowledge would represent a fundamental framework for people's comportment and way of acting in the world, and thus

could configure differences and represent a mode of demarcation between the Sri Lankan and Indian populations.

Sri Lankan perceptions on Indians

Some of the most common notions about Indians held by Sri Lankans were that they were selfish, lazy, greedy for money and dishonest. Many people blamed India for being corrupt. This must be seen in relation to the fact that corruption surfaced as a significant problem for many Sri Lankans after Rajiv Gandhi's death. Sri Lankans frequently claimed that India was old-fashioned, and a place where caste and traditionalist gender roles remained too important. Indians were also blamed for being ignorant and insensitive about the sufferings of the Sri Lankan Tamils on the island. Some stressed that many Indian Tamils did not even know who Prabhakaran was. The majority regarded politics in India a shady business, something Garnet, a Sri Lankan from the Hill Country, stressed sarcastically: "*There are no requirements to be a politician in Tamil Nadu. You only have to be a mafia leader*". It should nevertheless be maintained that many Sri Lankans were positive to Indians, though they were fewer among my informants. Such an attitude also appeared to be more frequent among Sri Lankans who lived in areas with a smaller Sri Lankan population. Ramaswamy had lived in central Akhadipuram since he fled Colombo after the riots in 1983, and was one of my main informants. He said for instance: "*At present, so many people are helping. Everybody knows I am a Sri Lankan. [...] We all come from the Tamil Community*". Ramanujan was a Vellala whose family originally came from Jaffna but who had grown up in Malaysia where his father had a position within the colonial bureaucracy. He also emphasised the decency of Indians though he maintained their preoccupation with money: "*It was a terrible blunder by the LTTE to kill Rajiv Gandhi. India is such a tolerant country, a wonderful country. Nobody asked me "Why did you kill Rajiv Gandhi?" They are such tolerant people [...] There is only one problem with the Indian man, he is crazy about money. [With] the Sri Lankan dowry, you pay and walk off. The Indian fellow is a plunderer*".

Many Sri Lankans complained about the way the Tamil language was spoken and written in India, and *Madrasi Tamil*⁶² was considered particularly corrupted. Murugan, a former militant from northern Jaffna for instance emphasised this: "*They (Indian Tamils) are forgetting the Tamil,*

⁶² There are a cluster of different Tamil dialects in India, for instance from Madras, Madurai, Tirunelveli, and Coimbatore. Dialects are sometimes also linked to caste, such as Brahmin, Chettiar and Kongu Tamil. Madrasi Tamil have also been under influence by English, and have incorporated many words in its spoken language. This is for instance evident when watching Tamil movies.

*not speaking properly. They use ten English word and one Tamil word*⁶³. The Tamil spoken in Sri Lanka and especially in Jaffna was regarded as ‘pure’, spoken beautifully with the correct intonation and with the required refinement and grace⁶³. Indian Tamil was not only regarded as corrupted by the English language, but also by Sanskrit (see also Hoole 1997, Wilson 2000). Language was a strong point of identification both in the Indian Tamil nationalist movement, as well as in Sri Lankan Tamil nationalism. In Tamil Nadu, there has for instance been a long struggle to get Tamil recognised as a classical language along with Latin, Greek, Sanskrit, Persian and Chinese (see e.g. Viswanathan 2004). Language was promoted as a critical feature of Tamil culture and identity in Sri Lanka, and was used to counter the growing Sinhalese chauvinism during the last decades. Wilson argues that Tamil literature and theatres also were used as locations and contexts of acts of resistance against the repressive Sri Lankan state (Wilson 2000). When Sri Lankans in India promoted superiority in language, they simultaneously emphasised a cultural pre-eminence which many Indians reacted against.

Indian perceptions on Sri Lankans

A general perception among Indians on Sri Lankans was that they were withdrawn, secretive, arrogant and cunning. The existence of similar external characteristics, from Sinhalese, Sri Lankan Muslims⁶⁴ and Indians have also been presented by Daniel (1996), Rødseth (1999) and Wilson (2000). Many Indians believed that Sri Lankans were involved in illegal and dubious activities which they tried to conceal from the public. This was underscored by the many Sri Lankans’ frequent reclusive behaviour.

Chandran, one of my closest Indian friends, said to me that Sri Lankans and Indians were different and that Sri Lankans in general were more “*bold*” than Indians. He said that they generally had more life-experience than Indians, as many had undergone traumatic experiences which had matured them. He also believed that Sri Lankans were more liberated and emancipated than Indians. While Chandran did not express disapproval of this, other Indians stressed that especially Sri Lankan women were too emancipated in the way they dressed and behaved towards men. I was on several occasions warned against Sri Lankan girls

⁶³ For example, the formal ‘you’ (*Neengal*) was used on equal terms when addressing adults and children in Jaffna, while the informal ‘you’ (*Nee*) was applied for children in India (see e.g. Hoole 1997). Many of my Indian informants found it very amusing that children were spoken to in such a respectful manner.

⁶⁴ The Sri Lankan Muslims or Moors are considered as a separate ethnic group in Sri Lanka. This population is almost exclusively Tamil-speaking.

by Indian friends. Some also emphasised LTTE's use of female suicide bombers as an unhealthy quality of Sri Lankan Tamil society. Ambiga told me that Indian boys in the neighbourhood made jokes about Sri Lankan girls, saying that one had to watch out if you went out with them because they were carrying bombs under their sarees. Sri Lankans were nevertheless almost without exceptions portrayed as hard-working, proud, strong-minded and resolute. Many Indians also emphasised a resemblance between Sri Lankan Tamils (primarily Jaffna Tamils) and *Malayalees* – people from Kerala, who were seen to share many of the same strong but nevertheless 'treacherous' qualities.

The majority of the Indians emphasised that there had been problems with the Sri Lankans since they came and wanted them to return to the island. Some stressed that there were enough poor and suffering people in India, so why should they take in more? But like with the Sri Lankans, not all Indians in Raja Nagar were negative towards the Sri Lankans. Some regarded them as their victimised kin and stressed that they needed protection. Others agreed on that point, but nevertheless pointed out that there were lots of problems with the Sri Lankans now. Killing Rajiv Gandhi was a disgraceful act, but only one of the many problematic features of the Sri Lankans in India. People expressing such opinions would usually state that it was wrong to send them back now due to the conflict, but hoped for a solution so they could eventually return.

The following examples presents social encounters between Indians and a Sri Lankans, and illustrate some of the feelings people from the two countries could have for each other.

While I stayed in Jeyadhani's house in the beginning of my stay, Deva and Venkadesh, two Indian friends came to visit me. I went out to meet them at the gate and asked if they wanted to come inside, but they declined. While we stood outside talking, one of Jeyadhani's sons also came out and asked if they didn't want to come inside. They declined anew and said that they were about to go. As soon as he went in, Deva whispered to me, "*Never trust a Sri Lankan, I don't like these people*". The son commented afterwards that they thought it was strange that Deva and Venkadesh did not want to come inside the house.

One day I went to visit an Indian lady I knew together with a friend of Sri Lankan Vellala origin but who had grown up and lived his whole life in Europe. She had on several occasions expressed grievances towards Sri Lankans, for instance for what she saw as their continuous complaining about India: "*If they don't like it here, why are they here, then?*" she said to me on one occasion. She also complained about the LTTE and their assassination of Rajiv Gandhi, as well as the poor treatment of the Indian

labourers by the Jaffna Tamils when they came to Sri Lanka for work in the 19th century. Initially, they spoke in a very friendly tone. Due to my friend's poor Tamil they spoke in English; she could therefore not distinguish his origin. However, at one point she realised his Jaffna origin and said: "*Oh my God, I thought you were Indian*". He said that, no, he was a Sri Lankan. She then said, "*Tell me one thing. Why do you (Jaffna Tamils) always consider yourself to be the cat's whiskers?*" He burst into laughter, but said that he thought that Indians were the ones who always considered themselves superior of others. She, of course disagreed, and the discussion continued for a while, but nevertheless in a friendly tone.

Cultural diversity and embodied knowledge

When bearing in mind the stereotypes that exist between Sri Lankans and Indians, it is also important to look beyond their mere formulations and try to locate more tangible formations which may be important to understand these conceptions. Certain societal formations and cultural norms will eventually be embodied and thus have a decisive effect on people's constitutive conceptions and behaviour. As these differences are played out in people's daily interaction, the understanding of differences between people from the two communities will be more evident. The following societal formation, I should add, is generalised and do not account for the internal complexity relating to caste, class, geographical origin, gender, experiences, etcetera. But I believe they still are of vital importance for understanding certain significant differences between Indians and Sri Lankans in a place like Raja Nagar.

First of all, differences should be seen in relation to the extensive colonial discursive transformation, or to use Daniel's (1996) notion, the "Europeanization" of the Sri Lankan society, compared to the less comprehensive colonial impact in India (see e.g. Daniel 1996:48). Sri Lanka is smaller, ethnically less complex, and has generally been a wealthier country than India. The Sri Lankans have thus fled from a poor country to a poorer one (Bastiampillai 1996, Suryanarayan and Sudarsen 2000). The numerical and traditional⁶⁵ political dominance of the Vellala caste in Tamil Sri Lanka (see e.g. Banks 1960, Dumont 1980) diverges from India with the minority Brahmin population's political and religious supremacy. The lack of a significant Brahmin population on the island has led to a less rigid caste-system within the Sri Lankan Tamil society. Tamil Sri Lanka also never underwent societal transformations similar to the non-Brahmin movement in today's Tamil Nadu (Béteille 1997, Subramanian 1999), an aspect I have dealt with in details in chapter two.

⁶⁵ I term this 'traditional' as the political hegemony of the Vellalas largely has been replaced by the Karaiyars due to their strong link to the LTTE.

Resistance against the established social system has been strenuous and revolts were largely stifled at their birth (Cheran 2001, Pfaffenberger 1994, Shanmugathan 1997). Aspects relating to caste will be approached in further detail later in this chapter. Another crucial factor is of course the armed conflict that Sri Lanka has undergone for the last 20 years. Its effect on the society and its population has been devastating. A societal feature which largely has emanated as a result of the conflict is a rise in migration and the establishment of large migrant networks abroad. Sri Lankans, especially families from Jaffna, frequently had relatives spread all over the world following the conflict. As we will see in the following chapter, these family networks and the remittances from these networks often had a substantial influence on the economic and material situation of the Sri Lankans remaining in Sri Lanka or for those living in India. These networks could also affect people's value systems, as weakening the importance of caste in daily practices, and strengthening what Fuglerud (1997, 1999) calls 'revolutionary values'. This has for instance been a feature of the Tamil community in Norway. Such a value system derives from the LTTE ideology and cosmology and accentuates a non-caste and non-class society structure with relative equality between men and women, and can be contrasted to so-called 'traditional' caste and gender based values.

These aspects refer to people's experiences, class, caste, place of origin, migration etcetera on a more structural level, and produce dispositions which may generate and structure practices. But these societal formations may also be significant and formative for local identity negotiations. Roosens (1994) maintains that in order to be fully accepted as a member of the community of origin in an immigrant setting, people have to respect certain specific norms which are considered basic. These traits, he argues are not created (though they are mediated) in interaction with the majority community. They refer to the country of origin and to dynamics and networks within this migrant community. This argumentation is comparable to that of Alfred Schutz (1970) when he maintains that people from the outside have to alter and adapt their system of relevance to that of the dominant group in order to be accepted and to resist censure. In any case, the specific norms which Roosens (1994) refers to are important means to generate a 'we' in relation to the host community. But to avoid reducing cultural traits to something primordial and given, Roosens maintains, as I also endeavour to do in this chapter, that such cultural groups are continuously changing and represented by internal differences, and also that internal cultural expressions do not always harmonise. With reference to cultural formations, I also see the benefits of tracing practices in what Bourdieu

(1977) names *habitus*. This notion is concerned with embodied traits, origin, class and experiences. It can be described as a set of generative structural schemes that produces practices and representations without reference to external sets of rules, which are goal directed without requiring a conscious selection of goals (Bourdieu 1977). These are embodied dispositions for actions, which influence how each and every one of us act and engage in the world. Bourdieu does not speak of individual “consciousnesses”. Instead, people from the same class, who share the same experiences or background may share a set of cultural values and ideas and sense a mutual association and identification. This may for instance explain why certain practices are taken for granted, but should nonetheless not be seen as an all-encompassing determinant for people’s actions. The above-mentioned societal formations, the armed conflict, formations relating to caste, class and place of origin represent significant differences between Tamils of the two countries, and, as we shall see, also between people from different places in Sri Lanka. People are influenced by their socialisation and the circumstances and locality in which they have grown up. These habituated and embodied notions are significant for their further comprehensions, interpretations and actions. Similar backgrounds and certain cultural norms understood to be basic and continuous within a group, though without necessarily being exclusive towards others, are as Roosens (1994) have pointed out prior to boundary constructions. Boundary constructions do not in themselves constitute identities, but may be used to emphasise, respond to and reproduce differences. Roosens deals with the process in which the ‘us’ as opposed to the ‘them’ becomes an ‘ethnic we’. The ‘us’ was never simple, he argues, as it already was ethnic from the inside. The ‘us’ emerges when common origin and a general ‘other’ is identified.

INTERNAL CATEGORISATION AND VARIATION AMONG SRI LANKANS

The Sri Lankan population in Raja Nagar was very diverse, not only in terms of geographical origin and caste-status, but also in the way they perceived their situation in India and how they regarded the local Indian population. There were also strong internal preconceptions among Sri Lankans on other Sri Lankans from different castes and of different origin.

Colombo Tamils, Upcountry Tamils and Jaffna Tamils

Sri Lankans’ view of India generally varied according to their place of origin. As we have seen, most Sri Lankans in Raja Nagar did not like India particularly well, but such an attitude

was however far more recurrent among Tamils from Jaffna and northern Sri Lanka, than among people from Colombo, the Hill Country and from Eastern Sri Lanka. Jaffna Tamils experienced more harassment from Indian officials and from the Q-branch than other Sri Lankans after the assassination of Rajiv Gandhi. Their likelihood of having LTTE links were greater than among other Sri Lankans, but they were often affluent due to having relatives in the West from whom they received remittances. Their negative attitudes towards India were also due to traumatic experiences with the IPKF. The Indian troops were guilty of extensive atrocities against civilians in northern Sri Lanka during their peacekeeping operation, something many people remember with great anguish and still blame India for. One lady from northern Jaffna, who lost several family members to IPKF-bullets and who generally expressed a strong dislike towards India and Tamil Nadu in general, went to the extent of saying “*Tamil Nadu people, bad people. When we go back, I hope Tamil Nadu [will be] destroyed by earthquake*”. This was in January 2001, only 19 days after the devastating earthquake that killed more than 20,000 people and affected more than 15 million people in Gujarat.

Also, many Colombo Tamils and Upcountry Tamils emphasised difference between themselves and Jaffna Tamils (see also Daniel 1996, Suryanarayan and Sudarsen 2000). Several of my main informants from Colombo also had their origins from the Hill Country, as Ramaswamy and Sivanesan. They both came to India after the riots in Colombo in 1983, from which they both barely escaped. My informants from Colombo often spoke of Jaffna Tamils as culturally conservative, caste-conscious and politically and socially excluding towards other Tamils. This was primarily with reference to the high caste Vellalas. Like many Indian Tamils, they also emphasised this community’s historical ill treatment of Tamils of Indian origin. Note that Sivanesan’s use of the term “*Indian Tamils*” in the following quotation refers to Upcountry Tamils of Indian origin and not to Indian Tamils *per se*.

“There is a big difference between Jaffna Tamils and Indian Tamils. They don’t like each other. Now there are lots of differences. The Jaffna Tamils treat the Indian Tamils very low, just like Hitler did with the Jews. They (Jaffna Tamils) think they should rule the world. They treat the Indian Tamils very cheaply. In the [refugee] camps, the Jaffna Tamils speak against the Indian Tamils. The camp people don’t support the Indian Tamils. Jaffna Tamils only support other Jaffna Tamils not Indian Tamils. They say I am Sri Lankan, you are Indian [...] In every respect they (Jaffna Tamils) don’t like them (Indian Tamils) [...] In Sri Lanka, because of Jaffna Tamils, the Indian Tamils are affected. They don’t want a separate country. They have no education; they don’t understand the real issue involved. Indian Tamils are most victims. [...] The problems started in

1914 with the Sinhalese – Muslim riots. The Tamils supported the Sinhalese. The Jaffna Tamils dug a grave for the Indian Tamils in 1952[sic]⁶⁶, now they are themselves in the grave’.

Ramaswamy, also of Upcountry origin, said:

“...Indian Tamils came to Sri Lanka with boat for employment. Jaffna Tamils saw them as illegal immigrants in Sri Lanka. They arrest them, put them in jail, and send them back to India [...] Sri Lankans arrested illegal Indians in Sri Lanka; even children. If there are three Sinhalese officers and three Tamil officers, the Tamil policemen will kick away the food they eat and arrest people even if there are children there. The Sinhalese will give them food and treat them nice’.

The majority of the Jaffna Tamils did regard the Upcountry Tamils as fellow Tamil victims of Sinhalese suppression, and they usually also admitted that the Upcountry Tamils had been treated unjustly after independence by Tamil MPs. Jaffna Tamils also stressed that all Sri Lankan Tamils, whether their origin were from the north, the east, from Colombo or from the Hill Country shared a history of suffering. The Upcountry Tamils, on their hand, usually disassociated themselves from the liberation-struggle of the LTTE, and instead blamed the Jaffna Tamils for making them victims of a conflict which they did not consider themselves to be part of. They saw their origin to be from India and not from the island of Sri Lanka, and did therefore not share the Jaffna Tamils’ perception of a “traditional Tamil homeland” in the north-east. On the other hand, most of my informants stressed that the nature, or the “essence” if you will, of the Indian Tamil immigrant workers changed after living in Sri Lanka a long time. They did no longer occupy the qualities and features of Indian Tamils. Their ‘*ur*’, described by Daniel as a territory not physically bounded, but nevertheless “a named territory that is (1) inhabited by human beings who are believed to share in the substance of the soil of that territory, and (2) a territory to which a Tamil cognitively orients himself at any given time” (Daniel 1984:63), was no longer in India but in Sri Lanka. People continuously affect and are affected by their relation to their *ur*. As this shared substance is absorbed by people they also develop particular qualities. In this sense, a person’s *ur* is central to one’s self-definition but also to one’s conception of belonging.

The attitude towards Sinhalese also differed in accordance with geographical origin, as seen by Ramaswamy’s statement above. He spoke of Sinhalese in a more favourable manner than Jaffna Tamils. This is noteworthy, as he was lucky to escape Sinhalese mobs who came to kill him during the 1983 riots. And he was by no means the only Colombo Tamil who did so.

⁶⁶ Sivanesan refers to the ‘Ceylon Citizenship Act of 1948’. The year ‘1952’ is retained in the text, for preserving the genuineness of his quotation.

Such a stance, I believe, is supported by the fact that most Tamils from Colombo had Sinhalese friends while living in the capital, while the native Sinhalese population in Jaffna was very scarce⁶⁷. The experiences that Jaffna Tamils had with Sinhalese were largely with the armed forces, which again shaped their general attitude towards them. A significant number of the Tamils from the north said that they could never live with the Sinhalese again; a separate Tamil Eelam was the only solution to the conflict, a view not often shared by Tamils from Colombo or from the Hill Country. The difference in attitude between Colombo and Jaffna Tamils was well illustrated by an incident in Raja Nagar:

I was invited to Suthalingam's shop-opening ceremony. As briefly presented in chapter six, he opened a shop in the neighbourhood with the help of remittances from his children abroad. After the required rituals and *puja*, everybody was invited to lunch at the shop owner's house. I sat besides Ravi, a Tamil of Colombo origin. He started speaking with one of the other guests, also he from Colombo. After a while I noticed that they no longer spoke Tamil, and that people around started to get upset. Some scolded Ravi and even left. I learned that the language they spoke was Sinhala, and one Indian who also shared our table told me that many got offended, in particular Jaffna Tamils. He said to me that the Jaffna Tamils saw Sinhalese as "*their enemies*". I do not know the exact reason why Ravi had spoken Sinhala, but at that stage he was a bit tipsy, and he clearly seemed to enjoy teasing and upsetting the people present.

The general differences in perception on others between Sri Lankans of different origin were evident. But the manner in which Sri Lankans would perceive and act towards others frequently depended on how they conceived themselves and on what group they identified themselves with at a given time. A Sri Lankan seeing him or herself as Tamil could, for instance, produce different responses or reactions towards his or her environment than if the same person in the same context perceived him- or herself as a Jaffna Tamil or as a Vellala. As various attributed identities could produce different responses from one's environment, people's own different self-conceptions could in a similar way result in diverging actions in the world. People have numerous complex motivations and aspirations which often appeared inconsistent. For instance, people frequently presented opinions that seemed highly contradictory when speaking about how they regarded their situation in India. It is important to understand the dynamics which lead to such apparent contradictory self-presentations as these reveal the complexity and multifacetedness of their life in India.

⁶⁷ According to Wilson (2000), the Sinhalese population in the Northern Province consisted of 2.4% in 1953, and 3.0% in 1981. In the Eastern Province, the numbers were 13.1% and 25.0% respectively. The Sinhalese population in Jaffna was driven out by the LTTE during the Eelam wars.

As stated earlier, people from northern Sri Lanka, more frequently than other Sri Lankans, stressed that they wanted to leave India, either back to a free Tamil Eelam or to Europe or Canada, but sometimes also to a more peaceful and united Sri Lanka. Even so, many Sri Lankans who moved to Europe later purchased land and built houses in India in spite of expressing a dislike towards the country. Ambiga and Rajkumar told me that as a Sri Lankan you were expected not to like India, but they believed that many nevertheless did so in spite of speaking ill of the country. However, as will be evident throughout this dissertation, many Sri Lankans indeed had a difficult time in India, either economically or with the authorities, and clearly wanted to leave. Murugan, a former LTTE cadre, expressed a strong dislike for India, but also he was inconsistent:

Murugan from Point Pedro in northern Jaffna had been in the LTTE for five years as a combatant. He was now living in Raja Nagar with his mother and was taking small jobs to make a living, hoping to be able to go to Europe one day where his older brother was living.

On one occasion at Ambiga and Rajkumar's house Murugan said to me: "*Indians are indecent people. They do not know how to behave. They only do robbery*". He said that nothing of that happened "*...in Tamil Eelam. Only here*". Ambiga, who also was in the room got angry and scolded him. She told him that he lived, worked and got paid here as a foreigner, and that he had no right to speak like this. She told him to go somewhere else if he did not like India. Murugan ignored her and said "*There are no rules or regulations [in India]. Q-branch take money from people, arrest and let go for money*". He said that only 5% of Indian people were good. Ambiga told me afterwards that Murugan hated India because, "*LTTE-people are dying for their country, here people are dying for money, he hates that*".

Later the same evening while we were sitting outside on the stairs of Rajkumar and Ambiga's house enjoying the evening breeze, their Indian neighbour who was an ardent DMK-supporter came by to chat for a moment with Rajkumar. He sat down beside Murugan whose reaction was instant. His eyes changed and got thin, he moved uncomfortably and turned from one side to another. When the neighbour went inside the house with Rajkumar, Murugan shook his head and whispered to me "*I don't like Indians*", with an emphasis on "*don't*".

Murugan always talked about how keen he was to go to Europe, and I understood the reason to be his insecure situation in India as a former LTTE-cadre, as well as his general aversion against the people and various aspects of the country. However, one day he told me that he wanted to return to India and buy a house after having lived in Europe for a few years earning money. I tried to confront him with his earlier statements, but he evaded my questioning. When Ambiga learned this, she laughed and said "*He is lying [about not liking India], he likes India very much*". She repeated her characteristics of Murugan as a very cunning fellow. She also believed that it was the same with most Sri Lankans in Raja Nagar. They all liked India, she said. But she emphasised that they nevertheless liked Sri Lanka better: "*It's their motherland. You like your motherland better, no?*"

Ewing's (1990) theory of shifting selves may elucidate Murugan's apparent inconsistent perceptions of India. She argues that people have different and sometimes conflicting but nevertheless equally important self-conceptions that are experienced as a symbolic, timeless whole, experienced as fundamental and totalising at the given time of an action. These 'selves', which have different value systems, emerge at different times depending on the circumstances in which they are engaged, and on whom they are engaged with. From the outside, such different representations may be interpreted as inconsistencies. Ewing argues that such articulated different 'selves' emerge out of psychological processes of self-reconstitution formed in diverse and usually conflicting social contexts. Besides being context-dependent, these are mutually inconsistent, and may quickly be displaced by other different selves which are based on other definitions of the situation. In this sense, these are what I in the introduction of this chapter labelled doxic and 'discursive-like', as people often are unaware of these shifts and as they largely understand themselves as consistent wholes. In similar ways, Schutz (1970) is concerned with the phenomenological dimension of people's conceptions of the self in relations to their reality. He maintains that people experience themselves as the originators of their ongoing actions and thus comprehend themselves as undivided total selves at any given time. He holds that the knowledge of a person who acts and thinks within the world of his daily life, i.e., his life-world, is not homogenous. It is, he argues, incoherent, only partially clear and not free from contradictions (Schutz 1970:75). A person's various interests are not integrated in a coherent system, but are partially organised under various plans. He argues that the hierarchy of these plans are context-dependent, and thus, one's interests or focus will continually shift. A person will also be only partially interested in clarifying his knowledge. Things will be taken for granted and a full insight into the relations between the elements of his world will seldom be sought for. People's thoughts are spread between subject matters located within different levels, and they are not aware of how they would have to conduct their actions in order to pass from one level to another.

When Murugan in one context express a strong dislike for the country and a wish to leave India, while in another, utters aspirations to return to India and live there as a wealthy man, I argue that this represents a shift between different self-conceptions. The first view was reproduced by a realisation of his past as a former Sri Lankan militant with all the insecurity and fear that this implied (for instance with the Q-branch) and all the disapproving aspects he observed in India and with Indians. Such an identity, affected and disciplined by discursive

formations and by negative external preconceptions and categorisations became a strong incentive for leaving India. However, in the other context, he may have identified himself with the wealthy Sri Lankans in the area who were driving around in flashy cars and who were living in the large white-washed houses. Imagining himself as someone living a good economic and material life may have produced such a self-conception. Similar apparent inconsistent self-presentations existed among many Sri Lankans in Raja Nagar. These were sometimes context-dependent or they emerged out of people's various identifications and aspirations. Various aspirations may have appeared contradictory to others as different hopes and prospects could be activated by different internal motivations or external processes or events. This can be related to life-histories which Knudsen (1990) describes as a cognitive ordering of time into the past, present, and future. Life-histories give meaning to life courses which have been shattered by dramatic events or which have been characterised by discontinuity, such as the lives of refugees. He argues that life-histories are necessary strategic constructions which does not necessarily reflect actual events, but which are formed to suit and order the situations where people relate to others (Knudsen 1990). Most Sri Lankans in Raja Nagar have experienced traumas, loss and destruction and consider their stay in India an intermediate phase, either before returning to Sri Lanka or before continuing their journey to the West – where possible social and economic problems are believed to be resolved. This conceived intermediacy between a past in Sri Lanka and a future back home or in the West may be represented by different prospects and aspirations for a better future. But, as Knudsen argues, life-histories are often generated for the purpose of managing daily life or for coping with their present situation. In Murugan's context, the first representation, when expressing strong dislike and a will to leave India, was expressed while identifying himself with the present, with his current condition of insecurity. The wish to alter this situation emerged out of these negative feelings. The second representation however embodied an aspired identity which was based in the current location, but not in the current situation and in a life transformed by economic amelioration. Moreover, many Sri Lankans who considered themselves highly religious could emphasise the enrichment and benefits of living a simple ascetic life without many possessions. But again in other contexts, they too could identify themselves with a life in the West, which generally were seen as synonymous to getting rich. In similar ways, as we have seen, identifying oneself with one's ethnicity (Tamil), nationality (Sri Lankan or Indian), geographical origin (Jaffna, Colombo etcetera) or with one's caste could also result in the emergence and expressions of diverse and seemingly conflicting self-

presentations, aspirations and views on others. Apparent inconsistent self-representations emerging from various selves, diverse life-histories and various identities thus influenced how people presented themselves to others and how they conceived themselves.

Caste as differentiator

Caste was part of the negative attributes directed toward India and Indians by the Sri Lankans, but it was also an important internal identity marker and social differentiator within the Sri Lankan community. Sri Lankans frequently emphasised that caste was too important in India, and that it was comparably less important in Sri Lanka (see also Dumont 1980). Certain traits and differences of the caste structure in India and Sri Lanka should be clarified, as these will explain some of the notions people held towards caste-related issues. The hierarchical structure of the caste system in India and Sri Lanka are rather different. The former has a Brahmanic structure which places the priestly caste on top, religiously, as well as secularly. Louis Dumont argues that the Varna system regulates function or rituality and purity, and not occupation or birth which is the attribute of the jati classification. Within this system, spiritual authority is ranked above that temporal authority (Dumont 1980). In Sri Lanka however, the cultivator-*jati* of the Vellalas are considered the topmost jati, however only secularly and not religiously (Banks 1960). The Sri Lankan Brahmins are usually from India and do service in Vellala-owned temples, but they have no political power and obtain limited respect outside the temple context (Fuglerud 1999). While the Brahmins comprise only 3% of the population in Tamil Nadu (Subramanian 1999), the Vellalas constitute the numerically absolute majority of the population on the peninsula (Wilson 2000). No political movement resembling the Non-Brahmin movement in Tamil Nadu which aimed at reclaiming 'lost' power and privileges from the high-caste and dominant Brahmins did develop in Sri Lanka, largely due to the society's structural composition and the numerical dominance of the Vellalas. Shanmugathan (1997) also argues that the Vellalas' interests in maintaining this social structure also made resistance against the established system strenuous. Though caste-division among Tamils and Sinhalese are more or less synonymous, Shanmugathan (1997) emphasise that Tamil society nevertheless is of a more rigid caste division than the Sinhalese. Jaffna is reputed for being the most caste-conscious and conservative region on the island (Fuglerud 1999, Pfaffenberger 1994). The Vellalas have always regarded caste-issues as an internal affair which did not concern the state or the Sinhalese majority. There have nevertheless been protests against caste-discrimination in

Jaffna, as for example the temple entry crisis in Jaffna in 1968 (Pfaffenberger 1994). But protests also surfaced during colonial times. Cheran (2001) argues that there was a strong anti-caste social movement during the 1920s, about the time when the political rift between the Tamil and Sinhalese elite emerged. However, the conventional Tamil narrative on the Tamil struggle and Tamil nationalism tend to neglect or ignore this subaltern struggle.

The Karaiyar or fishermen-*jati* on the other hand, is ranked below the Vellalas. But they have historically been influential with reference to trade overseas and in the later stages of the Raj also to smuggling. According to Wilson (2000), the Karaiyars constitute an independent and powerful entity in Tamil society. They owe service to no one, and have own privileges and properties. During much of the colonial period, predominantly the Dutch and Portuguese, they remained independent from the Vellalas. The Sri Lankan Vellalas has traditionally been the political commanding community among the Tamils. But with the emerging conflict and the rise of Tamil militancy, the Karaiyar largely took over as the leading political agents due to its strong bond to the LTTE. Though the Tamil Tigers today is numerically dominated by Vellalas, the leadership is still with the Karaiyars from Valvettithurai. It is also people from this community, led by Prabhakaran and other more Marxist-oriented organisations as for instance EPRLF, which have articulated the aim of eliminating caste-differences⁶⁸.

Comparatively, the constitution in India has banned caste, and many organisations⁶⁹ have aimed at reducing its importance and social impact. Nevertheless, caste has remained an issue of great importance, as caste or community certificates are required when applying for job as a government teacher or for entry into education facilities in Tamil Nadu. This is a legacy from the populist Non-Brahmin or Dravidian movement described in chapter two which aimed at reforming the power structures in the state, favouring emergent Tamil low-caste groups. Dumont (1980) has also described caste in South India as stronger than both in the north and in Sri Lanka. The importance of caste in southern India can also be reflected in the emergence of caste-based parties, of which some also are fairly influential, as the *Dalit*

⁶⁸ The LTTE also had a Marxist profile during the early 1980s largely due to the political inclinations of the organisation's theoretician Anton Balasingham, but this Marxist foundation has now been abandoned for "social equalitarianism as the ideology of the movement" (Balasingham 2001:45). EPRLF on their hand were ardently Marxists. As noted by Adele Balasingham, this was for example reflected in their classic Marxist Che Guevara-like revolutionary "look" and way of dressing with long beards and scruffy clothes (Balasingham 2001). The founder of EPRLF was also a Karaiyar from Valvettithurai.

⁶⁹ For example www.ambedkar.org.

Panthers (DPI)⁷⁰ and the *Vanniyar*-constituted PMK⁷¹. The PMK has for example been accused of pursuing a division of Tamil Nadu along caste lines (Subramanian 2002). Also, caste violence has been recurring in the state of Tamil Nadu, for example between *Dalits* and *Thevars* in the southern parts of the state (The Hindu 2000.10.11, Viswanathan 1998).

Many Sri Lankans disfavoured the position which caste had in Tamil politics and its defining position in various daily social situations. This concerned for instance the many powerful caste-based parties, and the need for caste-certificates to enter universities in Tamil Nadu. Their concern was with the Indian society as a whole, but many nevertheless had a special aversion against higher castes, and primarily Brahmins who often were spoken of as arrogant and conceited. Brahmins were attributed all sorts of negative qualities in the Indian Tamil public and linked to all sorts of conspiracies, also the assassination of Rajiv Gandhi⁷². Muthalingam, a Vellala from Jaffna, said the “*Brahmin theory*” was used actively by local politicians to discredit Brahmins and to accentuate Dravidian ‘values’. This skepticism of Brahmins can be seen in relation to the Dravidian or Non-Brahmin movement, as described in chapter two, where such ideas stood strong. Differences between Brahmins and the Tamils which are of Dravidian origin are reflected not only in relation to racial origin, but to the use of language, and to concrete practices related to purity and pollution (Béteille 1997). Notion of differences were also reproduced among Sri Lankans partly due to the dominant and recurrent negative view on Brahmins among Indian Tamils, but also due to own experiences with Brahmins in the local community.

One day, Ambiga was visited by an Indian Brahmin lady who lived in the neighbourhood. Ambiga learned that the lady had her menstrual period, which ritually, and especially among Brahmins, involves a great number of rules and restrictions concerning cooking, work, movement, general comportment etcetera (see e.g. Dumont 1980, Manu 1991). A woman is considered highly polluted in this

⁷⁰ ‘*Dalit*’ is a term comprising the traditional *outcastes* or *untouchables* – people considered outside the caste system, or the four Varnas. This term is today preferred by Dalit activists as a means of rejecting other widely accepted terms such as *Untouchable*, *Scheduled Caste*, *Depressed Class* or Mahatma Gandhi’s term *Harijan*.

⁷¹ The PMK (*Paattali Makkal Kadchi*) represent the *Vanniyars*, a traditionally low-ranked OBC caste (‘*Other Backward Castes*’), but who have been able to manipulate their status upwards. The *Vanniyars* are one of the numerically strongest jatis in Tamil Nadu, and have their largest concentration in the northern parts of Tamil Nadu. The PMK was in the NDA – the Central Government coalition – and in the Tamil Nadu State-coalition with the DMK (*Dravidar Munnetra Kazhagam*) and the MDMK (*Marumalarchi Dravidar Munnetra Kazhagam*) until they broke away and joined with the AIADMK (*All-India Dravidar Munnetra Kazhagam*) in 2001 due to disputes with its coalition partners. PMK is also known to be one of the more ardent Indian political supporters of the LTTE – together with the MDMK. These issues will be dealt with more extensively in chapter eight.

⁷² As will be made evident in chapter eight, the assassination was subject to a number of conspiracies, from which this was just one.

period⁷³. I was told that this lady was very strict on following regulations on where she could and could not move in her own home, but broke all these rules once she entered Ambiga and Rajkumar's house. Though Ambiga herself was not very concerned about the importance of these rules, she believed that the practice of ignoring the same rules in other people's houses revealed the Brahmins' lack of respect for people of lower castes.

On the other hand, as we have already seen, many Sri Lankans especially from Colombo, emphasised that Jaffna Tamils, and in particular Vellalas were too preoccupied with caste and that they discriminated others. Much of the resentment against Jaffna Tamils was principally directed at Jaffna Vellalas. Ambiga, who was of a goldsmith caste (*Asari*), for example said that Jaffna Vellalas were "...very keen on caste; after they come here, less non". She said that in Sri Lanka "*they won't let me enter fully the house*", because they frequently considered people of lower castes to be polluted. She said that she could barely get into their hall. And if you were invited into their houses, they would most likely offer you nothing. If they did, you would get tea in a glass and not in a metal tumbler – glasses were for lower-caste people, while tumblers were for high-castes. Ambiga said they offered tea in glasses to lower-caste Tamils and to Sinhalese. "*After I left the house, they wash the house with turmeric water*"⁷⁴. I asked her if Jaffna Tamils were as preoccupied with caste after they came to India. She replied, "*No, not anymore. Only when marry*". She said, "*Children go to foreign countries, their minds change, no?*"

Even though many lower-caste Sri Lankans said that the importance of caste among high-castes seemed to have decreased after having moved to India, many nevertheless maintained their skepticism towards them. While their experiences in Sri Lanka seem to have been significant for such an understanding, caste was never presented to me as a direct reason for conflicts between Sri Lankans in Raja Nagar, though it was often used to explain why certain people acted in specific ways. People from particular castes were usually seen by others to possess certain primordial qualities. When for instance a Vellala behaved in improper ways, people frequently emphasised that such behaviour was typical for Vellalas. But if a Vellala behaved righteously, this person was often accentuated as an exception from the norm, and

⁷³ Several sections of the 'Laws of Manu', which is the most important Hindu text on Dharma – Hindu law or duty, refer to the impurity of menstruating women. A Vedic graduate is for instance said to lose his wisdom by conversing with a menstruating woman (Manu 1991:4 verse 57), and a priest should not eat the food touched by a menstruating woman (Manu 1991:4 verse 208). A woman becomes clean when bathing after the bleeding has stopped (Manu 1991:5 verse 66). According to Dumont (1980), Brahmins 'are' purity. They have certain privileges, but are also punished harder than other Varnas for the same misdeeds. Impurity is more powerful than purity, and the purer you are the more impure you get when you become polluted, and the longer it takes to be purified.

⁷⁴ Turmeric water is considered ritually purifying and used as a decontaminator.

his personal traits were accentuated at the cost of qualities linked to his caste-background. The demonisation and collective social degradation of the Sri Lankans following the assassination may also have influenced the Sri Lankans' approach to caste. The internalisation of this new status, which is a crucial facet of the disciplinary side of the transformation of the Sri Lankans, may have incapacitated the chances of the high-caste Sri Lankans to act out their caste status against people from lower castes. However, though caste appears to have been subdued as a social differentiator within the Sri Lankan community in Raja Nagar, former experiences in Sri Lanka appeared to have been significant for people in maintaining an awareness of difference among many people.

FLUCTUATING IDENTITIES AND COPING STRATEGIES

The categories which people were considered to be part of, whether national, ethnic or other, were not always constant. People did occasionally have problems defining themselves as belonging to a specific group, seeing themselves as part of a different group than that which they were deemed by others, or they might consider themselves as part of several groups. Schutz (1970) also maintains that individuals find themselves as members of numerous social groups, and continuously stand at the intersection between several social circles. Furthermore, Sri Lankans occasionally tried to manipulate personal traits and characteristics to avoid unwanted external categorisations, and thus to evade potentially unfavourable consequences. In other circumstances, some identities, such as that of being a refugee could alternatively be sought for or tried avoided in order to obtain a specific status or approaches from others. "Juggling" with an identity presumes that it is laden with a specific meaning. A dominant understanding of an identity is thus accepted and used counter-hegemonically in order to obtain specific objectives.

Blurred identities

The so-called repatriates or Upcountry Tamils were in many ways between the devil and the deep blue sea relating to ethnic or national identities and categorisation. As we saw in chapter two, these Sri Lankans of Indian origin were made stateless on the island due to their Indian ancestry. In spite of concessions and agreements between India and Sri Lanka⁷⁵ aiming at

⁷⁵ They were rendered stateless after the implementation of the 'Ceylon Citizenship Act of 1948' and the 'Indian and Pakistani residents (Citizenship) Act of 1949'. Agreements between India and Sri Lanka in 1964 and 1974 aimed at resolving their citizenship question, but did not fully succeed.

solving this problem, many Upcountry Tamils have remained stateless on the island. These agreements forced many to take an Indian citizenship, while others chose it.

Sivan, one of Sivanesan's friends was a repatriate from the Sri Lankan Hill Country. As he was rendered stateless in Sri Lanka, he accepted an offer to become an Indian citizen. When I asked him whether he felt like an Indian or a Sri Lankan, he said that he felt like a "*Ceylonese*", as he had lived in Sri Lanka the major part of his life. He had chosen to become an Indian citizen, as he believed India would be a good country to live in. He told me that he had always admired India, but was disappointed when he came here. As being an Indian national, but feeling like a Sri Lankan, I asked him how Indians considered him. He replied that people in India held him to be a Sri Lankan and not an Indian. Sivan told me that most of his family have become Indian citizens, but said that he still has a brother living in Sri Lanka who now was a Sri Lankan national.

Shankar, another informant of Sri Lankan Upcountry origin occupied an Indian passport and presented himself as an Indian, but had a father who considered himself a Sri Lankan. The father received his repatriation papers and moved to India in 1977 after having lost his job at the estate where he had worked. Though Shankar *per se* was an Indian, he also recognised himself as partly Sri Lankan. He emphasised his Sri Lankan descent as a reason for getting well along with the Sri Lankans in Raja Nagar.

There could also be divergence in identities within families, for instance when parents had grown up in Sri Lanka but had to flee the country due to violence, while the children had grown up and lived most of their lives in India.

Rajkumar and Ambiga's family was one such case. Rajkumar and Ambiga, as well as their daughter were born in Sri Lanka, and were Sri Lankan citizens. Their son however was born in India and was therefore an Indian national. His mother thought it a bit strange that he in fact was Indian, but nevertheless appreciated it. It would be beneficial for him for his future education and work opportunities, as he was going to grow up in the Indian society. They had decided never to return to Sri Lanka. In spite of his *de facto* nationality, his parents, their neighbours and family friends saw him as a Sri Lankan.

Sivanesan's daughter Mahadevi came to India in 1983 when she was seven, and remembered very little from the years in Sri Lanka. When we discussed her and her father's different attitude towards Indians she was considerably more positive than he, and she frequently scolded him for his negative opinions on Indians. I asked her whether she felt Indian or Sri Lankan, she said, "*I feel Indo-Sri Lankan ... I am born in Sri Lanka, but settled here*".

The recurring discrepancies between external and internal categorisation is noteworthy especially with reference to the repatriates, a population which for several decades were largely left uncared for by the governments of India and Sri Lanka. Furthermore, the frequently rigid categorisations employed by people were not always in compliance with individual experiences and conceptions. As we saw in the above narratives, family members from different generations who had diverging experiences often perceived and acted in their world in conflicting ways. Sivanesan often spoke of his former life in Colombo with great affection, but after coming to India he had been repeatedly deceived and had eventually turned into a poor man. Mahadevi's experiences on the other hand were different. She remembered little from the years in Colombo prior to their flight, she had gone to school with mainly Indian students and she also had an Indian boyfriend. Their different experiences made them conceive their environment differently, though the surroundings to a certain degree were shared.

Also, the place of residence appeared to influence people's perception on India. As stated earlier, the Sri Lankans who lived in areas with fewer Sri Lankans appeared to have a more positive attitude to the country than people who lived in areas densely populated with Sri Lankans. A similar pattern is also reflected in Malkki's (1995a) book on Burundian Hutu refugees in Tanzania. While the refugees in the town of Kigoma used various strategies to integrate into the local community, the camp refugees were highly preoccupied with their Burundian descent, and scorned the town refugees for neglecting and ignoring their origin. Sri Lankans in areas with fewer countrymen often appeared to have adapted more easily into their local environment, having been forced to redefine their preconceived perception of the world. Following Schutz (1970) argumentation, as a stranger, one lacks the status as a member of the social group in which one wishes to join. One's conception of the world is based on a different logic, system of relevance and stock of knowledge. One is no longer in the centre of one's social environment; the person is outside the territory covered by the scheme of orientation of the group he wishes to join. People will, thus, partially have to adapt, that is, transform or accommodate their system of relevance to the one prevailing in the new group in order to be accepted and to resist outside criticism. Such a shift of conception or of system of relevance is not necessary to function or to be in the centre of a familiar environment, such as in Raja Nagar which has a substantial Sri Lankan population.

Anonymity and the disguising of identities

In certain circumstances, Sri Lankans concealed specific identities or adopted strategies to avoid certain labels from others. Some Sri Lankans purposely avoided circumstances which could lead to an identification of them as such. Being Sri Lankan in India implied being at risk of sanctions from Indians, either from officials but also from common people.

Raja from Colombo told me that he had taken an auto one day in Akhadipuram. He had been discussing the price for a long time with the auto-driver who wanted 80 INR, but Raja eventually got his price – 50 INR – which was what he usually paid. When arriving at the requested spot, the auto-driver again demanded 80 INR and told other auto-drivers who were there that a Sri Lankan fellow was trying to cheat him. In fear of being beaten up by the aggressive auto-drivers, Raja paid the 80 rupees.

The same Raja said to me that he often avoided speaking Tamil on the bus, to avoid being identified and attract attention as a Sri Lankan. He told me about an episode where he and his friend Thomas had been on a local bus. Two young boys had sexually harassed a woman on a bus. The most eager one did also touch the woman's breasts. Raja said that nobody on the bus had done anything, and the woman ran weeping out from the bus when she arrived at her destination. Raja and Thomas were revolted by the boys' behaviour, and said that such things never happened in Sri Lanka. I asked them why they did not do anything. They told me that they were easily recognisable as Sri Lankans due to their dialect, face and clothing, and that the Indians on the bus would have got angry with them if two Sri Lankans tried to intervene. Raja told me that he and Thomas spoke Sinhala on the bus so nobody would understand what they said. Somebody had asked them what language they spoke, whereupon Raja answered "*Kannada*" – the language spoken in neighbouring Karnataka.

Rajkumar who had lived in India for almost 10 years had partially adopted a local Indian Tamil dialect, but still with some of the old Sri Lankan Tamil parlance remaining. Due to this mix, people had problems identifying where he was from. He said to me that he used to tell people he was from Kerala to avoid eventual problems from people who did not like Sri Lankans.

These examples underline the potential power inherent in an external categorisation (Jenkins 1996). The very nature of the Sri Lankans' situation after 1991, represented by their transformation and demonisation was reflected by the disciplining of their general comportment in a potentially insecure environment. As will be evident in chapter eight, Sri Lankans often contested the official version of the assassination as a sort of resistance. They were confronting the event which had been interpreted as the reason for their miseries. In spite of this, it is evident that the discursive transformation of the Sri Lankans had an impact on their behaviour which went deeper than sensing they were not appreciated in India. Their

common fear of sanctions and reactions, like Raja's experience in the auto above, led Sri Lankans to try to undercommunicate their national identity as a safety producing act. Occurrences such as this further challenged local trust and confidence. In this sense, following Foucault's (1980, 1999b) argumentation, the Indian population were, as the fellow-men of the Sri Lankans also the vehicles of the discursive power. They were, when relating to the Sri Lankans in similar ways undergoing and exercising this discursive, circular and net-like organised power. They too accept the premises of the discourse in which they naturally or commonsensically participated and were thus agents for the reproduction of the detrimental status of the Sri Lankans.

The 'Sri Lankan refugee' identity

The 'Refugee' identity was significant for the Sri Lankans as it was regularly attributed them by the Indian government, by NGO's and by Indian locals, and it was sometimes also used by them. It was an identity they had to relate to in their daily life, but it was no less a controversial term. It was on the one side appropriate, one could say, as it reflected the perceived displacement of the Sri Lankans. But it is also a reductionist and politicised term loaded with meaning.

'Refugees' are usually regarded a vast category of people, dislocated and externalised from the national order of things, from their places of origin as well of their new place of habitation. Malkki (1992, 1995a) maintains that the refugee often is conceived as a liminal figure⁷⁶, as a 'naked unaccommodated man', uprooted and torn loose from the culture which the person is seen as naturally tied (see e.g. Stein 1981, Suryanarayan and Sudarsen 2000). Such an approach construes refugees as a category of 'cultureless' and 'nationless' people with no individuality and often with internal differences neutralised (Daniel and Knudsen 1995). They may be seen to have lost the authority to stand for 'their kind', or for the 'whole' which they were seen to be a part of, and their connexion or bond to the place where they have settled as 'refugees' may in similar ways be rejected. Liisa Malkki argues that such dominant conceptions of 'the refugee' or that of being 'in exile' are constituted through an array of different discursive and institutional domains, including international law, the documentary production of the UN and other refugee agencies, development studies and literary studies.

⁷⁶ Liminality refers to a transitional condition between states often represented in *rites de passages*. One is at the same time no longer part of the former condition and not yet part of the coming, or both no longer and not yet classified. One falls outside the natural order of things (see e.g. Turner 1967, 1991).

She directs her attention to the management of displacement in Europe in the wake of World War II when the 'refugee' emerged as a knowable and nameable figure and as an object of social and scientific interest. Until this point, refugees were approached as a military and not as a humanitarian problem (Malkki 1995b). This should be related to the nation or 'the national order of things', which is deeply cultural and territorial but at the same time global and trans-national (Malkki 1992:37). This is ironically linked and complementary to the common understanding of the refugee as someone outside this 'national order of things'. They are mutually sustaining as both rely on national identities (Daniel and Knudsen 1995). Malkki maintains that one of the global aspects of the nation is its regime of classification, ordering and sorting people into kinds and types. This, she argues, represents a Foucauldian naturalising physics of power, which is at once micro-political and monumental in scale (Malkki 1995a:6). Dominant understandings of the refugee have thus largely been consolidated in public debates, NGO relief programmes, but also in people's general conceptions. With the status of the Sri Lankans after 1991, they found themselves outside the 'national order of things' as refugees, in addition to being discursively redefined to a community of potential terrorists. The refugee label became an additional stigma where they often were deemed an economic and social burden for India, as for instance stressed by Bastiampillai (1996).

Malkki (1992, 1995a) and Daniel and Knudsen (1995) have pointed out the difficulties that academics have with the notion of 'refugee' or of "refugee-ness" – the state of being a refugee. In the social environment in which my informants oriented themselves, the reductionist understanding of 'refugee' – as a notion largely immobilising the person, reducing him to a victim of his surroundings, and which defines him as someone unable to take decisive control over his life – was in similar ways predominant. However, this dominant conception was prevalent among NGOs, such as OfERR and gave support to the implementation of their empowerment programmes and relief work. But as the Sri Lankans had to relate to this refugee label, it also gave them the opportunity to choose whether to direct people's attention towards it or not and by this to shape one's self-presentation and identity. In an event which I have described in more details in chapter eight, one of my informants told me that he was stopped by a policeman for driving on red light. This was in the early 1980s when Sri Lankans still were supported and approved of by the Indian Tamil population. The policeman started making queries and insinuated that my informant had to

pay a bribe to avoid serious trouble. However, when the policeman learned that he was a Sri Lankan refugee, the policeman did not only let him off without a fine, but also bought him tea. This does not only reflect the conception of the “victimised kin” prevailing in the early 1980s, but also the view of “the naked and unaccommodated man”. But the givenness of this term was problematic for my informants in their self-categorisation when they did not identify themselves with these reductionist connotations. The givenness of the term also poses a semantic problem. In the circumstances where people made references between themselves as Sri Lankans in India and that of being a refugee, their presentations could imply the ‘traditional’ understanding of a refugee, as the deterritorialized “nationless” victim of repression. On the other, however, being a refugee could also be spoken of simply as a person who had fled the armed conflict. In this view, people did not include or infuse any meaning which reduced them to be “nationless”, “cultureless” or that of being a “naked unaccommodated man”, or other similar associations. As the ‘traditional’ and loaded connotations assigned to the refugee-notion largely were seen as given, it was difficult for my informants to speak of themselves using the term without falling into the “naked unaccommodated man”-trap. One Sri Lankan lady for example stated that she was fed up with the refugee-label. She said, “*I am not a refugee, I am a human being*”. This statement both implicitly recognises this reductionist conception and in a counter-hegemonic logic reacts to it within the framework of this given approach.

On the other hand, simultaneous references to both semantic perceptions also occurred. Jegan was a Vellala from Jaffna in his late sixties who fled the island by boat in 1990. On one occasion when he spoke about his life, he maintained that he was not a refugee; he did not like that word he said. However, not long after during the same conversation, he stated that he had been a refugee from the war for 15 years, internally (as an IDP) in Sri Lanka as well as in India. This, I believe, does not necessarily imply a contradiction, but is more a matter of semantic divergence. I see Jegan’s first statement as a critique and rejection of the “traditional” reductionist notion of “refugee-ness”, but his second statement – when stating that he was a refugee, is no more than a simple account of having fled the war. But “refugee” is the only word which describes this status or condition.

In certain circumstances however, a socially deprived refugee- or victim-identity was sought after and accepted by Sri Lankans. One time when Garnet, one of my main informants,

spoke of his youth in the village in the Sri Lankan Highland where he grew up, he told me “*I miss the country (Sri Lanka) very much, now I am like a walking corpse*”. The symbolic self-presentation of being a walking corpse as a result of being away from his country of origin, and being unable to return has strong connotations. It fulfils many of the traditional approaches to refugees criticised by Malkki, for example the picture of the “liminal naked unaccommodated man”, and it also gives associations to that of being “uprooted”. This can also be seen in relation to the concept of ‘ur’, of which people are continuously shaped and which is principal for their self-definition. The substance of its soil is seen to generate particular qualities. Sivanesan made similar associations. He told me how his life had deteriorated during the last years, and compared it to how it had been before 1983 when he fled the island. He said; “*My life is a failure ... I have lost all my friends, relations, wealth, everything. Here, I am only with my wife, two children in this large country. I have been quite unlucky*”. Though he did not use the word “refugee” to describe his situation, his statement brings forth similar associations. By presenting himself as left “*in this large country*” – India, “*only*” with his family, he portrayed himself as small, unaided, victimised and vulnerable.

These presentations, which are not unique for these two people, represent a general divergence with their other regular self-representation. Garnet stated on another occasion that he loved India for its vastness, and for the great possibilities and freedom he had and experienced there. This differs radically from the “*walking corpse*” he described himself as earlier. Such apparent contradictions may be seen in relation to the earlier presented life-histories where refugees often identify themselves with their past life as a way of coping with a difficult present condition (Knudsen 1995). Diverging presentations seemed to be pronounced in contexts where people related previous favourable situations or statuses to a present less auspicious one – as the case was with Garnet and Sivanesan above. Garnet was talking about his pleasant youth and Sivanesan about his former wealth and good life-condition. These life-histories are strategically employed to organise and create meaning in social relations (Knudsen 1990). But these strategic constructions may also be unconscious and be conceived as inconsistent by listeners. Knudsen emphasises that the presented life-histories must be seen neither as true nor false in the right sense of the words, though refugees often emphasise their life-histories as actual pictures on who they are. People’s diverging or seemingly inconsistent self-presentation are conceived as true when they are pronounced, but the nature of these will necessarily be highly context-dependent (Ewing

1990, Knudsen 1990, Schutz 1970). Knudsen (1990) also maintains that people's presentations of their life-histories vary according to whom the listener is.

With reference to Ewing's (1990) theory of shifting selves, I argue that Garnet and Sivanesan operated with conflicting but equally important statuses linked to different value systems in their self-presentations. At one point they did recall a previous, but now lost "favourable" status, with which they identified themselves. A self-identification with such a loss or with that of being a victim or a refugee, results in actions or statements which has its immediate emotional and ideological foundation in this identification. In other circumstances, if they for example are engaged in a good business, as the case was when Garnet described India as a country he loved for its vastness, possibilities and freedom, people's self-representations and actions are different, and they may present their current situation as good. It is, in other words, not a matter of inconsistency when people vary their self-presentations, but rather due to 'various selves', inhabiting conflicting value systems which are "activated" or emphasised in different situations.

LOCAL DYNAMICS AND EXPERIENCES

People's identities were influenced by people's interactions and understandings of each other. But they were on the other hand also the result of experiences and local dynamics, seen in relation to the discursive transformation of the Sri Lankans. But as argued elsewhere, the nature of the relationship between Sri Lankans and Indians seemed to vary in accordance with the density of Sri Lankans in the respective areas and neighbourhoods. Sri Lankans who lived in areas with fewer countrymen, and who thus interacted more with Indians generally appeared to have a more positive attitude towards India and Indians.

In order to apprehend the relationship between people I find it vital to focus on people's experiences, local negotiations and orientations, as well as how their surrounding environment, as an intersubjectively construed locality is perceived. These aspects are of fundamental importance for understanding the identity formations and negotiations described earlier in this chapter. A notion of the Indian state as exercising a repressive policy is conceived by interpreting and drawing conclusions from representations of the state, own and other's experiences or from stories told by fellow-men. Such interpretations have a locality producing effect, again as applied by Appadurai (1995), which may be laden with

fear and suspiciousness and which thus may have disciplining consequences. Such conceptions will thus be embodied in people's succeeding actions and orientations. While the repressive formations will be more of an underlying factor in people's life-worlds, local conditions and experiences emerged as more perceptible and thus influence local life in Raja Nagar more directly.

CORRUPTION, MEDIA AND ENCOUNTERS WITH THE STATE

Before approaching local issues and experiences in Raja Nagar, other aspects which influenced Sri Lankans' conceptions of India and Indians should be highlighted. It is essential to identify the Sri Lankans' encounters with the Indian state and to recognise the mediums and institutions that are seen to influence their lives. The Sri Lankans encountered the Indian state largely through its local bureaucracy and immigration authorities. This is important, because as Akhil Gupta contends, trans-local institutions such as the state may come to be imagined through the practices of local institutions (Gupta 1995:384).

Having Gupta's argument in mind, the Sri Lankans' encounters with the local or district bureaucracy often involved extortion and corruption and often led Sri Lankans to conceive corruption as a general feature of the Indian state. Circumstances such as when the Sri Lankans arrived to India, when they conducted their compulsory registration at the local Foreigners' Registration Office, or if they tried to get the necessary official papers when travelling abroad, were accentuated as situations where corruption and extortion was prevalent. On the other hand, Gupta accentuates that people may understand the Central Government's initial intentions to be good, but that these end up being frustrated by venal officials in its local implementations. However, in the context of the Sri Lankans in Raja Nagar, the intentions of the Central and State Government were also questioned. The Central Government was considered supportive of the Sri Lankan government for supporting their warfare against the LTTE. The restrictions introduced by the Tamil Nadu Chief Minister Jayalalitha (but after being advised by the Central Government) in 1993 were in addition seen as representations of the deceitfulness of the Tamil Nadu state government. The regular allegations of corruption involving high state officials, and frequently Jayalalitha (see e.g. Subramanian 2000, The Hindu 2001.06.11), further confirmed this position.

As in Gupta's examples from Uttar Pradesh, mass media was significant for how many Sri Lankans comprehended political processes on local, state and national level. That is, in understanding the state as complex and multilocal. My informants' use of media consisted of local Tamil papers, English dailies such as 'The Hindu' and 'The Indian Express', as well as broadcasted news on television and radio. Without neglecting the diverse situatedness of various people, their level of education, origin, caste and class and so on, media was important for people to conceptualise the impact of the state on their lives. It was here that people learned about the implementation of central and state policies, about the Indian government's interpretations of the situation in Sri Lanka, about local issues related to caste and gender, and it was through these mediums that they frequently conceived the local Indian presentations of the Sri Lankans.

Sri Lankans generally had strong opinions on the various news agencies, and many accused these for being biased and for presenting negative images of Sri Lankans and the LTTE. Sivanesan for instance labelled the fortnightly political magazine '*Frontline*' as a "*Rubish book*". He used to read it in 1985 he said, and maintained that it was good at that time. He believed it was the same with most Indian papers. They were bad, always uncritically pro-India and were never questioning India's foreign involvements. Some journalists were nevertheless highly esteemed while others were strongly disliked. People's conceptions were on some occasions shaped by media's representations, but media's objectivity could often be questioned when they conflicted with their own well-established conceptions. I discussed the different attitudes of various Indian newspapers with Aadlarasu, a former PLOTE militant. We were initially discussing LTTE's activities in the Tamil areas of Sri Lanka. As a former member of PLOTE he loathed the LTTE, and gave them the entire blame for the collapse of the IPKF operation. In spite of this, he claimed that some newspapers were so populist and so strongly opposed to the Tigers that they would have describe our discussions as an LTTE meeting in tomorrow's paper if they would have been present.

As the Indian state largely was construed and imagined through media and meetings with local bureaucrats, it is also through these encounters that the power inherent in the dominant discourse is conceived and consolidated for the Sri Lankan community. The ways in which media reflects upon the Sri Lankan question, the way it covers and describes political issues relevant to the Sri Lankans, and the ways in which local bureaucrats act towards the Sri

Lankans and implement its policies are all within the logic of a dominant national discourse. This is a notion I will discuss in details in chapter eight.

LOCAL EXPERIENCES AND CONCEPTIONS OF PRIMORDIALITY

People's comprehensions of 'others', the negotiation of identities presented initially in this chapter were profoundly determined by local processes and experiences, formations which had a more direct impact on people's lives. People who already had had their lives disrupted were alert to new potentially detrimental circumstances which could lead to new disruptions.

Sri Lankans' experiences

The preconceptions of the Sri Lankans on Indians were thus normally based in experiences, but also in stories and popular conceptions circulating among friends and neighbours in the community. Sri Lankans often stressed experiences of deceit and discrimination to show the difficulties they had been through in India. For instance Sivanesan claimed he had lost many good and well paid jobs because of dishonest Indian bosses who exploited him because he was a Sri Lankan.

After fleeing Sri Lanka after the Colombo riots of 1983, Sivanesan lived for some time in a refugee camp with his father, wife and two daughters. After his father died they moved out from the camp. Sivanesan got work in the hills in Tamil Nadu, while his family lived down in the plains. He told me that he had a very good job, and that he earned well. He said that he spent a lot of money at the time, and saved little of his earnings. However, after 10 years, he got a new boss, a Malayalee. He claimed that his new boss did not like Sri Lankans, and eventually fired Sivanesan because he wanted to engage another Malayalee. Sivanesan told me that this man still owed him 75,000 INR in salary. After this he got work at a farm. He said he got a leading position after some time, and claimed that he transformed the place into a paradise. However, a local manager disliked Sivanesan and told him that Sri Lankans should not work at the Estate. Eventually, the local manager got him fired. Sivanesan said that even though the job was underpaid, the local manager still owed him 5,000 INR.

Another time he also told me eagerly "*You know I had an ice cream bar. It was running very nicely, but they cheated me. I had an Indian partner. The share of income was accumulating. I wanted to become a full time partner [...] I was an investment partner, and I wanted to make 50-50. Without my knowledge, that fellow drew out that money*". He continued by saying "*Sri Lankans are suffering in the hands of the Government, businessmen. Two lakhs Sri Lankans don't get proper paid, food, shelter. Some go at six or eight in the morning and come back at ten, eleven o'clock*".

He told me that he used to have many Indian friends who came to his house while he still had a good economy. However, when his financial problems began, his “friends” disappeared, and nobody helped him though he had helped them before. He told me:

“I shouldn’t have come to India; I made the biggest mistake coming to India. I had a great love for India, Indian people, culture and all these things. [...] My experience during the past 18 years is that all my expectations were completely destroyed. According to me, people are very narrow-minded, selfish and possessive. [...] Practically, they are very cruel, especially the politicians and Government officials, even the businessmen. They try to grab your possessions when they come to know that you have something. Their attitude is somewhat indifferent. They don’t give salary, they squeeze out your blood by employing, they take maximum use of your knowledge and labour and everything, but they don’t pay you well, don’t take care of your health and welfare, keep you up for a long time without giving you rest, and pressurise. The employment is also not secure. Immediately without anything they throw you out. You always live in a sense of insecurity”.

Poverty and the lack of help from others shaped the perceptions of others too. Ambiga and Rajkumar came to India with only 1,000 LKR in 1993 and struggled tremendously the first years. They received little help from others but managed to obtain a decent life and a sustaining economy through hard work. However, these experiences could occasionally affect their attitude and comportment towards others. Though they always scolded Sri Lankans who criticised India and told them not to complain about the country that fed and sheltered them, they too stressed the indecency of Indians when they were reminded of their first difficult years in India or when they had Indian customers who did not pay for jewellery orders or stitching jobs. Ambiga and Rajkumar, like many other Sri Lankans who had experienced great suffering, were attentive to potentially new disruptive situations.

One afternoon when arriving to Ambiga and Rajkumar’s house, I noticed them being very upset. I did not have time to ask what had happened before Ambiga started telling me about one of Rajkumar’s relatives. He was now living in India but had a business in Colombo from which he earned more than 50,000 LKR per month. A few years ago, while they still met him on a regular basis, they asked him if he did not want to move to Raja Nagar. He said that he did not want to; it was like living in the forest he told them. Ambiga told me about an incident around this time. Their relative had to go to Sri Lanka the following day, something urgent had come up. He asked Ambiga if she could help him get a flight ticket, he was unable to do it himself, he told her. Ambiga went to the person in charge of Air Lanka and arranged a ticket for him without paying anything extra. She stressed that she did not ask for anything for the job from the relative either, even though many would have done so. Some weeks later, in Ambiga’s presence, he was bragging to some friends that he could arrange tickets for people to go to Sri Lanka the very next day, and that it would only cost them 300 INR extra. Ambiga said she that this provoked her immensely as she

had done this for him without asking for any commission. The reason why they were upset this afternoon was because they had received news that this relative wanted to open up a jewellery shop in Raja Nagar close to their house where Rajkumar had most of his customers for his jewellery business. Ambiga said that Raja Nagar was not good enough for him to live in, but still he was going to start a jewellery shop in the area. She believed he was jealous at them for their success with the jewellery business, and that he wanted to ruin their business and steal Rajkumar's customers. She said that he could have opened a jewellery shop anywhere, but why here? He was earning enough on his business in Colombo, and did not need to open a business in Raja Nagar. Another thing that provoked Ambiga maybe even more was that Murugan had told them that he was going to help their relative to get customers. Ambiga said that she and Rajumar got angry with him and scolded him when he told them. They told him "*you help our relative, God is helping us*". Murugan also got angry at them. Ambiga said that they had known Murugan for many years and he had never brought them any customers, and now he was going to help their relative whom he did not now very well and who already had plenty of money. Rajkumar entered the conversation and said that he was going to report Murugan to the Q-branch (about his former LTTE link), if he was going to help their relative. He said that Murugan would end up in "*the Madurai-camp*"⁷⁷. I said to Rajkumar that it was a very serious thing to inform the Q-branch about Murugan, and asked him if he was really serious about doing this. Rajkumar, who was really upset, said that he was determined to do so.

However, a few days later I asked Ambiga if Rajkumar still was determined to report Murugan to the Q-branch. She smiled and said that he would never do such a thing, Rajkumar was too good-hearted. Rajkumar who heard her, made a loud and quick remark in Tamil. Ambiga did not tell me what he said; she just smiled and chuckled to herself.

For Ambiga and Rajkumar, this situation represented the prospects of having their lives fractured once again by someone close. On two occasions, they had their lives completely disrupted, and they struggled immensely to re-establish a sustainable life-condition. They told me that they would never let someone ruin their life again. I hardly ever saw Rajkumar, who was relatively sober in his comportment this angry and upset. This incident reflects the importance of former experiences, and how this influence and affect the present. As Schutz (1970) argues, all interpretations of this world is based on our store of experiences. The way people reacted to potential disrupting situations would necessarily vary depending on one's stock of knowledge. This is produced by our interpreted experiences and is highly personal and unique. Though this last narrative portrays an experience-based way of relating to an insecure environment, the inherent fear for having their lives disrupted again should also in a general sense be seen in relation to the common negative qualities attributed to Indians. I believe the general mistrust against Indians and the frequent reproduction of negative

⁷⁷ One of the Special Camps.

stereotypes, through the interpretation of events, and through tales from neighbours and friends, have resulted in an ‘alertness’ unbeknownst to most Indians due to their lack of similar experiences. It is in a sense what Chandran talked about when he said that Sri Lankans were different from Indians as all their difficult experiences had matured them. Generally speaking, difficult experiences made many Sri Lankans approach their environment in a different way than Indians. The fear for having their lives disrupted anew may be strengthened when dealing with the Indian population whom they attributed strong negative qualities.

Indians’ experiences

Likewise, the Indians’ set of arguments additional to the assassination for their disapproval of the Sri Lankans, where in a similar sense based on experiences, local dynamics and practices, and like the Sri Lankans, also in primordial conceptions of the ‘other’.

A central objection among Indians in Raja Nagar and elsewhere were the many violent incidents involving Sri Lankan militants in India. The Sri Lankans were frequently held responsible for introducing a “gun-culture in the state”, which Indians claimed was non-existent before their arrival. Many Indians recalled the numerous violent shooting episodes involving rival militants in Madras where also Indians were killed (see chapter two). Another aspect was the increased prices after the influx of the Sri Lankans in the state. Indians emphasised that wealthy Sri Lankans paid excessive house-rents once they came to Tamil Nadu, where they also spent money lavishly. This, they argued forced a general price increase in the whole state which severely affected their economy. As briefly stated above, Indians further believed that many Sri Lankans were involved in illegal businesses like smuggling, passport forgery and such. This was also underscored by the frequent reports in media about smuggling (The Hindu 2000.06.11, 2001.02.19a), armed robbery (The Hindu 2000.01.07), passport forgery (The Hindu 2000.08.30, 2000.11.12, 2000.11.21), Sri Lankans not possessing valid documents (The Hindu 2000.09.07) and drug dealings (The Hindu 2000.01.11, 2000.11.02). Chandran said that many Sri Lankans were “*fanatics*”, and that they wanted a separate country at any cost. He believed most Sri Lankans were involved in some kind of illegal business, and that some had two or even three passports with different names. Many were dealing with money business, with U.S dollars he said. In addition, much of this illegal business was believed to be linked to the LTTE. Many Indians were firm that the majority of

the Sri Lankans had connexions, or at least supported the banned organisation. In this context, some Indians stated that the LTTE had betrayed the IPKF who went to island with the intentions of helping the Sri Lankan Tamils, and like Aadlarasu, held the Tigers responsible for the breakdown of the peacekeeping operation and for the large number of Indian casualties. Another aspect which appeared to be of great significance for many Indian Tamils, as seen from some of the former narratives, was the mistreatment of Indian labourers in Ceylon by local (primarily Jaffna) Tamils in the 19th century. As we could observe from the narrative where my Indian and Sri Lankan Vellala friends met and talked, the former not being aware of the latter's background, many Indians frequently held that the Jaffna Tamils' considered themselves superior of others. High caste Jaffna Tamil politicians were held responsible for rendering the Upcountry Tamils stateless through political brinkmanship (see Chapter two). While the two last arguments (the mistreatment of the Upcountry Tamils and ruining the IPKF operation) emphasised the arrogance and indecency of Sri Lankan Tamils, primarily high caste people from Jaffna, the other aspects emphasised the problems the Sri Lankans had created in their environment. With reference to their behaviour in India, they were attributed a number of negative qualities.

GENDER, CORPORAL SYMBOLISM AND DRESSING

Having approached ways in which the state is construed by the Sri Lankans and how local experiences have influenced the relationship between the communities in Raja Nagar, it is significant to stress the means in which people frequently demarcated and categorised other communities. In the process of identity negotiations, certain perceptible features and traits were recognised as particular for people from a specific community and were used to identify and categorise persons. In some contexts such notions would contain a whole set of meaning. Women are important in this context, as they regularly were seen as cultural markers defining the respectability of a community. Preconceptions on how women from a specific community comported themselves would largely define how communities as a whole were conceived. In other words, by emphasising the lack of morality of women in a community one is also degrading the honour and integrity of the whole community.

People's behavioural and bodily traits were frequently used as means to identify and categorise others. As presented above, some Sri Lankans tried to conceal their national origin as a coping strategy, but their easily distinguishable Sri Lankan dialects often betrayed them.

Moreover, people from both nationalities maintained that they could distinguish a Sri Lankan from an Indian by their appearance only. Some people spoke of the way of dressing, the use of jewellery, or general comportment and stature as demarcating features. Sri Lankans were known to wear more jewellery than Indians and many said that buying jewellery was a way of investing money till the day they were to return to Sri Lanka. Younger Sri Lankans generally dressed more 'modern' than Indians, but the 'traditional' way of dressing could also diverge from the traditional Indian code. Sometimes people also found it difficult to point out exactly what it was that distinguished the two peoples, but maintained that this could be done. Allen Feldman (1991) speaks of the corporal symbolism of the ethnic "other" in his monograph on violence in Northern Ireland. This process which he names "telling" can be related to Raja Nagar and implies receiving the body as an ideological text, and is used to maintain a social order represented through a demarcation of the other from oneself. This process involves the identification and association of bodily signs such as "clothing, linguistic dialects, facial appearance, corporal comportment, political religious insignia, generalised spatial movements and inferred residential linkages" (Feldman 1991:56-57). But as Feldman further contends, "telling" also organise the interaction with the ethnic others into orderings of reciprocity and separation which determine the quality of their contact.

While most Indian girls dressed rather conservatively in sarees and churidars⁷⁸, though with the exception of girls from larger South-Indian cities like Madras and especially Bangalore, many younger Sri Lankan girls in Raja Nagar preferred to wear so-called 'western clothes' like jeans and t-shirts. Rani, a 19 year old girl from Colombo said that: "*Indians look like they come from the jungle ... Sri Lankans dress modern, Indians wear *sabwar*⁷⁹ and sarees [...] Indians in modern dresses look very odd*". Mahadevi, Sivanesan's 23 years old daughter also emphasised this: "*Sri Lankans dress differently [from Indians]. It is not accepted [in India]. They (Sri Lankans) dress just like Western culture*".

Arachelvi was another young Sri Lankan girl in Raja Nagar. She was originally from Jaffna but had lived a long time in Colombo before coming to India. One day I was speaking with her, she was wearing white jeans, a red t-shirt and golden earrings. When I asked her about the way she dressed, stressing that few girls dressed like her in the city. She said, "*If you go to Madras or to Bangalore it is normal. Only Akhadipuram is backwards, it should be developed*". I asked whether people looked at her differently

⁷⁸ A Churidar is a tunic (*kameez*) worn over pyjama pants, tight from the knee down and loose from the knee up. It is tied at the waist with draw strings. It is often worn with a 'dupatta', a long thin shawl draped over the shoulders. Churidars were described to me as a relatively new type of clothing in Tamil Nadu.

⁷⁹ The *sabwar* is a loosely worn pyjama-like drawstring trouser, usually worn with a *kameez* on top.

because of the way she dressed. She answered, “*I don’t think so, Sri Lankan wear dress differently than Indians*”. She said that Indians don’t talk about her and other girls that wear modern clothes, but stressed that, “*they look differently at us [...] the city is like that, in Madras, people are doing their own things*”. I asked her if she perceived her self as a modern girl, she laughed and said, “*You have to ask the people in the area about that*”.

Some of these, what I would call more “modern” Sri Lankan girls, such as Rani and Arachelvi, still had family in Sri Lanka and Colombo whom they sometimes visited. Others had come from the island rather recently. As Colombo was more ‘westernised’ than for example Madras, their behaviour and dressing made them stand out in Raja Nagar. By Indians, Sri Lankan girls were sometimes described in almost mythical terms. Deva, one of my young Indian friends responded in this way on my question on whether he liked Sri Lankan girls: “*Oh yeah! They are very beautiful and freaked. They dress like foreigners, as if they have dropped from heaven*”. It is however noteworthy that Deva did not define Sri Lankans as ‘foreigners’. For him, foreigners were the same as westerners. People frequently associated different groups of people to various value systems, but common for all was their emphasis on the pre-eminence of their own value system compared to that of the other. In this context, the value systems were often linked to notions of the ‘traditional’ versus the ‘modern’ which frequently were set as dichotomised opposites. This can be seen in relation to Feldman’s (1991) argument about “telling” being organised around paradigms of ethnic purity and impurity. Negotiating pre-eminence either to the ‘modern’ or to the ‘traditional’ implies, I argue, a reference to notions of purity. The behaviour and respectability of women was used to denote and determine the moral character and integrity of a group of people, that is, their moral purity. In this process, dressing was a vehicles for determining or categorising a group of people. As stated afore, Sri Lankan girls were reputed to be more emancipated than Indians, due to which many acquired a bad reputation. Ambiga for instance said that Arachelvi had got a bad reputation in the neighbourhood because, as an unmarried girl, she had a lot of male friends and because she moved around a lot with a married Sri Lankan boy.

In a similar way, corporal symbolism was used to distinguish Jaffna Tamils from Colombo Tamils. Rani emphasised that girls from Colombo dressed more western than for example girls from Jaffna: “*Jaffna girls in Colombo pretend they are Sinhalese girls. If you are traditional (dress traditionally), army is catching [you]. Colombo girls are more modern; Jaffna girls are not like that. They are traditional*”. Selvaraj, one of Jeyadhani’s sons from rural Jaffna was however rather uncomfortable with the way many Sri Lankan girls dressed. He considered traditional

dressing more respectable: “*Sri Lankans dress different. Sri Lankans [have] so much of money, they wear costly dress, dressing like models. Girls in Indian families dress neat[ly], they wear old [fashioned] clothes. Sri Lankan girls dress bad, new fashion, foreign dress. I don’t like foreign dress [...] Saree is best, also thavani*⁸⁰. *Churidar, now only I like*”. Feldman argues that decoding the other also involves the encoding of the self, that is, by categorising the other, one simultaneously positions oneself in relation to the other. “Telling” thus emerges at the centre of the negotiation of identities with the other, and the prevalent sign systems regulate informal encounters between people of different groups. Signs are seen as connected to signified groups and predicates social relations into largely rule-bound situations (Feldman 1991). These prevalent sign systems must also be seen in relation to experiences as a foundation for recognising specific traits. With reference to Peirce’s sign theory; the bodily manifestations or expressions, which can relate to speech, dressing or other sorts of corporal comportment, which are the signs, produce ideas (interpretants) with the receiver (Daniel 1984). However, these interpretants are also the product of other interpreted signs, or former experiences if you like. When signs are recognised in the mind of the receiver with basis in former comparable interpretants, these may be seen as patterns, leading people to recognise Sri Lankans based on specific features.

SUMMARISING IDENTITY NEGOTIATIONS IN RAJA NAGAR

The Sri Lankans’ widespread social reclusion was by Indians often interpreted as an indication of the Sri Lankans’ involvement in suspicious and unlawful activities. But as we have seen, this was more fundamentally related to the dual factors of the repressive formations emerging after the assassination of Rajiv Gandhi and the recurrent problematic local relationship between Indians and Sri Lankans. Notions of differences based in experiences and stories from friends and neighbours were subsequently often linked to conceptions about primordial ties and given qualities. These are reproduced at the boundaries between groups (Barth 1969, Jenkins 1996), but also in what Schutz (1970) argues involves a process of ascribing an external group, not only specific qualities, but also certain positions to the world and to one’s own group. Schemes for interpreting the other rarely involve a search for reactions and responses to such stereotypes. In similar ways one commonly disqualifies the other’s perceptions when they don’t correspond to one’s own logic or dominant

⁸⁰ Thavani: Blouse and half-sari.

conceptions. This will place oneself in a relationship of dominance towards the other, and the other's knowledge will be subjugated one's own (Inden 1990). This may explain why discrepancies from stereotyped conceptions rarely are seen as anything else than exceptions and deviations from the norm, rather than actual challenges to these given conceptions.

The interpretive dimension is crucial to understand the construction of the other and people's negotiation of identities, whether this involve accentuating, concealing or manipulating certain traits or preconceived identities. But the sometimes substantial differences that people spoke of and which commonly were reflected in people's bodily comportment, general approaches and attitudes, and which were enforced by the violent transformation of the Sri Lankans after 1991, were not only the result of stereotypes and preconceptions and negotiations at boundaries. One should also associate these variations to certain more constitutive differences. As immigrants in the West tend to stick together though they are systematically dispersed by the authorities (see e.g. Roosens 1994), Sri Lankans tended to settle in places already densely populated by their countrymen. In a familiar locality, one does not have to transform or accommodate one's system of relevance to the one prevailing in the new group to the same degree in order to be accepted (Schutz 1970). Diversity can thus be related to certain cultural and societal formations, but also to embodied notions based in socialisation, class, origin etcetera.

This chapter should also be related to the transformation of the Sri Lankans in India after the assassination of Rajiv Gandhi. In this chapter, I have looked at constructions and negotiations of identities on local level. Indians and Sri Lankans in Raja Nagar operated with stereotyped and standardised representations of each other, but the Sri Lankans also rarely perceived themselves as a homogenous group. The large degree of internal variation was frequently based in origin and caste and on interpretations of historical events such as the disenfranchisement of the Upcountry Tamils and the violent uprising of the largely Jaffna based militant groups. Thus, as also argued in chapter two specifically and in general above, the understanding of present social practices in Tamil Nadu is impossible without considering these historical and broader regional and political contexts. Such differences were negotiated in various circumstances, depending on the identities that were negotiated at different times and in different contexts. In other circumstances, people felt ambiguous regarding the categories with which people operated, while they in other circumstances tried

to conceal or manipulate unwanted categorisations. These unwanted categorisations were usually related to the transformation of the Sri Lankans after 1991, when they came to be seen as a community of potential terrorists. I have sought to investigate how the Sri Lankans themselves construe and imagine the state through encounters with media and the local bureaucracy. The latter is frequently comprehended as a manifestation of the state on local level. The comprehensive experiences of corruption and extortion in encounters with bureaucratic institutions frequently resulted in the construing of the Indian state as repressive and corrupt. For Sri Lankans in general, the assassination inaugurated a period of difficulties. But rather than emphasising the state as a repressive entity, the local dynamics and experiences with the local Indian population, and vice versa, was usually presented as the reason for their problems. The frequent negative attitude towards the Indians seen in relation to former disruptive experiences strengthened the wariness many Sri Lankans felt towards the host population. Finally, certain traits, physical or bodily, would be used to identify various groups of people in Raja Nagar. Some of these were interpreted and used to ascribe the other specific moral qualities, which frequently devalue the other.

Mapping the processes of identity formations and negotiations which have been presented in this chapter is important for understanding the local effects of migration processes on people in Raja Nagar, the focus of the two following chapters. As we shall see, the extensive migration to the West among Sri Lankans families had a significant impact on local organisations and on the relationships between people in Raja Nagar.

Chapter 6 – Trans-national bonds and remittances

“...the seawater is salty because the tears of the sufferings of overseas Tamilians flowed into it”.

- C.N. Annadurai, former Chief Minister in Tamil Nadu. Quotation from DMK's homepage (DMK 2004.11.12).

INTRODUCTION

The context in which the Sri Lankans operated and interacted with the Indian host population should be extended beyond the location of Raja Nagar. Raja Nagar is a trans-national and multicultural locality, and not only do people from several nationalities, ethnicities and religions reside in the area, but people are also in constant movement to and fro this location. Many Sri Lankans have an extensive network of relatives living in the West from whom they receive commodities and money, and from whom they frequently receive visitors. As these relations have proven crucial for the economic subsistence of many Sri Lankans, I will investigate their effects on local living conditions and the relationships between Indians and Sri Lankans, and among Sri Lankans. I will however start by presenting Sri Lankan history of migration and different domains of settlement, before I engage in central theories on diaspora and migration. These issues are important for understanding the trans-national connexions that exist between Sri Lankans in India and those further abroad and the ways in which these localities influence each other.

DIASPORA AND MIGRATION

In the last chapter, I focused on identity formations and negotiations at people's place of residence. However, by having their attention centred on territory and local negotiations, theories on identity and ethnicity prove to be insufficient for understanding the notions of trans-locality and movement, which are of significant importance to understand the Sri Lankans' situation in India. By extending my theoretical focus to incorporate approaches on diaspora, my focus will include people's comprehensions of displacement, trans-nationality and adaptation and identity conceptions in a trans-local perspective. Secondly, as migration

theories are concerned with the reasons for movement and its effects on the centre and periphery, my approach will involve the social and economic impact of migration on local life. I will however begin by presenting historical characteristics and settlement patterns of the Sri Lankan diaspora. Significant formations that relate to time and place of migration will reflect local economic and social patterns. It may for instance shed light on why certain families in India and Sri Lanka live well on remittances, while others struggle.

THE SRI LANKAN DIASPORA

Sri Lanka has a long history of migration. Before colonial rule this was related to religious organisations and affiliations, trade, warfare, and import of persons for marriage, labour and for military purposes. These movements were not restricted to India only, but also to more outlying regions such as Burma, Thailand and the Middle East (De Silva 1981, Ludowyk 1962, Tambiah 1986). During colonial reign, and principally during the Raj, many people from the upper stratum of the Ceylonese society moved to the West for education, where many also settled (Daniel and Thangaraj 1995). As we know, there was also an extensive import of Tamil labourers from India to the tea-plantations in the Sri Lankan hills. During the later parts of the 20th Century, many of the stateless Upcountry Tamils were also “repatriated” to India. In the 1970s many Sri Lankans, especially of Muslim and Sinhalese origin left as labour migrants for the Middle East (Eelens and Speckmann 1990, Rødseth 1999).

Sri Lankan migration

The escalation of the conflict in Sri Lanka brought about a wave of emigration after 1983, resulting in a widely dispersed Sri Lankan population. By the 1990s, some 200,000 Tamils had fled to India (Amal Raj 1997). With the exception of certain interludes with relative absence of fighting, and in spite of the continuous flow of people in and out of the country, this number has remained more or less stable. Approximately 300,000 Tamils have settled in North America (primarily Canada) and Europe (Cheran 2001, Van Hear 2000), and around one million Tamils, Muslims and Sinhalese are believed to have been internally displaced (Amal Raj 1997, Van Hear 2000). Cheran (2001) also claims that out of a Tamil population of two million in 1981, $\frac{3}{4}$ were by 1995 either internally displaced or had sought refugee status abroad. As a result of the Sri Lankan Tamil diaspora, Toronto is today the city with the largest Sri Lankan Tamil population, surpassing Jaffna.

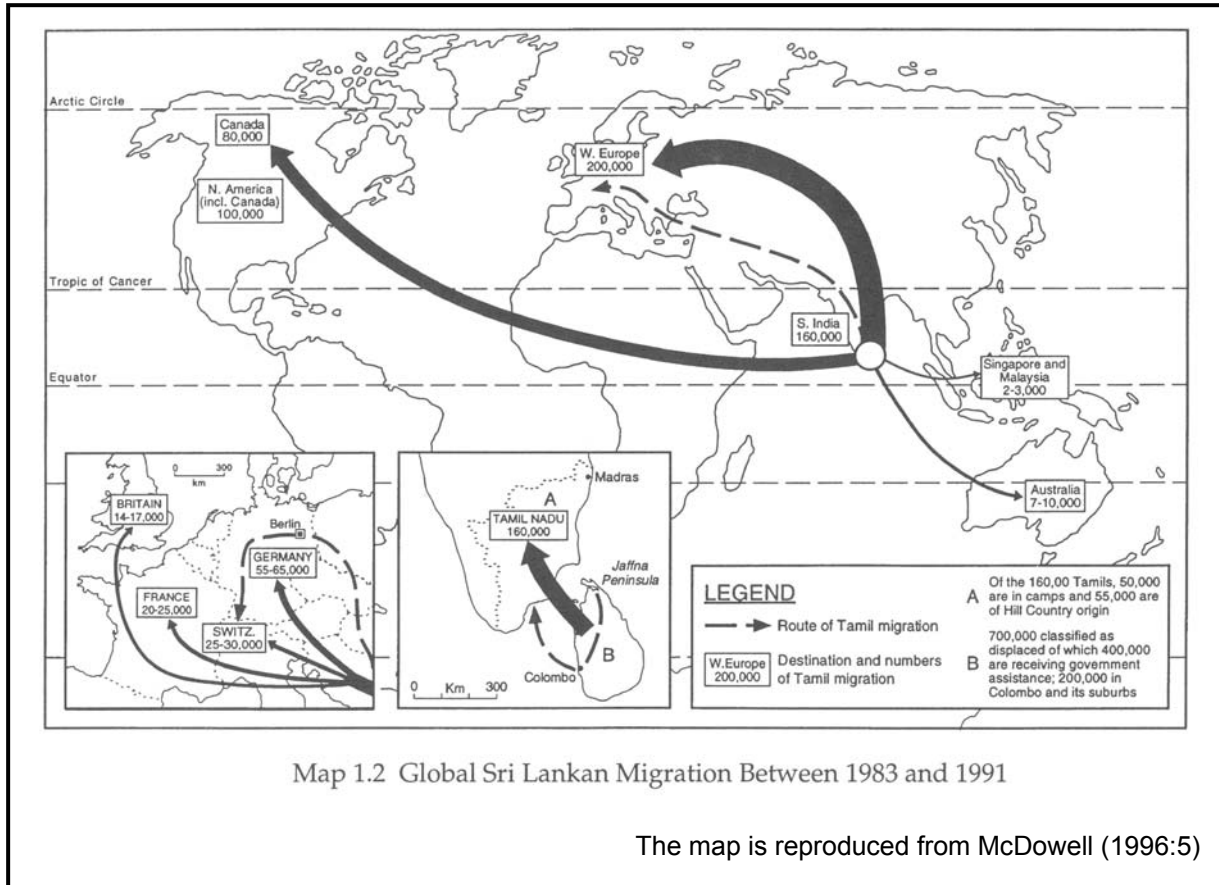

Tamil Nadu was initially the prime destination for many Sri Lankan Tamils due to the low travel cost and the support expressed by the Indian Tamil politicians and population. The Indian state was also attractive for Tamil militants due to India's extensive military and economic support in the early 1980s. In spite of India's gradual changing political approach towards the Sri Lankans, the influx of Sri Lankan Tamil refugees persisted. The growing problems in India however led to an increase in migration to Western Europe and Canada, where also LTTE established themselves and started organising their activities after being banned from India. Some of the countries which received the largest share of Sri Lankan asylum seekers were Canada, the UK, Switzerland and Germany. The existence of a Sri Lankan community in western countries like the UK, facilitated the movement and social adjustment of these war-affected Sri Lankans (Daniel and Thangaraj 1995).

While Britain had a well established Tamil population before Sri Lanka's independence (Daniel and Thangaraj 1995), the first Tamils migrants to other countries started later, e.g. in Norway and Canada in the late 1960s and in Switzerland only after 1983 (Cheran 2001, Fuglerud 1999, McDowell 1996). Initially, many of the poorer and low class- and caste

migrants or refugees fled to the nearby Indian state of Tamil Nadu due to the low travel costs, while people of mostly high-caste and middle class origin, started settling in the West. When the conflict emerged, these communities in Europe assisted relatives and friends to migrate, helped recent arrivals through the bureaucratic system and introduced them into the labour market where they themselves had worked for many years (Daniel and Thangaraj 1995, McDowell 1996). While the earlier migrants were of high caste and class backgrounds, many of the later refugees were from the lower ends of the caste and class spectre and which had a radically different demeanour from the former migrants. In Britain, this led to conflicts within the Tamil community, where the influential early migrants struggled to preserve a traditional caste/class based social order. They considered the refugees a threat to their conservative values⁸¹. The later migrants took blue-collar jobs, for instance at petrol stations and invested money which they either sent home to their families or used to pay their kinsmen's way out of Sri Lanka. Discords between different 'vintages' of migrants frequently emerged alongside class and caste frictions. 'Vintages' refer to dynamics within migrant communities where tension often surfaced between people who migrated during different periods relating to the political situation in Sri Lanka (Fuglerud 1997, 1999). Identification with a specific vintage involves a political and moral justification for leaving the country at a specific time. They are based on a group identification founded in what Fuglerud labels 'destiny groups'. Such justifications frequently include scepticism towards people who either departed before, or who stayed on longer than themselves. The identification with a specific vintage was an important basis for relations of equality and mutual acceptance, and for friendship and daily association. With the gradual tightening of British immigration laws⁸² many of the later migrants accumulated excessive debts as the use of expensive illegal agents now had become imperative for getting to Europe. Poor families who had sold their houses and properties in order to get a relative to Europe could end up with debts which they were unable to repay due to the exuberant travel costs. Such problems could make it increasingly difficult to integrate into the economy and for people to subsist on their earnings (Daniel and Thangaraj 1995, McDowell 1996). This also affected their kin in Sri Lanka or relatives who

⁸¹ Daniel and Thangaraj (1995) state that the established Tamil population of Sri Lankan origin found it hard to see Tamils as refugees. They expected them to conform, to take their advices, to turn to education and to move up in the British society – as they had done – but they were let down.

⁸² Britain is an interesting example. In 1993 many of the European countries harmonised their immigration laws (after the Schengen accord in 1990), as a result, 76% were granted Exceptional Leave to Remain (ELR) in the first half of 1993, while only 22% were granted ERL in the second half.

resided in India, as remittances could be reduced and as their possibilities for migrating to the West became more limited.

The social and hierarchical conceptions and values of the early high-class and class Tamils in the West were gradually challenged with the emergence of the conflict and the influx of refugees. The war and pro-LTTE political inclinations of the later Tamil migrants generally led to the emergence of a political preponderance for revolutionary ideologies before traditional values in many western countries (Fuglerud 1999). While the upper-class and caste community in Britain were well-established and were largely able to maintain their position, the earlier migrants were more politically marginalised in Norway. The later migrants in Norway did gain great legitimacy by virtue of having been victims or participants of the war. Moreover, the arrival of immigrants from opposing militant groups in the 1990s led to conflicts and suspicion within the Tamil communities, as they challenged the authority of the Tamils who supported the LTTE (Daniel and Thangaraj 1995).

Diasporic domains

The Sri Lankan Tamil diaspora can thus be divided into three domains of settlement, broadly speaking, along geographical, economic and cultural lines. The first domain represents the country of origin which in this case is Sri Lanka; the second is the neighbouring country or the country of first asylum – India; while the third is what Nick Van Hear names the wider diaspora, which is the country of final settlement (Van Hear 2003). The association between such diasporic domains may be strong or weak or may vary over time (Cohen 1997, Van Hear 2003). In the Sri Lankan context, these have generally persisted due to strong family bonds, expectations and obligations that transcend these national boundaries. These domains are associated through a constant flow of people, money, resources and information. In addition, trans-nationalism and the collection of funding from the Tamil diasporic communities, of which the LTTE are highly dependent of for purchasing modern weaponry to rival the SLA, have also sustained these relations (Cheran 2001, Daniel and Thangaraj 1995, Davis 1996, Fuglerud 1999, McDowell 1996).

Relating especially to the economic and social dimension of the diaspora, I argue for the existence of significant sub-strata within some of these domains. Both in Sri Lanka and in India, the internally displaced (IDPs) in the so-called Welfare Centres in Sri Lanka and the

refugees in camps in India live relatively separated from the local communities. Their possibilities to move or work outside their camps vary, but are often limited, and their contact with people living the local communities may be only sporadic (Refugee Council 1999). The greater parts have been severely affected by the war. Many have lost all their properties and belongings, and had to abandon their homes hastily when their villages suddenly were embraced by the war. Many ended up in the Welfare Centres in Sri Lanka, while others who managed to flee to India ended up in the refugee camps. These people are frequently unable to sustain themselves economically outside the camps, and are dependent on government funding or help from NGOs. They rarely have relatives abroad who can support them financially to attain a better life outside a camp location, or to leave the island or India for better economic prospects. In other words, the likelihood for an improved life situation is small.

The third domain representing the wider diaspora or the countries of resettlement can broadly be divided between the Gulf States or countries in the Middle East and Western countries. As I described above, differences between migrants to the Middle East and the West in general relate to the Sri Lankans' ethnic origin and class, as well as their reason for migrating. The Sri Lankans who travel to the Middle East mainly go as labour migrants. They are also primarily Muslims and Sinhalese, and to a lesser degree of Tamil origin. They are regularly from the economically poorer sections of the Sri Lankan society who rarely can afford the costs of going to Europe (Van Hear 2000). The Sri Lankans leaving for Western Europe or Canada currently largely go as asylum seekers, but usually with the additional pretext to improve the general situation of their families by means of remittances. While journeys to the Gulf-states predominantly are 'legal', migration to the West are frequently carried out with the help of illegal agents and are often exceedingly expensive. The economic and material prospects, as well as the living conditions are generally higher in the West than in the Gulf-states.

DIASPORA

The notion of diaspora is commonly associated with the settling of scattered populations outside their original and sometimes removed homeland, and with the connexion that exist between this scattered population across national boundaries (Anthias 1998). As we saw in the previous chapter, the notion of ethnicity primarily focus on inter-group relations within

bounded territories. It does not facilitates a focus on the importance of trans-national ties between migrants, their counties of origin and the countries of settlement, as well as the identity production that may develop from such ties. As these are important representations of the Sri Lankans' situation, the need for a transitional concept like diaspora emerges as an important addition to theories of ethnicity. Theories on diaspora transcend the rigid focus on discrete national dynamics and refocuses attention on trans-national and dynamic processes relating to diversity within ethnic groups across nation states. It opens up for flux and movement, travel and trans-nationalism (Manger 2001). Diasporas have traditionally been associated with a wide range of peoples such as the Jews, the Armenians and the African descendants of the slaves, but also with other dispersed populations like the Greek, Indians and Chinese (Cohen 1997). Today, this notion has experienced a great inflation, and is frequently seen to embrace more than 50 different peoples (Dufoix 2001). Migrated populations from Asia, Africa and the Middle East have encountered a range of challenges in their new homelands in the West. These are often related to problems of integration, conflicting moral values with the host populations and problems with discrimination on the labour market (see e.g. Gardner 1995, Roosens 1994). But intra-familial tensions and conflicts between different generations are also frequent as we have seen among the Sri Lankans in India. Generational conflicts has been emphasised by for instance Fuglerud (1999) in the context of Sri Lankan Tamils in Norway, among immigrants in Belgium (Roosens 1994), but also in a range of fictional literature such as Zadie Smith's "White Teeth" and Hanif Qureshi's "The Buddha of Suburbia". Generational disputes are often related to gender roles and divergence between traditional values and the values of the host communities. The value system of the host communities may be represented by a greater liberty regarding general behaviour, dressing, marriage etcetera. As a strategy to overcome such problems, Kårtveit (2003) has argued that Palestinians living in the U.S bring back the younger generation to maintain their bonds to the West Bank, and to preserve the traditional family structure and their cultural practices. In other contexts, the opposite may occur. The younger generation may adopt and stress a radically more conservative cultural notion than their parents, and resist any identification with the local population (Roosens 1994). Diaspora communities may also be of great significance for the political stability in the state from which they have left. In Sri Lanka, the massive financial support to the LTTE from the Tamil diaspora in the West has undeniably prolonged the conflict. Another example is the Iranian diaspora in Europe which was responsible for overturning the Shah regime in the late 1970s.

Floya Anthias (1998) draws attention to three different approaches to the notion of diaspora. The first, asserted by Safran (1991) and Cohen (1996, 1997) is an objectivist and descriptive representation of people displaced from their place of origin. Their shared displacement and perceived natural and primordial bond to a common place, and the common aspiration of return associate these people. Safran and Cohen's approaches may be seen in relation to Anderson's (1996) argument about imagined communities. Members of a nation may only know a few other members of the "same nation", but nevertheless identify themselves (or 'imagine' themselves) as being part the same community. Safran (1991) imposes a set of criteria in order to establish whether a community can be deemed diasporic. Safran points out six criteria that defines diaspora-communities. He sees diaspora as "expatriate minority communities"....:

1. who are dispersed from original "centre" to at least two "peripheral" places
2. who maintain a "memory, vision, or myth about an original homeland"
3. who "believe they are not or cannot be fully accepted by their host country"
4. who see their ancestral home as a place of eventual return – when the time is right
5. who are committed to the maintenance or restoration of this homeland
6. who's group consciousness and solidarity are "importantly defined" by the continuous relationship with the homeland (Safran 1991:83-84)

Cohen (1996) seeks to maintain an objectivist definition found in a classical notion of diaspora from the book of Deuteronomy and the Jewish exile in Babylon. But he also incorporates modern and global aspects arising from people's mass-movement and what he sees as a slow decline of the nation-state. He includes other forms of diasporic experiences, such as victim, labour, imperial, trade and cultural diasporas (Cohen 1997). Though his representation offer a broadening of the term from Safran's, it nevertheless implies a rigid definition of what a "real" diaspora is and thus excludes large numbers of people who do not fulfil the "necessary requirements". The objectivist approach does also not account for the large variations among a diasporic population regarding their "attachment" to their "original centre" and the degree of integration in the host country. The Upcountry Tamils are interesting in this context. As we have seen, many of them consider India to be their country of origin, but identify themselves as Sri Lankans. The Tamil diaspora is variously spoken of as representing the Tamil population *in toto*, that is, Indian or Sri Lankan origin is made irrelevant (see e.g. Tamilnation 2005.02.08). While in other contexts, nationality is

demarcating a difference between various overlapping diasporas, for instance Indian (Cohen 1997, Ghosh 2002), Indian Tamil, Sri Lankan (Van Hear 2003) or Sri Lankan Tamil diasporas (Cheran 2001, McDowell 1996). Furthermore, I argued in the last chapter that there were noticeable differences with regards to integration between people who lived in a place like Raja Nagar with high concentrations of Sri Lankans and places with few Sri Lankans. There are also great variations based in origin, experiences and between generations.

The second view is asserted by post-modernists such as Clifford (1994) and Appadurai (1991). It emphasises “routes instead of roots” and is preoccupied with a creative mingling of culture in a world where cultural boundaries are fluid. Identities are constructed on a world scale, instead of within the borders of a nation state. According to this view, everybody live in a common cultural universe which transgresses national and geographical boundaries. This challenge the nation state as a form, and identity becomes more syncretic, trans-ethnic and trans-national. It is also opposed to the former approach by viewing diasporas as challenges to ethnicity and ethnic absolutism, and focus instead on hybridity (Clifford 1994). Appadurai (1991) argues that people today live in an increasingly cosmopolitan, trans-national and deterritorialized world. Due to the influence of mass media, people today consider a wider set of possible lives than before. This has triggered the power of the imagination, producing images, ideas and opportunities from elsewhere. He argues that while the idea and the possibility of movement earlier were limited to specific groups of people, it is today open to more people. But as such information is not equally accessible to all, people’s possibilities for imagining other potential life-situations also necessarily vary. This argumentation fails to take into account the cultural, political and economic challenges related to migration and settlement in a new place. While the willingness to move to the West seems to have increased after 1991 among the Sri Lankans in India, their possibilities for moving have simultaneously decreased, especially among the poorer segments. This is mainly due to stricter immigration rules in Europe, but partly also due to the large expenses involved in using agents (see e.g. Fuglerud 1999, Van Hear 2000) and corruption in the Indian immigration system. These expenses do not seem to have hampered Tamils from migrating to the West, but has instead resulted in increasing travel-costs to Europe, making it more difficult for poorer people to leave for Europe. Generally speaking, this view overestimates the freedom people have to make their own decisions and to improve their situation. This aspect will be elaborated further in this chapter and the chapter to come.

The third perception, which Floya Anthias (1998) adopts, pays more attention to the intersectionality of various processes, extending beyond the notion of trans-national movement. It views diaspora as a field where multiple parallel and crossing identities and processes of categorisation act simultaneously. It opens up for local complexity and contradictory processes (Manger 2001). In this context, gender, class, age and power relations are subjects of change, both within the group as well as in relation to the host community. A diaspora identity emerges in the encounters and interplay between various loyalties, and people may have varying conceptions of what their diaspora identity implies. As we saw in the last chapter, conceptions of belonging may diverge depending on context and between people. The fluidity regarding people's sense of belonging is, as described in the former chapter, probably no more apparent than among the repatriates or Upcountry Tamils in India. Identity markers among my Sri Lankan informants implied a variety of notions such as nationality, the idea of Tamil Eelam, that of being a Tamil, place of origin or 'ur', caste, class or gender, while in some contexts it could be a combination of many. As argued above and in the last chapter, one should speak of a set of identities, varying in significance depending on context and on people's intersubjective self-conception at a specific time, and not about one diaspora identity. Furthermore, construing a diasporic identity may involve not only a concrete history, but also collective and individual memories and narratives (Manger 2001). As Appadurai (1991) argues, localities are brought closer by the use of technology. This is apparent by the extensive use of internet and telephone connecting kin living in different countries, as was evident in Raja Nagar, but also from LTTE's information and cultural enterprises. By means of internet, own weekly newspapers, radio- and TV-stations, the organisation reach out to the diaspora communities and distribute not only political information, but are also engineering a comprehensive cultural production. They distribute propaganda videos and recordings of victorious battles with glorious prophecies of the imminent establishment of Tamil Eelam (Cheran 2001, Davis 1996). Certain cultural notions may however be seen as basic for being accepted as a part of a migrant community (Roosens 1994). Among the Tamils, this may be related to notions of kinship, language and to family structure.

MIGRATION AND MIGRATION THEORIES

Theories on migration concentrate on the movement of people between different geographical domains. They are concerned with people's motives and reasons for moving, as

well as the implications for the sending and receiving communities. People's have their perspectives shaped by mixing external cultural forms with personal experiences and interests (Hannerz 1989). In a broad sense migration concerns the interconnectedness of lives lived in different places. Kearney (1986) presents three theoretical approaches on migration: modernist, dependency and the post-dependency theories of world-system theory and articulation theory.

The modernist view can be seen as urban-centric, as it postulates a dualism between the city as developed and modern versus the countryside as underdeveloped and traditional. In its emphasis on the relation between the sending and receiving community, it focuses on the individual rational decision makers. The modernist perspective regards migration as a strategy to provide and invest capital and knowledge acquired from the location of migration back to the home country, region or community. These investments are ultimately believed to lead to local development and economic growth (Barfield 1997, Kearney 1986). A perspective on the consequences of migration at the periphery is important as it shed light on the local economic consequences of remittances among my Sri Lankan informants. However, research on migration-based households and return-migration shows that labour migration often fail to bring about growth and development in migrant-sending communities (Kearney 1986). This is, as we shall see, also the case in Raja Nagar. Remittances are often be spent lavishly, instead of being invested in local projects or community development (see also Kårtveit 2003).

Dependency theory which represents a neo-Marxist critique of the modernisation perspective has a fundamental contrasting approach. Instead of regarding migration as benefiting the sending communities, it argues that migration from the rural to urban centres de-develops and drains economic surplus and human capital from the peripheral areas (Barfield 1997, Kearney 1986). Contrary to the modernists' argument of two cultural realms – the modern and the traditional, dependency theorists postulate a single world capitalist system. The rural and the urban core are inter-connected, and are seen as linked together by ties of dependency serving the developmental needs of the centre. This is effectuated by the constant flow of economic surplus and human capital from the periphery to the core, of which brain drain from the Third World is but one example. Therefore, and differently from modernisation's ahistoric, individualistic and microeconomic approach, dependency theory theorises historic macroeconomic relationships (Kearney 1986). However, while dependency theory

perpetuates the indispensable argument of inter-connectedness between the different fields, it is less concerned with the flow of remittances to the periphery – this being a crucial aspect in my field. Dependency theory also theorises less on dynamics in urban labour markets and their relationship to the sending communities, and does also not account for the great variety of reasons for migrating. As stated afore, Cohen (1997) mentions a number of “different” types of diasporas; victim, labour, imperial, trade and cultural. Though this represents a somehow rigid characterisation of a “real” diaspora, it nevertheless shed light on various causes for the movement of people. The Sri Lankans’ motives were complex. It was of course related to the flight to safety from the armed conflict on Sri Lanka, where many had lost not only loved ones, but also most of their possessions and properties. But it also had a strong socio-economic dimension, that is, to improve not only their own situation, but also to safeguard the subsistence of their households, relatives and kin in India and Sri Lanka, many whom were dependent on these remittances to live. Furthermore, migration could be vital to fulfil social and familial expectations and obligation such as securing the dowry or organising the marriage for a sister.

Later, two post-dependency orientations developed: the world system theory and articulation theory. The former is an offspring of dependency, and propose a global system, emphasising an international division of labour and an exchange of commodities among different zones of production and consumption. Theoreticians postulating this view examine the seizure and transfer of surplus from the peripheral to the core area, and that it is the centre which profits from this transfer at the expense of the periphery (Fuglerud 2001). But differently from its forerunner, the world system theory analyse rural migrant labour in core areas. Kearney (1986) argues that the world system theory has a greater relevance to migration studies as migrant labour to a greater extent is theorised within the complex problematic circuits of capital and commodities. It can for instance be used to situate a local community within broad historical and structural contexts. Critique of this view emphasises that migration flow and migration theory in general tends to be cast behind a political-economic guise. Another is that it represents a withdrawal from the cultural, that it ignores people’s perspectives at the peripheries (Hannerz 1989). It also fails to account for human creativity, activity and resistance (Fuglerud 2001).

Consequently, a new anthropological approach to migration and development emerged. Articulation theory, as it was called, aimed not only at retrieving the focus on culture within larger historical contexts, but it simultaneously sought to transcend the psychologistic limitations embedded in a modernist approach, while it sought to examine relationships of dependency (Kearney 1986). Articulation theorists argue that distinct non-capitalist modes of production often are preserved and sometimes also produced by integration with capitalism, for instance by migration between two such spheres (Barfield 1997, Fuglerud 2001, Kearney 1986). In other words, it argues that peripheral communities are different regarding their economic dynamism. They reproduce their distinct forms in accordance to their own structural imperatives. It also claims that an analysis on the appropriation of surplus must be based at the locations where its production is generated (Kearney 1986). Articulation theory thus rejects the existence of a unitary global capitalist system, championed by dependency theorists. This approach allows us to take into account both the local and economic dynamics in Raja Nagar, and the trans-national remittances that economically sustain many Sri Lankans. Most of the Sri Lankan households in India subsist by a combination of various economic activities.

MOVEMENT AND SETTLEMENT

The war, diaspora, and the wide ranging settlement patterns have influenced the socio-economic situation of the Sri Lankans. But before engaging in a discussion about these consequences on the local people in Raja Nagar, it is necessary to locate structural patterns of Sri Lankan settlement in Tamil Nadu. In this context, I wish to present two significant distinctions relating to this settlement. The first is between the Sri Lankans who live inside and outside the refugee camps. The second concerns the Sri Lankans outside, and is between those who have relatives in the West and those who have not. In both these cases, variations are largely geographical, caste- and class-based. Each of these fields are largely represented by different economic and material possibilities reproducing and enforcing an already existing diversity within the Tamil diasporic community in India.

SETTLEMENT PATTERNS, ORIGIN AND SOCIAL DIVISION IN INDIA

Differences existing among the Sri Lankans regarding their socio-economic status, level of wealth and possibilities for wealth acquisition are generally reflected in their settlement patterns. People in refugee camps are predominantly from the poorer sections of Sri Lankan

Tamil society who cannot afford the cost of living in the local communities. Bastiampillai (1996) refer to a study conducted in 1985, which indicated that the large majority of the camp inmates were from Mannar and the Hill Country. According to several informants who worked in various NGO's⁸³, this pattern still seemed accurate. The majority of the camp refugees were predominantly of lower castes, and came from areas like Mannar, Vavuniya, Mullaittivu, Kilinochchi, Trincomalee, Batticaloa, rural Jaffna, and the Hill Country. They were generally from the more destitute parts of Sri Lankan society. Suryanarayan and Sudarsen (2000) estimate that 30% of the camp refugees are Upcountry Tamils of Indian origin, who frequently represent the poorer and lower caste sections of Tamils in Sri Lanka.

Comparatively, the above-mentioned study conclude that the majority of urban, white collar Sri Lankan Tamils were residing outside the camps and were predominantly from Jaffna, Colombo, Kandy and Nuwara Eliya. The Sri Lankans living in the local communities like Raja Nagar today are frequently from the Jaffna peninsula; principally from Jaffna itself, its near rural surroundings, and from the northern coastal areas as Point Pedro and Valvettithurai. In addition, many came from Colombo, and some came from the Hill Country. The two latter categories are thus often overlapping, as many of my informants from Colombo, as Sivanesan and Ramaswamy, originally came from the Hill Country. Furthermore, and again in contrast to the camp refugees, few people were from the east coast and areas and towns like Mannar, Vavuniya, Kilinochchi and Mullaittivu. The Jaffna Tamils that I met in Raja Nagar or in other local communities were exclusively Vellalas or Karaiyars. A prominent difference between the Sri Lankans in the local communities and the camp refugees were not only their backgrounds, but also their possibilities for accumulating wealth. Getting work could be difficult for the camp dwellers as their movements in and out of the camps often were restricted and sometimes difficult due to the camps' remoteness. Not only was movement trouble-free for the people in the local communities, but many Sri Lankans, especially those of Jaffna origin also had extensive family networks in the West. These relatives often supported their kin in India and Sri Lanka with money and commodities, and sometimes also helped them to migrate to the West. The level of wealth was thus generally higher among people with trans-national bonds than among those without. The numerical

⁸³ Many of these people wanted both themselves and their organisation to remain anonymous to avoid problems with the authorities. Many had already experienced arrest, harassment and severe forms of interrogation due to their work with Sri Lankan refugees. None of these people were however supporters of the LTTE. They were scared that sensitive information, with them figuring as sources, would be made public.

dominance of Jaffna Tamils in Raja Nagar who had relatives in the West is echoed in McDowell's (1996) study. He presents statistical data showing that out of a sample of 504 Tamil asylum migrants that came to Switzerland between 1983 and 1991, 454 came from the Jaffna peninsula⁸⁴. People from Jaffna Administrative District also outweighed people from other areas in the Northern Province, as Vavuniya, Kilinochchi and Mullaittivu for instance⁸⁵. Both Fuglerud and McDowell's material show that certain areas or villages of origin are dominant among migrants to Norway and Switzerland respectively. This reveals the importance of kinship ties or sometimes only place of origin for one's possibility to migrate to the West.

The level of wealth and the possibilities for wealth acquisition is in other words an important marker of difference between people regarding the possibility for migration. As we shall see, stricter immigration rules in Europe have not obstructed people's possibilities to migrate to the West, the need for illegal agents has only made it more expensive. It should be added that Sri Lankans' possibilities to earn money in India were not only fewer than in the West, but they were also further restrained with new laws and regulation barring the Sri Lankans' access to government jobs and education after the assassination of Rajiv Gandhi. With economic resources becoming more and more defining for people's ability to migrate, already existing differences with regards to economy are further increased.

INCENTIVES AND MOTIVATIONS FOR MIGRATION

Van Hear (2000) notes that the initial reason for going to Europe among the refugees was forced migration, but that this commonly transmuted into, or merged with other forms of movement. It is crucial to view the Sri Lankan diaspora and processes of migration in the light of a complex set of incentives that transcend the notion of forced migration or that which is purely economically motivated.

It should however first be noted that, in addition to own economic sustenance and saving money for a later life in Sri Lanka, such incentives usually included material and economic

⁸⁴ This number represent a little more than four percent of fully-adjudicated applications (504 out of 12,630) submitted from 1983 to 1991, and two percent of all applications submitted. The remaining numbers are; Colombo: 20, Eastern Province: 15, Other: 15 (McDowell 1996:123).

⁸⁵ More specific, 88% came from areas encompassed by the Jaffna Administrative District; 2% from Kilinochchi; 4% from Colombo; 2% from Mullaittivu; and 4% from Trincomalee, Batticaloa, Kandy, Vavuniya, Mannar and Amparai.

support of relatives in Sri Lanka or India. For families with migrant relatives, financial remittances ensured a certain standard of living during the politically turbulent and uncertain times, without which many would find it hard to survive. Other familial expectations and demands were interrelated with migration and economy, such as paying back debts procured when financing one's journey; earning to finance dowries for marriageable sisters; financing and supporting economically journeys for other relatives; and financing one's own marriages. Finding work and earning money is therefore crucial for the migrated Tamils in order to fulfill their many financial expectations and demands. Tamils in the West have thus often gained the reputation for being hardworking and reliable employees (Daniel and Thangaraj 1995). These formations must also be seen as related to caste, class and kinship in a broader sense. Marrying someone living in the West is highly desirable among Sri Lankan Tamils, as this usually provide one a residence permit to a western country. Marriages are usually arranged 'traditionally' by parents and, with someone of similar caste and class background, and frequently preferably with marriageable cross-cousins. Hence, the economic aspect should not be separated from family expectations and obligations, which together maintain the trans-national family-relations. It should be added that for many Tamils in Sri Lanka, migration, both to the West and to India may be an alternative to fighting (Fuglerud 1999). The LTTE usually demand one member of each family to become a fighter and many of the internally displaced have thus not only fled fighting and SLA shelling, but also forced subscription by the LTTE.

While this chapter deals more with the economic and structural patterns of Sri Lankans' migration and settlement in India, and the local formations related to dispersion, migration and economic sustenance, the next will have to do with the social, familial and actual processes of migration. As economy and family expectations are so closely interrelated, matters related to family expectations should not be let out of this chapter.

TRANS-NATIONAL BONDS AND LOCAL FORMATIONS

Sri Lankan migration and its implications on the local Indian communities, such as Raja Nagar, should be explored on a number of different levels. First, it is important to give a presentation of different families and their kinship networks, as this will reveal significant patterns of dispersal and trans-national settlement and thus the familial complexity represented by having such bonds. It is subsequently necessary to identify and examine

formations on local level which relate to differences between various Sri Lankan families with relatives abroad with regards to wealth and trans-national influence. This will be approached by looking at Tamil migration historically, by considering the possibilities and the travel expenses connected with migration over the last 20 to 30 years. In addition to the impact of migrant remittances, it is important to investigate local forms of economic sustenance. This will incorporate the Sri Lankans who do not have such bonds, and also grasp other dimensions of wealth productions which are of significance for the Sri Lankans with relatives abroad. Finally, the local consequences should be elaborated thoroughly by focusing on the local economy, investments and how the local Indian populations respond to the effects of the Sri Lankan trans-national economy. This will be done while considering various migration theories presented initially in this chapter.

DISPERSAL AND TRANS-NATIONALITY

As initially stated, the degree of dispersal in Sri Lankan families could be rather extensive. One of Sivanesan's friends from Jaffna had for instance all his five brothers and sisters in different countries: Canada, Saudi Arabia, Sri Lanka, Australia, Singapore, while he himself lived in India. The degree of dispersal within families was reflected by observing people's kinship structure. I have chosen to present three families, Sonali's, Jeyadhani's and Rajkumar's. A detailed representation of their family ties can be found in the appendices. The two former are Karaiyars from Jaffna, while Rajkumar was an *Asari*, a goldsmith jati, from Eastern Sri Lanka. Though I have chosen only to present three such maps in this dissertation, they reflect a pattern among the Sri Lankans in Raja Nagar, namely that people of Jaffna origin had an extensive family network in the West, which generally deviated from the kinship structure of people from other places. I have found it superfluous to include a cluster of their maps as very few of my informants from Colombo, the east or the Hill Country had any significant number of relatives abroad. I will start by presenting Sonali and her family and continue by presenting aspects of Jeyadhani's family which relates to trans-nationality.

Sonali and her family fled from her small fishing village close to Point Pedro when the SLA inaugurated their assault on the Jaffna peninsula in 1995. She told me; "... *Everybody left the village. Some thieves are living there now [...] in my village, 30 people, all relations, died in LTTE. 300 people in village, 1 km of road, 10% of all died*".

Sonali came to India by boat in 1996 and was now living in Raja Nagar together with the family of one of her brothers. She told me she had problems with the Indian authorities when arriving in India due to her background from Point Pedro. She said that she was "...*subject to enquiry, but released from Mandapam*". At the time of my fieldwork, she was about to move to the UK where five of her eight children were

living. Two of her other children had been killed while they fought in the LTTE. The last one left the movement in 1994, but was abducted by the SLA the following year and is still missing.

“In [...] 1995 he went [back] to our village in boat with Maran (Sonali’s MBS) to get things, onions. [...] Army stayed in Vettalaikerni camp. The boat with Raghavan (Sonali’s son) was shot at, but he survived. He was arrested. He was put in hospital, then imprisoned. We informed to ICRC⁸⁶. [...] My sister’s husband informed: ‘no news’. We stayed in Pattukuddiyiruppu in Mullaittivu until 1996, then we came to India. I have no news about my son. We informed Human Rights groups, British research, we have no news. One told he was in Boosa camp in Galle in 1998. I think he is still alive. [...] In his horoscope it says, in 5-6 months, he will come out, after June. I believe that”.

She had detailed knowledge about how and in which battles her closest relatives, including her two children, had been killed. The LTTE always informed them well about the circumstances and dates in which they were killed. In addition, she had also lost one of her brothers to random shooting by SLA soldiers. He was shot in the chest while holding his then two years old daughter. The bullet went through her hand before killing him, leaving Sonali’s nieces with a star-shaped scar in her hand.

As is reflected in her kinship map, Sonali’s extended family was represented by a vast record of settlement patterns. She had comprehensive information about the whereabouts of almost all her closest relatives. She was only unable to locate two female relations. In her account, her close relatives consisted of 88 people. This included her siblings, their spouses and children, and also some of her siblings’ grandchildren (see appendix four).

Among these people, 15 have been or still are in the LTTE. Eight of these are dead; one is in a special camp in Tamil Nadu; while her son as described above disappeared in Sri Lanka after being captured by the SLA. Five are still active in the movement. One non-LTTE family member was killed by IPKF and her brother by SLA random shooting. She has a range of relatives in Europe (32); outside refugee camps in India (18); inside regular refugee camps in India (5), as well as the one in the Special Camp, while 16 were living outside camps in Sri Lanka, but they were all internally displaced. Sonali’s native village is now under SLA control, and her relatives in Sri Lanka live in LTTE-controlled areas, in Mullaittivu and in the Vanni.

Jeyadhani’s family had also been severely affected by the war and were widely dispersed. They fled to India with boat in 1990 after fighting emerged between the LTTE and the IPKF. They lived in a refugee camp for one year before settling down in Akhadipuram. Jeyadhani has seven children, where the four eldest (three boys and one girl) now live in different countries in Europe. Jeyadhani’s husband had a small job and earned about 2,000 INR per month. Besides that, they received money and some goods from their sons in Europe. This money was invested in domestic items, such as furnitures, electric goods and other commodities. The amount of remittances from Jeyadhani’s sons had however decreased during the last few years. I was told that they were struggling to support themselves in their countries of residence. Most of her relatives had fled to India, where 22 lived in various local communities. Seven people had remained in Jaffna, while 16 lived in Europe. One of her sons, Illango was imprisoned in Singapore during my stay following an unsuccessful attempt to go

⁸⁶ International Committee of the Red Cross

to Europe. The story of his attempted journey will be dealt with in the next chapter. Moreover, one of her relatives had been killed by SLA shelling and another by random shooting.

By observing Sonali's and Jeyadhani's kinship maps, the dispersion of their families emerges as a prevalent feature. In Sonali's case, some parts of the families such as her eldest brother and his children had no relatives abroad, while her youngest brother, his wife and all his children lived in the UK. Difference in migration patterns within a family may have several explanations: people abroad may primarily help their closest relatives to migrate, there may be a scarceness of money to finance a journey to the West, or people may simply have an unwillingness to move. Sonali's eldest brother was poor. He was living in India, two of his living children were back in Sri Lanka while the remaining three were in refugee camps in India. An interesting aspect with these trans-national bonds was that, in both Jeyadhani's and Sonali's cases, certain countries prevailed as destinations. Persons who however lived in countries that represented a diversion from where the rest of their family lived were without exceptions women. This reflects the practice that marriages are arranged to get the daughters abroad, and once they married, they eventually settled down with their husbands. Geographical dispersal may frequently be seen as more extensive among women than among men though they usually also stayed in touch with their natal family. Furthermore, remittances were usually sent back to the husband's family and more uncommonly to the wife's. While Jeyadhani's family received their remittances from the sons, the daughter actually owned their house. She had bought it to them a couple of years earlier, but had now stopped sending money to them as her husband had to help his relatives in Sri Lanka. As may be seen from these examples, and which has been maintained by Gardner (1995) in her study of Bangladeshi migrants from Sylhet, having a network of relatives in the West may determine people's possibilities to migrate. Proximity in kinship to people with capital is essential for obtaining loans big enough for being able to migrate. The increasingly strict immigration rules in the UK have now virtually blocked Bangladeshi families who do not have relatives in the West from migrating. Fuglerud (1999) and McDowell (1996) assert that relatives are important, but however not imperative for Sri Lankans' possibilities to move. In circumstances where Tamils in the West are not able to sponsor their relatives' journey they have to organise this by themselves. Failing to help relatives to move may have social familial implications, it may cause bitterness among the remaining family and shame among those living in the West (Fuglerud 1999).

However, due to the forced dispersal of which many were victims, people who came to India often settled with relatives who had not been part of their household in Sri Lanka. As all of Sonali's remaining children lived further abroad, she and her husband lived with the family of one of her brothers, his wife and daughter, and the wife and daughters of the brother who was shot by the SLA. The difference between Sonali and Jeyadhani on one side, and Rajkumar's family on the other, is striking in several manners. Though Rajkumar came from an area severely affected by the armed conflict, only two out of 93 relatives now lived in the West. One more had however returned from Europe to Sri Lanka by own choice. Four resided in the Middle East and only seven, counting him, Ambiga and their two children, lived in India. 54 people were still living in Sri Lanka. The structure of these three families reflects a general difference in complexity between people from Jaffna and elsewhere, a pattern I recognised among the majority of my Sri Lankan informants. This complexity was related to a general dispersal in India and further abroad, as well as intricate processes of marriages, economy and migration. It should also be stressed that kinship and kinship ties has been fundamental for people's and their household's subsistence and access to resources. These networks become increasingly important for the internal organisation of the Sri Lankans' households once they are established as the sources for their continuation and economic subsistence.

ECONOMY, MOMENT OF MIGRATION AND TRANS-NATIONAL BONDS

Families in Raja Nagar who received economic remittances could often be detected by the size of their houses. Raja Nagar is a semi-rural area with mainly one-storey buildings, but among these, there are several large palatial houses with tiled entrances and with flashy imported cars parked in the driveways which were owned and inhabited by Sri Lankans. Besides the Sri Lankans with relatives in the West, others partially resided in Europe and partially in India. These large houses can be very luxurious, and people may have expensive electronic goods, imported commodities and ornaments. Fancy television sets, stereos, air condition, and the latest household items may be seen together with fine carpets and expensive suits of furniture in leather. The level of wealth and the difference in living standards between this group of people and those without relatives abroad is highly evident when observing people's houses.

On the other hand, remittances from relatives in the West did not necessarily bring about great wealth and a high living standard, as we saw with Jeyadhani and Sonali for instance (see also Gardner 1995). The two examples below, that of Thirumal and Mala both have family relations that transcend national borders, but are nevertheless in radically different economic situations.

Thirumal is one of the better-off Sri Lankans in Raja Nagar. He was in his 30s and has lived in Europe for the last 14 years. In 1986, he was sponsored by relatives who lived in Europe. During the first years he lived in Northern Norway and worked in the fishing industry and supported himself and his family in northern Sri Lanka with his earnings. He managed to save up a lot of money and has now moved to the capital where he works and owns two shops. He visits Raja Nagar frequently where he has family. He can frequently be spotted driving around in a large Tata Sumo⁸⁷ together with friends with music played on high volume. He recently built a house in Raja Nagar for which he paid more than 10 million INR. He told me that problems with the local authorities, whether regarding immigration or issues related to his house building, were easily solved with money. He knew many immigration and police officers in Raja Nagar. Many of the local Sri Lankans despised what they saw as his lavish and exuberant spending and demeanour.

Mala was a Vellala from Chavakachcheri on the Jaffna peninsula. She, like many Sri Lankans who have fled to India, has undergone extreme hardships and her family have been severely affected by the war, to which she had lost six close relatives. She was internally displaced for many years before coming to India. She told me about shelling from the Sri Lankan Air Force and about harassment and random killing of civilians by the SLA and the IPKF. She said that the trouble started in 1980, but that the LTTE were able to protect the civilians most of the time. After her marriage in 1983 she and her husband had to flee from one place to the next for over three years to escape fighting and shelling. She told of numerous nights where she and her family had to hide in bunkers. One night, six people from the same family were killed when their house was shelled. In 1987, IPKF came to Sri Lanka and there was great relief among people. She was in Jaffna at the time, and they received food, drinks and salt from the soldiers. The LTTE were however sceptical to the IPKF and tried to prevent people from meeting them. When fighting between IPKF and LTTE emerged, she and her three small children had to flee again. Many people were killed by IPKF-random shooting, she said. From 1989 to 1998, Mala lived in eight different places all over the Northern Province to escape combat and violence. She often travelled by foot and journeys often took days longer than normal due to fighting.

Her husband managed to go to India by boat in 1991. He wanted to go abroad to earn money so they could manage the difficult situation economically. One of her sisters had an unsuccessful attempt in 1993 and was sent back to Sri Lanka. Mala's husband however finally managed to go to Europe in 1995 after having been sponsored by a relative. In 1998, she left for Colombo to try to go to India. She submitted her passport to the immigration authorities, and stayed in a 'lodge'⁸⁸ in the

⁸⁷ A large Range Rover-like Indian produced car.

⁸⁸ 'Lodges' are shelters in Colombo usually arranged by travel agents. These lodges are very expensive as the agent frequently also has to bribe the police not to close them down. People who are not able to pay the rents have

city for three months. She had no problems during her stay in the lodge, but other Tamils were arrested. She got her passport back with an Indian visa, and flew into Madras. She had no problems there either, but was heavily interrogated by the Q-branch. She said she was glad to be away from the war, but was worried that her husband was going to be thrown out from Europe. He was now living in his third European country, had no proper job and had a court case going. She said she was highly dependent on his remittances to survive. Though she did not like India particularly much, she said that the war had made life in Sri Lanka unbearable.

The difference between Thirumal and Mala are striking regarding their socio-economic situation. Thirumal migrated in the 1980s while European immigration rules were more relaxed and while the prices for such journeys were lower. Fuglerud (1999) also states that most Tamils who arrived in Norway in the early 1980s were recognised as refugees, while those who came after 1986 were not. Mala's husband on the other hand was struggling hard due to strict immigration rules and the travel expenses. Contrary to Thirumal, he struggled to obtain a residence permit and papers permitting him to get legal employment. As earlier stated, the time of migration is central regarding travel expenses as weighted against succeeding transfer of capital. Due to the tightening of immigration rules and bureaucratic difficulties, it has a significant say for people's opportunities to live in a Western country, to get work there, and eventually also for their possibilities to remit money to relatives in India and Sri Lanka. Kannan, an Indian academic and activist, stated that "*Strong refugee laws like Schengen and immigration laws, doesn't stop refugees, it only increases the rate for people*". He claimed that these laws did not stop people from entering Europe altogether; it only made it more difficult for the people who were severely affected, who had lost everything and who needed protection the most. For people with the necessary economic assets, the expenditures of such journeys posed minor problems. Van Hear (2000) has emphasised that by the 1990s, few people were able to seek asylum without the assistance of illegal agents. Kannan also said: "*Those who reach the first country (India) may not be the real first line victims*". He told me about a wealthy family who left Jaffna "*...without having seen blood*". They had access to good lawyers, and now were well established with three children in Germany. Comparatively, he told me about a boy who formerly had been a member of the LTTE: "*He fled to Germany, and was deported twice to Sri Lanka. He had to bribe them heavily to get out of Sri Lanka again*". He said "*Coming back from Europe is another death*". These aspects are challenging an approach on diasporas where boundaries are seen as fluid and where people are assumed to have greater

occasionally been arrested by the police in cooperation with the lodge owner. There have also been reports of abuse and extortion of people living in such lodges.

possibilities to move than before (e.g. Appadurai 1991, Clifford 1994). The Sri Lankans' possibilities to migrate were shaped by their economic assets and potentials, the existence of relatives or potential marriage partners in the West, and often also by these relatives' legal status in their country of residence. This could again be related to the moment of these relatives' initial migration. Earlier migrants were frequently able to sustain themselves more easily than the later. A comparable argument is presented by Gardner in her study, when she claims that people who do not already have relatives in the West largely are deprived of the possibility to migrate. The main reasons are the lack of economic assets which usually are linked to wealthy relatives in the West, as well as strict immigration rules. However, households do not remain static over time, they are in a continuous process of flux and change (Gardner 1995). The economic level of a household is highly dependent on people's status and situations in their various localities. The situation of a family may be dramatically altered if a relative in the West loses his possibility to support relatives in India or Sri Lanka. Likewise, Mala's economic situation is highly dependent on that of her husband, and her situation may be improved or aggravated depending on the result of his court case.

INCOME GROUPS AND MODES OF WEALTH ACQUISITION

With the increasing difficulties and expenses involved in migrating to the West, relatives who lived in Sri Lanka or in India could also be an economic burden for relatives further abroad. Many struggled to remit capital to their relatives, and as a consequence, many Sri Lankans in Raja Nagar with relatives overseas had to provide for themselves. On the other hand, local modes of wealth acquisition sometimes also served the purpose of economically relieving relatives overseas who struggled with a tight economy. The diverse modes of income and how the Sri Lankans without trans-national bonds made their living reveal the internal complexity of the Sri Lankan community and also reflect the difficulties that many Sri Lankans have had and still are experiencing in order to make their ends meet. It is, as articulation theorists also have argued, important to analyse the appropriation of surplus where it is produced (see e.g. Kearney 1986). By considering local production in India as well as in the West, together with the trans-national impact of foreign remittances, the distinctness of these economic systems are acknowledged but also their mutual influence and interlinked effects. On the whole, one can identify four modes of wealth accumulation among the Sri Lankans in Raja Nagar, of which several also could be found within one household.



Sri Lankan shop in Tamil Nadu

The first group are of course those with trans-national relations who received money and commodities from relatives who lived in Western Europe or Canada. They are the wealthiest, almost invariably people of Jaffna origin, and usually high-caste Vellalas or Karaiyars. Many of these people do not work in India as they subsist on remittances. These remittances were transmitted by means of the so-called informal *Hawala* system, which involved private transaction companies with offices in a variety of countries. A Sri Lankan who for instance lived in the UK would contact the company's office in London and

deliver the amount of money he wishes to remit to his relatives in India. He receives a transaction number which he presents to his relatives in India. The London office calls or sends a fax to the Madras branch and a courier delivers the sum of money to the relative in exchange for the transaction number. Garnet, said that since such transactions are illegal, the couriers wear a money belt under their clothes not to be recognised. He told me that the Western Union banking system transfer money in three minutes, but they charge 75 US Dollars which is too expensive for many Sri Lankans. The Hawala system overcome the strict exchange controls, and is frequently easier to access, much less expensive and just as reliable (see e.g. Ballard 2003).

The second category consisted of those who had established their own businesses, as Ambiga and Rajkumar for instance. The type of businesses varied greatly, and some businesses were more lucrative than others. Some of the most frequent ones were greengroceries or small stores, which often sold much favoured Sri Lankan goods and merchandises. Others had telecommunication centres, which could bring about a decent income due to the long distance calls from the Sri Lankans with relatives abroad. The likely profits from having telecommunication centres with international connexions is reflected by the entrance area into the Mandapam camp being crammed with such centres. It is also interesting to note that in one of the Sri Lankan ran local telecommunication centres in Raja Nagar they had installed

four big watches displaying the local times, not only in India, but also of 'Switzerland', 'London'⁸⁹ and 'Canada'. These three countries have the largest Tamil diaspora communities besides India. Others again established tailoring businesses, laundry services, garment shops or other similar affairs. Many Sri Lankans had struggled hard to start a business.

Ambiga and Rajkumar arrived in India in 1993 more or less broke and struggled immensely the first years. They worked very hard to build up their life again and experienced many setbacks along the way. They told me they often were hungry, and they struggled to find places to live because of their poverty. In the beginning the house owners did not think they would be able to their pay rent. Rajkumar had been a jeweller back in Sri Lanka and wanted to resume this business when they came to India. Ambiga said that Rajkumar went to the jeweller quarter in town to try to establish business connexions for trading and selling. She said that he initially was thrown out of the shops which he today is invited into. He was a new face and as they were poor he had little jewellery and people thought he had stolen it, she explained. It was very difficult in the beginning, she said, and Rajkumar often came home as a broken man. He was nevertheless persistent and returned again and again until people started to recognise him. Eventually, they also started doing business with him. Initially, the local jewellers complained about the quality of the gemstones he brought with him and he was often cheated. After some time, he was able to establish a network in the jeweller quarter and also start a business where he took orders from people in Raja Nagar and travelled regularly into central Akhadipuram. He earned money from the commission and also sold and bought gemstones and jewellery.

At the time of my fieldwork, Ambiga and Rajkumar had a decent economy. But both were working around 12-15 hours a day. Beside her domestic tasks, Ambiga's, was stitching and preparing hair oil which contributed to the family's economy.

As this example reveals, many Sri Lankans experienced tremendous hardships establishing an own business in order to get a sustaining economy. Others of course already had the economic means to do start their own enterprise and struggled much less.

The third category consisted of those who dealt with illegal businesses or things that were on the edge of what can be considered lawful, as Garnet and Ramaswamy for instance. Such affairs could be very lucrative, but frequently also very risky. This could involve smuggling of 'brown sugar' (heroin), gold, weapons or sandalwood⁹⁰. Other Sri Lankans worked as agents

⁸⁹ People usually referred to 'London' as if it was a country in itself, on equal terms as Switzerland, Germany or Canada, and almost never to the UK or Great Britain. An interesting comparison is that Gardner's (1995) Bangladeshi informants termed migrants living in the UK 'Londonis'.

⁹⁰ The slow-growing sandalwood tree is India's national tree and has a major religious significance. It is used in religious ceremonies such as in pujas, and in funeral pyres. It is also made use of in ornamental carvings and cabinetwork. The fragrant yellowish wood is exclusive and very expensive, and the trading and sale is government regulated. This has made illegal sandalwood trading a lucrative, but also a dangerous affair. There are reports on people caught for this crime to be badly mistreated by the police. India's "most wanted" and feared criminal for

for people who wanted to go to Europe or Canada illegally, where they had contact and dealt (either directly or indirectly) with human cargo traders, passport forgers and corrupt officials. Aspects of this agent business will be explored in the next chapter which deals with the migration process itself. Furthermore, some also worked as a mediators or middle-men for people who had problems in court cases or in muddled bureaucratic processes. Such cases involved 'knowing the right people' and often the circulation of 'dirty money'. Incomes from such affairs were largely from commissions and could at times be rather extensive. As we saw in the previous chapter, media often report on Sri Lankans' illegal activities. While some such affairs were important for Sri Lankans when planning a journey abroad, they also largely contributed to the negative attitude of the Sri Lankans that many Indians had.

The fourth category involved those who had local jobs. As Sri Lankans cannot be employed in government jobs in India, which also are the best-paid jobs, they exclusively work in the private sector. Some Sri Lankans are lucky to get a full-time job, while others take random jobs as painters, mechanics, drivers, auto-chauffeurs or other similar things. Many Sri Lankans, as Sivanesan for instance, were victims of indecent treatment by their superiors and sometimes also of lacking payment. His story was presented in the last chapter. The Sri Lankans' lack of civil rights in India was sometimes exploited by Indian employers, as many Sri Lankans were afraid or did not know how to respond to ill treatment. Hence, many Sri Lankans were skeptical to Indians as employers.

However, beside these four types of wealth acquisition, some Sri Lankans received a pension from the Sri Lankan state after having been employed by the government a number of years, even though they now lived in India. Certain people had no jobs or any regular income and struggled immensely to make their ends meet. Some subsisted with the help of friends, others got a little help from OfERR, while others again had to move into a refugee camp where they received food and a small but regular dole. The emergence of such situations may be caused by many factors. It might emerge suddenly, for example by serious illness making the person loose her or his job. It can also be the result of a situation where the only family member who lives in Europe who earns money and supports her or his family economically dies or is expelled from her or his country of residence. I know of circumstances where the latter

many years, the forest brigand Veerapan, who was wanted for many murders was first and foremost known as a reputed sandalwood smuggler. Veerapan was killed in 2004.

occurred, and where the entire family ended up in a refugee camp as they had no other income and no way of financing a journey to the West for any of the remaining family members.

These four modes of income are of course overlapping. People in the same family frequently engaged in different economic fields, and sometimes one person contributed to her or his family's economy in several of these fields at the same time. As earlier presented, Jeyadhani's family received money and commodities from her sons who lived in Europe, while her husband had a part-time job as a driver. It is also important to bear in mind that remittances also could be of relief for Sri Lankans in the West. Suthalingam from Valvettithurai, had four children in the West who sent him and his wife money. With this capital, he was able to open his own private business, and the economic pressure on his children to support him was alleviated.

REMITTANCES AND LOCAL IMPLICATIONS IN RAJA NAGAR

Having established the Sri Lankans' modes of income, I will now turn to the effects of this trans-national economy on local life in Raja Nagar. This refers in particular to the economy of the wealthier Sri Lankans who received large sums of remittances from relatives abroad, and people like Thirumal who travelled regularly back and forth between India and a Western country. The impact of the trans-national economy should however not only be considered in pure financial terms, that is, how the money is spent or possibly invested. It is important to recall the mistrust and the emergence of fear following the assassination of Rajiv Gandhi. As stated above, the large amount of money many Sri Lankans were in possession of was highly visible to outsiders, for instance by their large houses. For a poor host population, large wealth and excessive expenditure by certain Sri Lankans could seem provocative to many Indians. I also maintain the importance of focusing on the effects of this economy, not only on the relationship to the local Indian population, but also to the other Sri Lankans who did not have such bonds.

Spending and investments

Earlier, I pointed out some limitations to the modernist approach on migration. However, such an approach force us take a closer look at the local consequences of trans-national remittances. Certain wealthier Sri Lankans owned large hotels and stores in central

Akhadipuram, but few of these were forced migrants or refugees, and most came and established these businesses before 1983 when the exodus to India commenced. The majority of the Sri Lankans in Raja Nagar came as a result of the armed conflict, and the people with trans-national networks seldom invested their money in local long-term enterprises and projects. Remittances were, as stated afore, used to sustain households or they were spent on large houses, big cars, gold, jewellery and electronic goods. Those who started own small businesses such as Ambiga and Rajkumar did it of necessity, for their own sustenance. Such businesses rarely brought about large incomes, usually only enough to support their own families.

The Sri Lankans' migration-based economy did not constitute a significant contribution to the local economy, maybe with the exception of employing local workers for constructing houses. When I returned to Raja Nagar one and a half year after my fieldwork, certain areas were unrecognisable due to the extensive construction of houses in the area. These large houses may instantly give the impression that people are attached and wish to remain in Raja Nagar, but I believe they may just as well indicate the opposite, namely temporality. For the majority of the Sri Lankans, India was considered a momentary place of residence, and people awaited a situation where they could return to Sri Lanka or a chance to migrate further to the West. Among others, such as Thirumal, India was an additional place of residence besides his country of residence in Europe. These Sri Lankans usually spent money lavishly instead of investing money in local enterprises because they had no intentions to remain in India. This, I believe can be related to Van Hear's (2000) and Kårtveit's (2003) argument regarding migration and remittances in Sri Lanka and Palestine respectively. They argue that remittances are deployed on subsistence needs and other 'non-productive' uses and private consumption to reduce risk in an insecure and treacherous environment. In both cases, the markets for import of goods are insecure. In the case of Palestine, this is due to the Israeli military occupation, while the economic embargo on LTTE-held areas and the military siege of Jaffna, Batticaloa and other larger Tamil cities by the government forces leaves the market for such businesses, at best, arduous in Sri Lanka. Restrictions on import of goods, high unemployment, problems with corruption and the risk for military attacks are also important constraints. Nick Van Hear argues that people in Sri Lanka are not willing to risk investing in a society under strain where the possibility of losing everything again still was imminent. They would wait until the situation would be politically stable enough, and until

reconstruction is under way. The aspect of temporality follows a similar line of reasoning, no-one wanted to invest in a place they later planned to leave. This exposes a significant shortcoming in the modernist perspective, which primarily is concerned with remittances as leading to local economic development at the place of origin. It fails to take into account the hindrances for development such as war, occupation and the conceived temporality of Sri Lankan habitation in India. Comparatively, in Gardner's (1995) case from Bangladesh, the social and political conditions were rather stable. Migration and remittances were the prime means for people to improve their local economic positions, for local development and in transforming local village organisation. Households which sold and lost land tended to be those without relatives in the West. The situation of the migrant communities in Sylhet in Bangladesh thus diverges from that of Sri Lanka, Palestine or that of the Sri Lankans in India. Their situation is not one of political uncertainty and instability, nor one characterised by a sense of temporality. Modernists also focus on migrants as individual rational decision makers, an argument which do not account for structural formations in a society which could obstruct people's willingness to investments in that society. Sri Lankans in India often had problems in the Indian bureaucracy and were often victims of extortion. Many Sri Lankans emphasised that corrupt police officers and the Q-branch knew which people had relatives in the West, and often purposely visited them to ask for bribes. Jaffna Tamils were not only more vulnerable to extortion than other Sri Lankans due to their greater likelihood of having links to the LTTE, but having relatives in the West and thus being potentially wealthier was an equally strong incentive.

Local economies and interrelated domains

It should again be maintained that one cannot approach the Sri Lankan diaspora without regarding various forms of production at different locations, that is, in India, in the West as well as in Sri Lanka. There is a flow of information, commodities and influence between people in the different locations which not only goes from the West to India and Sri Lanka. People are mutually dependent in several ways, for instance in relation to family expectations and obligations. As we will see in the next chapter, trans-national marriages between a person living in the West and the other in India or Sri Lanka were frequently performed in India and arranged by the groom's relatives. The advantage of articulation theory is precisely that it emphasises the existence of different economic fields instead of a single world capitalist system, as advanced by dependency theorists (Kearney 1986). It also stress that these

economic fields are reproduced according to their own imperatives and that it does not omit cultural formations, the latter having been pronounced as a weakness of the world system theory (see e.g. Hannerz 1989). The social and cultural conditions under which many Sri Lankans in the West live in is relevant for the amount of surplus they are able to remit. As we saw from Mala's husband's situation, he had problems with the immigration authorities and had a court case going in his country of residence. His situation also had consequences for Mala and her children in India. Likewise, the living conditions of Sri Lankans in India are also of importance. The general skepticism which was prevalent between Indians and Sri Lankans in Raja Nagar and the corruption that many were victims of, may not only have been a factor preventing people to set up a business though they had the economic means. False LTTE cases or minor offences could be used by corrupt police officers to extort money. On one occasion, a Sri Lankan in Raja Nagar betrayed his more than 20 years long friends by reporting a false LTTE case to corrupt policemen eventually cost them 300,000 INR. He did this after having encountered problems with the police due to his agent business. He received 100,000 INR himself and avoided more trouble with the police⁹¹. Such incidents could eventually also be severe for relatives who lived in the West as they often were the only ones with the economic means to pay the relatives' way out of such situations. As for my friends, they were from Colombo and did not have relatives abroad. They had to find other economic means to solve this problem.

Remittances and local sentiments

The relationship between the Indians and Sri Lankans in Raja Nagar is, as we have seen, rather strained. According to my Sri Lankan informants this relationship was further deteriorated by their often visible wealth. Many Sri Lankans believed Indians were jealous of them. Though Ambiga and Rajkumar were not among the more affluent Sri Lankans in Raja Nagar, they shared this feeling. They told me that they had come to India with almost nothing and struggled immensely the initial years. Due to hard work they were now better-off than most of their Indian neighbours who had done nothing to help them while they were poor. Ambiga said that Indians generally were lazier by nature, while Sri Lankans were more industrious and hard working. As we saw in the last chapter, such a view was part of the common preconceptions on Indians. Indians were thus often deemed responsible for their

⁹¹ This story will be presented more extensively in chapter eight.

own poverty. The high level of wealth among the Sri Lankans was indeed a source of complaint among the Indian host population. As earlier stated, Indians commonly argued that the general prices in the state had risen due to the arrival of the rich Sri Lankans. They spent money lavishly and paid excessive house rents when they first arrived in India, they said. This conception was also common among many Sri Lankans. A number of Indians also expressed anger that the Sri Lankans were cared for by the Indian government while they continued to live in poverty (see also Bastiampillai 1996). In other words, the perceived difference in wealth between Sri Lankans and Indians was a major reason for the grievances between these populations.

Wealth, jealousy and the evil eye

The jealousy that many Sri Lankans felt also had another dimension. Many were cautious of the evil eye which is inflicted unintentionally by jealousy. The use of the evil eye against both people and houses is eminent in Tamil society, and barely any houses or shops in Raja Nagar are left unprotected by a demon face (which is intended to attract the attention of the inflictor or the curse itself) or by other talismans such as sacred ash and turmeric, mirrors, neem leaves⁹², or chilies and lime tied together in strings over the house and shop entrances. Like unfinished houses, which frequently are protected by a scare-crow with a demon head, children are 'unfinished' adults and are especially vulnerable to the evil eye. They can easily be moulded due to their 'incompleteness' (Daniel 1984). A customary protection for small children is to smear a big black *pottu*⁹³ on their forehead, which according to Daniel (1984) act as a magnet against the malediction. It also prevents people from saying that the child is pretty and thereby avoid the ill-effects of the evil eye (Hoole 1997). Ambiga told me that her son, who was six, always became ill and got fevers after festivals and celebrations. She said that he always dressed up in his finest clothes on such occasions, which she believed triggered the feeling of jealousy among people in their street. When I asked people about their use of talismans, they usually said that they did not know whether they believed in such things as the evil eye, but used them just in case. Most people narrated that they knew of incidents, or had experienced situations where some sort of black magic was afflicted 'successfully'. The practice of protecting one's house, shop or children from negative forces was prevalent

⁹² The fruit and seeds of the neem tree are known to yield a medicinal aromatic oil. Many described neem as a 'natural antibiotic'.

⁹³ The coloured spot used by Hindus on their forehead (signifying the third eye of Siva).

among most people, Indians and Sri Lankans alike, and whether they claimed to believe in such things or not.

INFLUENCE AND CONCEPTIONS FROM ABROAD

When looking at trans-national influence, it is necessary to look beyond the mere economic dimension and incorporate issues related to values and ideas. It has been argued that today's increasingly cosmopolitan and trans-national world should make us reconsider traditional notions of cultural production which occur at well-bounded small-scale societies. Not only identities and ethnicities are undergoing transformations, but also traditions and cultures (Appadurai and Breckenridge 1988). The cultural production and emergence of the LTTE cosmology (see e.g. Schalk 1992, 1997) involves the emergence of new cultural formations, as the diminishing importance of caste and dowry, and the production of a collective memory founded in a discursive process where history is selectively redefined. Alternative historical interpretations are disqualified and largely regarded as heresies within this discourse. These processes have influenced local cultural practices not only in Sri Lanka but also in the diaspora communities in the West, opening up for what Fuglerud (1997, 1999) labels revolutionary ideologies at the expense of traditional values. These cultural formations have been distributed and reproduced by the LTTE by means of media and technology, but also through rituals and ceremonial commemorations of 'martyrs'⁹⁴. The organisation has in other words sought a refashioning of *Tamilness*, of what it means to be a Tamil and to naturalise a form of Tamil identity which incorporate their understanding of history and collective memory (Cheran 2001). The economic aspects of the trans-national bonds described above primarily go from the 'centre' to the 'periphery' in the form of remittances. Cultural production and transformation however also go from the 'periphery' to the 'centre' and cannot be fully understood by only considering the cultural production which takes place where people live. It takes place across geographical boundaries and should incorporate

⁹⁴ LTTE's concept of Martyr or *Tiyakam* deviates from the Judeo-Christian notion, though they frequently appeal to the Western notion of martyrdom in their English translations of their texts (Schalk 1997). The concept of *Tiyakam* originates from the Bhagavad-Gita and is represented by the "voluntary abandonment of life" in order to reach an aim which is declared holy. This abandonment is a reaction to the loss of life of a comrade (Schalk 1992). A *Tiyaki* is in fact one who gets killed in the act of killing. According to Peter Schalk, this concept stands in the tradition of the concepts emphasised by Netaji Subash Chandra Bose during the Indian independence movement. Bose was highly critical to Mahatma Gandhi's policy of *ahimsa* denoting non-violence as a political means for obtaining independence. Bose's movement revived the notion of *Tiyakam*, which was further taken over by Prabhakaran and the LTTE. It should however be emphasised that though *Tiyakam* derives from the Bhagavad-Gita, and though many other of the organisation's central concepts also stem from Hinduism: for example *arpanippu* – 'dedication of man to God', *bhakti* – 'devotion, dedication and ascetism', and *balidan* – 'gift of life as sacrifice' (Schalk 1997), the LTTE is a non-religious organisation and no notion of after-life exist in its cosmology for fallen comrades or *Tiyakis*.

notions such as interaction with visitors, media and the power of imagination (Appadurai 1991).

'Westernisation' and respectability

The cultural production described above was more difficult in an Indian locality due to the ban on the LTTE after Rajiv Gandhi's death. Indian Tamil nationalists have however on several occasions commemorated fallen LTTE-fighters on the Tiger's "*Maareevan day*"⁹⁵ on November 27th by arranging meetings in support of the banned organisation. Also, on Prabhakaran's birthday, posters featuring the LTTE-supremo have frequently appeared in prominent places in Madras (The Hindu 2000.11.26). However, such tributes never involved Sri Lankans as the risk for sanctions would be too great. The dimension of trans-national cultural production in Raja Nagar followed different parameters and usually involved encounters between 'Western' and 'traditional' Tamil values, though many also emphasised and cherished LTTE's work to eliminate caste differences and dowry. Such global connexions were offered to people through media, by relatives and visitors from overseas, by these people's exercising of values and their distribution of western consumer goods.

People could distinguish Sri Lankans visiting from the West from those who resided in India, in similar ways as they could differentiate a Sri Lankan from an Indian, as described in the former chapter. People were betrayed by their dressing and by their comportment, which can be related to Feldman's (1991) notion of 'telling', where the body is interpreted as an ideological text and where corporal symbolism is organised around paradigms of purity and impurity. Thirumal and others living further abroad usually dressed in 'western' clothes, like jeans, caps, t-shirts etcetera and exercised a behaviour that often challenged more traditional modes of conduct. Such comportment was not always valued in Raja Nagar. Thirumal was disregarded by many local people, not only because of his excessive use of money. People also claimed he was a womaniser, that he befriended corrupt Indian officials and that he liked to drink. All these qualities refer to values and behaviour which contradicts what was considered respectable and decent moral comportment. Thirumal was also highly noticeable when he drove around in the neighbourhood with his friends with loud music on his car

⁹⁵ 'Heroes' day' or 'Martyrs' day' inaugurated for the commemoration of fallen cadres.

stereo. This sort of behaviour was rather unusual in Raja Nagar and naturally attracted people's attention.

As we saw in the last chapter, restrictions and codes of conduct were more severe for women than for men. Women dressing and behaving in 'western and untraditional ways', was often disapproved by local people. This can be compared to Arachelvi and the other more 'modern' Sri Lankan girls in Raja Naga. Fuglerud (1999) has maintained that women living in the West are, in a marriage context, frequently looked upon with suspiciousness by men if they have not been watched over by their parents. Women may be considered corrupted by western culture, which relates more to Tamil notions of femininity than by sexual purity *per se* (the latter usually being taken for granted). Women are expected to follow certain codes of conduct, which reflects moral purity and virtuousness. This is represented by a body language displaying shyness, timidity, passiveness and obedience (Fuglerud 1999). With reference to chapter four, Sheryl B. Daniel (1980) presents three conflicting positions on the relationship between men and women in Tamil society. The first emphasise male supremacy and female submission, and by virtue of being married, the woman obtains status and respect⁹⁶. This was the dominant perception among people in Raja Nagar and is also the one referred to by Fuglerud. *Sakti*, the female power is considered more powerful than that of men and should be controlled during all stages of life (Daniel 1984, Daniel 1980). Before marriage this should be done by her father and brothers and after marriage by her husband and sons (Daniel 1980). Hence, the status of women is transformed by marriage, and by this ritual consumption, she obtains a respectability unobtainable for an unmarried girl. A married status also eliminates potential rumours of promiscuity and of being a woman of 'bad character'. In other words, when Arachelvi and women visiting from the West were disregarded or seen to have lost their female valour and virtue because of their way of dressing and also if they associated with men outside the close family, this must be seen in relation to their status as unmarried women. Though people's attitudes on correct female conductance and on the behaviour of unmarried women stood strong in Raja Nagar, it usually also varied in degree to a person's urban and rural origin and often also between generations. Thirumal, who was disregarded by many people due to his behaviour, was also clear on how women should behave. He told me that a Tamil wife was preferable to a

⁹⁶ The second emphasised equality between husband and wife, while the third stresses that the husband should listen to his wife in order to improve in life.

Norwegian, as they would cause no trouble and would be faithful. This is consistent with Feldman (1991) argument, as the trans-national impact on the purity of women would be interpreted and negotiated through a sensory identification of bodily signs and expressions but also by attributing certain qualities to western societies. Such signs are phenomenologically construed and valued against given cultural notions of morality and valour. Tamil girls living in the West were, like former female LTTE fighters, often feared by Tamil men as they were seen to be difficult to manage and control. But Tamil women living in the West also embody a dimension of ambiguity, as they also could represent an entry to the West for a potential groom, and are thus in a sense also favoured.

Imagining the West

There is also another important dimension of the trans-national connexion between Sri Lankans in India and the West. People visiting from further abroad also activated the imagination of people in Raja Nagar. Appadurai (1991) contends that technology and trans-national connexions trigger people's imagination in a world which is increasingly globalised. A wider range of possibilities and potential lives have been made evident by people in Raja Nagar through media, visitors from the West and the display of 'western' commodities and consumer goods. This is an important notion which also have been emphasised by Gardner (1995) among Bangladeshi migrants and their kin. Visitors to Raja Nagar dressed in 'modern Western' clothes, and brought with them goods and commodities largely unavailable in India. Many Sri Lankans commonly complained about the quality of Indian goods and believed that things produced in the West were better. Facets such as dressing, comportment and the displaying of Western goods, but also Western movies and music videos frequently produced ideas about life in the West as being synonymous to success, affluence and getting rich. The dream about the West was, as we saw from Murugan in the former chapter, very strong and also widespread in Raja Nagar. During my fieldwork, I was asked a number of times by Sri Lankans if I could sponsor them to Europe. However, it is also important to note that the affluency which many observed or attributed to visiting Sri Lankans were from encounters with wealthier people who could afford travelling to India. People who struggled economically, such as Mala's husband for example, could rarely afford a journey to India or Sri Lanka. Consequently, the difficulties which many endured could remain largely unknown to people in Raja Nagar. As people's conceptions of the West often were shaped by the wealthier Sri Lankans who visited Raja Nagar, their ideas could consequently be rather one-

sided. This does of course not neglect that many were highly aware of their relatives' problems and difficulties in the West, and that people had been informed from friends about the problems many underwent. But at the same time, many Sri Lankans could also feel shameful about such difficulties, and often wanted to withhold such information from their kin. It should in this context also be emphasised that it was not only the West but also their homeland which was invented and imagined by Sri Lankans in Raja Nagar. Sri Lanka or Tamil Eelam was frequently conceived as 'the promised land', even among people who had not lived there for many years or since they were small. India thus in many ways fell in between Sri Lanka as the promised land, and the West as the key to a successful and prosperous life.

ENDING REMARK

In this chapter, I have focused on the importance of the trans-national bonds and remittances for the Sri Lankans' in India and, in the light of the former chapters, looked at its importance for the Indo-Lankan relations in Raja Nagar. By applying various migration theories, I have explored the production and distribution of goods, as well as influence and the negotiation of values at and between different geographical domains. Displacement and the trans-national quality of Sri Lankans' settlement have had structural effects on the Sri Lankans' lives in Raja Nagar. New household structures have emerged and the level and modes of income have been transformed. These trans-national processes and formations have affected people's categorisations of each other and their identity conceptions, both within the Sri Lankan community as well as in relation to the Indian host population.

The trans-national bonds prevail among Jaffna Tamils which largely distinguish them from the remaining Sri Lankans in India regarding affluency and living standards. This does however not ignore the fact that there are considerable differences between different Sri Lankan families with relatives overseas. Migrated kin are expected to help relatives living in Sri Lanka and India with remittances, and do thus influence their economic security and chances to migrate from India. However, in situations where Tamils overseas struggle economically, local modes of earning by relatives in Raja Nagar could also relieve relatives in the West by reducing the need for remittances. It is therefore significant, first to acknowledge local variation between Sri Lankans in Raja Nagar with regard to the quality of their possible

trans-national bonds, and secondly to consider economic production at various localities and to incorporate the interseccionality of these trans-national domains.

When considering the relationship to the host population, trans-national remittances must be considered both economically and in a relational dimension. First, settlement in India must be seen in relation to the temporal nature of their stay in India. Remittances were seldom used for other means than sheer subsistence and for material consumption, and to a very limited degree led to any local development. But the differences in economy between the Sri Lankans and the Indian host population had negative effects on their relationship. Jealousy was common, and in addition, charges of having caused the rising prices in the state led to a strong feeling of estrangement among many Sri Lankans. The trans-national economy and their often ensuing wealth lead to a further reclusiveness and a strengthening of the mutual social dissociation between the two populations. There is also a discursive dimension to the trans-national economy. The disciplining fear emanating from the transformation of the Sri Lankans after the assassination of Rajiv Gandhi appeared to have been strengthened by this economy. Dynamics of surveillance and corruption were not only directed against people who were liable to have LTTE-links, but just as much against people who had relatives abroad. Their affluence made them attractive targets for extortion. Moreover, practices by wealthy Sri Lankans such as *Thirumal*, which involved befriending and bribing bureaucrats and officials in order to get building permissions or other authorisations, helped establishing and reproducing a culture of corruption affecting the Sri Lankans. Regarding the patterns of settlement, it seems apparent that the already existing differences between people who lived inside and outside refugee camps, and between those with relatives abroad and those without were not only reproduced in India, but also increased. The accessibility to resources among people outside camps weighted against those inside, and the trans-national bonds were major factors contributing to such a development.

Another important dimension of the trans-national bonds is the negotiations of ideas and values between different domains, in India, Sri Lanka and the West. As we saw above, traditional values and notions of respectability on one side and conceptions about the West with its imagined wealth on the other often appeared contradictory. However, as argued in the former chapter, apparent inconsistencies were recurrent among people, but should be addressed by considering Katherine Ewing (1990) and Alfred Schutz's (1970) arguments,

when they contend that people conceive themselves as the originators of their current actions and thus as undivided timeless wholes. Their environment and their fellow-men are crucial in people's self-definitions and in their identity constructions, but these people extend beyond Raja Nagar to include people who live overseas. Trans-national formations relating to negotiations of values, as well as to material and economic transfers have a crucial influence on people's lives and for how they perceive themselves and are perceived by others in their local communities.

Chapter 7 – “A passage from India”

INTRODUCTION

As argued in the last chapter, trans-national influence and familial aspects are highly interrelated. There, I focused on the economic aspects of migration, as well as the production, transfer and influence of ideas and values between different geographical domains. In this chapter I will concentrate on the more tangible aspects of migration. This will have a dual focus which incorporates social and familial features, as well as the practical and structural aspects which relates to organising and carrying out a journey. As we have seen, family bonds are important, not only because of expectations and obligations that transcend national boundaries, but they also play a significant role in organising passages abroad. People's abilities to migrate are often determined by relatives who may serve as economic supporters or as agents. Moreover, as marriages with someone living in the West represents an opportunity and a way for many to migrate, relatives abroad may play a significant role in finding a spouse for a marriageable kin in India. Certain features are fairly distinctive regarding the Sri Lankans' organisation of journeys to the West. This relates to economic and bureaucratic practicalities and problems. The demonisation of the Sri Lankans after the assassination of Rajiv Gandhi in 1991 and the increasing corruption that the Sri Lankans have become victims of is central here. But as will be evident, such practicalities also involve methods that seek to overcome immigration barriers to the West.

Two empirical cases will be central in this chapter. One is the marriage and planned journey of Devani, Ramaswamy's daughter, and the other one is Illango's failed attempt to migrate to the West. Their stories shed light on the organisational aspects of marriages and the arrangements of journey's abroad, the anxiety and problems experienced by the remaining relatives, and the comprehensive costs involved in organising a journey which again may have a substantial impact on the economic situation of a household.

REPRESENTATIONS OF THE WEST

Appadurai's (1991) argument about a wider set of possible lives being imagined in an increasingly globalised world is a central notion also in this chapter. Most of my informants expressed a strong wish to either go to Europe or Canada or to return to Sri Lanka if the political situation allowed them to. It was common among Sri Lankans, especially those living in Raja Nagar to express a strong disapproval of India. Stories of Sri Lankans struggling economically, striving to get jobs and having a hard time repaying debts to agents or relatives for their journey to Europe in their respective western countries were known in Raja Nagar. Nonetheless, Europe and Canada were by many imagined as places with almost unimaginable possibilities for success and wealth-acquisition. On one of Murugan's visits to my house told me about his aspirations for going to Europe. He had an unmarried brother in London who was planning to get married in about two years. In about three years, Murugan told me he would go to London "*to get rich*". He said he wanted to get a nice car and a cell-phone, gesticulating and playacting being a 'laid-back cool guy' driving nonchalantly a car with his elbow out of the side-window and talking in a cell-phone. The West represented access to attractive goods or commodities, and Murugan was not unique in that sense. A large number of Sri Lankan acquaintances in my neighbourhood in Raja Nagar asked me if I could sponsor them to Norway, or if I could help them get a visa. But there were others with different views. Garnet had lived many years in Holland, but had returned to India where he also lived before going to Europe, he was afraid to go back to Sri Lanka. He disapproved of Holland and was never at ease there. He did not like telling people that he used to live there as people would believe that he had "*committed a big crime*" since he had returned to India. He stressed that many Sri Lankans generally had an unreal image of the West, and that many were unaware of the uneasiness one could feel by living in a country which is culturally alien. Many imagined the West to be a place where everybody were rich and earned lots of money. But the fact, he said, was that many foreigners were struggling culturally and economically and were subjects to racism. Thirumal, who had lived in Norway since 1986, also expressed a disapproval of the West. He spoke of cultural conflicts, racism and a female emancipation that had gone too far for his taste.

As we saw in the last chapter, the excessive wealth of certain Sri Lankans, represent by large houses, cars and jewellery undoubtedly helped portraying the West in such a way. But the

increasingly strict immigration rules in Europe had at the time of my fieldwork made such aspirations difficult, very expensive, and as we shall see, also dangerous.

CROSS-NATIONAL MARRIAGES

For many, going to Europe was seen as an opportunity to obtain a decent life and to get away from India, a country many disliked. For this reason, Tamils living in Europe were highly sought for as spouses. During my fieldwork, I participated in several weddings between Sri Lankans living in Europe or Canada and Tamils living in India. While the men frequently lived in the West, the women were the ones who lived in India. Devani, Ramaswamy's daughter is an example of one such union, which case I will present below. While men living in the West were highly sought for as spouses. Women on the other hand, were, as argued in the last chapter, more ambiguous in that respect. This can also be said about marrying former female LTTE-cadres. Former Tigers were feared and seen as 'hard to control', while women who had lived a long time in the West without the control of their parents were frequently believed to have lost some of their female virtues and having become too 'emancipated', 'westernised' and 'morally corrupted'. Marriages were also arranged by relatives in India between men who lived in Europe and women in Sri Lanka. Due to the strict immigration rules in Europe, such marriages could not be carried out in his country of residence – the girl would not be admitted before being married, and due to the war and the man's status as asylum seeker in his country of residence, the marriage could not be performed in Sri Lanka. On some occasions, when refugee families lived in camps, OfERR could help organising such weddings.

Aspirations for the 'West' and exploitation of Sri Lankan women in India

The aspirations for trans-national marriages and a better life outside India were sometimes exploited by married Tamil men living in the West. Some of these men showed up at refugee camps in India on the pretence of finding a spouse. After having found a girl whom they liked, they promise to marry her, and often lure the girls into having sexual relations with them. After a while however, they go back to their home country, promising to come back soon, but never return. The girls' prospects for remarrying are at best small due to the social stigma and humiliation involved in being unmarried and having lost one's maidenhood. For those who have become pregnant or who become single mothers, the shame is even

greater⁹⁷. Chastity is a principle which stands strong in Tamil society both as a representation of respectability and morality, but also in a cosmological sense. Chastity is commonly seen as the source of a woman's power, which can generate almost godlike abilities. Such a comprehension can be found both in India (Price 1996) and in Sri Lanka, but also in the societal order as it is defined by the LTTE⁹⁸ (see e.g. De Mel 2001, Schalk 1992, 1997). As such exploitation is an increasing problem in the camps, OfERR are working to educate the camp refugees and organise programmes trying to prevent this from taking place. This phenomenon is however not exclusive for camp refugee. Devani's cousin who lived in Akhadipuram wedded a man who lived in Germany, whom she was supposed to join a few months later. But it was uncovered that he already was married and that he also had a child in Germany. She got a separation and remarried a Sri Lankan in Colombo some months later. For girls of urban origin, such as Devani's cousin who was from Colombo and who had lived most of her life in Akhadipuram, this was possible. But for girls of rural origin, where traditional values stood stronger, such incidents could be fateful. Remarriage would never be a possibility.

Many who are aware of this increasing problem still choose to marry off their daughters to men living in the West. For those who have local contacts, it is usual to secretly investigate if their daughter's future husband already has a relationship or is married. This is of course not always possible, and some families nevertheless take the chance of marrying off their daughters in spite of such doubts. Sometimes they end up being deceived.

Organising a marriage

A son is usually considered marriageable in his mid- or late twenties, and a daughter in her late teens or early twenties. It is at about this age that parents begin planning a wedding for a son or a daughter, and start collecting personal information about potential spouses. At the age of 35, the prospects for establishing a family decrease quickly. In certain rural areas of Sri Lanka and India, marriages are planned early, and knowing one's future spouse from a very young age is not uncommon. Marriage represents a watershed in a person's life. According to

⁹⁷ In the Laws of Manu, it is stated: "The Vedic verses for the wedding ceremony of joining hands are established only for virgins, and nowhere among men for those who are not virgins, for such women are deprived of the religious rites" (Manu 1991:8 verse 226).

⁹⁸ In its martial feminism, chastity is seen as a source of strength, and Schalk (1992) describes the image of the LTTE woman fighter as an 'armed virgin'.

Fuglerud (1999), it is only through marriage that you become a full member of society. The ideal of the 'householder' has a central position in Tamil society, and behaviour and status differs radically depending on whether you are married and not. Marriage places the person in a hierarchically and context-specific relationship towards his surroundings. In relation to the outside, it is expected that the wife and unmarried members of the household should keep to the back when the husband speaks. Among unmarried, anyone are free to speak, superiority or leadership is not defined. There is a deliberate under-communication of hierarchical differences. Marriage are therefore one of the most important events in a person's life, as it involves a transformation of a person's status. Daniel (1980) and also Hoole (1997) argues that especially the status of women changes after marriages, and that it is through marriage that a woman obtains respect. Hoole states that "With marriage, the cat could come out of the bag, if there was a cat to come out. Even a tigress was all right! But certainly not before marriage ... Without marriage, she was there simply to be bullied by her brothers and father and mother, everyone telling her what she ought to do or not" (Hoole 1997:221-222).

Though arranged marriages today are the most accepted kind of nuptial union, Hoole (1997) claims that this has not always been the case. He argues that the ideal marriage in the past involved romantic love. In the *Thesawalamai*⁹⁹, the customary law of Jaffna, women attained majority and could marry without her parents' consent from the age of 13 (Tambiah 2001). Though love marriages have become more frequent in India and Sri Lanka, especially among the urban population, arranged marriages are still decisively predominant among Tamils. Love marriage is still regarded as a deviation from tradition. Among the Sri Lankans who lived in Raja Nagar, few married out of love. But among camp refugees, love-marriages and divorces were more common. According to people in OfERR, the high number of love marriages was first, due to the dense living conditions in the camps where people experienced less privacy. Secondly, many younger people were often in the camps without their parents, who under normal circumstances would act as a sanctioning party towards their children's behaviour. The greatest difference between these two types of unions (love- and arranged marriage) is not primarily the consent of the parents, but the agreement between the families concerning marriage benefits and dowry (Fuglerud 1999). For this reason, marriage should be given considerable attention in the context of migration, as dowry is integral in both aspects.

⁹⁹ The *Thesawalamai* was a customary law prevailing among the Tamils in Northern Sri Lanka for several centuries. It was later codified by the Dutch (Tambiah 2001).

The ideal marriages for Tamils (in a Dravidian kinship system) are between bilateral cross-cousins¹⁰⁰. According to Hoole (1997) through such marriages caste could be preserved, property kept within family, and dowries could be easily negotiated. When spouses are sought for outside the family, it may be due to the lack of marriageable cross-cousins, but frequently it is due to other priorities (Fuglerud 1999). Securing the future for a daughter, son and oneself through migration can be seen as one such priority. Devani's marriage, which I am now to present, illustrates some of the features and procedures involved, from when the decision of getting a daughter married is taken, through the marriage itself, to the process of migrating.

FINDING A SPOUSE

When Devani was 23, Ramaswamy, started inquiring for a suitable husband for his daughter. It was important for him that his daughter should marry a Sri Lankan, preferably one who lived in the West. It is usually of great importance that the son or daughter should marry someone from the same religion and within the caste¹⁰¹. Differently from most Vellalas, where caste is imperative when arranging a marriage, Ramaswamy was not very concerned about caste. He was a *Thevar* – a so-called 'Backward Caste'. Ramaswamy did his inquiries via friends, relatives and in newspapers – where there are own sections with marriage proposals. Information about religion, caste, education, family background, personal characteristics, economy, legal status in country of residence and whether the person have been married before are of relevance when evaluating marriage candidates. Ramaswamy found several potential candidates. He started with the most preferred, contacted them and sent personal information and a photograph of Devani. When a family responded favourably, horoscopes were compared to look for potential mismatches or incompatibilities. Ramaswamy, who himself had malefic aspects in his horoscope was anxious that Devani should get married with a well-matched husband.

However, Devani told me a few days after her wedding that she had had own requests concerning her marriage. She carefully tried to express those to her father, but without success. She told me that she met a Sri Lankan about six years ago whom she fell in love with. Her feelings were reciprocated, and they both wanted to get married. She told me that she knew his parents well and they were very fond of her. When Ramaswamy started to plan her wedding, she asked for his permission to marry the man. He consulted their horoscopes, but found them to be incompatible and therefore refused. When she told me this, she suddenly said: "*excuse me*" and picked up a handkerchief and wiped her tears. She was crying. She recovered and apologised. She told me that the man she had loved promised never to marry anybody else than her. I asked her if she thought that her father would have accepted

¹⁰⁰ For a man, this is the daughter of his mother's brother (MBD) or of his father's sister (FZD); for the woman, this is the son of her father's sister (FZS) or her mother's brother's son (MBS). Marriage between parallel-cousins (e.g. FBD/MZD or MZS/FBS) is on the other hand regarded incestuous.

¹⁰¹ Christians are also included in the caste system, and Christian Vellalas have for instance been a rather well-educated and powerful jati in Jaffna.

their marriage if she had insisted and had waited some years. “No”, her father was very stubborn, she said. He would never listen to anybody’s advices. She told me that she missed the man she loved, but she wanted to forget him. She said that she had spoken to him only 10 days before the wedding, but since then, she had received no news from him. She said that she was unable to fight with her father about this issue; he had suffered so much for them. Devani told me that she did not see photographs of any of her potential husbands before her father decided whom she was to marry. She told me, “*What father decides is good*”. Her father had the right to decide everything concerning her wedding, she said.

When Devani could not marry the man she loved, it was related to the incompatibility of their horoscopes, but also to Devani’s status as a daughter. As argued by Daniel (1980), in the so-called ‘Chidambaram code’ which was prevalent among my Indian and Sri Lankan informants, and where women are seen as subordinate to men, a woman should in childhood be controlled by her father and brother, while in adulthood, by her husband and sons. This approach can also be found in the ‘Laws of Manu’¹⁰² which is the most important Hindu text on Dharma (duty or law). Children are seen as hierarchically subordinated the parents, and in particular to the father, and must abide their wishes and aspirations at all times while unmarried¹⁰³. It is also considered the father’s duty, or the brother’s if the father is unable or has passed away, to arrange a marriage for the daughters of the household. While Devani’s attitude as a daughter was ‘ideal’ in a conventional sense, her 21 years old sister, Radha had an attitude that strongly diverged.

Devani stated that it was her father’s right to decide whom she was to marry, and that it is a wife’s duty to respect her husband under any circumstances. A wife should adjust to her husband’s wishes even if it implied negative consequences for her. She told us that her father had taught them to be obedient and polite, to sit with their arms crossed with their hands on their elbows and with their heads bowed and downcast eyes. They should never answer an elder, and especially not a man. They should respect their husband and do as he says, no matter what. Radha on the other hand stated that she could never behave that way. She did not want to marry at all, and especially not an Indian. She wanted to be independent, and could not withstand the thought of being told what to do by a husband. She said, “*I don’t believe in persons*”. She did not believe that people were good by nature. On one occasion, while we watched pictures at Ramaswamy’s house, I asked Radha who sat on the floor when

¹⁰² In the Laws of Manu, it is for example stated: “Her father guards her in childhood, her husband guards her in youth, and her sons guard her in old age. A woman is not fit for independence” (Manu 1991:9 verse 4).

¹⁰³ Manu states: “As long as these three [father, mother and guru] live, he should not undertake any other (duties); he should constantly give them his obedience, taking pleasure in what pleases them and is good for them” and “For by treating these three in this way a man accomplishes what ought to be done; this is the ultimate duty right before one’s eyes, and any other is said to be a subordinate duty” (Manu 1991:2 verse 235, 237). Also, in the Kural, it is stated: “A man’s offspring are called his property, As their properties spring off him” (Thiruvalluvar 1990:63). The translator notes that the word property has a double meaning, where ‘property’ refers to ‘possession’, and ‘properties’ refers to ‘characteristics’.

she intended to marry. She shook her head, opened her eyes wide, and pretended to fall to the ground as if she was dying, in order to show her reluctance to marry. Ramaswamy, who was also present, but who did not see her expression or her shaking of the head, said to me that he planned to have Radha married as soon as possible. Radha's defiant attitude and her recurrent refusal to do what she was told occasionally caused her trouble.

Eventually, Ramaswamy agreed with a Tamil family of Jaffna origin to arrange a marriage between Devani and their son who was a resident in Canada. The dowry agreed upon was rather small, and the bridegroom's family even agreed to cover most of the wedding expenses, which is considered the responsibility of the bride's family. Ramaswamy on his side should pay for the *thali*, which is the pendant that signify a Hindu marriage for a woman, as well as Devani's journey to Canada. Paying for the ticket to the Western country is normally part the dowry when marrying someone living abroad.

DOWRY

Dowry is a problem for many poorer Sri Lankans. Many cannot afford the high expenses requested by families of potential spouses living in the West. During the last years, there has been a formidable increase in dowries, preventing a constant flow of capital between the systems of family network and obstructing one dowry to financing another (Fuglerud 1999). It is currently not unusual for dowries to exceed two million LKR¹⁰⁴, when one party lives in the West, and the other in India or Sri Lanka. The increases are largely due to the costs of illegal journeys which have drained off this capital to greedy travel agents. The high dowries prevent most people, especially the poorer and refugees in camps from getting their daughters or sons abroad, unless they themselves have a relative in Europe or Canada. It is also expected from the older sons, whether they live in Europe or elsewhere, to procure their sister's dowry before establishing their own family (Fuglerud 1999, Hoole 1997). This frequently has consequences on his economy, his status and who and when he will marry. The migrants have great economic obligations besides financing a sister's dowry. This may include supporting his family back home economically and settling own debts – for example for the costs of his own journey. International migration must in other words be seen as interactive with local dowry systems. In addition to expensive travel agents, personal qualities and looks are often decisive in determining the size of a dowry. One girl in Raja Nagar who had the advantage of being both very fair and very beautiful, qualities highly sought for among Tamils, had the misfortune of having lost half her hand in an SLA shelling. Her intermarried cousin, who was her only relative still alive, explained to me that he expected

¹⁰⁴ Between 950,000 to 1,000,000 INR.

people to ask for a very high dowry because of this injury. However, dowry is a much greater problem in India than Sri Lanka. News about wives being mutilated or drenched in kerosene and then put on fire by their in-laws due to dowry disputes was not uncommon (see e.g. Express India 1998.07.11, The Hindu 2001.02.19b, 2002.12.07), and frequently emphasised by Sri Lankans.

THE MARRIAGE AND FEAR OF LEAVING

Traditionally, future spouses were not supposed to see each other before the wedding itself, as it was deemed inauspicious. Today it is however usual to meet one's future spouse before the wedding, but only with other relatives present.

Devani and Kumaravel, her husband-to-be, got to know each other over the phone and spoke almost every day during the weeks leading up to the wedding. As the wedding approached, Devani had become more and more fond of him, and was looking forward to marrying him. A week before the wedding, Kumaravel arrived from Canada, and they took an instant liking for each other.

Two days before the wedding, at an auspicious time, the gold melting ritual was performed. This was held in the house which Ramaswamy had rented for Kumaravel's visiting family. In this ritual, a 22 carats gold coin is melted to a lump of gold. This gold nugget is eventually crafted to a *thali*. Rajkumar who performed the ritual for Devani and Kumaravel, told me that he could 'interpret' aspects of the marriage by watching how the gold lump melted, by observing whether any bubbles appeared during the process, and by examining at the shape of the ready melted lump of gold. Also by watching the crafting of the *thali* itself, aspects of the marriage could be revealed. By this, he could tell how the marriage was going to be, whether the firstborn was going to be a boy or a girl, and whether the bride or the bridegroom had had any previous intimate relationships. He stressed that it was important that the *thali* was made without interruption, as this could influence the marriage in a negative way. He told me that the nugget was well shaped after the gold melting ritual, and that it had no abnormalities. The process of crafting the *thali* was also successful, so the marriage would be a happy one.

The wedding ceremony was conducted in a rented, colourfully decorated wedding hall in Akhadipuram at an auspicious time. Around 400 guests, which was a rather modest number compared to many other Sri Lankan weddings in Akhadipuram, were invited to attend the wedding ceremony and the tying of the *thali*. Ramaswamy had rented a photographer, a film team, and an orchestra to play the wedding. In addition, he arranged with a Sri Lankan Brahmin priest who was frequently employed at weddings by the Sri Lankans in Akhadipuram, to perform the wedding rituals.

But soon after the wedding, Devani began worrying about leaving India. India was her home and all her family and friends lived here. She had conveyed this to Kumaravel, but got little sympathy from him. She told me that he had told her to stop crying and saying that she will miss her father and sister. Since she had him, she had no reason to weep. This had saddened Devani profoundly. Devani had little by little detected qualities about Kumaravel that she found disturbing. He was jealous and very possessive. He had complained about the way she dressed, and had told her

that she used too much makeup. Devani was also instructed not to speak to others without his permission. A while after the wedding, I was shown pictures from the wedding and from when Devani and Radha were small. While watching the wedding pictures, Devani suddenly said, “*It’s all a waste*”. I asked her what she meant. She said that she was happy where she lived. I asked her if she was worried about leaving India and going to Canada, and she confirmed that she was.

Intentionally, Devani was going to stay four months in Madras with her parents-in-law after the marriage, while Kumaravel was making his part of the paper arrangement so she could come to Canada. His parents planned to leave for Canada after two more years when enough money was saved for their journeys. Kumaravel’s father, Krishnakumar pointed out for me that it was more important for Devani to go to Canada than for them. While waiting for her papers to get in order, she stayed a while with her in-laws in Madras but returned back to Akhadipuram as she missed her father and sister.

The sentiments that Devani expressed are not exceptional. Moving out from one’s own natal family when marrying can be very difficult for a young girl. For the Sri Lankans, as in Devani’s case, it can in addition involve moving away from the country where one has grown up, and where one has all or most known relatives and friends. Suicides related to emotional anxiety and difficult family relations were not unusual among Sri Lankans in Raja Nagar, and it appeared to be more common than among Indians. Several Sri Lankans tried to take their own lives due to matters of love and marriages while I stayed in Raja Nagar. On other occasions, young people ran away or did not show up to their planned wedding. The problem of suicides among Sri Lankans was emphasised by both my Sri Lankan informants as well as by OfERR staff. Once a woman marries, she is no longer regarded a part of her natal family, but as a member of her husband’s family. But, it is nevertheless common for her to maintain contact and meet with her family of birth. But when meeting one’s natal family involves crossing international borders and paying much money in flight fares, it is more difficult. Family members are often scattered all over the world, and they rarely meet all at the same time unless there are special events, such as marriages or funerals. We can recall Sivanesan’s friend from the last chapter who had four brothers and one sister living in different countries. These reunited for the first time in many years following their father’s funeral.

ORGANISING THE JOURNEY ABROAD

The procedures of arranging Devani’s journey to Canada continued, but it turned out to be more complicated than expected. First, when her name was registered at the Marriage Registration Office after the wedding, her name was misspelled (“Devany”). This would lead to problems when applying for her visa to Canada, Ramaswamy explained. He believed the official had misspelled her name on purpose in order to earn some “extra” money. He said that it would cost him 3-5,000 INR to get this

problem sorted out quickly. Secondly, the process of getting the necessary papers for Devani's journey to Canada proved to be a real bureaucratic jumble. As a Sri Lankan, he had to apply to the Indian authorities for an 'Exit Visa' to leave India. For this he needed a Canadian visa which was only valid for a few months. Previously, when Sri Lankans wanted to go abroad, an application would be sent to the Foreigners Registration Office (FRO). Once it was accepted, the application would be forwarded to the local police who did their enquiry, and finally, if they recommended the application, the Collector would issue an Exit Visa. He said that now, after 1996, such applications would be sent to Delhi from the local FRO. This would prolong the process with many months. By the time they finished their procedure, the visa would have expired and one had to apply anew. In addition, there were problems to get a Refugee Certificate, which was necessary for getting an Exit Visa from the Collector. Ramaswamy said "*The Government had given Refugee Certificate only to those in the camps. Outside camp, there is no such Refugee Certificate for so many people. At the Tamil Nadu Collectorate Office, they ask you for your Refugee Certificate. When you say that you don't have any, they say you have to apply for one. Nobody knows how to get it. If you are not in the camp, you don't get it. I applied; I sent a letter to the Collectorate DRO¹⁰⁵. They should send it to Thasildar Office, the DRO's junior, to get a report from the area where you stayed about criminal offences. But now they don't know where the papers are. I have to go again after a few days and ask for them again*". He was very frustrated by the complicated and muddled bureaucratic procedures; especially that the papers now had to be sent to Delhi for consideration. While many used illegal agents in order to avoid more corrupt officials than necessary and to make bureaucratic processes go swiftly, Ramaswamy did not have the economic means to pay the large sums requested by an agent. It took Devani more than eight months to get her papers in order so she could leave for Canada.

The situation for the camp refugees was equally difficult. My Indian informant Kannan, who was well acquainted with refugee issues, told me about some of the procedures Sri Lankans had to go through when aspiring to leave India legally for a foreign country. Unless the Sri Lankans bribed officials, they could be sure that the procedures would either take too long time or they would not get the necessary papers done. Sri Lankans are also more vulnerable for dynamics of corruption – an aspect I will approach in more details in chapter eight. As many camp refugees had no passports, they had to get a so-called 'Emergency Passport' from the Sri Lankan embassy to leave the country. According to Kannan, the Embassy frequently took 'high prices' for issuing these temporary passports, which usually were only valid for three months. But, before being able to leave for Madras to apply for a passport, the Sri Lankan need to get a clearance from the Q-branch to leave the camp, which in itself can be a long process and which also often 'cost money', the latter of course varied from camp to camp. Once the person got the provisional passport, Kannan told me that she had to present it to the Q-branch, and then negotiate a price to get an Exit Visa. Thereafter, the papers

¹⁰⁵ Ramaswamy explained that the DRO was the District Regional Officer.

should be submitted to the Embassy of the Western country to which one requests to go. But to get a visa from them, you also need to submit a sponsor letter from a citizen of the respective country as well as a marriage certificate. However, the sponsor letter is only validated when you are married. These procedures often take more than three months and the Emergency Passport frequently expire during the process. In addition, he said that Sri Lankans have to pay 1-2,000 INR at the Marriage Registration Office, while Indians only pay 100 INR. Kannan said “*Lawful activity costs 20,000 rupees. This negates all the poor people*”.

JUSTIFYING MIGRATION

Before discussing the journeys to the West by means of ‘illegal agents’ and Human Cargo Traffickers, my informants’ perceptions of such travels should be clarified. Their lucid knowledge of breaking national and extra-national immigration laws and jurisdiction by travelling so-called illegally to the West does not necessarily implicate that they consider such journeys illicit or improper. Quite the contrary, few regard this as something ‘wrong’. I however argue that this perception is not a sign of contempt for national or extra-national immigration laws; it is simply a matter of regarding the validity of these regulations as irrelevant vis-à-vis their own motivations for improving their lives. Deeming such a journey right or wrong is not done on the basis of legal regulations, as these are often regarded unreasonable, arbitrary and impersonal, but on what they in specific contexts may rationalise. I will elaborate this by first presenting how Sri Lankans approached these laws and regulations. First, few if any observed any negative consequences resulting from their migration. Neither themselves, their family, nor people in their intended country of destination would, as they saw it, suffer from it. Among all my informants, it was only Garnet, who himself had lived in Holland, who disfavoured Sri Lankans going to Europe. He thought it was better for Sri Lankans to stay in India, but he also thought it was bad to send back the refugees: “*In my point of view, most of them are not asylum seekers, but money seekers. They spend so much money to go there, they can live well in India for that money [... But] civilised European governments should not send them back, whether they are asylum seekers or money-seekers*”. Though some, mostly people from Colombo, did not wish to leave for the West, they rarely had reservations against others doing so. The majority considered such a journey a great opportunity, which they saw no reason not to take if they had the chance. Secondly, many of my Sri Lankan informants thought it discriminating that Europeans could travel wherever they wanted, while they couldn’t. One informant also said that it was more difficult for a Sri Lankan to get

visas to European countries than for Indians because Sri Lanka was a “*refugee-producing country*”; he regarded this as very unjust. In addition, extra-national legal jurisdiction is also rather impersonal in form which, further enforced by its interpreted unreasonableness, made these laws difficult for many to relate to. When considering such a journey an option, personal considerations and perceived possibilities were hence given prevalence before national and extra-national legal jurisdiction.

The Sri Lankans’ perception of the validity of immigration laws and regulations as irrelevant is not only a matter of first, not being able to identify any negative consequences emerging from one’s migration and secondly, disqualifying immigration laws for their perceived unreasonableness and impersonality. There is also a more fundamental issue of personal representation involved which I will present below. But in order to understand the complex mutual incompatibility represented between perceived extra-national immigration laws and personal motivation within the framework of personal representation, one must view these factors in relation to each other and not as mutually exclusive and separate issues. I find Katherine Ewing’s (1990) argument useful to approach this association. But I will start by presenting a comparable situation or attitude often emphasised by many Indian informants, to elucidate my point. Many Indians do not, for different reasons, approve much of the sometimes massive influx of Sri Lankans into India. Reasons may, as we have seen vary between a general dislike towards Sri Lankans, the perceived Sri Lankan involvement with all sorts of illegal business, the LTTE’s assassination of Rajiv Gandhi, the increased prices in Tamil Nadu which frequently are blamed on the Sri Lankans, etcetera. Concurrently, the same people may see nothing objectionable about themselves going abroad for ameliorating their life situation, although this too may be done by judicially illegal means. As the Sri Lankans who are aware of immigration laws and regulations, but still do not regard migrating illegally as something illicit, this recurring Indian attitude does not necessarily represent a contradiction.

Ewing’s (1990) notion of ‘shifting selves’ can be useful in both instances. First, it reduces neither the above-mentioned Indian nor the Sri Lankan attitude to mere inconsistencies, and secondly, it considers personal motivation and perception on extra-national immigration laws within the framework of self-representation, while it simultaneously sheds light on why people may not sense them as relevant vis-à-vis each other. The prospect and identification

of an improved life (e.g. by means of wealth-acquisition) may for the Sri Lankan be conceived as totalising, justifying the implementation of the measures seen as necessary (e.g. migration to Europe) to reach the intended goal. As Ewing argues that people reconstitute themselves into new selves responding to internal and external stimuli, I maintain that the identification with the wished-for prospects of wealth and riches can be seen as one such stimulus.

As the different selves are, following Ewing's argument, context-dependent and mutually inconsistent, I argue that it is not a representation of inconsistency if a person does not accept others seeking similar life-improvements through migration as oneself. For instance, as an Indian you may have reservations against Sri Lankans coming to your country for whatever reason mentioned above. This does not negate your own wishes to improve your own life by means of migration. Such views, which most likely will be interpreted as inconsistencies from someone outside, should instead be seen as representations of shifting selves. The person will not see the Sri Lankan fleeing from the war as someone sharing his own prospects of improving his own life, but as someone representing qualities or attributes that he dislikes or that he interprets as threatening. It is therefore not a matter of contradiction, but of different selves with different motivations and aspirations coming to light in different situations. Similarly, extra-national legal 'unreasonable' and impersonal jurisdiction and own prospects for improving one's life by means of migration are represented by fundamentally conflicting value systems, and can therefore difficultly be incorporated into one experienced self. In other words, for these structures to be validated, not only do they have to be given prevalence, but they also have to be incorporated within the constituted self that aspires for a better future through migration. Given the fundamental discrepancy represented by these two, it is rather unlikely that this will occur.

CROSSING BORDERS - ILLANGO'S JOURNEY

People who got married in India and who were going to join a husband or wife in the West, as Devani for instance could travel lawfully when their papers were sorted out. But for others who did not have spouse to join and/or who chose to travel by illegal means, the journeys abroad could be risky and also very dangerous. In spite of the dangers involved, people frequently chose to travel illegally due to the difficulty in getting asylum or admission into a Western country by legal means. Differently from the Sri Lankans who sought to travel legally and who had to go through the extensive bureaucratic muddle of getting the necessary

papers and permissions for going abroad, illegal journeys could be arranged and effectuated rather swiftly as they frequently circumvented the intricate bureaucratic processes. Journeys arranged with the help of agents were very expensive, and could cost up to 25,000 USD depending on the desired destination. The illegal agents had connexions with international Human Cargo Traffickers, passport forgers, local officials and immigration officers, as well as immigration authorities in different European countries. It is here important to recollect Kannan's statement from the former chapter where he argues that immigration laws do not stop refugees from entering Europe, but that it only increases the rate for people, which again makes it difficult for poorer people to migrate.

The UK, Germany, Switzerland and Canada were commonly referred to as the most popular destinations. Journeys were frequently arranged by so-called 'agents', sometimes also in cooperation with relatives abroad. When using agents, emigration out of India was frequently arranged via Bombay, as certain people in the immigration had connexions to the underworld. These officers would safeguard a secure exit from India. Kannan told about numerous routes, most of them going through different countries in Asia and Africa, others through Russia. All these routes were controlled by the Human Cargo Traffickers, Kannan explained. The routes are multiple, complex and flexible and can be changed whenever problems arise (Fuglerud 1999). The journeys frequently involved complicated trajectories with many long stops in countries far away from each other. A route could for example involve stops in Singapore, Johannesburg and then Europe, but they could also involve countries like Laos, Cambodia, Kenya, Egypt or Ethiopia. As Fuglerud (1999) states, the agents are the only ones who know the planned travel trajectory, and who can reroute the journey when problems emerged at one of the temporary stops. The agent will report back to India whenever something unexpected happens to prevent others from experiencing the same problems. Sometimes people travel with a relative's Western passport, but frequently, many travel with forged or stolen passports. Sometimes, original passports are used in the initial stages of the journey, when it involves leaving India or Sri Lanka – as some of the journeys go via Sri Lanka – only to be changed to a forged or stolen passport in later stages of the journey. The passports are torn apart and flushed down the toilets together with the ticket before landing at the final destination. Though many European countries have introduced laws which penalise carriers bringing in undocumented aliens as an attempt to halt the increasing 'economic migrants' entering Europe (Chandrasanan 1989, Daniel and

Thangaraj 1995), airline companies cannot safeguard themselves against the procedures of destroying own travel documents on the planes. The destruction of travel documents protects the route, and ensures that you will not be deported to a country previously traversed (Fuglerud 1999). Laws, such as the Carriers' Liability Act in Britain¹⁰⁶ are however dramatic for the genuine refugees who were either unable to obtain valid documents due to the civil war, and who therefore travel with evident false documents. As Chandrahasan (1989) has documented, many countries treat the falsification of documents as a reason for refusing asylum, though this is in breach with the UN Refugee Convention of 1951. However, while waiting in some of the transitory stops, people may get locked into rooms for days at the time without papers, waiting for the final stage of the journey. There are occasions where their local contacts do not return. Refugees have been saved after screaming for help from inside a locked room after a long time without food. Sometimes people do not reach their intended destination. One Tamil I was told about paid a lot of money to human cargo traders to get to Germany, but eventually found himself in Kyrgyzstan. There are also stories of Tamil girls being raped and dumped in brothels, Tamils found dead close to borders in Eastern Europe, and Tamils being arrested and ending up in detention camps and prisons around the world. Others again may reach their destination, but are deported back to Sri Lanka because they are not found to fulfil the national requirements for asylum. This is often economically devastating for the sending family. When questioned by immigration officers, the travellers are therefore dependent on answering "correctly" on questions about human rights abuses, their backgrounds and history to avoid being deported.

What I just presented, are the frequent experiences of the migrants. But what also need to be elaborated are the consequences that such processes of migration can have on the families who remain in India. The case of Illango which I will now present, illustrates an attempt to migrate which – differently from Devani – does not involve marriage, and which in addition is done illegally. The attempt was unsuccessful, which had great consequences for Illango, as well as for his family. It was emotionally onerous for Jeyadhani, Illango's mother, and it also had considerable economic and social consequences for the family.

During my initial stay with Jeyadhani's family I got to know Illango, the youngest son of 17 rather well. Differently from his two brothers, Selvaraj on 21, and Ravichandran on 24, he proved to be very eager about going to Europe. After a long

¹⁰⁶ This law imposes heavy fines on the travel carriers for bringing in undocumented foreigners.

struggle, Illango got his parents' reluctant consent to leave. Jeyadhani however expressed much grief about being left by yet another child. Four of her seven children were already living in different European countries. The enquiries that followed to find a suitable and trustworthy agent resulted with a relative – an intermarried parallel-cousin of Illango. The journey was scheduled to August 2000, and the price was set to more than five lakhs INR. To finance the trip, Jeyadhani had pawned much of her jewellery, and borrowed some money from friends. Most of their relatives were reluctant to help. I was told that the money was supposed to go to the agent, to a new passport in Sri Lanka (his old had inevitably expired), to officials in the Sri Lankan passport control, to the journey to Europe, and to the immigration officers in his country of final destination. On the day of his departure, Jeyadhani was in tears, and Illango's father who was to follow him to Colombo to help him get a new passport, was very tense and nervous. From Colombo, Illango would go with another boy to a South-East Asian country, and then to Europe.

After some weeks, it was evident that something had gone wrong. From the South-Asian country, Illango and the other boy had returned to Sri Lanka. There had been some trouble with the immigration authorities in the country. They travelled together, but gave different reasons for entering the country, so the immigration authorities got suspicious. After some time, they made a new attempt to another South-East Asian country. The next thing I heard was that Illango had been imprisoned due to problems related to the agent's payment. I was later told that he had flown into an African country, where he had stayed for some time. But when he was about to embark the plane for the final journey, he had been arrested for possessing false travel documents and sent back to the South-Asian country, where he then was imprisoned. There were rumours that he had been tipped off to the authorities, as all the money had not been paid to the agent. I met Selvaraj, Illango's brother some weeks later. Illango had been able to telephone them. He told them that he was sharing a prison cell with 400 others. The food and living conditions were dreadful. Jeyadhani lost lots of weight during the following months as there were no more news from Illango, and the agent had told them that there was nothing he could do to help them.

The matter developed into a major family conflict. While Jeyadhani said that the agent had breached his promises, the agent's near relatives said that Jeyadhani had not paid the sufficient amount of money to get his son through the whole way. In addition, these problems became extremely expensive for Jeyadhani's family. The journey itself had cost more than five lakhs, and attempts to get Illango out of jail cost them an additional 260,000 INR. As Illango was a Sri Lankan citizen, his father travelled to the island to get help from the Sri Lankan authorities to get his son released, but in vain. The marriage of Jeyadhani's eldest son, intended to take place in India in January was postponed, mainly because of the expenses involved in seeking Illango's release. When the marriage finally took place, Jeyadhani's family asked for more than four lakhs in dowry, which was an excessive sum according to many of their friends and neighbours. The bride's family accepted, but not without pointing out the exuberance of their demand. Though much of this money was used to try to release Illango, he was still in prison when I left India eight months after his initial departure.

An illegal journey to Europe, as exemplified above, can be seen as representing a liminal condition. Liminality is by Turner (1967, 1991) described as a transitional condition between states, as the marginal and transitional process which is characteristic of rites de passage. Turner presents three distinct stages in his analysis: separation – detachment from an earlier fixed social structure; margin or *limen* – an ambiguous condition, inhibiting none of the attributes of the past or coming state; and aggregation – consummation of the passage. During this journey, the ‘illegal’ migrant finds himself in a position which is outside national borders and jurisdiction. In order to complete the transition from India to Europe, the person in question has to negate or erase his old identity. This must be done from the very moment he enters the airport in India. He must avoid making known the new identity he wishes to obtain, namely that of an asylum seeker. These two identities – the former and the intended – must be concealed until landing in the country of final destination. In other words, during the period of transition he is “betwixt and between” or “at once no longer classified and not yet classified” (Turner 1967:3).

During the journey, identity becomes a crucial factor, where external categorisation is a central issue. Jenkins (1996) argues that it is not enough to act out or “send a message” about one’s identity, it has to be accepted by significant others, e.g. national immigration authorities or any other legal sanctioning authority to be validated. As argued by Barth (1969), identities are found and negotiated at their boundaries where the internal and the external, or in this context the migrant and the legal authorities, meet. The migrant should avoid any sort of categorisation which may disclose his former identity, or his real purpose for travelling. Legal authorities in a country have the supreme power to define a person who crosses its borders and enters its territory. Power structures in processes of external categorisation are in other words decisive for identity construction. The liminal condition is represented by a negation, circumvention and a challenge of a whole set of established conceptions and regulations, including that which is legally acknowledged (Turner 1991). The traditional perception of ‘the refugee’ can for instance be negated by means of dressing. Fuglerud (1999) emphasises that many Sri Lankan Tamils who travel with false documents dress neatly in suits or other proper casual clothes, to avoid attention and to elude the traditional conception of the refugee, that of as a person dressed in rags. This can be related to the discussion in chapter five on how Sri Lankans in Raja Nagar negotiate refugee identities. Such a negotiation will always be performed within the framework of the dominant refugee discourse. Such a conception

permeates people's understanding of the 'refugee' and thus disciplines their approaches to this concept. Illango also acted within the discursive understanding of the refugee as the 'naked unaccommodated man' (see Malkki 1992) and tried to circumvent the classical refugee notion when he for example bought expensive, new and neat-looking clothes for his journey to Europe. But also national jurisdiction and boundaries are circumvented and disacknowledged by using forged travel documents and passports. This can be seen as a process of deterritorialisation, a challenge of the national state as a fixed entity with rigid borders including and excluding people. Finally, one's own identity is negated by simulating an 'ordinary traveller' until the final stage of the journey where the person tears up and flushes down the forged passport and the ticket. This can be seen as the stage where the liminal condition is terminated, where the person seeks re-entry into 'legal society'. Fuglerud describes this as the "last ritual act", which "is also the point of no return" (Fuglerud 1999:64). The person has eradicates all traces of his former identity and as well as of his journey, the *limen*. When arriving at his final destination, he must redefine and disclose his real intention for travelling and present himself in a way that will make him fit the immigration officers' conception of a person who needs protection. He must seek an advantageous external categorisation by the 'all-powerful' immigration authorities.

As so-called illegal migrants often travel together, as Illango did, they form a certain unity or 'community' based on a strong mutuality weighed against the legally established. In connexion with liminality, I find it useful to employ Turner's (1991) notion of *communitas*, which he describes as a social form alternating from 'normal' social structure. *Communitas* is literally a 'relationship between people', which emerge recognisably in the liminal period, but which is not limited to this phase. Turner (1991) presents this notion as a form of 'anti-structure', which is outside the orthodox classification of society where also personal relationships come before social obligations. The Beat Generation and the Hippies are presented as examples of such social units. The mutuality between so-called illegal travellers can be seen as a representation of *communitas*, with strong internal solidarity and own internal dynamics or terms lying outside national legal jurisdiction and order. It can be characterised as a 'secret society', which does not imply that it exists parallel or as an alternative to society, but that it challenges the established structures by having its own dynamics. But it is in fact also dependent on 'the established' to exist. The interpreted rigidity of national legal jurisdiction and borders are seen as a determining factor for the emergence

of this formation. While ‘members’ of this ‘secret society’ give the impression of being part of the established, they have other rules and obligations, hidden and undetectable to the outside world. In accordance with Turner’s (1991) argument, there are strong bonds and sense of commonality based on equality and mutuality between fellow ‘illegal travellers’; relationships that are not hierarchically structured. He maintains that personal relationships come before social obligations in *communitas*. But it must be argued that within all social unities – including the ‘secret society’ of the illegal migrants – there are strong social obligations and expected modes of behaviour. That is, all social units are structured, internally or/and in relation to the world ‘outside’. Breaking with such accepted and expected conduct can have consequences for the individual, as well as for the group. For the illegal migrants, it is paramount that their fellowship is not revealed to the outside. Turner states that “normative and ideological *communitas*¹⁰⁷ are symbolised by structurally inferior categories, groups, types, or individuals” such as Gandhi’s *harijans*¹⁰⁸, Tolstoy’s peasants or the hippies (Turner 1991:133). This can be seen as coinciding with the category of the illegal migrants. Due to their breaches with different national immigration laws, they are not well regarded, have low status, and have de facto few, if any, legal rights in the countries they have entered illegally. In *communitas*, “which dissolves the norms that govern structured and institutionalized relationships” (Turner 1991:128), the migrants are legally defenceless against exploitation and abuse from Human Cargo Traffickers, people they know they cannot trust, but whom they nevertheless are dependent on. Being in intermediate stages of the journey, possibly in an unknown country locked up in a room waiting for the next step of the journey, complaints about bad treatment, violence or even rape from Human Cargo accomplices cannot be done to local authorities without being disclosed as illegal travellers. This would break and reveal the ‘secret society’ and the secret identity of the illegal travellers, leading to a premature reinstalling into legal society. This disclosing and elucidation of their illegalities and breaches with immigration jurisdiction and border policies would imply a supreme process of external categorisation, where the travellers have little or no power to determine or influence the process of identity formation vis-à-vis the all-powerful state.

¹⁰⁷ The *normative* and the *ideological* are two of three *communitas* presented by Turner (1991). The last is *existential* or *spontaneous* *communitas*. The *existential* or *spontaneous* *communitas* is by Turner described as “what the hippies would call “a happening”, and William Blake might have called “the winged moment as it flies””. The *normative* *communitas* is described as when the *existential* *communitas* over time has developed the need to for social control and to mobilise and organise resources. The *ideological* *communitas* refers to a variety of utopian models of society based on *existential* *communitas* (Turner 1991:132).

¹⁰⁸ Mahatma Gandhi’s name for the *Dalits*, literally “the children of God”.

But if everything goes well when arriving at the intended destination, the migrant deliberately seeks reintroduction into the legal society, but on his own terms. At this point, he must negate all aspects of *communitas*, as well as his former self – the person he was before entering the liminal condition of the illegal traveller. If aspects of his liminal condition are disclosed, his intended new status or identity as someone who has the right for asylum will be challenged.

The asylum seeker is dependent on being categorised as a person who needs protection by the authorities in the respective country where he seeks entry. But the travellers are also susceptible for being exposed and defined as illegal immigrants, travelling with forged documents and therefore liable for sanctioning and for being sent back. Immigration authorities are often aware of processes and procedures used to enter Western countries by illegal means. This makes the process towards acceptance more difficult. This process is represented by an unequal power balance where the asylum seeker has no power and is in no position to define himself as someone who needs protection; his power lies in convincing the immigration authorities who have supreme power to define. The migrant can be seen as using counter-hegemonic strategies, where a presentation of self has incorporated legal structures, categories and regulations, that is, the premises of the hegemonic discourse, in order to promote his right for protection. As Roger Keesing argues; “the discourse of domination creates the objective, institutional realities within which struggles must be fought” (Keesing 1989:23). In addition, if a person’s request for asylum is rejected, he or she is not sent back to India where he may be safe even though this is the country he eventually departed from, but to Sri Lanka where he is liable to harsh treatment and interrogation by the authorities.

Differently from Turner’s (1991) argument, reinstalling is not merely a reintroduction into the society the person has left. When reinstated into legal society, the person not only is different, but he has to be different from the person he was before entering the liminal phase or initiating his journey. He is transformed. Such a change will still occur if his intended status is not accepted by the immigration authorities. As he most likely will be sent back to Sri Lanka, this will also mean a shift from the status which he previously had in India. The legal status and sense of safety of Sri Lankans in India can, relatively and with modifications, be seen as somewhat between Sri Lanka and a Western country. The sense of safety of Sri Lankan

Tamils (primarily from the north) which I believe is more significant on an empirical or experiential level than their *de facto* legal rights, can generally be seen as ranging from little in Sri Lanka, to partly in India and again to significantly in the West. This point will be elaborate upon further in following chapter, when I approach surveillance and corruption as significant aspects of the Sri Lankans' situation in India. Such a status and sense of security is of course shifting depending on the political situation in Sri Lanka, how different Western countries regard the political state of affairs in Sri Lanka and how they approach immigration issues.

CONCLUDING REMARK

This chapter represent a complementation of the former. The former chapter encompassed the structural patterns of Sri Lankan migration, of course with special reference to India. This included settlement patterns in relation to origin and caste, and local formations which emanated from these diasporic associations. It was important to localise the consequences of this trans-national economy for the Sri Lankan families, the Indian population as well as the local relationship between these populations, as an extension to the chapter which dealt with identity and local life in Raja Nagar. But it was also important to identify the distribution and negotiation of values and ideas that took place across national boundaries. Considering the Sri Lankans' situation in India, the construing of India as a temporary place for many people emerges as a crucial point. The many problems people had, which were related to the consequences of the assassination of Rajiv Gandhi, problems with the local population, or the difference in living standard between India and Sri Lanka made many want to leave India. As people could not return to Sri Lanka due to the conflict, many wanted to move to the West. The idea and the local construction of the West was based, not only on a dislike of India, but maybe more on the material wealth exposed by many people who had relatives abroad, the affluency of many of the visitors and on how media frequently presented the West. The 'imagined West' thus represents a basis for the dynamics presented in this chapter. Based on the structural characteristics of the Sri Lankans' situation in India, arranging a journey to the West was frequently represented by a set of organisational and familial problems and complications. As we have seen, migrating to the West may be distressing for a person who is leaving the country in which she has lived the largest parts of her life, and as presented in the case of Illango, the social and economic consequences may likewise be great for the remaining family, especially if difficulties emerge underway.

Having established many crucial social formations that represent the Sri Lankans' situation in India, it is essential to examine the structural imperatives which eventually lead to the redefinition of the Sri Lankans in India. In chapter two, I emphasised discursive interpretations rooted in the colonial transformation of the Sri Lankan society which eventually influenced the nature of Indian and Sri Lankan nationalist formations and these countries' historical developments. With this historical development in mind, the assassination of Rajiv Gandhi will be approached as determinant for the transformation and discursive demonisation of the Sri Lankans as a population in India.

Chapter 8 – The ghost of Rajiv Gandhi: The assassination and the transformation of the Sri Lankans in an Indian social order

“The event is not what happens. The event is what can be narrated”. (Feldman 1991:18)

“The Indian conception of the event was: ‘If Rajiv Gandhi would have been killed in Andhra Pradesh, no problem, but not in our house’” (Kannan, Indian Tamil activist and academic).

“We came to India from Jaffna on 20 May 1991. I remember the date very well; it was the day before Rajiv Gandhi was killed. I was very scared that something would happen to us, but nothing happened” (Madhiyarasu, Sri Lankan refugee).



It was the 21st May 1991, and the Parliament election in India was only a few months away. Rajiv Gandhi appeared to be winning an overwhelming victory, and was at one of his election rallies in the small town of Sriperumbudur, some 40 km from Madras. Resembling more a pop-star than a politician, he walked into the ecstatic crowd, leaving his security guards behind. Suddenly, the jubilant crowd was struck with

terror as a girl about to garland Gandhi violently transfigured into a thundering fireball.

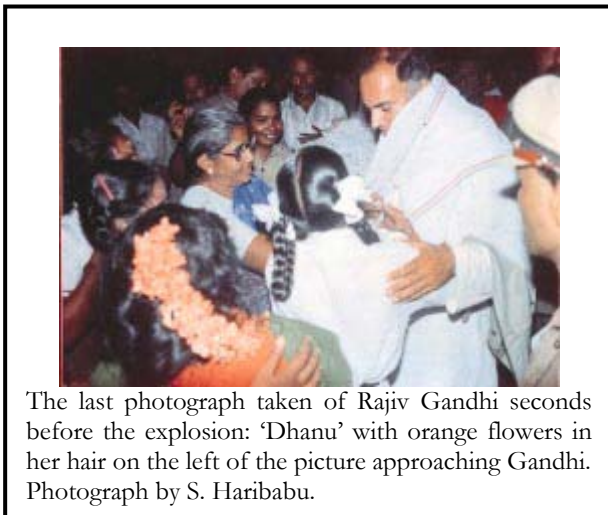

The last photograph taken of Rajiv Gandhi seconds before the explosion: ‘Dhanu’ with orange flowers in her hair on the left of the picture approaching Gandhi. Photograph by S. Haribabu.

The human bomb killed 18, including herself and Rajiv Gandhi and injured 44 others. One of India’s most popular political figures through all times was assassinated; Rajiv Gandhi had suffered the same fate as his mother. Large-scale investigation was instigated, and connexions were soon made between the suicide bomber and the LTTE.

The suicide bomber was later identified as ‘Dhanu’, a Sri Lankan who allegedly had been raped by Indian IPKF soldiers.

Eventually, 26 people were arrested and tried before court. A total of 41 people, many *in absentia*, including LTTE-supremo Prabhakaran were charged as accused. Of

the 41, 12 including the assassins were killed or committed suicide. 19 of the 26 people who originally were sentenced to death were later acquitted. The sentence was upheld for four of the accused in 1999 (Indian Express 1999.05.12).

INTRODUCTION

The assassination of Rajiv Gandhi had a significant impact on the status and adaptation of the Sri Lankans into the Indian social order. This chapter will more directly concentrate on the situation of the Sri Lankans in India in the light of the assassination, and represents in many ways a recapitulation of their situation in an Indian social context. As we have seen, many of the processes and conditions described in the three former chapters are strongly influenced by the implications and consequences of this event. The Sri Lankans' situation in India changed after the assassination, as they went from being well-received, and largely considered the victimised kin of the Indian Tamils, to being depreciated and looked upon as a community of 'potential terrorists'. The relationship to Indians on local level became strained, and the Indian authorities largely turned hostile to them. In other words, their situation and status became transformed following this event. But as the assassination in many ways has obtained a near totalising position in explaining this transformation, former damaging events and their implications has been overlooked. While a consideration of the impact of the assassination necessitates an understanding of this incident and its consequences in the light of former events, there is no doubt that the assassination was distinctively commanding regarding the redefinition of the Sri Lankans in India. Its consequences far surpassed the effects of for instance the shoot-out episodes in Madras and the emerging fighting between the LTTE and the IPKF, incidents that already had distorted the position of the Sri Lankan Tamils in India before 1991. Central in this chapter will be to investigate why this event, differently from former events, had such devastating impact on the Sri Lankans but without ignoring the influence of former events.

While pursuing an analysis of the assassination and the effects that it generated, it will be necessary to have a multileveled and multifaceted approach to encompass the complexity of the Sri Lankans' social transformation. I will commence this chapter by presenting the tangible political changes following the assassination which affected the lives of the Sri Lankans. Based in my empirical findings, I will highlight how the change of status and the political measures implemented by the Indian authorities came to affect the Sri Lankans' local comportment and how they construed themselves in an Indian environment. The

comprehensive transformation that not only the Sri Lankans underwent, but which took place on different levels within the Indian society, necessitates an approach on the assassination as an event which produces meaning in the world. Considering the assassination simply as an incident with instrumental consequences will neglect its symbolic meaning and the phenomenological dimension of the assassination. A significant factor in this transformative process is power. To grasp the assassination's multifacetedness, the comprehensive transformations should be seen as related to the discursive and disciplining dimension of power. This will reflect how political formations and general conductance on local level have been disciplined by a structural redefinition of the Sri Lankans.

POLITICAL CONSEQUENCES: STATE OPPRESSION AND SURVEILLANCE

The political consequences of the assassination emerged swiftly. The victory of the anti-LTTE politician Jayalalitha from the AIADMK in the State elections in Tamil Nadu was an early sign of this transformation. DMK, who were considered supportive of the LTTE, lost all the 29 seats they contested. In 1992, the Indian Government banned the LTTE and refugees were demanded to register with their local police. Those who refrained from doing so would be removed to Special Camps for eventual deportation, it was reported. The same year, India initiated a "voluntary repatriation" programme of Sri Lankans with the aim to "persuade and advise Sri Lankan Tamil refugees to repatriate" (SAHRDC 2002.02.25a:3). UNHCR were not given access to the refugees in the camps, and were only authorised to interview them at their point of departure after the refugees had signed a document agreeing to leave India (SAHRDC 1995). According to SAHRDC, many local NGOs¹⁰⁹ received "well-founded complaints that these repatriation documents are signed under coercion by officials of the Tamil Nadu Government" (SAHRDC 1995:9). According to the Indian Ministry of Home Affairs, a total of 54,187 refugees were repatriated between 1992 and 1995 (MHA 2002.03.01)¹¹⁰.

¹⁰⁹ Among them were OfERR, Asia Watch (Human Rights Watch Asia) and the US Committee for Refugees (USCR).

¹¹⁰ Due to the lack of access to the camps, UNHCR was also not able to ensure that the refugees were given the correct information about the political situation in Sri Lanka (Amal Raj 1997, SAHRDC 1995). Amal Raj (1997) also states that many left India because the conditions in the camps had become intolerable. According to SAHRDC – Asia Watch – an NGO engaged in matter concerned with human rights, criticised UNHCR for accepting its limited mission which "lend legitimacy to the repatriations while allowing the Indian government to bar UNHCR from fulfilling its protection mandate" (SAHRDC 1995:9). SAHRDC states that UNHCR also have been criticised for

On 27 May 1993, the Tamil Nadu government followed instructions from New Delhi and imposed a ban on all NGOs from working in Sri Lankan refugee camps. Nevertheless, OfERR were able to continue their relief work. It is now the only NGO 'approved' to work inside the refugee camps¹¹¹. The Tamil Nadu Rehabilitation Commissioner stated in a circular dated 1 June 1993 that the total ban on NGOs was for "the proper maintenance of the refugee camp" and to "ensure internal security" (Refugee Council 1999:13). Together with the ban on NGOs; doles and rations were stopped; education facilities for refugee children was halted; the repairing and maintaining of huts and lodging facilities within the camps were brought to a standstill; restriction of movement was introduced – preventing the refugees from going to work outside the camps; arrest and locking up of refugees in the Special Detention Camps started taking place; information on the political situation in Sri Lanka prior to repatriation was withheld; and sufficient medical assistance was restrained (SAHRDC 2002.02.25a).

In 1996, DMK's Karunanidhi won the state elections and took over as Chief Minister after Jayalalitha. He lifted some of the bans affecting the Sri Lankans, as for instance the ban on education. Nevertheless, people with no connexion to any militant groups continued to be detained in Special Camps under the Foreigners Act without trial (Amal Raj 1997), in spite of criticism from local NGO's and from the UNHCR. Additionally, a Naval Block was introduced, aiming to intercept and prevent the refugees from entering India by sea (see e.g. The Hindu 2000.05.19, 2000.06.02, 2000.06.11, Times of India 2000.05.14). As described initially in chapter three, the use of Naval Force and the permission to open fire at the fleeing fishing boats had devastating implications for many of the refugees who attempted to enter India.

SURVEILLANCE, FEAR AND CORRUPTION

"The Government gives a clear understanding: 'Sri Lankans are not welcome'. There is arbitrary arrest of youngsters since they are part of a terrorist community. The whole community is stamped as a violent community. The Government policy has implicit sanctions as corruption, naval block, arrest and detention of youngsters. This tells: 'you are not welcome as our brother, as an asylum seeker'.

their inability to protect the refugees once they reached Sri Lanka. They maintain that many of the repatriated refugees later returned to India, as they were unable to return to their native places due to combating, and many ended up in Sri Lankan refugee camps (or 'Welfare Centres' as they are named) instead.

¹¹¹ Even though OfERR have got consent to work inside the camps, I was told of several incidents where the Q-branch tried to restrain their entry into certain camps (OfERR staff, personal communication).

What happens is that the Indian Government's commitment to Human Rights and International Law is forgotten. The fate of the refugees hangs on an ordinary policeman's perception of law. No International Law is involved'. (Kannan, Indian academic and activist)

The killing of Rajiv Gandhi and the banning of the LTTE had extensive consequences for the Sri Lankans' lives in India, as may for instance be seen from the political development described above. These two incidents justified actions taken against LTTE and, thus, against people believed to have connexions to the banned organisation. Restricting the organisation's activities in India could only be fulfilled by an active and effective monitoring of the Sri Lankans, giving the Indian police extensive authorities to check Sri Lankans. Sri Lankans, on the other hand were scared to be linked with the LTTE due to the serious consequences that this would entail. This fear, alongside the increasing surveillance, had extensive consequences for their sense of security. With corruption already subsisting in Indian bureaucracy, the extortion of Sri Lankans who had committed petty crimes or who were simply scared of the police emerged as a serious problem. With restricted legal rights in India, they had limited opportunities or were frequently too scared to contest mistreatment or extortion by Indian officials.

SURVEILLANCE

The fears of the Sri Lankans were primarily directed towards the police and especially the Q-branch. The 'Q-branch' is a special branch of the Tamil Nadu Police, established for the purpose of detecting and arresting so-called anti-social and anti-national elements, movements or organisations such as the ferocious Naxalites¹¹². They are now also in charge of monitoring Sri Lankans, in order to detect and arrest suspected LTTE people in Tamil Nadu. Muthalingam, a Sri Lankan from Jaffna who had been living in India since the early 1980s told me: *"The Naxalites was a ruthless group. Therefore the police put up an equally hard group. They [the Q-branch] organised fake encounters to finish them [the Naxalites] off. They wanted to sustain the Q-branch, and got renewed significance when the Eelam¹¹³ problems emerged"*. Kannan, an Indian academic and activist maintained the following about their recruitment procedures and their activities inside and outside the camps:

¹¹² The Naxalites are 'extreme' leftist political factions in India who are infamous for their violent uprisings and many political assassinations.

¹¹³ Tamil Eelam, also referred to only as Eelam, is the homeland that the Sri Lankan Tamils are aspiring for.

“The Q-branch have informers who are taken up by the police in small offices. The Q-branch merge with people, and are never known as the police ... They [the Q-branch] arrest people for small crimes. They purposely look for them. They arrest and thrash them, and they [the criminals] become frightened. These are recruited as police informers ...”

“...After [the assassination of] Rajiv Gandhi, the Q-branch monitored LTTE actively ... They monitor the movements of the refugees, when they go in and out of the camps, they monitor the movements of outsiders and group activities inside the camps, in allowing people to go to other camps, relatives and so ... They [the Q-branch] give permits to go on pilgrimages, for transfer of camps, NGO activities, [and for] visitors from Sri Lanka and other countries inside the camps ... Outside the camps, you have to pay the police. The Q-branch keeps track on Sri Lankans and LTTE people. They tell them: ‘pay or I arrest you’”.

Due to their vicious and ruthless reputation, the Q-branch is much dreaded among Sri Lankans. When the Q-branch check people up, they may turn up in the middle of the night and sometimes also search people’s houses. They use informers to obtain information, occasionally also Sri Lankans. Alternatively, they may act as ordinary civilians in the local communities. Their officers are reportedly difficult to distinguish as they conceal their identity and operate as civilians.

Ambiga and Rajkumar told me about an incident with a former member of the LTTE who used to live in Raja Nagar. She was about to leave for Switzerland a couple of days later and had all necessary papers arranged when she was contacted by a man. He claimed that he too had been a member of the LTTE but had managed to get out. The man asked her to tell him her life-history, which she did. It turned out that the man was a Q-branch officer in civilian, and the girl was arrested and locked up in a Special Camp.

Many of my informants maintained that they had had problems with the authorities and especially the Q-branch¹¹⁴.

CORRUPTION

The ban on the LTTE and the consequent actions of restricting LTTE-activities in Tamil Nadu, by means of monitoring the Sri Lankans actively, eased corrupt formations to develop and to take root. The Sri Lankans emerged as an “ideal” group for whom corrupt officials could threaten, extort money from and arrest for false violations with little risk of disciplinary reprimanding. Though corruption was prevalent in Indian bureaucracy, it did not affect Sri

¹¹⁴ Even though the Q-branch have a notorious reputation, many Sri Lankans also spoke of friendly and helpful officers.

Lankans particularly more than Indians before the assassination. But after the assassination and the ban on LTTE, corruption and extortion became an extensive problem for them.

The Special Camps

People taken in for having LTTE links were as a rule arrested and locked up in one of the Special Camps. Such a fate represented a great fear for many Sri Lankans. There were numerous stories in Raja Nagar of Sri Lankans who had committed petty crimes or who had been involved in trouble unrelated to militarism who were incarcerated in these camps. The unclear motives for confining people and incidental fictional LTTE-cases made up by corrupt police officers against innocent Sri Lankans created an environment of suspicion and insecurity. As can be seen from the incident below, people considered as troublemakers by authorities could sometimes be moved out of the way or silenced by being locked up in Special Camps.

Velan fled Jaffna in fear of being recruited by the LTTE due to his background as a sports teacher. He came to India by boat in 1990 and settled in a local community, awaiting an improved political situation on the island. As this did not happen, he lodged himself into the Mandapam Transit Camp outside Rameswaram where he joined as a volunteer and worked with administrative affairs. Three years later, after the LTTE had been banned and the difficulties increased for the Sri Lankans, 42 families were involuntarily taken out of the camp to be “repatriated” to Sri Lanka (see chapter three). UNHCR complained to the Central Government who cancelled the deportation. The camp commissioner and the Collector were to bear the expenses. To finance this, subsidies, doles and shelter were taken away from the 42 families, upon which Velan protested. He and other volunteers collected rice from other refugees to supply the families with food. This was favoured neither by the commissioner nor by the collector. The former sent a message to the police accusing Velan for having connexions with the LTTE. He was arrested and taken to one of the Special Camps.

For eight months, he was kept inside one room the size of 6x8 feet, which included the toilet. He said that whole families were living together in some of the cells. He was given one pot of water (four gallons) each day for washing, bathing and drinking, and lived on very poor food. Velan told me that people in the camp were undernourished. During these eight months he was never outside his cell, but he could speak with the other inmates through the walls. After the initial eight months, the food improved and people were let out in the exercise yard for three hours every day. After one more year, people were allowed half a day in the yard. He told me that he wrote numerous letters, also to the President, trying to be released. He also got support and help from Amnesty, OfERR and the UNHCR who wrote letters to the Prime Minister. Even the dreaded Q-branch asked for his release as they claimed that he had committed no offences. Velan also offered to pay all his necessary expenses to stay in a specific regular camp, but the commissioner of rehabilitation who had

sent him to jail, and who needed to approve his release, rejected his plea. However, after the Human Rights Commissioner from Delhi visited the camp, and was confronted with the lack of proof and trial for his alleged connexion to the LTTE, Velan was released. This was in 1996, and Velan had been in jail for three years and six months. He saw his wife and children for the first time in six years. He told me that the commissioner, who had sent him to jail and prevented his release for all these years, now was retired, which facilitated his release. He said that among the 144 people who were in the camp when he was arrested, which also included children, roughly ten were LTTE-people. Most people in the camp had committed lesser offences such as passport forgeries. He told me, *“Even now, I am not fully recovered as I was earlier before custody. If I see a police, I hate him”*.

As people knew that such incidences took place from time to time, they usually kept a low profile and avoided speaking of sensitive issues relating to the conflict and LTTE. Such behaviour appeared to represent their general attitude, and was not only conducted towards me, but towards most Indians and people whom they did not know well.

Extortion and corruption

Corruption inside the refugee camps was well known, both among refugees and NGO staff. An Indian NGO-worker told me about an unofficial “price list” inside the Mandapam camp with “fixed prices” for different services from camp officials, for example if you wanted to leave the camp for work or if you wanted good housing facilities. He had a copy of the list, but was unfortunately unable to find it for me to see. He said that you could do almost anything in the Mandapam camp if you had the money, and the best way to stay out of trouble was to establish good relations with the camp officials. As corruption was not institutionalised in the same way outside the camps as it for instance was in the Mandapam Camp, “prices” outside could vary significantly. Corruption and extortion was not openly visible, but everybody knew that this existed. Sri Lankans perceived themselves as liable victims of corruption, only that they did not know when or if it would affect them.

Sri Lankans outside the camps spoke of two types of situations where they encountered problems with extortion from corrupt officials. This was when registering at the Foreigners’ Registration Office (FRO) and in situations where Sri Lankans had committed, or were accused of offences. They experienced increasing difficulties with registration when this became compulsory in 1993. Those who came to India before this received a refugee card which had to be renewed at the FRO every six months. People who came to India after 1993

did not receive such an identification card, but passport holders were given entry visas which they had to renew.

Aadalarasu, a former militant from PLOTE from eastern Sri Lanka said that the police usually asked him to return later when he went to register himself. They usually gave him reasons like the person in charge of registration was away, or the chief immigration officer was absent. He said that as soon as you offered them money, you got the necessary papers to register yourself. It was important to register in time, or you could run into serious trouble with the authorities. He said that the police seldom asked for money, you had to offer it to them. This was to avoid getting caught for bribery. Another Sri Lankan informant however said that police officers sometimes asked Sri Lankans directly for money when the police checked them or caught them for committing small crimes. He emphasised that Indian officials were scared to ask for bribes from other foreigners, because they feared they would make trouble. Sri Lankans on the other hand were too frightened to do anything else than pay.

In addition to the label of being potential terrorists, what made the Sri Lankans especially attractive for extortion was the availability of money. As we have seen, many Sri Lankans, especially Tamils from Jaffna, had extensive family networks in Western Europe, Canada, Australia and/or the Middle East, from whom they receive economic and material support. Sri Lankans were also frequently assumed by Indians to be wealthy which lead many house owners, before the assassination, to prefer Sri Lankans tenants. It was explained to me that the wealth of the Sri Lankans and the greed of many of these house-owners was a central reason for the increasing prices in Tamil Nadu, in particular on house rents. This was as we know one of the central matters of complaint on the Sri Lankans by the host population. Sri Lankans are now less attractive as tenants due to a recurring suspicion among Indians of Sri Lankans' involvement in illegal activities, and what is believed to be their liability to encounter problems with the police.

Indians and Sri Lankans in Raja Nagar emphasised that the police or the Q-branch frequently knew which Sri Lankans who had family in Europe. These people were expected to have easy access to money and were thus assumed to be able to pay large bribes. As assessed chapter

six, people's level of wealth was frequently also identifiable by the size of their houses. The prices that people were asked to pay varied with the seriousness of the claimed offence.

Jeyadhani's family had a camp refugee staying in their house for some time a couple of years before my fieldwork. This person had been out of the camp longer than he was permitted to, and the family had not registered the person with the Q-branch for staying with them, which was compulsory. The Q-branch showed up one day claiming two hundred rupees as a penalty for having the refugee staying in their house illegally. They paid the amount, and were left alone. Selvaraj, one of Jeyadhani's sons, said the amount was low because the violation was minor.

Serious offences, like those involving the LTTE could be costly, as the potential consequences for such violations if it was followed up in the legal system would be more severe.

In a situation briefly presented in chapter six, two of my informants ran into serious trouble with the police after one of their close friends for over 20 years, Arul, had informed the police that they had people with LTTE connexions coming and going to their house. Allegedly, Arul had got himself into trouble with the police after being caught for his involvement in 'shady businesses'. He apparently needed money to pay his way out of his problems. Like many other Sri Lankan families in the area, my informants had their own business where their customers primarily were Sri Lankans. Many of these customers supported the LTTE or had previously had links to the banned organisation, though this family did not. One night, the police came to their house and informed them that they had received information about their alleged LTTE connexion. The police searched their house, and found a photograph and a compromising letter which could be used to make a case against this family. The father was arrested, while the mother was told to produce three lakhs rupees (300,000) within two weeks or they would file an LTTE case against him. The mother was too scared to do anything else than pay. When I asked her why she did not contact a lawyer, she said that she believed a lawyer would ask for even more money than the police. She eventually sold all her jewellery, pawned valuable commodities and borrowed money from friends in the neighbourhood in order to collect the amount. The money was paid to the police and the husband was released, though in a poor condition after having been severely beaten in jail. They were also given back the photograph and the compromising letter, which was part of the 'deal'. The family received what they said was reliable information that Arul had received one of the three lakhs for tipping them off to the police.

A couple of weeks or so later, another family in Raja Nagar had a similar experienced. They were asked by the police to pay many lakhs of rupees or an LTTE case would be filed against them. Differently from what my informants had done, this family went to a local newspaper with details about what had happened, and with the name of the officer. An article was produced with a photograph of the officer, who eventually was reprimanded and transferred to another district.

The fear for Indian police and especially the Q-branch was also well known to the Indians in Raja Nagar. So was the knowledge of corrupt officers whom the Sri Lankans often had to bribe to avoid trouble. The disciplinary formations arising from the combination of surveillance, insecurity and fear and the Sri Lankans' vulnerability against repressive dynamics could sometimes be exploited. The following story, accounted by Ambiga, reveals what the consequences of such formations could be.

A Sri Lankan family used to live on the corner of my street. One late night a few months before I arrived in India, a big car of the type used by the Q-branch stopped in front of their house. They woke up the family and told them that they were from the Q-branch, and instructed them to pay large amounts of money or they would be arrested. The Sri Lankans were too scared to do anything else, and gave the people all their money in addition to lots of goods, kitchenware and other things. It was only later that they realised that these people were thieves, and had only pretended to be from the Q-branch in order to rob them.

Many wealthier Sri Lankans in Raja Nagar, such as Thirumal presented in chapter six, frequently also paid officials to "befriend" them and thereby avoided hassling and annoyance from them. Thirumal who lived abroad and who had bought land and house in India explained to me that as long as you paid the officials well they would not only leave you alone, they would also help you if you had any problems. Moreover, a family a few streets away from my house had visitors who were former members of the LTTE. These people should under normal circumstances be arrested and confined to Special Camps, but instead they engaged in friendly association with local police officers. Many Sri Lankans said that as long as you had money, you could do more or less as you wished.

THE SRI LANKAN MILITANTS AND THE Q-BRANCH

People's fear for being monitored by the authorities was first and foremost manifested in situations that were interpreted as sensitive, as in situations that could reveal illegal activities or a troubled background. People with backgrounds as militants had more to fear from the authorities than other. They generally appeared to be more secretive and evasive to me and other people they did not feel completely at ease with. Issues relating to their militant pasts were consistently evaded.

I got to know Murugan, the former LTTE man from Point Pedro rather well. He nevertheless remained evasive throughout my fieldwork whenever he spoke of his

time in the LTTE and about difficulties that he had had with Indian authorities. He nevertheless shared many experiences with me, but sensitive details were usually communicated when he spoke freely, without me having asked questions first.

He told me that the Q-branch had surrounded his house at 02.00 AM one night and arrested him. He was in prison for 10 days before being released. He said he went through hours of interrogation, and was only set free when he weeping managed to convince the Q-branch that he had been threatened to join the LTTE, and that he had managed to escape the movement after only a few months. He told them that he hated the Tigers.

Ambiga was a friend of Murugan and was present when Murugan told of this event. She said to me later in the evening, after Murugan had left, that he had been released because he had accepted an offer to report LTTE people to the Q-branch for money. He had revealed this to her on an earlier occasion, she said. She nevertheless maintained that Murugan never had turned in any Sri Lankans, even though he knew about quite a few LTTE-people in the area. She described him as a “cunning fellow”, but nevertheless a decent and honest person. Ambiga said that he had accepted the Q-branch’s offer just to be left alone. Murugan had told me he knew about at least ten Sri Lankans in Raja Nagar from rival militant groups who received payment from the Q-branch for turning in LTTE-people. He also believed that Sri Lankans from opposing militant groups had turned him in when he was arrested by the Q-branch. Murugan’s cousin Vijay who also lived in Raja Nagar also related about Sri Lankan informers working for the Q-branch. One of his friends had been arrested after having his background in the LTTE divulged to the Q-branch he said. He had been turned in by an EPRLF-man who lived in one of the refugee camps in the area. This man allegedly earned 2-3,000 INR per month for turning in former Tigers, and Vijay said that dozens of LTTE people had been arrested because of him. Though he lived in a camp, the EPRLF-man was often outside and had good connexions so he could easily find out whether people had links to the LTTE.

A couple of months after the conversation with Murugan, Ambiga told me that he had visited them with a “friend” from the Q-branch. The man had asked Murugan, Ambiga and Rajkumar if they would report LTTE-people to the Q-branch for money, an offer they all declined. Though Murugan now had so-called “friends” in the Q-branch, he was still scared of them. Murugan had told her that he had jumped over a high fence on one occasion when he recognised Q-branch officers close to his house. Though the Q-branch’s practice of using informers to apprehend militants in the camps was well known in OfERR, the existence of such dynamics in the local communities were unknown to them.

SIGNS OF MISTRUST AND ERASING HISTORICITY: FEAR, THE BODY AND PLACE OF ORIGIN

The Sri Lankans’ general level of fear and their attitudes towards their environment and the Q-branch nevertheless varied. This was largely related to geographical origin and experience, but also as we shall see to aspects such as bodily features. Some Sri Lankans, especially Tamils from Colombo or the Hill Country, were less familiar with the Q-branch’s surveillance and their occasional corrupt activities. Colombo Tamils were rarely visited by the

Q-branch, and were thus less scared and more outspoken about sensitive matters. This is of course related to the fact that few Colombo Tamils did have any associations with the LTTE, as the activities of the organisation were largely limited to the north-east of Sri Lanka. In addition, the wealthier Sri Lankans with transnational family networks were predominantly from Jaffna. These facts influenced the Q-branch' and corrupt officials' conductance towards the Sri Lankans. People belonging to the fishing community of the Karaiyars, who had their origins from weighty LTTE-areas around Point Pedro and Valvettithurai were prone to be taken in for interrogation and were often suspected for having LTTE connexions by the authorities.

Marks on the body could also be a source for social categorisation. One of my informants, Dharmalingam was a Karaiyar from Valvettithurai. His origin would in it self make him a suspicious person for the Q-branch, but the fact that he also had several bullet wounds made him more vulnerable. He told me the Sri Lankan army soldiers had shot randomly at people one day he was cycling in his village. One bullet went through his right arm, another grazed his waist and a third went through and his hair but did not hit him. He and others told me that people with bullet wounds or other injuries that could have come from combating were almost certain to be suspected for being militants by the Indian authorities. Dharmalingam had had problems with the authorities due to this. When I asked him if he could tell me about some of these experiences, he was reluctant "*I was inquired for one year. I had many bad experiences but I don't want to tell about it. [...] It is not good to complain about Tamil Nadu because we are living here*". He however stressed that he had never had any connexions with the LTTE, and he spoke of the organisation with great dissociation, avoiding sensitive issues which could somehow link him to them.

The frequent fear and reluctance to speak about sensitive matters was underlined by Aadalarasu, the former militant from PLOTE. Even though he knew me well, he told me that he could never be 100% sure that I did not have any connexions with the Sri Lankan Government or with the Q-branch. He expressed what many insinuated, that you could never trust a person fully. As we saw from the case of my two informants who were turned in to the police by their friend Arul, even trusted people could turn against you if their own situation turned precarious and they became desperate. Fear was in other words always latent.

Most people chose to be on the safe side and did not speak of anything that could eventually backlash on them.

There were nevertheless exceptions, even among the Karaiyars. Sonali, from Point Pedro, whose family I presented in chapter six, for instance spoke openly about her family and of her family's close involvement with the LTTE. But even she was not initially comfortable. She felt insecure about my translator who was from Colombo. She however loosened up, and even became so explicit and loud-voiced that we had to ask her to keep her voice down so that the Indian neighbours should not hear her pro-LTTE and anti-Indian outbursts.

Surveillance and the fear of the authorities were not only restricting what people would say, for Murugan, surveillance was also restricting his actions. He had done karate for many years in Sri Lanka, but could not continue this in India. He said that a Sri Lankan doing martial arts would attract attention and make the Q-branch suspicious. The fact that he also was a former LTTE-cadre strengthened his vulnerability towards the Indian authorities.

Signs of mistrust

All these aspects: bullet wounds on the body, place of origin, performance of martial arts can be regarded as significant signs that generate meaning, and contain multiple possibilities for interpretation. Their potentialities should be seen in the specific locality where they prevail; Tamil Nadu and India. The case of Dharmalingam is interesting in this regard: he is both from Valvettithurai as well as his body was marked from the armed struggle. His body is a marker of experience and a mediator of history with the potential to aggravate his already difficult situation. That is, he encapsulates two signs which in combination are mutually influential and ultimately restricting his comportment. However, due to the politicization of the Sri Lankans and dominant Indian discursive formations – which I will approach in details later in this chapter, such signs tend to assume highly charged politicised interpretations, of something illegal and ‘disqualified’.

Peirce' presents the following 'semeiotic triangle': sign, interpretant and object. He states: "A sign, or *representamen*, is something which stands to somebody for something in some respect or capacity. It addresses somebody, that is, creates in the mind of that person an equivalent sign, or perhaps a more developed sign. The sign which it creates I call the *interpretant* of the

first sign. The sign stands for something, its *object*' (Peirce in Daniel 1984:14). The interpretant is not the interpreter of the sign, but rather the interpretation, or the idea that is produced with the receiver. This interpretation will not be identical with the initial sign. In order to explain the meaning of a sign, one does not need to refer to the object which the sign represents. This can well be done by referring to another sign, which again must be explained with yet another sign. The interpretant must thus be regarded as a new sign that will breed a new interpretant. The interpretant is an interpretation or a conversion of a sign, and is thus more than a synonym. For this interpretation, we must employ other signs, which again will be interpreted by new signs, and so on (Daniel 1984, Heradstveit and Bjørgo 1996). The object, in spite of its empirical quality is not necessarily material, it may well be ideas and conceptions, or as Daniel puts it: "that towards which one's attention is directed" (Daniel 1984:18). While objects may exist as empiricities or facts in the universe *per se*, they do not become real before they are represented by a sign, which representation is interpreted as such by an interpretant.

Dharmalingam's origin and wounds are signs that are interpreted in a specific manner in the Indian context, but are also the results of a set of other interpretants and signs. For the Q-branch, locating wounds is a common way of detecting militants. The star shaped wounds Dharmalingam possesses are interpreted as bullet wounds. This new sign is regularly interpreted to signify a link to militants. His village of origin, Valvettithurai, does also become a significant politicised interpretant, as Valvettithurai in general is contemplated as a nexus for the LTTE. The bullet wounds and his origin from an LTTE stronghold become two separate but mutually reinforcing signs, generating an interpretation of him as a likely LTTE man. As Daniel (1984) argues, several correlates may be entailed in the sign relationship, but all these correlates need not have the same configuration or significance. For instance, his bullet wounds would not have been subject of such an interpretation had he been a Bangladeshi or a Nepali, or even a Sinhalese. Sri Lankan Tamils as possible conspirators to the assassination is an interpretant of that of being Sri Lankan, and has in itself become a sign, where physical marks, specific origin etcetera are being evaluated as new interpretants.

Erasing historicity

By approaching origin and bodily marks as signs, one may identify the way in which these are interpreted by various people, in the context of specific localities, and with reference to

inherent formations of power. For the Sri Lankans however, the bullet wounds do not necessarily signify militancy. The interpretant may well simply be 'closeness to the war'. The large majority of the Sri Lankans from the north experienced excessive violence with the armed struggle, though they did not necessarily get physical wounds from shelling or gunfire. Such comprehensions will however have little or no influence on dominant Indian conceptions. Within dominant and discursive formations, interpretations of such physical signs, places of origin or 'suspicious' practices such as karate, overrides the Sri Lankans' personal experiences. A central feature of discursive formations is the disqualification of challenging or 'heretic' conceptions (Foucault 1999a). Though the Q-branch or the Indian authorities perform interpretations of individualised signs, these are based within a dominant discursive framework, which in effect repress or erases historicity and the Sri Lankans' individual experiences. Historicity is the individual capacity, by means of its existence and actions, to generate dispersal, difference and alterity in time and space (Feldman 1991:18). Within a discursive framework, history is politicised and selectively construed, and frequently also conceived as linear.

FEAR AND BEHAVIOUR

Thus, the Sri Lankans' fear permeated their conductance in a disciplining manner. The reproduction of fear was not only a result of experienced surveillance or corruption, but also of an acknowledgement of oneself as someone vulnerable, as a potential victim of repressive dynamics. As in the example above, Dharmalingam was aware that his wounds (as a sign) would generate interpretants that could be potentially repressive. Dominant Indian discursive formations have become evident for the Sri Lankans, due to the 'legitimation' of repressive formations as a mean to impede LTTE activities. However, this uncertainty was born out of a collective and not an individual identification, where power stands central. It was a product of being a Sri Lankan in India, an identity that has been shaped and renegotiated through processes of internal and external ascription. Such processes took place both on local level as presented in chapter six, but also on structural level, in relation to the state, which is an argument I will pursue throughout this chapter. As briefly accentuated above, power should be understood in a Foucauldian sense, where power is circular and not in anybody's hands. It is exercised through a net-like organisation where individuals at the same time undergo and exercise power. While the Sri Lankans may be suffering under these

mechanisms of power they are simultaneously its mediums. In other words, they are the elements, and not the points of its application (Foucault 1980).

This negotiation of power must be seen in relation with a transformation of the Sri Lankans after the assassination, where they came to represent a category which generally was attributed negative and often dangerous qualities. On occasions where Sri Lankans protested against or confronted corrupt officials, and where policemen were reprimanded, the dynamics of fear which were products of disciplinary formations were challenged. However, as have been described, the Sri Lankans practices and behaviour were in general altered after the assassination due to dominant discursive formations of power. As I will argue for in more detail in the upcoming part, certain events, dynamics and practices should be seen as 'violent' and transformative. It should however be maintained, following Feldman (1991) and Appadurai (1995), that new subject positions, and this concerns the Sri Lankans as much as the Indians, are constructed and construed by violent performances. Former ideological and contextual motivations are rendered unstable after such "mutations of agency" (Feldman 1991:20). This leads us to the assassination itself, and its intrinsic transformative character.

TRANSFORMATION OF THE SRI LANKANS

Political actions against the Sri Lankans and dynamics of surveillance and corruption emerged after and as a consequence of the assassination and of the banning of the LTTE. The banning of the LTTE is crucial in this context, as it can be regarded as a rationale for the severe approach on the Sri Lankans by the Indian state. Without banning the organisation, effectuating the repressive measures would be difficult. Many incidents before the assassination had already aggravated the relationship between Sri Lankans and Indians, but none had the impact of the assassination. This event fundamentally and irreversibly transformed the way the Sri Lankans perceived their situation, but also how Indians perceived them. It is important to examine the reasons why the assassination, contrary to prior events, had such comprehensive implications and resulted in such an extensive transformation of the Sri Lankans' status. To understand the full impact of the assassination, one must not only consider the tangible political processes and personal experiences that emerged, but also grasp the symbolic and phenomenological dimension of the event.

I will use a threefold approach to examine the impact of the assassination: Appadurai's (1995) phenomenological notion of *locality producing events*, Victor Turner's (1967) concepts of *liminality* and *rites de passage*, and Mauss' (1990) intellections on '*the gift*', with special emphasis on *reciprocity*. These three approaches will be used to portray different, though complementary facets of this transformation. I will start by introducing Appadurai's argument, and continue with an approach on the assassination as an event that inaugurated the structural transformation of the Sri Lankans. This will be done by means of Victor Turner's concept of liminality. While Appadurai's notion is essential to understand the assassination's phenomenological dimension, as an event with extensive transformative potentials, the explicit transformative impact of the assassination on the Sri Lankans, I believe, is in this context better encompassed with Victor Turner's theory. Appadurai's approach will then be employed to examine the violent effects of the assassination (on India and Indian soil) and of the consequent retributive acts (on the Sri Lankan population in India). From an Indian point of view, I will argue that these retributive acts are 'necessary' as they are exercised in order to reinstate a distorted balance. To grasp the comprehensiveness of this retribution, I will use Mauss' concept of reciprocity. Finally, I will return to Turner's notion of liminality and the transformation of the Sri Lankans. I will suggest why the status of the Sri Lankans eventually became, and remained transformed.

The sequential structure chosen for this part is not arbitrary, as I believe it portrays the transformative process of the Sri Lankans. It commences with the assassination as the event that inaugurated the transformative process, what I will argue is the entry into the *liminal*, and ends with the retributive acts that emerged along with the reinstatement of the Sri Lankans into an accepted social order.

THE TRANSFORMATIVE DIMENSIONS OF THE ASSASSINATION

The assassination was an extremely traumatic event in India. First, Rajiv Gandhi was an enormously popular politician, and people had hopes that his re-election would put India 'back on the right track'. He was also part of the Nehru-Gandhi family, which is the closest you get to a royal family in India. Secondly, the act was tremendously violent and cold-blooded. Not only was Rajiv Gandhi and the human bomb killed, but also 17 other people. Thirdly, the assassination seemed irrational to people, which strengthened the perceived cynicism and cold-bloodedness of the act. The only motive people could think of was to

avenge the disastrous IPKF-operation, but such an act of revenge would not benefit LTTE in any way. People, Indians as well as Sri Lankans, repeatedly stressed how unwise it was of LTTE to kill Rajiv Gandhi. LTTE has also never officially admitted that they committed the act. The incomprehensibility of the act, the lack of evident motivations and apparent irrationality also leaves it empty of meaning. The act however produces meaning by means of its extreme violence and by the emotions that it generated.

The transformative dimension of the assassination can be highlighted by regarding it as a locality producing act. Locality in this sense is not localised or spatial, but is relational and contextual. Appadurai describes it as “constituted by a series of links between the sense of social immediacy, the technologies of interactivity and the relativity of contexts” (Appadurai 1995:204). Neighbourhood, on the other hand refer to situated communities and actual social forms in which locality can be realised. Thus, the production of locality is a process of creating meaning and coherence in places. This may be done by means of naming places, making, remaking and protecting of fields and gardens, ritual performances as well as by a demarcation of public and private spaces. Such performances produce what Appadurai calls local subjects, actors who belong to situated communities. Locality involves material and symbolic dimensions, as well as a human dimension: that is, human experiences and social positioning, as for instance status relations and social identities. Locality is a phenomenological dimension of social life, produced by human activities with specific material effects. I argue that the assassination represents such an activity. However, and following Appadurai’s argument, I argue that the transformation occurs within two different and counteracting processes, and not only one. The first being the assassination, while the second are the retributive acts instigated by the Indian government against the LTTE and the Sri Lankans. The violence represented in both these acts transformed Sri Lankans’ situatedness in India and their relation to Indian Tamils and the Indian State. The assassination and the authorities’ retaliatory acts, I argue can be compared with a ritual performance or, as I will contend below, more specifically a *rite de passage*. The Sri Lankans, by means of the acts are ostracised, transmogrified and reincorporated into the situated community.

Liminality and the transformation of the Sri Lankans

A facet of the transformation was that it implied a period of prevailing uncertainty among the Sri Lankans. This was a period of transition where one dominant understanding of the Sri Lankans and the LTTE replaced another, both on the national level and among Indian Tamil on local level. Within the time frame of this transition, old and new emerging conceptions overlapped, creating an intermediate state of liminality. With reference to chapter seven, liminality represents a transitional condition between states – state, in the sense of a “relatively fixed or stable condition” (Turner 1967:1). The immediate aftermath of the assassination, I argue, have liminal attributes, where the assassination symbolically marks the inauguration into the *limen*. It is in other words here, at these intersections that the phenomenological and transformative dimension of the assassination and the retributive acts, as events that produce meaning, come into play. The Sri Lankans’ previous, but already decreasing status in India as the ‘victimised kin’ was drawn to a final conclusion with the assassination. It is however important to note that this conclusion was only realised in retrospect, once the LTTE were identified as the assassins.

After being symbolically “removed” from their previous status, the Sri Lankans awaited to be redefined and symbolically reintegrated by the Indian authorities and public. For some time, the Sri Lankans found themselves in an erratic situation characterised by great fear, not knowing their place in the Indian society. This can be compared with Turner’s (1967) liminal condition where one no longer is classified, and simultaneously not yet classified. Their status had an anomalous quality which placed them outside an accepted social order. However, another locality producing process, namely the government’s retributive acts, needed to take place before they were to be fully reintegrated into an accepted Indian social order.

The assassination as a locality producing event

Now, returning to the phenomenological dimension of the assassination. Spatial production of locality always involves a moment of colonisation of the territory in question, and involves an aspect of violence, which in itself is transformative with respect to the soil (Appadurai 1995). Following Appadurai, the assassination, I argue, colonises the Indian (or Indian Tamil) soil with its extreme violence. It is not only transformative in character, but also demonic in its disposition. Demonic, in the sense of being aggressive, destructive and deterritorializing, it erases former meaning and leaves behind a chaotic condition. As already contended, this

condition is in effect liminal. In order for the Indian authorities to regain control, or to recreate balance if you will, the demonic needed to be contained and controlled. This could be done, or attempted to be fulfilled by what I would call a counter-violent performance, by taking severe and violent action against the demonic, represented by the LTTE. The LTTE was banned and Sri Lankans were ascribed potential demonic qualities and were arrested in masses. They were subsequently sought controlled by means of extensive surveillance and by initiating a set of restricting institutionalised measures. These were for instance the incarceration into Special Camps of Sri Lankans who failed to register with the police after the assassination and the instigation of a comprehensive system of registration for all Sri Lankans. The incarceration of people into the Special Camps was thus both a process of re-localising and an inscription of violence on the Sri Lankan population.

Retribution of and 'levelling out' the assassination

The comprehensiveness of these retributive acts may be drawn attention to by seeing these acts in relation with Mauss' (1990) intellections on 'the gift'. Mauss' criticises utilitarianism¹¹⁵, and argues that there is no such thing as a pure unintentional gift; there will always be a motive behind an act of giving. Mauss' presents a threefold set of obligation in the process of giving: to *give*, to *receive* and to *reciprocate*, and underlines the power that lies in a gift which makes someone obliged to reciprocate. By not accepting a gift, you may insult the giver¹¹⁶, and by not returning a gift, the initial receiver will obtain a position of inferiority (Mauss 1990). All gifts will be part of a system of reciprocity, where the giver and the receiver's honour are linked together. A gift can thus be regarded as a cementation of people's relation to each other (Douglas 1990). I argue that the assassination, or more specifically the retributive acts, can be related to Mauss' notion of reciprocity. But I should first emphasise that though I see the usefulness of the notion of 'reciprocity' in this context, I find the other two: 'giving' and 'receiving' problematic. Though both the assassination as an act and giving a gift indeed create a sort of inequality when effectuated and thus invite some sort of retribution, overstating their similitude is needless to say problematic. The same can be said about the notion of 'receiving' as the assassination was violently imposed, and not accepted as an honourable act, as would have been the case of Mauss' 'gift'. Returning to the notion of

¹¹⁵ A concept that holds that the good and right acts yields the greatest utility.

¹¹⁶ Mauss for instance maintains that not accepting a gift among the native Kwakiutls in North-Western Canada is equal to a declaration of war (Mauss 1990).

reciprocity: these 'counter-violent performances' can be seen as an attempt to re-establish a sort of equilibrium or to regain the upper hand; in other words, an attempt to nullify the imbalance created by the assassination. However, the perceived inherent terror of the assassination could not be levelled out by these acts: Rajiv Gandhi *was* dead, the LTTE could not be eliminated and Prabhakaran could not be caught. And the wounds of the assassination would not be obliterated as long as the LTTE, the symbol of this terror, was not annihilated and Prabhakaran was free. Such a trajectory would only be realised by India's re-entry into the Sri Lankan quagmire. Considering India's devastating experience in Sri Lanka a few years before, this was not going to happen. Hence, as the inherent terror of the assassination could not be levelled out by these 'counter-violent acts', these had to persist. The Indian counter-violent acts would remain an unfulfillable endeavour for equilibrium.

The new status of the Sri Lankans

Having this in mind, it should be clear that the status of the Sri Lankans, once they came to be reincorporated into an accepted Indian social order, differed largely from the one they possessed before. Turner argues that the content of the different stages in 'rites de passage' are distinct, an approach criticised by Bloch (1993). Bloch argues that the transcendental (which is a feature of the liminal) is not left behind when returning to normalisation in ritual processes. The transcendental continues to be attached to the person in question; its value is not negated. This feature can be paralleled with the Sri Lankans in India. The demonic permeated assassination which represented the liminal or intermediate stage became an appendix which they were to be associated with in the future. This is also in accordance with Bloch's argument that "...the return to the here and now is really a conquest of the here and now by the transcendental" (Bloch 1993:5). Following Bloch's argument, the "here and now" is the Sri Lankans' new status. This is a resituated and redefined status that also emerged alongside a new national conception on the LTTE especially, and on the Sri Lankans generally. This reincorporation thus also involves a transformation of meaning. The Sri Lankans are attributed certain features and qualities on the basis of the violent transformative event of the assassination and the Indian authorities counter-reactions. The new status of the Sri Lankans after the assassination was transformed, and they became demonised as a community of potential terrorists (see also Amal Raj 1997, Bastiampillai 1996, Suryanarayan 1996, Suryanarayan and Sudarsen 2000).

DISCOURSE AND TRANSFORMATIVE REPRESENTATIONS

In order to comprehend the assassination's tremendous impact on the status of the Sri Lankans in India I have now described the phenomenological dimension of this event. But while having described the transformative process, where they went from being the "victimised kin" to a "community of potential terrorists", the aspect of power has not been properly approached. As we have seen in the initial sections of this chapter, as well as in proceeding chapters, repressive and disciplining dynamics produced and reproduced a climate of fear and suspicion among the Sri Lankans. The objective in the following part is thus to elucidate how such dynamics could emerge and also how they 'operate', viewed in the light of the assassination. With this task in mind, I will approach power structures as discursive and disciplining formations. However, as such formations do exist on a range of levels, I will present their various expressions, which in one way or the other influence aspects related to the Sri Lankans in India.

Hence, the assassination had impact on all levels of the Indian society that in one way or the other were related to the Sri Lankans or the LTTE. In order to identify the comprehensiveness of this event on various levels of Indian society, I find it useful to use Foucault's concept of discourse. With this concept, I wish to demonstrate how certain notions, which in many ways are defining for the Sri Lankans in India have become dominant while others have become illegitimate. The discursive formation that I am about to present have influenced Indian politics towards the Sri Lankans, Sri Lankans' general comportment and behaviour, and eased the emergence of the repressive dynamics described initially in this chapter. In Foucault's terms, discursive practices are rule-governed structures of intelligibility that oblige people to behave in a given way and give consent to ways of behaving. These discursive formations are not imposed by figures of power, but are embodied and taken for granted. These formations may speak of rules, though not in a legal sense, but normatively where codes of normality are defined (Foucault 1980). Within a discourse, certain notions emerge as valid, while others are considered illegitimate and disqualified by means of various mechanisms (Foucault 1999a). In order to grasp the development of discourses, Foucault stresses that one should not look at things only on one level, that of the event, but acknowledge that there is a whole order of levels where different types of events differ in amplitude, chronological breadth and capacity to produce effects (Foucault 1980:114). However, it is beyond my scope to localise and investigate the historical factors involved in

the formations, alterations and breakdown of discourses, which is a central objective for Foucault. My objective is instead to identify the existence of such discursive formations and to localise the inherent dynamics of power that classifies, excludes and includes.

I will outline three different levels in India, each with different prevalent representations of Indo-Lankan relations. These representations play a significant role in relation to social formations and dynamics of power regarding the socio-political situation and status of the Sri Lankans in India. The two first are structural and prevail on Indian national level and on state level in Tamil Nadu. The last appear on local level and relate to the Sri Lankan Tamils' own conceptions of their situation in India.

INDIAN NATIONAL DISCOURSE

On this first level I will argue for the existence of a dominant national discourse which relates to the unity and preservation of India, its national borders and its democratic and federal political system. This discourse, I argue must be seen in the context of India's conglomerate of ethnic and religious groups¹¹⁷. The Congress Party which came to power after independence saw it as fundamental to maintain the rights of all populations in a socialist and secular democracy within a union of states in order to preserve this fragile unity. This became, and still is, normatively a fundamental social principle in India (Khilnani 1997). The Indian democratic project can largely be viewed as an ideology. The establishment of the country as the world's largest democracy is in India often conceptualised as a milestone in history: "...the history of independent India appears as the third moment in the great democratic experiment launched at the end of the eighteenth century by the American and French revolutions" (Khilnani 1997:4). The democratic principle is frequently contrasted with the inherent inequality of the caste system and the authoritarian princely states that prevailed during colonial and pre-colonial times, but also with many of India's neighbouring states (see e.g. Khilnani 1997). With the exception of the war with Pakistan in 1971 which resulted in the establishment of Bangladesh, India has consistently opposed separatism in the region. Threats to the security and stability of any of India's neighbours have been viewed as a threat

¹¹⁷ India is currently composed of 28 States and seven Union Territories. It has 15 recognised official languages. 216 mother tongues were registered during the 1991 census, of which 22 languages were spoken by more than one million people and 114 by more than 10,000 people. More than 840 dialects are also listed. India has a population consisting of 80,5% Hindus, 13,4% Muslims, 2,3% Christians, 1,9% Sikhs, 0,8% Buddhists, 0,4% Jains and 0,6% of other religions (www.censusindia.net).

to its own security, a perception asserted by several of India's leading political figures¹¹⁸. As numerous ethnic groups are found on both sides of India's international borders, fear for a spill-over effect if separatists seceded in neighbouring countries has been prevalent. India has therefore been exceptionally stern against disruptive and separatist forces. The country's support to governments in the region in solving internal conflicts¹¹⁹ is thus as much for own strategic and preservative purposes (see e.g. Muni 1993). The Central Government in New Delhi has on several occasions interfered in regional politics by dismissing elected state governments and imposing president rule in states assumed to accentuate separatist aspirations or who promote ideologies that have been interpreted as threatening to the unity of India¹²⁰.

I believe these concepts, which accept certain formations but disqualifies other are defining for what I call India's national discourse. Foucault emphasises that notions, statements or practices are constantly under scrutiny and evaluated in accordance with the discursive contents. While certain practices may be accepted, others will be excluded or disqualified. In other words, political formations, people, or others who are seen to represent a threat to the Indian unity will be classified, sanctioned upon and if possible or necessary contained. The destabilising, disruptive and demonic qualities of the LTTE vis-à-vis the Indian state exposed by the assassination, led to their redefinition within this national discourse. They were aligned with various other 'destabilising' political or militant formations, such as the Naxalites or the ULFA¹²¹, which eventually resulted in a "necessary" changed policy. Due to the Sri Lankans' potential affiliation to the LTTE, this also affected them. As demonstrated above, they were

¹¹⁸ For instance India's first Prime Minister Jawaharlal Nehru, and the prominent diplomats Krishna Menon and K.M. Panikkar (Muni 1993).

¹¹⁹ Dispatching troops to Sri Lanka in 1971 during the Marxist JVP insurgency; Military help to the Maldives in 1987 to topple the attempted coup; Arms to the Burmese government against the Karen and Kachin insurgency in 1948-49; Supporting the king and democratic forces in Nepal in 1950-51, helping the police to contain the revolt against the Delhi Agreement in 1951-53; Expressing support for Tibetan autonomy in 1950, 1956-59 (Muni 1993).

¹²⁰ President Rule was imposed in Tamil Nadu in 1976, 1980, 1988 and in January 1991. In 1991 the DMK government was dismissed on the ground of being supportive of the LTTE. It was suggested that LTTE, in conjunction with the United Liberation Front of Assam (ULFA) and the Naxalites represented a serious threat to India's security (Tummala 1992). Article 356 in the Indian Constitution asserts that the President can declare an emergency, dismiss and assume all of the executive powers of a state if there is a breakdown of the constitutional machinery. The executive form is vested in the president, but is exercised on the advice of the Council of Ministers led by the prime minister. The federal form can thus be transformed into a unitary one by the Central Government (Tummala 1992).

¹²¹ United Liberation Front of Assam which aspires to liberate Assam from what is seen as the illegal occupation by India.

monitored, endeavoured controlled and the influx of Sri Lankans into India was sought hampered.

India and the LTTE: Continuities and breaks

Most of the sanctions against the LTTE was initiated, or at least advocated by the government in New Delhi. As I will argue for in the subsequent part on the Indian national discourse, the reactions and sanctions from Tamil Nadu must be seen in relation to the reactions in the capital. Various problematic events during the years prior to the assassination had a major impact on the relationship between India and LTTE, the assassination should not be seen in isolation from these former events, as also stressed in chapter two. The assassination and its severe consequences should be seen in light of a significant set of complex political formations, events and historical factors with varying degree of relevancy at different moments in time. Also the development of various 'ideologies' (for instance the Indian secular and democratic, the Dravidian nationalist and that of the LTTE), their internal dynamics and social factors that were determining for their emergence are important in order to fully comprehend these complex dynamics. Identifying all these factors however goes beyond the project of my dissertation.

I nevertheless find it useful to bring to mind central aspects of the historical relationship between India and the LTTE. The organisation already represented a problem for India in the mid-1980s, but Krishna (1998) argues that the LTTE also was of strategic and political importance for India. Sri Lanka's pro-USA policy was considered provocative during Indira Gandhi's prime ministership, for this reason India saw it necessary to intervene in its affairs. Krishna (1998) and Muni (1993) argue that the support of Sri Lankan Tamil militants with training and arms aimed at bringing Sri Lanka in line with Indian policy and strategic interests. But the Tamil Tigers, contrary to the other Sri Lankan militants never let India control them or intervene directly in their affairs. The unsuccessful IPKF operation, the fighting between Indian forces and LTTE, and India's humiliating withdrawal was a serious blow to India. The relationship between LTTE and India was ruined after this. This was for instance reflected in the establishment of the Special Camps in 1990 and the sacking of Karunanidhi as Chief Minister in Tamil Nadu in January the following year.

After the assassination, the Indian government suspended their direct involvement in Sri Lankan affairs. India is at present quietly observing the development on the island and hope for a peaceful solution. There is a general consensus among the majority of the Indian politicians that a separate Tamil homeland within Sri Lanka's present borders will never be accepted. India has also refused to deproscribe the LTTE as a terrorist organisation, regardless of the ongoing development in the peace-process.

Power at play

This brings us to the aspect of power. What dynamics of power are at work when certain national discursive comprehensions are imposed on others and when notions that are viewed as challenging to the established and 'accepted' are disqualified or invalidated? Furthermore, by what means is a system of sanctions effectuated against such challenging practices? I will argue for a dual and complementary representation of power. In the first, power is executed as intentional acts from and in localised centres. Political actions and performances, such as the arrest of LTTE-people and the implementation of various restrictive policies against Sri Lankans will have its effects by means of such a notion of power. Foucault would label this notion as sovereignty, for instance with reference to kingly rule (Foucault 1980). The second, championed by Michel Foucault is subtle and more structurally inclined. This form of power is not localised, neither to any oppressing individuals or groups, nor to any institutions with the capability to impose its will on others. It is circular and net-like, decentralised and dynamic. It is embodied as it runs through every social relation and is established in every fibre in our bodies. This power discipline individuals and groups and renders certain kinds of actions possible and other less possible or even impossible (Mathiesen 1999). People both undergo and exercise this power. They are its target and its elements of articulation, or in other words, the vehicles of power (Foucault 1980). This notion of power allows us to delineate how certain notions impinge upon people.

Foucault however maintains that the notion of sovereignty has allowed a system of right to be superimposed upon mechanisms of discipline in a way which conceals its procedures. This system is maintained by a process where disciplinary power is exercised through domination, but also by disguising this disciplinary power. The notion of sovereignty is thus important at the level of the legal apparatus (Foucault 1980). Foucault's argument that sovereign power conceals disciplinary formations is important. But on the other hand, it cannot be denied that

certain modes of power are executed and imposed directly on individuals and groups from an oppressive centre. Hence I argue for the existence of two notions of power, which cannot be separated and which must be regarded as mutually complementary. Both operate within the framework of a national discourse. First, the state exercises its coercive and sanctioning power as a result of the changed classification of the LTTE and the Sri Lankans within a national discourse. Then, some people accept and embody this new classification of the Sri Lankans, while others who may disagree will be disciplined due to a fear of sanctions if they challenge or dispute the prevalent discursive validities. The simultaneous exertion of these notions of power is well illustrated in my presentation of the dynamics of surveillance, fear and corruption in the first parts of this chapter. People are victims of suppressive state-governed practices, but they simultaneously discipline their own practices due to fear of an invisible surveillance and possible arrest or extortion.

Execution of institutionalised power

Power as executed from and in localised centres, herein primarily from New Delhi but alternatively also Madras, implies the dominance over mechanisms of control and suppression. The use of this power involves a process of classification, division, control and/or labelling of the Sri Lankans. As I am about to exemplify, this power is generally executed through various institutions or by means of a range of institutionalised practices based in the Indian legal and judicial system. These exertions should be seen in relation to Foucault's notion of power as these regularly reproduce the dominant national discourse, and thus also various disciplining and sometimes repressive formations.

First, the official version of the assassination propagates the LTTE as the sole culprits, though with the exception of a few Indian Tamil nationalists. This version has been given credibility and authority by the Jain commission led by former Chief Justice at Delhi High Court, M.C.Jain. The commission spent seven years investigating the circumstances relating to the assassination and produced an interim report counting 2,000 pages. This view has been enforced by the charging and conviction of the accused, of which five were sentenced to death. The convicted were incarcerated in the high security Special Camp at Vellore Fort. Challenging arguments and versions of the assassination have consequently been rejected on the basis of the findings of the Jain Commission and the trial. By giving credibility to the official version of the assassination, the workings of the Jain Commission and the executive

legal system fix the position of the national discourse, as well as the reproached status of the LTTE that in essence also include the Sri Lankans. This happens albeit that the judicial exercising itself is a product of this discursive formation. The system thus disciplines and reproduces its own dynamics.

Secondly, the comprehensive system of registration with the Foreigners Registration Office where corruption is a frequent problem (as described initially in this chapter) is a mean of monitoring, controlling and also branding the Sri Lankans as deviants. By obliging the Sri Lankans to register regularly with the immigration authorities, they are attributed detrimental qualities which separate them from the normal or accepted. The extensive system of registration was initiated after the assassination which reinforces the transformative quality of the assassination. Tamils of Sri Lankan origin are frequently also only allowed to enter India through Madras. Tamils who were born in Sri Lanka but who live in the West and who occupy a 'western' passport have been refused entry into India though Delhi or Mumbai. These people have often been obliged to buy a new plane ticket.

Thirdly, the employment of the police, Intelligence and Q-branch in tracking down former members or supporters of the LTTE also accentuate the Sri Lankans as a potential dangerous population. The fact that the Q-branch, who originally was in charge of localising and arresting Naxalites now are responsible for identifying and detaining LTTE people also demonstrate the current status of the LTTE in India. The implicit equalisation of the two groups is powerful as the Naxalites are seen to represent a direct threat to one of the central elements in which the Indian Union is based. By means of an armed revolution, they wish to dissolve the current political system and impose a Marxist egalitarian and non-class based system (Ramana 2004).

Fourthly, the Special Camps that were established in 1990 was used to lock up LTTE people classified as "terrorists" (or "deviants"). The extensive security measures and the poor living conditions in the high-security Special Camps (see e.g. PUCL 2000) conveys a powerful signal to the Sri Lankans. The treatment and these harsh conditions which are well-known outside the camps also aspire to avert militants from entering India. As we have seen in the beginning of this chapter, the fear of being arrested and ending up in a Special Camp discipline and

curtail Sri Lankans' actions in Tamil Nadu. Being caught or accused for being sympathetic towards the LTTE may ultimately send them to one of these camps.

Fifthly, the Naval Block introduced in 2000, was a clear message to all Sri Lankan Tamil refugees: they were not welcome in India. The Indian Navy were given permission to open fire at fleeing boatmen who had transported Sri Lankan refugees to the Indian shore in order to stop the influx (The Hindu 2000.05.19). Numerous articles in the press clearly emphasised the position of the Indian authorities towards the Sri Lankan refugees (see e.g. The Hindu 2000.05.19, The Hindu 2000.06.11, Times of India 2000.05.14).

The sixth point brings us to the media which greatly affect people's opinions on the Sri Lankans. This aspect has been approached in chapter five, where I also emphasised media's significance in constructing ideas about the Indian state among the Sri Lankans. While some Tamil papers firmly oppose the LTTE and are highly critical to the influx of Sri Lankans to India, others are considered more supportive¹²². However, among the national newspapers, few articulate positive opinions about the Sri Lankan militants. Kannan, an Indian academic and activist, argued that the media changed its focus on the Sri Lankans after the assassination. He said that "*exaggerated stories were planted in the media*" and that the assassination in many ways created a timeline: before and after the killing. "*Media is spreading false rumours. I am not saying that LTTE are innocent, but media is using LTTE for bringing fear*". He continued: "*Kinship can be broke[n] by bringing in demons. They [the media] manipulate tears and hatred*". A journalist from a major Indian newspaper also stated that there had been a change in Indian media's coverage of the refugee question and the Sri Lankan issue. This change had however come gradually and did not appear from one day to the next after the assassination. He stressed that the violent incidents involving Tamil militants in Tamil Nadu the 1980s, as for instance the shoot-out episodes in Madras (as emphasised in chapter two), largely inaugurated this process.

INDIAN TAMIL DISCURSIVE FORMATIONS

The second level refers to the political formations in Tamil Nadu. The existence of a Dravidian discourse should be emphasised, as this representation promotes a different

¹²² Aadalarasu, a Sri Lankan informant presented his view on the Tamil papers. He said that Thina Malar was against the LTTE, Thina Manni was neutral, while Thina Thandi was supportive.

conception of the Sri Lankan Tamils. The Dravidian non-Brahmin movement (see chapter two) played a significant role for India's approach to the Sri Lankan issue, and represents a formation of relevancy for understanding the Sri Lankans' situation in India. Today's Tamil Nadu¹²³ was one of the first states to express separatist aspirations. This early Dravidian movement emphasised Tamil or Dravidian interests and 'values' vis-à-vis the Central State. They wanted to reclaim "lost" power and privileges from the Brahmins whom they claimed had marginalized the autochthon Tamils on their own soil. Notions of language, literature and "authentic culture" founded on ancient cosmological conceptions were central for this movement, and set in opposition to values attributed to the Brahmins (Aryans), North India in general and the centralised Indian state (Béteille 1997, Subramanian 1999). The Dravidian movement aspired for an independent Tamil nation which included the Upcountry Tamils of Sri Lanka due to their Indian origin, but not Sri Lankan Tamils (Krishna 1998). When the demands for separation were suspended in 1967, Indian Tamils had gradually recognised the idea of being a nation with extensive autonomy within the Indian union. Preserving their cultural uniqueness and maintaining a strong regional self-rule within this union has remained a fundamental issue in Tamil Nadu. I argue that these Dravidian notions of autochthony and cultural authenticity form the basis for this Dravidian discourse and are still ideologically defining for the political formations in the state. Pan-Indian parties, such as the Congress (I) have since the late 1960's been marginalized in Tamil Nadu state elections. The pan-Indian parties are nevertheless dependent on the Dravidian parties to obtain and maintain power in New Delhi¹²⁴. Due to this they frequently also have to make allowances to the Dravidian parties.

From being an issue of little concern, the Sri Lankan issue became highly politicised in Indian Tamil politics from around 1981 (Krishna 1998). From then on, ideas about an ethnic kinship between Tamils from the two countries gained ground in India, and Sri Lankan Tamils started to be looked upon as their "victimised kin". The Sri Lankan militants were hailed as liberators of the suppressed Sri Lankan Tamils, and many Indian Tamil public figures, media organisations and politicians started sympathising with them (Gunaratna 1993, Muni 1993). As earlier stated, Indian Tamil politicians started supporting the militant groups actively with

¹²³ Formerly Madras Presidency.

¹²⁴ From the early 1970s and up to this date, both DMK and the AIADMK cooperated with Central Governments in New Delhi. Congress (I) was for instance able to remain in power due to DMK's support from 1969 to 1971 (Krishna 1998).

money and weapons. But people's and politicians' perceptions of the LTTE started changing long before the assassination. Problems, such as the many gangster-like shooting episodes involving rival Sri Lankan militants in Madras, also with Indian victims, and the combating between the Tigers and IPKF can be noted as important causes. The latter for example led the AIADMK to cease their support of the LTTE in 1987¹²⁵.

Post-Rajiv Gandhi Tamil discourse

The assassination and the consequent redefinition of the LTTE in the Indian national discourse had its effects in Tamil Nadu and Indian Tamil politics. But several aspects should be considered in this context. One is the importance of the Dravidian movement and its discursive formation within the Tamil context. Another aspect is the physical location of the assassination, then the actual effects of the assassination on the Indian Tamil public, but also the disciplining of the Dravidian parties and of their eventual pro-LTTE stances. Inherent in the Indian national discourse is New Delhi's control over the legal system and institutions that can exercise legitimate violence. New Delhi, for instance, has the possibility to impose president rule which *per se* is disciplining.

This does however not imply that there can be a negotiation or a 'meeting' between these discourses, that one discourse can be set up and evaluated against another. This would imply the existence of an essence, or a founding principle for the discourses, and also an identifiable boundary. Foucault argues that there is no such essence. One should look at its outer perimeters and identify processes of inclusion and exclusion of the discourses to detect the mechanisms that are at work (Foucault 1999a). When I argue that notions that are accepted in the Tamil discourse may be disqualified in the Indian national one, this involves a process where various notions (and not any other 'system' or 'logic' such as that of the Tamil discourse) are evaluated in accordance to the respective validities of the national discourse. The various processes and mechanisms at work in the Tamil discourse can thus not be transferred to the national Indian one. For instance, the notion of 'liberators' or 'freedom fighters' applied by certain Indian Tamil nationalists, the LTTE and many Sri Lankans is one such representation. This notion is valid within the worldview or discourse of the LTTE, but

¹²⁵ Some claim that the death of MGR in 1987, who was a strong supporter of the LTTE and the assuming of power by Jayalalitha who was a Brahmin (and thus not a real 'Dravidian') was the main reason for this change in attitude of the AIADMK.

will be disqualified as a deviancy within the national Indian discourse. A discussion between people advocating a national Indian and a Tamil nationalist (or 'Eelamist') discourse, thus on whether the LTTE are liberators or terrorists, will be a discussion founded in two incompatible discourses. Hence, reaching a consensus will be virtually impossible, though the topic may appear mutual at first. Such notions may, with reference to Appadurai (1995), appear as contestations of the state's endeavour to restore equilibrium, when regarding these retributive actions as locality producing events. One must therefore consider each event and notion in the context in which their applications are evaluated.

As I will elaborate on further below, the disciplination of the Dravidian parties was a successful enterprise. Also because the AIADMK already had adopted a tough attitude towards the LTTE after Jayalalitha came to power following MGR's death. But if one looks at the reactions of the local populations and parties in Tamil Nadu, they were maybe not as comprehensive as one would have expected – for example when comparing this with the reactions against Sikhs after Indira Gandhi was killed. Though the AIADMK won a massive victory in the following state elections, there were so to say no violent attacks against Sri Lankans. As we know, the majority of the Dravidian parties continued their silent support of the 'Sri Lankan struggle', though such opinions could be risky vis-à-vis the centre. The Dravidian discourse and the strong devotion to 'Dravidian' or 'Tamil ancient and authentic culture', and the inherent scepticism towards Aryans and north India may have played a vital role in this context. Rajiv Gandhi was from the north (and also a Brahmin) and was to a limited degree seen as someone who defended the aspirations of the Indian Tamils, central notions that were entrenched in the Dravidian discourse.

There is another factor of importance: The fact that the assassination was committed on Indian Tamil soil was of great significance. This was clearly emphasised by Kannan in the opening quotation of this chapter, when he describes the Indian perception of the event: "*If Rajiv Gandhi would have been killed in Andhra Pradesh, no problem, but not in our house*". Appadurai's (1995) phenomenological approach about human activities that have specific material effects and produce locality is consistent with Kannan's argument. Implicit in his statement is that the assassination was interpreted as a violation of their "house" or of the soil of the Indian Tamils. I don't believe the house-metaphor is incidental. Hospitality is considered a highly

virtuous and noble act among Tamils¹²⁶. The Sri Lankan Tamils violated the hospitality shown to them by committing this act and broke the trust of their hosts.

The changing opinion of the local Indian population

Many people and politicians who previously hailed the LTTE undoubtedly turned against the Sri Lankans after the assassination. It was virtually regarded a crime to be sympathetic to them, and ‘once having supported the LTTE’, became equal to ‘once having supported the terrorists’, and not ‘once having supported the former liberators cum terrorists’ – which from an Indian (primarily Indian Tamil) perspective may have been more accurate. The former imagery of the heroic liberators became illegitimate, and only the new perception of the LTTE as terrorists was given legality. This disciplining can be reflected in LTTE sympathisers’ sudden silence in fear of sanctioning.

Mahesan’s story below illustrates how many Indians now were negating former pro-LTTE opinions. Mahesan was a Sri Lankan with strong sympathies for the LTTE, who also had ties with Indian Tamil nationalists and LTTE-supporters. He was arrested with a companion after the assassination following a series of dramatic events, but was later released. He told me that many officials and police officers had to downplay and silence their support of the ‘Tamil cause’ after the assassination in fear of punitive measures.

On the day that he and his friend were arrested, a prominent official scolded them and said that he and his friend had helped the LTTE. He claimed that his friend was an LTTE-supporter. Mahesan’s friend responded by saying: “*You also gave one month salary to LTTE during MGR*¹²⁷”. Mahesan said that this reminder silenced the official: “*He kept quiet*”, he said. Mahesan said that this prominent official used to support the LTTE, but had to change his political views after the assassination: “*‘Raju’ (The official) had to adjust to new Governments. Politically he can not be sincere*”, he said.

Mahesan asserted that many Indians, including officials and public figures supported the LTTE before the assassination. These people could not continue their support after the assassination in fear of sanctions. Based on discussions with both Indian and Sri Lankan informants, it appeared that some ceased their support of the LTTE because of the killing which they condemned, while others continued, but kept a lower profile.

¹²⁶ Verse 86 in the Holy Kural states the following: “Who hosts the passing guests and waits for more; Will be hosted by the Gods” (Thiruvalluvar 1990:27)

¹²⁷ ‘MGR’ was known to be supportive of the LTTE and helped them economically on several occasions.

Indian Tamil politics on the Sri Lankan issue

The Sri Lankan issue is still a hot potato in Tamil Nadu politics. In spite of the Centre and AIADMK's resolute attitude on the Sri Lankans issue, many Dravidian parties have sustained a silent support of the Sri Lankan militants. Such attitudes were however well concealed during the first years after the assassination. DMK's allies in power during my fieldwork, the MDMK and the PMK, are known to be among the more passionate Indian political LTTE-supporters. They were far more outspoken than the Chief Minister and the DMK, who have subdued their support the last few years, but who among many still are considered sympathetic to the Tigers. Due to this, AIADMK and its leader Jayalalitha, sought for the banishment of these parties from the National Democratic Alliance (NDA)¹²⁸ – the Central Government coalition. Jayalalitha's stance towards pro-LTTE parties and fractions has been fervent. In 1992, Jayalalitha wrote a letter to the then Prime Minister, P. V. Narasimha Rao, demanding the Central Government to ban the PMK due its support for the Sri Lankan militants. In June 2000, another incident caused political turbulence in Tamil Nadu. Coinciding with Karunanidhi's 77th birthday, the DMK-supremo proposed an alternative 'Czechoslovakian solution' to the Sri Lankan crisis if Tamils were not to enjoy equal rights on the island. He likened this process to the separation of a man "from an unwilling wife" (Viswanathan 2000). This alternative solution was sensationalised by the opposition and presented as proof of the Chief Minister's support of the LTTE. This incident was caricatured in a cartoon in 'The Hindu', as seen below.

The Sri Lankan question with LTTE as its principal character is highly politicised, but political opinions on this issue have tended to have a populist leaning. Gaining and maintaining political power has on several occasions appeared to be more important than representing and expressing a clear political stance on this issue. PMK was, for instance, a member of the NDA and the Tamil Nadu State Government coalition, together with the DMK and the MDMK, until they broke away in February 2001 due to internal disputes in the coalition. As in 1998, when Jayalalitha went into an electoral understanding with PMK, they once again engaged in a coalition following this break. Jayalalitha's ardent criticism of the PMK for its pro-LTTE stands (see e.g. The Hindu 2001.02.07) ceased when their coalition

¹²⁸ The NDA remained in power until 2004, when it was replaced by the Congress (I) led coalition.

was formed. She is quoted as saying: “As far as I am aware, the PMK is demanding a separate Eelam, not a separate Tamil Nadu” (The Hindu 2001.02.12).

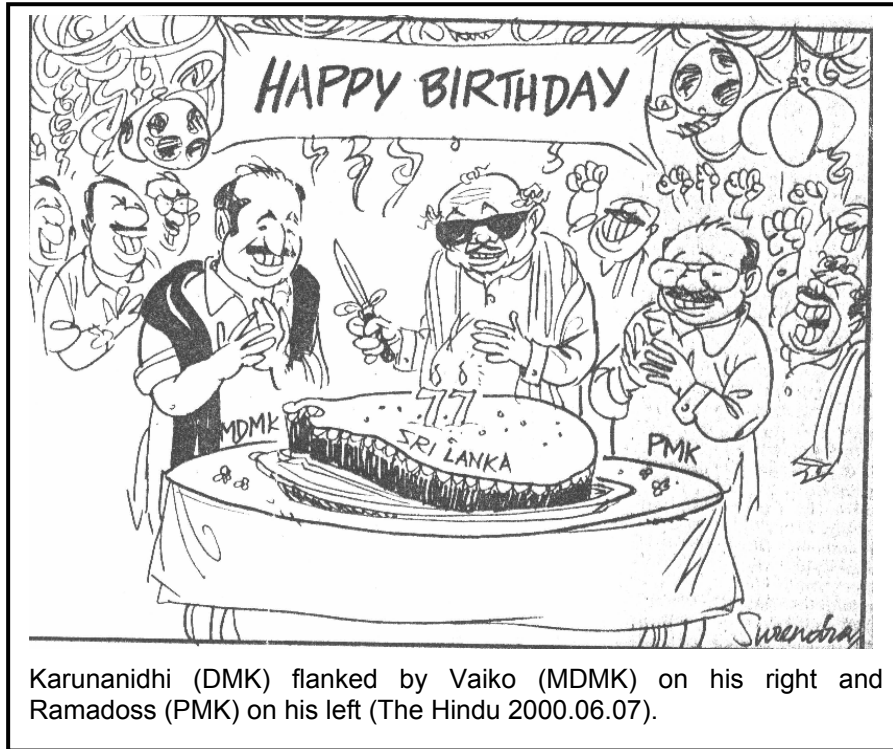

Karunanidhi (DMK) flanked by Vaiko (MDMK) on his right and Ramadoss (PMK) on his left (The Hindu 2000.06.07).

MDMK and the PMK have been supported by, and have shared certain ideological inclinations with various other Indian Tamil nationalist factions such as the *Tamil Nadu Liberation Front (TNLF)*, *Tamil Nadu Liberation Army (TNLA)* and the *Tamil Nadu Retrieval*

Troops (TNRT), all radical and militant in their dispositions. These parties and alliances have been commoved by, and often have drawn attention to the LTTE in their political rhetoric. Prabhakaran has frequently been accentuated as a pan-Tamil leader who unites the exploited Tamils against alien intruders, whether they may be Sinhalese or Aryans (Brahmins) from Northern India. The parties and alliances regard the “heroic struggle” for Tamil Eelam as a model and inspiration for Tamils world-over (Cheran 2001). Eventually, Vaiko, the leader of MDMK and Maran, the leader of TNLF, was jailed under India’s new anti-terrorist law (POTA¹²⁹) for speaking in favour of the LTTE during a public political meeting in July 2002 (The Hindu 2002.07.12). TNLA and TNRT were banned on an earlier stage under the same law (The Hindu 2002.07.03). The sanctions that may emerge from expressing such stances publicly has had disciplining effects and have prevented such notions from surfacing more often.

¹²⁹ Prevention of Terrorism Act 2002, Act No.15 2002.

THE SRI LANKAN TAMIL POSITION

The third level is that of the Sri Lankans. The fact that India armed and trained the militants and also accepted thousands of refugees from Sri Lanka generated the conception among Sri Lankans that India and Indian Tamils were supporting them. People who came before 1991 also said that they were well-received by the local population. But at the time of my fieldwork, and as presented in chapter five, few Sri Lankans expressed positive feelings about living in India. The killing was presented as the event that fundamentally changed their situation. Many Sri Lankans expressed, almost in dichotomous terms the differences between 'before' and 'after' the assassination.

These changes were presented by identifying tangible changes such as the government's political actions, the emergence of surveillance and corruption and various problems with by the local Indian population. But this understanding often appeared to be more of an established conception among the Sri Lankans, than a notion based on experience. Many people who had not yet arrived in India in 1991 for instance stated that the situation of the Sri Lankans in India was better before the assassination. When it came to explaining the strained relationship to local Indians, the assassination was presented as one of many reasons for this decline. As we saw in chapter five, this relationship was more about local dynamics than about structural power politics – though this of course also was an aspect of relevance. However, this totalising understanding of the assassination underlines how the Sri Lankans construct an understanding of themselves in their location, and how this narrative was employed to resist state oppression. Bruner characterises narratives as a sort of storytelling that should be regarded as social constructions. They are fashioned by selected experiences which create structure and meaning for individuals or social entities, and do not necessarily reflect actual events (Bruner 1986). Meaning is thus not created by the event itself, but by the position that it has obtained in a discourse¹³⁰. Bruner stresses that narratives are connected in a linear sequence which place events within a framework containing a past, a present and a future. These parts should thus be understood in relation to each other. Kannan, the Indian academic and activist presented before, described the assassination as a 'year zero' for the Sri Lankans in India.

¹³⁰ Discourse in Bruner's context is different from that of Foucault. He argues for the existence of three key elements in a narrative: Story, discourse and telling. Story is the systematically related abstract sequence of events, or the syntagmatic structure. The discourse on the other hand relate to the manifestation of the story, its mediation in a specific medium, such as a novel myth lecture etc. The telling is the action, the act of telling (Bruner 1986:141).

Sri Lankan interpretation of the assassination

The redefinition of the Sri Lankans to a community of potential terrorists implied a change in their status as local subjects from an Indian point of view. As I have noted earlier in this chapter, the assassination became an appendix with which the Sri Lankans were to be associated. The Sri Lankans however observed another kind of transformation, a rather opposite one compared to the dominant Indian. In their eyes, they were not the ones who underwent transformation; it was the Indian state and community. And what's more, changes occurred on all levels of Indian society: on national, state and local level – in their neighbourhoods and surroundings. This again affected and consequently restricted their behaviour. For instance the fear described in the first parts of this chapter was seen as a consequence of the structural changes that emerged after the assassination.

Of course, changes occurred both in an Indian and Sri Lankan context or discourse – if you will, in the way they interpreted the assassination and reacted to it. And both Indians (speaking of both state and local level) and Sri Lankans would agree that their attitude towards the other had changed. But the focus should be set on the different interpretations of the assassination. While Indians, principally on state level would see their own changed attitudes or actions as necessary responses to Sri Lankan terrorism, Sri Lankans would see their changes more as a reaction and adjustment to Indian state oppression or to the state's redefinition of them. Both comprehensions would imply an identification of themselves as victims, either of the assassination or of its consequences, as well as a dissociation of themselves with the event. The Sri Lankans' basis for understanding the assassination was not based on the Indian national discourse, and they would naturally not understand themselves to be a potential threat to India. Their framework for approaching the assassination was fundamentally different. A crucial factor in this context is power, which eventually leaves the Indian state with the 'upper hand'. The Indian national representation is distinctive due to its inherent authority, sovereign status and control over disciplining institutions – such as the intelligence, prison, the legal system etcetera. Though many events and incidents already had contributed to the deterioration of the status of the Sri Lankans in India, the assassination was largely perceived as the defining reason for this change. The consequences were so totalising with the Indian state's change in policy and their extensive use of power. The Sri Lankans' consequent general change of behaviour, such as the fear initially described, also emerged from the disciplining formations that surfaced after 1991. Because the assassination

came to represent such a totalising transformation, it also became the event in which the Sri Lankans used to react or resist against the perceived unjust treatment of the Indian state.

Pre-assassination

As already stated, the narrative representation of the assassination frequently accentuated a difference between 'before' and 'after' the assassination. The sympathy many Sri Lankans claimed existed in Tamil Nadu before the assassination was regularly exemplified by various stories and experiences. Muthalingam, who had lived in the state since the early 1980s, presented one such incident that occurred some years before the death of Rajiv Gandhi:

Muthalingam had been out driving in the city one day. Absorbed in his own thoughts he passed on a red light and was stopped by a policeman. The police officer told him that he had "*committed a very serious crime*", for which Muthalingam apologised. The policeman explained that he could end up in prison for his crime, and asked him if he wanted this to happen. Muthalingam had replied, "*No, but what can I do?*" He said to me that he assumed the policeman was after money, as ending up in prison for driving into the red was not regular procedure. The policeman asked Muthalingam his occupation, and he replied, "*Nothing*". The officer asked, "*Nothing?*" "*Yes, I am a refugee*", he replied. The policeman said, "*Oh, you are a refugee!*" The policeman told Muthalingam to wait, and ran over to the nearest tea stall and bought him a cup of tea. Muthalingam told me humorously that he was released without a fine.

This story does not only portray the sympathy that existed among many Indians for the Sri Lankans, but it also reveals the existence of dynamics of corruption. In this story, Muthalingam was left unaffected due to the sympathy of the police officer. Such compassion was according to him rather frequent in the early 1980s, but generally decreased by the end of the decade.

The assassination

The assassination was spoken much of, and common for many Sri Lankans who had been in India in 1991 was their disbelief when they learned that LTTE had committed the act. They never thought LTTE would go to that step. Many recalled a fear for being attacked by mobs like Sikhs had been in 1984 after Indira Gandhi was assassinated by her Sikh bodyguards after 'Operation Blue Star'¹³¹. In spite of the Sri Lankans' fear, violent reprisals against Sri Lankans were so to say non-existent in Tamil Nadu (Bastiampillai 1996, Suryanarayan and Sudarsen

¹³¹ 'Operation Blue Star' was an assault by the Indian army on the Golden Temple, the holiest Sikh shrine in Amritsar, where Sikh separatists were entrenched with arms. As a result of this assassination, more than 5,000 Sikhs were attacked and killed by furious mobs. The police did little to interfere.

2000). Most Sri Lankans saw it as beneficial to keep a low profile, to attract as little attention as possible. However, in the frenzy that followed when LTTE's involvement was revealed, Sri Lankans were arrested, checked and interrogated in masses, and many recalled the fear for what detention would imply.

Garnet was in India in 1991 where he had been living more or less continuously since 1984. He fled to India from his natal place in the Sri Lankan Hill Country after getting into trouble with the authorities for organising a trade union for the Upcountry Tamils. He used to support the LTTE around the time of the assassination, but said that he did not like what the organisation eventually turned into. In 1991, when Garnet learned about the killing, but before the connexion was made between the assassin and LTTE, he was convinced that the Tigers were innocent: "*There was good talking between Rajiv Gandhi and LTTE at the time*", he told me. He stayed in a hotel on the eve of Rajiv Gandhi's death. When news about the assassination was announced, the hotel receptionist said to him that he believed the LTTE was responsible. Garnet said he was convinced that it wasn't the LTTE, "*...because there where no reason for it*". He said he was shocked when learned about LTTE's involvement.

Garnet said he used to spend a lot of time with one of his Indian friends, Chandran around the time of the assassination. Chandran always had a lot of people visiting, many with strong political opinions. He said "*I needed a lot of guts to be in Chandran's place. There were many Rajiv Gandhi supporters there*". He recalled an episode at Chandran's house, where he was discussing the assassination with some Indians. As he still supported the LTTE, he defended the assassination. The discussion grew ireful to the point where one Indian had yelled at Garnet: "*You killed my leader!*". Garnet told me that the Indian had trembled with rage and had his eyes wet with tears, but he was too small to beat him up. Garnet said that people often wanted to give him a beating, but he was usually protected by Chandran. He said to me "*I had problems because I was a Sri Lankan, if I would have been an Indian I would still have problems, but in a different way*".

Some of my Sri Lankan informants, such as Ramaswamy were in India during the assassination and were detained by the authorities.

Originally from Colombo, he fled the island after the riots in 1983. I asked him about his experiences when Rajiv Gandhi was killed. He said "*Everybody outside the camp had to report to the police within one week. They gave you a form. You had to write what reason you came, what you do here, how you came here, who pays your expenses*". He said "*I did not have an Indian visa at the time, but I had a valid passport. I could have been taken into custody*". He said that he was lucky to know the police officer who interrogated him. The policeman had helped him after the car accident where his wife was killed. "*He didn't make any problems to me*" he said, but believed that he would have got into trouble if some other police officer had interrogated him. "*People were arrested like animals and put in custody. I have to thank God that 'Mr.Subramaniam' (the police officer) was there. So many Sri Lankans [were] arrested*".

The conception that things were changing was soon reflected in the new political climate and the actions taken by the Central and State Government. The victory of AIADMK in the State elections in Tamil Nadu was an early sign of this emerging transformation. DMK, who were considered supportive of the LTTE, lost all the seats they contested. Muthalingam described the immediate aftermath as such: “Jayalalitha¹³² swept the elections in 1991. There was an emotional upheaval in Tamil Nadu [after the assassination]. Anything related to the Sri Lankans became politicised. Sri Lankans were portrayed as dangerous”. Jayalalitha and her party AIADMK had adopted a clear anti-LTTE political position since the outbreak of fighting between the LTTE and IPKF in the late 1980s. Muthalingam emphasised that the authorities did not know what to do with the Sri Lankans after the killing. They were unable to separate the people who had connexions with the LTTE from those who had not.

Immediately after the assassination, the State Government ordered all Sri Lankans to register personal details at the closest police station. Within 14 days of the notice, and after having extended the dead line, only 25,000 of approximately 100,000 Sri Lankans had registered (The Hindu 1991.07.15). A week later the police had arrested and taken 1,500 unregistered Sri Lankans in for interrogation, and detained them in special camps “exclusively meant for them” (The Hindu 1991.07.23). According to The Refugee Council (1999), a total of 2,060 identified LTTE-people were arrested and detained in special detention high-security camps in 1991. As Ramaswamy described above, there was frenzy, and Sri Lankans were arrested randomly by the police in order to detect LTTE people and supporters.

LOCAL APPROACHES ON THE ASSASSINATION

As explained above, the majority of the Sri Lankans shared the perception that the Indian state and public changed after the assassination. This created a common sentiment of fear and mistrust which shaped their behaviour. Furthermore, the narrative conception presented an almost totalising difference between 'before' and 'after' the assassination, both with respect to people's attitudes and to Indian political conductance. Hence, the assassination and then the Indian responses were comprehended as the reason for their miseries. When various inconsistencies concerning the assassination emanated this could be used to question the legitimacy of the actions affecting them.

¹³² She was the Chief Minister Candidate for AIADMK, and was intensely anti-LTTE.

The official version of what happened that fatal day in Sriperumbudur was questioned by informants of both Sri Lankan and Indian nationality. Numerous theories about the assassination surfaced. These alternative versions were sometimes supported in books, articles or in testimonies quoted in various national newspapers. Numerous books have been published on the topic with different theories on who the ‘real’ culprits were and what ‘really’ happened. Incidents such as the mystical suicide of one key witness, Shanmugham¹³³ ; why the police waited so long to apprehend Sivarasa in Bangalore¹³⁴; and what motives LTTE had for assassinating Rajiv Gandhi in the first place, were just some of the questions that were raised. The assassination eventually assumed an almost mythical dimensionality surrounded by great mysticism and speculations, similar to the assassinations of John F. Kennedy and Olof Palme. Several people who were interrogated by the Jain commission had theories and stories that diverged from the official one. But as stated in Ramesh Dalal’s (2001) book on the assassination, few were considered by the commission and included in the final report.

Most Indians I spoke to believed that the LTTE had executed the suicide operation single-handedly, though some also expressed uncertainty on the issue. However, countless theories circulated among the Sri Lankans about who the “real perpetrators” were. Some believed that the LTTE were the only ones involved, others said that USA and CIA masterminded the whole plot with or without the participation of the LTTE (see e.g. Dalal 2001). Some theories claimed that the LTTE itself was not involved at all, but that some ex-LTTE people did it for large sums of money. Others again claimed that the Sri Lankan government was behind it,

¹³³ Shanmugham, a smuggler and LTTE sympathiser was a person with whom Sivarasan and Dhanu had stayed after coming to India. He voluntarily surrendered to the police, and his testimonies revealed important facts and circumstances relating to the assassination. 121 cases of explosives, wireless sets and 3,200 litres of petrol were seized based on his revelations. According to Dalal (2001), his testimonies were expected to lead to the arrest of several influential Indians. However, a few days after he surrendered, it was reported that he had run away from custody during the night. He was later found hanged in a tree; the conclusion was that he had committed suicide. It was questioned why a person who had surrendered to the police suddenly would run away and commit suicide. Also, he had used a heavy 12 feet rope which usually would have been impossible to obtain in the middle of the night. The use of two knots instead of one raised further questions about the truthfulness of Shanmugham’s suicide. Several normal physical and bodily effects occurring when someone jumps from a tree were also missing.

¹³⁴ In August 1991, Indian police obtained information about the hideout of people believed to have been involved in the assassination in a house in Bangalore. Among them were Sivarasan, who was believed to have masterminded the operation. According to Dalal (2001), once they found Sivarasan and his accomplices’ hiding place, the Bangalore police were told to wait for the leader of the Special Investigation Team (SIT) before raiding the house. It took two days before the SIT team arrived. Even then, the operation was delayed a long time because more Central Reserve Police Forces (CRPF) had to be summoned. Eventually thousands of police force personnel were there to catch four people, and on the morning the 20th August some 120 CRPF men went in. This long delay did give Sivarasan and his two accomplices inside the house not only enough time to burn and destroy all records and material which could have been vital in upcoming investigations and trials, but also to commit suicide by consuming cyanide.

while some said that RAW¹³⁵ and some anti-Gandhi members of the Indian Congress Party were responsible. There were also reports that Yasser Arafat had warned Rajiv Gandhi about threats to his life (see e.g. Dalal 2001, Express India 1997.11.22). As an example, Ramaswamy said that LTTE did not have any motives for assassinating Rajiv Gandhi. He could not understand why they had done it:

“If LTTE was involved, there was definitely a conspiracy behind it. My personal opinion is that some LTTE-members will do anything for money. I don’t think Prabhakaran knew about this. India would turn against him. ... Rajiv Gandhi was going to Iraq to see Saddam Hussein, and US was attacking. Rajiv Gandhi was against the US”.

The way people viewed the assassination seemed to be closely related to their political opinion on the LTTE. Most people held that the assassination was a malevolent act, and most Sri Lankans that I spoke to had nothing against Rajiv Gandhi. They, however, did not like his enactment of the IPKF but believed he had been misguided by others.

The majority of the Sri Lankans supported the Tigers in one way or the other. But as already stated they generally found it either hard to believe, and some did even not trust that the Tigers were behind the assassination. They saw no reason or any possible benefit, neither political nor military for the LTTE from killing Rajiv Gandhi. Among the Sri Lankans who were critical of the LTTE, basically all believed that they were responsible for the killing, and moreover, they believed that the LTTE had done it single-handedly. These people considered the LTTE to be a fascist organisation prepared to get rid of anybody standing in their way of achieving their goal of Tamil Eelam, but nonetheless an organisation with the dignity not to do somebody else’s job. Many of these people also thought it strange that LTTE should kill Rajiv Gandhi, as they did not see any benefits from the action.

Several Sri Lankans had objections against the LTTE, or feared them, but stated that the LTTE were the only ones who really fought for the Tamils in Sri Lanka. I asked several people their opinions on the LTTE, and the attitude among the majority of my informants was indeed ambiguous. One man responded: *“I do not accept all they say or do, but there is no other alternative. They are in the field to liberate the country. Shooting and killing is bad to the community, yet we are forced to the position to support them”*. Another said: *“I also like Prabhakaran. I hate him, but like*

¹³⁵ ‘Research & Analysis Wing’, the Indian foreign intelligence agency.

him also, or admire him [...] He is a strong leader". A frequent attitude was that people liked the LTTE, but not their methods. Differently from the LTTE, the Tamil political parties and the other militants were often describes as corrupt and unreliable. Murugan, the former LTTE-cadre, expressed this attitude, though stronger than most others.

"LTTE don't fight for food or money, only for Tamil Eelam. LTTE have no bad habits, no smoking or drinking ... Other militant groups are cheating and looting the people. Their aim is to get money. How have they become very wealthy, living well? They have bad habits – drinking, smoking, joining with the government. Other groups kill civilians, and say it is LTTE. If we get Tamil Eelam, these people cannot go to Tamil Eelam. They would be killed. They are traitors".

Most people had difficulties in expressing a clear stance towards the LTTE, and consequently on the assassination. On some occasions, they expressed admiration of the LTTE due to their diehard and nonnegotiable determination for the "Tamil cause". But in other situations, they expressed a clear disapproval of them due to their brutality and lack of flexibility. These changing attitudes usually coincided with changing approaches to the assassination. When people blamed LTTE for having killed Rajiv Gandhi, they usually also expressed disapproval of them. However, when they expressed doubt about LTTE's involvement, they frequently also articulated an admiration.

The Sri Lankans' perception and interpretation of what 'really' happened on that fatal day in May in Sriperumbudur relate to the assassination as an historical event. But I believe the profound amplitude of the assassination had a major impact for their historical interpretation and approach to the event. As its consequences appeared so all-embracing, these simultaneously appeared to emerge independently of other former disturbing and deteriorating events. A crucial question is whether such above-mentioned alternative interpretations on the assassination can be interpreted as a sort of resistance. I will argue that it can. I believe the Sri Lankans' approaches largely can be seen as counter-hegemonic, as they first highlight the assassination as the reason for their miseries, and then question the official version of it. Jenkins maintains that the process where one is authoritatively labelled within an institutional setting may involve a process of internalisation by those labelled, which again may evoke resistance (Jenkins 1996:22-23). Protest is thus conducted on the premises of the dominant hegemonic discourse, which in effect represents a contestation of the Indian state's reasons for conducting its suppressing policy. As stated above, people also seemed to adapt their interpretations of the assassination to their own views on the conflict

and the LTTE. However, no matter how the Sri Lankans interpreted LTTE's possible role in the assassination, the Sri Lankans would turn out to be the victims. By negating LTTE's involvement, they question the political measures that were executed by the Indian government, which they perceived as unrighteous. And by accepting the LTTE as the culprits, the Tigers were indirectly held responsible for the Sri Lankans' miseries. Both these versions represent dissociation with the assassination, and put the blame for their troubles on others.

EPITOMISING THE POST-RAJIV GANDHI SITUATION

Hence, the Sri Lankans status was transformed from the "victimised kin" via the intermediate state following the assassination of Rajiv Gandhi to a "community of potential terrorists". However, after some years, the status of the Sri Lankan community gradually and relatively stabilised. In spite of the reversal of several political measures which affected the Sri Lankans in a negative way, they are still looked upon with scepticism and mistrust, and as we have seen, they are regularly victims of repressive measures. The Indian compassion which existed before the assassination did not disappear altogether, but was severely weakened. The Sri Lankans are still mistrusted by both Indian public and authorities, but the initial rage and emotional upheaval have if not vanished altogether, at least diminished.

In the first part of this chapter, I gave a presentation of the tangible political consequences of the assassination, followed by a set of implications for the Sri Lankans. These implications dealt with the emergence of repressive formations such as surveillance, corruption and extortion. I have argued that these formations have led to a general sense of fear and suspicion among the majority of the Sri Lankans, which had a disciplining effect on their behaviour. The second part dealt with the assassination itself, as an event with a strong transformative potentiality. My approach to the assassination has been multifaceted. I have used various theories to grasp the phenomenological dimension and the processual transformative side of this event, and I have presented an approach that addresses its enduring effects. Power is the principal aspect of the third and last part. In order to identify the reasons for the wide-reaching effects of the assassination, I have used Foucault's discourse theory. I have argued for the existence of a national Indian discourse, in which the LTTE especially, and the Sri Lankans generally were transformed into a category considered to be a threat to the Indian state. By means of various mechanisms, both institutionalised

and/or disciplining, conceptions that were regarded supportive of the LTTE (thus threatening to India) were sanctioned upon and reacted against. These sanctioning dynamics influenced both Indian Tamils, where the support of the LTTE still occasionally exist, as well as the Sri Lankans in their daily life. Due to the severe political measures affecting them, the Sri Lankans often conceive the assassination as the source of their miseries. By questioning the dominant discursive comprehension on the assassination, they simultaneously contest the unreasonable measures of which they have been subjects.

It is evident that the assassination had a significant impact on the Sri Lankans' situation in India. Though local dynamics appeared to be of greater significance for people's conceptions of their situation in India, the effects of the assassination permeated the Sri Lankans' daily behaviour, and transformed their general situatedness in India. Their situation in India should be addressed with the assassination's various effects in mind: first its transformative dimension which led to their redefinition into a conceived community of potential terrorists; then the ensuing repressive formations, manifested by surveillance, recurrent corruption and extortion, and emerging disciplining fear; and finally the emerging social reclusion and the strained local relationship between Indians and Sri Lankans.

The discursive reinterpretation of the Sri Lankans to a conceived community of potential terrorists became embodied in terms of affecting their status and disciplining their behaviour vis-à-vis the Indian host population. This must be seen in relation to the processes described in chapter five, where the Sri Lankans are ascribed specific primordial qualities, and where their knowledge and worldviews regularly are invalidated or subjugated to those of the Indians. Though Alfred Schutz (1970) argues that processes of ascribing others specific qualities and disregarding their worldviews necessarily exist between all groups, the demonisation of the Sri Lankans represented an important dimension in this respect. The demonisation relegated the Sri Lankans' knowledge and conceptions and placed the Indian population in a position of superiority and dominance. The disregard of the Sri Lankans' worldviews is apparent in a discursive context. As we have seen in this chapter, the reason for the demonisation of the Sri Lankans was their potential link to the LTTE, due to their shared nationality, who were deemed responsible for the assassination of Rajiv Gandhi, and thus seen as an entity which threatened the unity and democratic principles of India. In order for them to challenge the repressive measure of which they were victims, they also had to

challenge the reason for their transformation, the assassination of Rajiv Gandhi. In other words, protests had to be conducted within the framework of the dominant discourse, where entities that were seen as a threat to the unity and democratic principles of India were sanctioned upon. In this sense, worldviews that contested this logic were not only ignored, but they were invalidated and considered as heresies within a dominant discursive logic. The negotiation of practices and identities between the Indians and Sri Lankans thus involved an important dimension of inequality.

With the discursive formations in mind, which to a large degree disciplined the comportment of people in Raja Nagar, the relationship between the host and exile population should be understood in terms of local formation. Local identity formations among people in Raja Nagar were following Fredrik Barth (1969) and Richard Jenkins (1996) the result of preconceptions negotiated at the boundaries between groups. On the other hand, certain perceived and experienced cultural differences, as well as historical and societal differences should also be considered. Nevertheless, the negations of identities were the result of perceived differences, whether preconceived or based in more tangible historical and cultural formations, which stresses the fruitfulness of a phenomenological approach, as for instance accentuated by Alfred Schutz (1970). How people conceive their own situations, their fellowmen to use Schutz's own concept, and their environment were defining for how they eventually construed their situation and constructed their identities. This also incorporates the disciplining dimension. When the environment is conceived as insecure, this will also structure people's behaviour and actions. As presented in chapter five, former disruptive events in Sri Lanka could lead to a greater awareness towards their environment. In similar ways, troubling experiences in India with the local populations frequently shaped their perceptions of their Tamil counterparts. In this context, other people's experiences and stories were often equally important in constructing images of the other.

However, the actual impact of the transformation of the Sri Lankans varied. As we saw in chapter five and in this, people from Jaffna or people who had physical marks on the body, such as bullet wounds, which made them likely suspects of militancy were frequently more reclusive than others. These people knew they were vulnerable to repressive dynamics and thus disciplined their actions to a larger degree than others. We saw for instance that people refused to talk about issues related to the conflict, and especially to the LTTE, and for

example that Murugan refrained from doing martial arts. Moreover, some people from Colombo were even unaware of the problems that some of their countrymen had with the authorities. In this context an extensive diversity, internal categorisations and stereotyping existed within the Sri Lankan community. These differences were usually rooted in geographical origin and caste differences, but conflicts also emerged between people of different generations. Friction or negative preconceptions between people of different origin and caste were frequently believed to be rooted in primordial differences and usually dealt with political formations and experiences back in Sri Lanka. Friction within families along generational lines usually related to views on India and marriage.

The aspect of trans-nationality has also proven to be very important for the Indo-Lankan relationships as they are structures and negotiated in Raja Nagar. Sri Lankans with such trans-national family networks were primarily of Jaffna origin, and often received remittances from relatives living in the West, and were often fairly wealthy. Such affluence was often displayed by excessive spending or by the construction of large houses and the purchasing of expensive cars. Their money was seldom invested in the local economy, principally due to the perceived temporality of their stay in India. Hence, this trans-national economy commonly contributed to the strained relationship between the Sri Lankans and Indian population. Due to these habits, Sri Lankans were often liable to jealousy from the Indian population. But it also increased already existing differences within the Sri Lankan community, between people who could afford sending to or financing relatives in a Western country and those who lived on own income in India. This economy should also be seen in relation to the consequences of the assassination of Rajiv Gandhi. As Sri Lankans had become more liable to corruption and extortion resulting from their demonisation, remittances from abroad could often increase this problem. People from Jaffna in this sense possessed a double burden making them particularly prone to repressive dynamics. They were not only suspected of militancy due to their origin, but as they often had relatives abroad who remitted money to them, they were more attractive for extortion.

Also, their reclusiveness was apparent in Raja Nagar, compared to Sri Lankans from other parts of the island. An additional dimension of these trans-national family networks was that they produced ideas about other possible lives, as contended by Arjun Appadurai (1991). Many displayed great material wealth or 'Westernised' modes of behaviour and dressing. Such

exhibition was received with mixed feelings by Indians and Sri Lankans in Raja Nagar. Younger people were generally more attracted to Western values and were eager to go to the West, while people of rural origin and from the elder generations were frequently more skeptical to 'Westernised' values displayed by these Sri Lankans living overseas. However, seen in a broader family context, having relatives in the West was a means to subsist in a country towards which they felt an aversion and where Sri Lankans were deprived of the better-paid government jobs. As was demonstrated in chapter seven, such journeys could however involve great risks, especially if they were arranged through so-called illegal agents, which was fairly common. We saw from Devani's journey to Canada, that arranging a journey abroad could be very complicated when it was done legally. It could be very costly and take a very long time to organise due to the recurrent bureaucratic muddle and corruption involved. As argued in chapter five, the bureaucracy is a domain comprising the context within which the Indian state is imagined, experienced and construed for the Sri Lankans. It is here and in the media that the power inherent in the dominant discourse is conceived and consolidated for the Sri Lankan community. The corruption commonly encountered in Indian public institutions, together with the restrictions introduced by the Tamil Nadu state government and New Delhi's support to the Sri Lankan government fight against the LTTE, produce the conception of the Indian state as hostile.

In order to understand the Sri Lankans' situation in India it is, thus, crucial to identify their processes of identity construction and negotiation in relation to the India host population. Significant aspects, influencing these negotiations are trans-national family networks as well as their attributed redefinition, following the assassination of Rajiv Gandhi. These processes must be understood historically as well as multi-locally, and I thus re-emphasise the necessity of a spatio-temporal approach to this community that has been undertaken in this dissertation in order to bring to the fore the full importance of these broader dimensions. As has been demonstrated above, politico-historical processes, nationalist sentiments and political agendas have been defining for how the Sri Lankans eventually are situated in India. It should also be evident from this chapter that this multilocality not only relates to the different domains which affect or are influenced by the Sri Lankans in India. India should in similar ways be regarded as such. The approaches to the Sri Lankan issue and the Sri Lankans in India are highly multifaceted. DMK and other Dravidian parties have stressed their sympathies for the LTTE. These parties are largely at odds with the approach of the central

government, but have been forced to subdue such sentiments in order to evade sanctioning. In a similar way, the local bureaucracy and the local Indian population display other characteristics. Due to the Sri Lankans' recurrent fear, corrupt bureaucrats are aware that many Sri Lankans are easy targets for extortion, which many exploit. The Indian local population, on their side, largely base their comprehension of the Sri Lankans on local practices and events which in various ways have influenced their lives. The strained fraternity between the Indian and Sri Lankan Tamils must be considered in light of identity formations, migration and the social transformation of which they have been subjects.

The situation of the Sri Lankans in India is currently rather different. At present, many of the Sri Lankans in Raja Nagar have returned to Sri Lanka following the peace process. Though the formations and structures presented in this dissertation still largely prevail, future studies on this population need to incorporate the emerging peace process and the consequent possibilities which have surfaced. People can now move freely back and forth between India and Sri Lanka, and the opening up of the LTTE controlled areas has also led to increasing economic possibilities for this population. In spite of the ongoing, though currently deadlocked peace process, many Sri Lankans have chosen to remain in India which many now consider their home.

Appendices

Appendix 1: Map of Tamil Nadu



Appendix 2: Map of Sri Lanka



Base 802734AI (C00127) 3-01

Appendix 3: List of informants

Name	M/F	Age	Place of origin	Year of migration from Sri Lanka	Places of residence before India	Means of arrival to India	Caste	Current job	Family in India	Family in Europe (West)	Family in Sri Lanka
Aadalarasu	M	33	Eastern Sri Lanka	1991		Boat		Local job	W		
Ambiga	F	33	Central Sri Lanka	1993		Plane	Asani	Own business	H,S,D,M,F,B,B	-	
Aracheli	F	17	Jaffna	1985		Plane	Vellala	Student	MM,M,B	++	F
Chandran	M	50	Akshadipuram	Indian citizen		-	Kallar	No job	All	-	
Deva	M	18	Akshadipuram	Indian citizen		-	Kallar	Student	All		
Devani	F	23	Colombo	1984		Plane	Thevar	Local job	F,Z	H	
Dharmalingam	M	60	Valvetiturai, Jaffna			Boat	Karaiyar	No job	W,D,D,B	B,D,D,D,D,S	D,Z
Garnet	M	49	Sri Lankan Hill Country	1984		Plane	Christian, Udayar	No job	-	-	M,F,Z,B
Illango	M	17	Valvetiturai, Jaffna	1993		Plane	Karaiyar	Student	F,M,B,B	B,B,Z	
Jegan	M	62	Jaffna	1990		Boat	Vellala	No job	W	S,D,D,D	
Jeyadhani	F	45	Valvetiturai, Jaffna	1993		Plane	Karaiyar	Housewife	H,S,S,(S),B,Z,Z	S,S,D,B	Z
Kannan	M	46	Akshadipuram	Indian citizen		-	Christian	Local job	All		
Mahadevi	F	23	Colombo	1983		Ferry	Thevar	Local job	W,D,D	-	
Mahesan	M	72	Colombo				Christian	Local job			
Mala	F	42	Chavakachcheri, Jaffna	1996		Boat	Vellala	Housewife	S,S,S	H	
Murugan	M	23	Point Pedro, Jaffna	1997		Boat	Karaiyar	Local job	M,F,Z	B,Z,Z	
Muthalingam	M	65	Jaffna			Plane	Christian Vellala	Local job	W,S		
Radha	F	21	Colombo	1984		Plane	Thevar	Student	F,Z	-	
Raja	M	28	Colombo	Resident in SL		-	Brahmin	Marketing	-	-	All
Rajkumar	M	42	Eastern Sri Lanka	1993		Plane	Asani	Own business	W,S,D	-	B,Z,Z,B
Ramanujan	M	70	Jaffna	1984	Malaysia	Plane	Vellala	No job	W,S,D,D,D	B,B,Z	
Ramaswamy	M	50	Colombo, Central Sri	1984		Plane	Thevar	Agent work	D,D	-	Z
Rani	F	19	Colombo	1999		Plane		Local job	F,M,B	-	?
Ravi	M	35	Colombo			Plane		Own business	W,S,D		
Ravichandran	M	24	Valvetiturai, Jaffna	1993		Plane	Karaiyar	Student	F,M,B,(B)	B,B,Z	
Selvaraj	M	21	Valvetiturai, Jaffna	1993		Plane	Karaiyar	Student	F,M,B,(B)	B,B,Z	
Shankar	M	33	Akshadipuram/Sri Lankan	Indian citizen	Switzerland	-		Local job	F,W,Z	B	
Sivan	M	50	Akshadipuram/Sri Lankan	1980 [Repatriate]				No job	W++		B
Sivanesan	M	55	Colombo	1983		Ferry	S.C	No job	W,D,D	-	B,B
Sonali	F	65	Point Pedro, Jaffna	1996		Boat	Karaiyar	Housewife	H,B,B,Z,Z	S,S,D,S,D,B	Z,B
Sudhasingam	M	45	Valvetiturai, Jaffna	1986		Boat	Karaiyar	Own business	W,D	S,S,S,D	
Thirumal	M	33	Jaffna	1986		(Europe)	Karaiyar	Own business	++	++	
Velan	M	70	Jaffna	1990		Boat	Vellala	Local job	D	W,S,D	

Appendix 4: Sonali's family

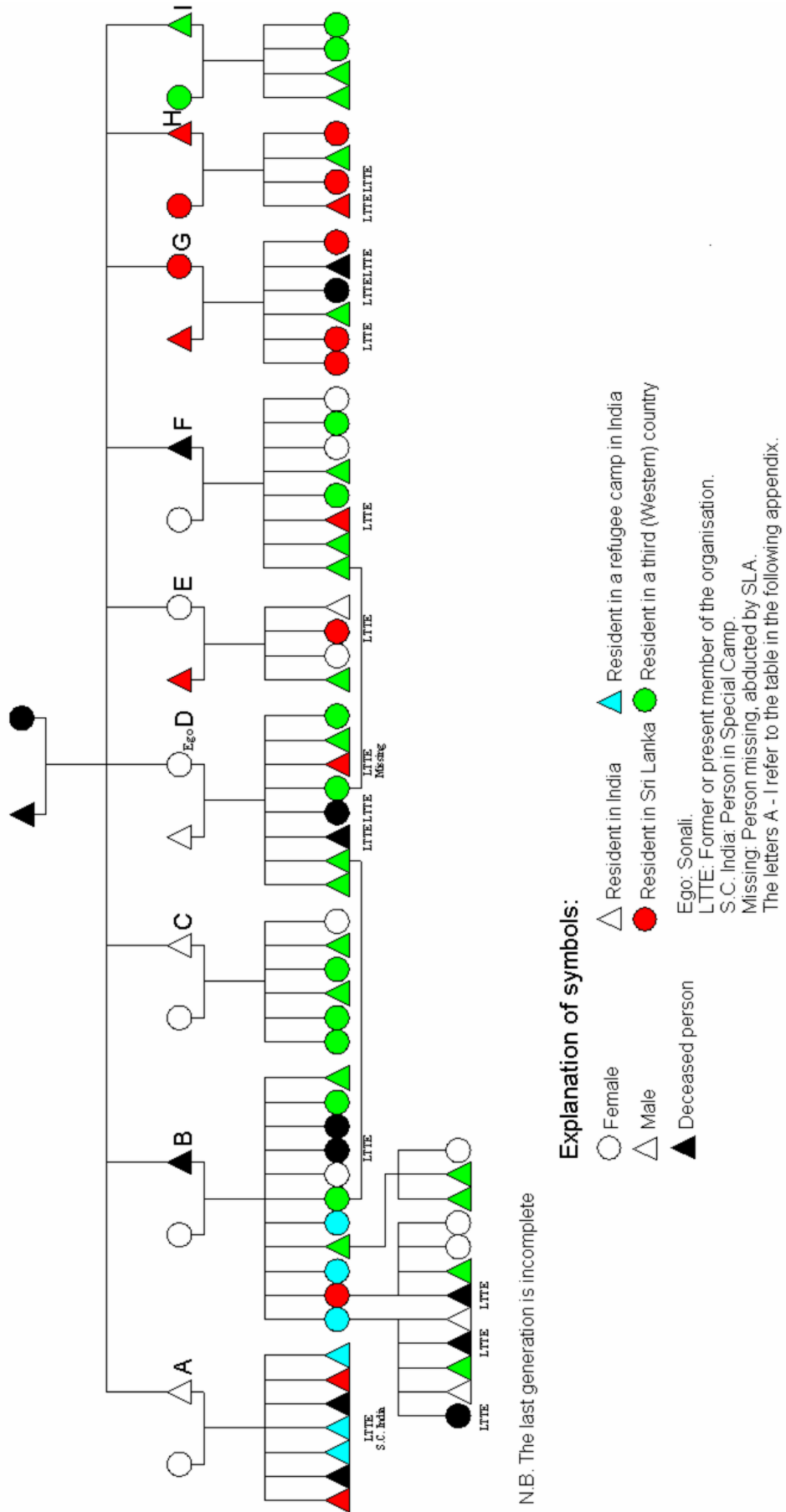

N.B. The last generation is incomplete

Appendix 5: Settlement patterns in Sonali's family

	M	F	Deceased/ Missing	India	Camps in India	Sri Lanka	3rd country
A	M			Akhdp.			
AA		F		Akhdp.			
a1	M		Deceased		Mandapam Sp. Camp	Vanni	
a2	M						
a3	M						
a4	M						
a5	M						
a6	M						
a7	M					Ordinary	Mullaittivu
B	M		Deceased				
BB		F		Akhdp.			
b1		F	Deceased	India	Ordinary		
b1a		F					
b1b	M						
b1c	M					UK	
b1d	M						
b1e	M						
b2		F				Mullaittivu	
b2a	M					UK	
b2b	M						
b2c	F						
b2d	F						
b3		F	Mandapam				
b4	M			NOR			
b4a	M			NOR			
b4b	M			NOR			
b4c		F	Akhdp.				
b5		F	Ordinary				
b6		F		UK			
b7		F	Akhdp.				
b8		F	Deceased				
b9		F	Deceased				
b10		F		UK			
b11	M			UK			
C	M			Akhdp.			
CC		F		Akhdp.			
c1		F					NOR
c2		F					SUI
c3	M						NOR
c4		F					ITA
c5	M						NOR
c6		F		Akhdp.			
D		F		Akhdp.			
DD	M			Akhdp.			
d1	M						UK
d2	M						UK
d3	M		Deceased				
d4		F	Deceased				
d5		F					UK
d6	M		Missing				
d7	M						UK
d8		F					UK

	M	F	Deceased/ Missing	India	Camps in India	Sri Lanka	3rd country
E				Akhdp.			
EE	M					Mullaittivu	
e1	M						UK
e2		F		Akhdp.			
e3		F				LTTE	
e4	M			Akhdp.			
F	M		Deceased				
FF		F		Akhdp.			
f1	M						UK
f2	M						UK
f3	M					LTTE	
f4		F					FRA
f5	M						UK
f6	M			Akhdp.			
f7		F					UK
f8		F		Akhdp.			
G		F				Mullaittivu	
GG	M					Mullaittivu	
g1		F				Mullaittivu	
g2		F				Mullaittivu	
g3	M						UK
g4		F	Deceased				
g5	M		Deceased				
g6		F				Mullaittivu	
H	M					Mullaittivu	
HH		F				Mullaittivu	
h1	M					LTTE	
h2		F				LTTE	
h3	M						UK
h4		F				Mullaittivu	
I	M						UK
II		W					UK
i1	M						UK
i2	M						UK
i3		W					UK
i4		W					UK
88	46	42	13 / 1	18	6	16	32

Explanation:
The table is a reflection of Sonali's kinship map presented as Appendix 1. Grey and bold refer to Sonali's generation, a1, a2 etc. to A's children, and a1a, a1b etc. to the children of a1 etc. M/F indicates male or female person. The other columns reflect settlement: the place of residence in India, type of camp, place of residence in Sri Lanka and place of residence in a third country,

Appendix 6: Jeyadhani's family

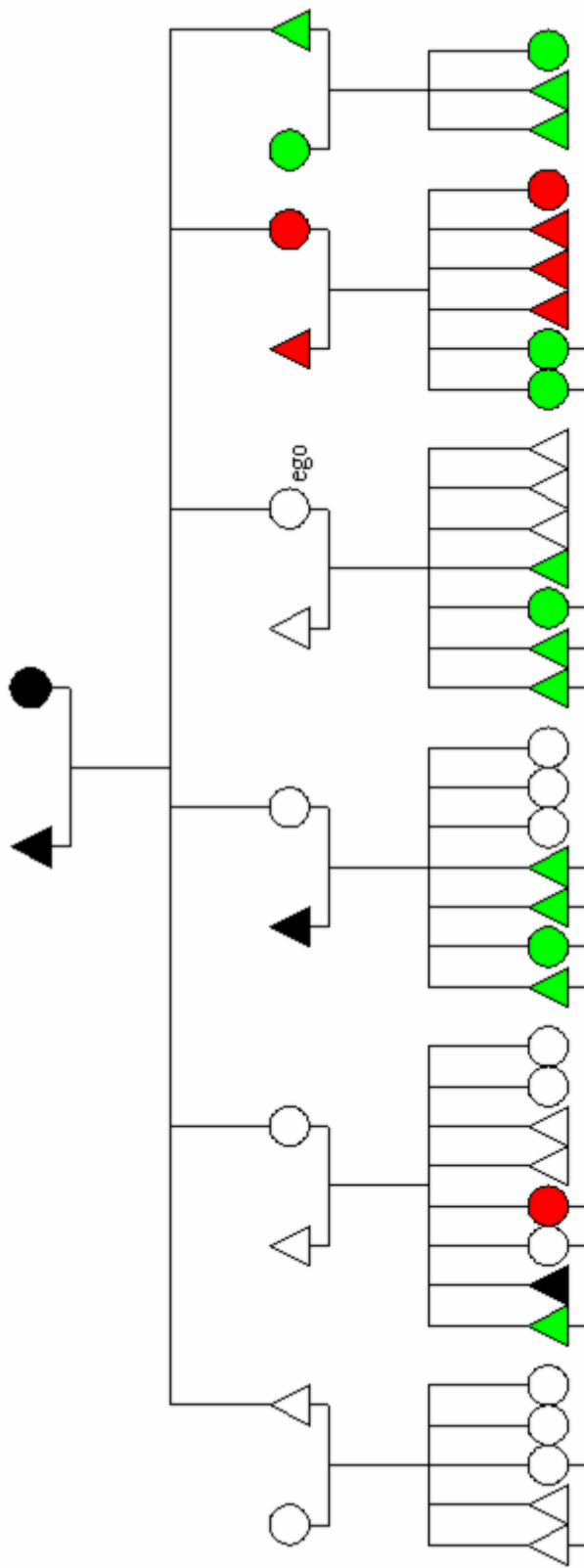

Explanation of symbols:

- Female
- △ Male
- ▲ Deceased person
- Resident in India
- Resident in Sri Lanka
- Resident in a third (Western) country
- Ego: Jeyadhani

Appendix 7: Rajkumar's family

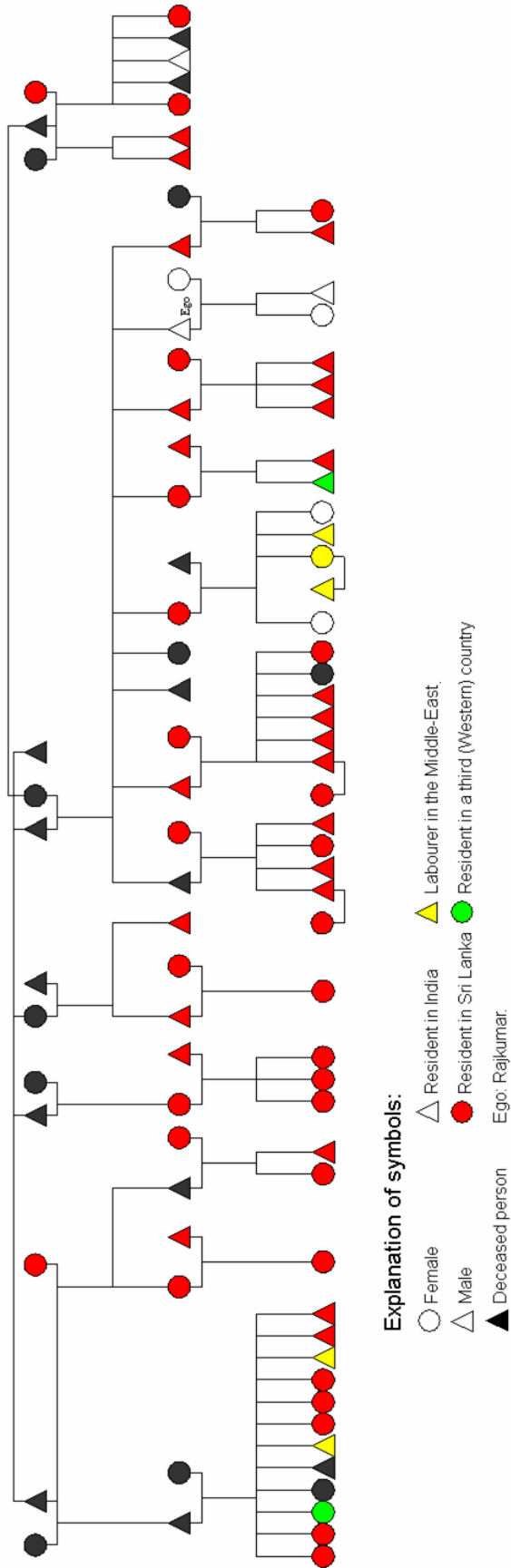

Bibliography

- AMAL RAJ, FR.C. (1997)
'Sri Lankan Tamil refugees in India. Accords, people and UNHCR', in *States, Citizens and Outsiders. The Uprooted Peoples of South Asia*. Bose, Tapan K. and Rita Manchanda (eds). pp.:190-202. Kathmandu: South Asia Forum for Human Rights.
- ANDERSON, BENEDICT (1996)
Forestilte Fellesskap: Refleksjoner omkring nasjonalismens opprinnelse og spredning. Oslo: Spartacus Forlag.
- ANTHIAS, FLOYA (1998)
'Evaluating 'Diaspora': Beyond Ethnicity?' in *Sociology*. Vol.32 (3). pp.:557-580.
- APPADURAI, ARJUN (1991)
'Global Ethnoscapes. Notes and Queries for a 'Transnational Anthropology', in *Recapturing Anthropology. Working in the Present*. Fox, Richard G. (ed.). pp.:191-210. Santa Fe, New Mexico: School of American Research Press.
- (1995)
'The production of locality', in "*Counterworks*", *Managing the Diversity of Knowledge*. Fardon, Richard (ed.). pp.:204-225. London: Routledge.
- APPADURAI, ARJUN and CAROL A. BRECKENRIDGE (1988)
'Why Public Culture?' in *Public Culture. Bulletin of the Project for Transnational Cultural Studies*. Vol.1 (1). pp.:5-9.
- BALASINGHAM, ADELE (2001)
The Will to Freedom, An Inside View of Tamil Resistance. Mitcham: Fairmax Publishing Ltd.
- BALLARD, ROGER (2003)
'A Background Report on the Operation of Informal Value Transfer Systems (Hawala)'. The Centre for Applied South Asian Studies, <http://www.art.man.ac.uk/CASAS/pdfpapers/hawala.pdf> - Accessed: 18. February 2005.
- BANKS, MICHAEL (1960)
'Caste in Jaffna', in *Aspects of Caste in South India, Ceylon and North-West Pakistan*. Leach, E.R. (ed.). pp.:61-78. Cambridge: Cambridge University Press.
- BARFIELD, THOMAS (1997)
The Dictionary of Anthropology. Oxford: Blackwell Publishers Ltd.
- BARTH, FREDRIK (1969)
'Introduction', in *Ethnic groups and boundaries*. Barth, Fredrik (ed.). pp.:9-38. Oslo: Universitetsforlaget.
- BASTIAMPILLAI, BERTRAM (1996)
'Sri Lankan Tamil Refugees in Tamil Nadu: Trouble to the Host', in *Refugees and Regional Security in South Asia*. Muni, S.D. and Lok Raj Baral (eds). pp.:194-218. Delhi: Konark Publishers Pvt. Ltd.
- BERNARD, H. RUSSELL (1994)
'Methods belonging to all of us', in *Assessing Cultural Anthropology*. Borofsky, Robert (ed.). pp.:168-176. New York: McGraw-Hill Inc.
- BÉTEILLE, ANDRÉ (1996)
'Varna and Jati', in *Sociological Bulletin*. Vol.45 (1). pp.:15-27.

- BÉTEILLE, ANDRÉ (1997)
 'Caste and Political Group Formation in Tamilnad', in *Politics in India*. Kaviraj, Sudipta (ed.). pp.:71-94. Delhi: Oxford University Press.
- BLOCH, MAURICE (1993)
 'Zafimaniry birth and kinship theory', in *Social Anthropology*. Vol.1 (1B). pp.:119-132.
- BOSE, TAPAN K. (2000)
Protection of Refugees in South Asia: Need for a Legal Framework. Kathmandu: South Asia Forum for Human Rights.
- BOURDIEU, PIERRE (1977)
Outline of a Theory of Practice. Cambridge: Cambridge University Press.
- (1990)
 'Structure, habitus, power: basis for a theory of symbolic power', in *Power/Culture/History: A reader in contemporary social theory*. Dirks, N.B., G. Eley and S.B. Ortner (eds). pp.:155-199. Cambridge: Cambridge University Press.
- BRUNER, EDWARD M. (1986)
 'Ethnography as Narrative', in *The Anthropology of Experience*. Turner, V.W. and E.M. Bruner (eds). pp.:139-155. Urbana and Chicago: University of Illinois Press.
- CHANDRAHASAN, N. (1989)
 'A Precarious Refuge: A Study of the Reception of Tamil Asylum-Seekers into Europe, North America and India', in *Harvard Human Rights Yearbook*. Vol.2. pp.:55-96.
- CHERAN, R. (2001)
The Sixth Genre: Memory, History and the Tamil Diaspora Imagination. Marga Monograph Series on Ethnic Reconciliation (Vol. 7). Colombo: Marga Institute.
- CLIFFORD, JAMES (1994)
 'Diasporas', in *Cultural Anthropology*. Vol.9 (3). pp.:302-338.
- COHEN, ROBIN (1996)
 'Diasporas and the Nation-State: From Victims to Challengers', in *International Affairs (Royal Institute of International Affairs 1944-)*. Vol.72 (3). pp.:507-520.
- (1997)
Global Diasporas. An Introduction. London: UCL Press.
- DALAL, RAMESH (2001)
Rajiv Gandhi's Assassination: The Mystery Unfolds. New Delhi: UBS Publishers' Distributors Ltd.
- DANIEL, E.VALENTINE (1984)
Fluid Signs. Being a Person the Tamil Way. Berkley: University of California Press.
- (1996)
Charred Lullabies. Chapters in and Anthropology of Violence. Princeton: Princeton University Press.
- DANIEL, E.VALENTINE and JOHN CHR. KNUDSEN (1995)
 'Introduction', in *Mistrusting Refugees*. Daniel, E.Valentine and John Chr. Knudsen (eds). pp.:1-12. Berkley: University of California Press.
- DANIEL, E.VALENTINE and YUVARAJ THANGARAJ (1995)
 'Forms, Formations, and Transformations of the Tamil Refugee', in *Mistrusting Refugees*. Daniel, E.Valentine and John Chr. Knudsen (eds). pp.:225-257. Berkley: University of California Press.
- DANIEL, SHERYL B. (1980)
 'Marriage in Tamil Culture: The Problem of Conflicting "Models"', in *The Powers of Tamil Women*. Wadley, Susan S. (ed.). pp.:61-92. New York: Syracuse University.

- DAVIS, ANTHONY (1996)
 'Tiger International: how a secret global network keeps Sri Lanka's Tamil guerrilla organisation up and killing', in *Asiaweek*. (26 July 1996) <http://www.asiaweek.com/asiaweek/96/0726/cs1.html>.
- DE MEL, NELOUFER (2001)
Women & the Nation's Narrative. Gender and Nationalism in Twentieth Century Sri Lanka. Lanham: Rowman & Littlefield Publishers, Inc.
- DE SILVA, K.M. (1981)
A History of Sri Lanka. Delhi: Oxford University Press.
- (1998)
Reaping the Whirlwind. Ethnic Conflict, Ethnic Politics in Sri Lanka. New Delhi: Penguin Books India (P) Ltd.
- DICKEY, SARA (1993)
 'The Politics of Adulation: Cinema and the Production of Politicians in South India', in *Journal of Asian Studies*. Vol.52 (2). pp.:340-372.
- DOUGLAS, MARY (1990)
 'Foreword: No free gifts', in *The Gift. The form and reason for exchange in archaic societies*, (ed.) Mauss, Marcel London: Routledge
- DUFOIX, STÉPHANE (2001)
 'Chronique bibliographique: l'objet diaspora en questions', in *Cultures & Conflits*. Vol.33-34 - Les anonymes de la mondialisation.
- DUMONT, LOUIS (1980)
Homo Hierarchicus: The Caste system and its Implications. Chicago: The University of Chicago Press.
- EELENS, FRANK and J.D. SPECKMANN (1990)
 'Recruitment of Labor Migrants for the Middle East: The Sri Lankan Case', in *International Migration Review*. Vol.24 (2). pp.:297-322.
- EWING, KATHERINE P. (1990)
 'The Illusion of Wholeness: Culture, Self, and the Experience of Inconsistency', in *Ethos*. Vol.18 (3). pp.:251-278.
- FELDMAN, ALLEN (1991)
Formations of Violence. The Narrative of the Body and Political Terror in Northern Ireland. Chicago: University of Chicago Press.
- FOUCAULT, MICHEL (1980)
Power/Knowledge, Selected Interviews and Other Writings 1972-1977. Gordon, Colin (ed.). New York: Pantheon Books.
- (1999a)
Diskursens Orden. Oslo: Spartacus Forlag A/S.
- (1999b)
Overvåkning og straff. Det moderne fengsels historie. Oslo: Gyldendal forlag.
- FUGLERUD, ØIVIND (1997)
 'Identitet blant eksiltamiler', in *Sri Lanka: Nasjonalisme identitet og migrasjon*. Hollup, Oddvar and Kristian Stokke (eds). pp.:97-115. Oslo: Tano Aschehoug.
- (1999)
Life on the Outside. The Tamil Diaspora and Long Distance Nationalism. London: Pluto Press.
- (2001)
Migrasjonsforståelse. Flytteprosesser, rasisme og globalisering. Oslo: Universitetsforlaget.

- GARDNER, KATY (1995)
Global Migrants, Local Lives. Travel and Transformation in Rural Bangladesh. Oxford: Clarendon Press.
- GEERTZ, CLIFFORD (1967)
 'The integrative revolution, Primordial sentiments and civil politics in the new states', in *Old Societies and New States. The Quest for modernity in Asia and Africa.* Geertz, Clifford (ed.). pp.:105-157. New York: The Free Press.
- GELLNER, ERNEST (1983)
Nations and Nationalism. Oxford: Basil Blackwell.
- GHOSH, AMITAV (2002)
 'The diaspora in Indian culture', in *The Imam and the Indian: Prose Pieces.* Ghosh, Amitav (ed.). pp.:243-250. New Delhi: Ravi Dayal Publisher & Permanent Black.
- GLEDHILL, JOHN (1994)
 'Anthropology and politics: commitment, responsibility, and the academy', in *Power and its disguises. Anthropological perspectives on politics.* Gledhill, John (ed.). pp.:207-228. London: Pluto Press.
- GUNARATNA, ROHAN (1993)
Indian Intervention in Sri Lanka, The Role of India's Intelligence Agencies. Colombo: South Asian Network on Conflict Research.
- GUNAWARDANA, R.A.L.H. (1990)
 'The people of the lion: the Sinhala identity and ideology in history and historiography', in *Sri Lanka: History and the Roots of Conflict.* Spencer, Jonathan (ed.). pp.:45-86. London: Routledge.
- GUPTA, AKHIL (1995)
 'Blurred boundaries: the discourse if corruption, the culture of politics, and the imagined state', in *American Ethnologist.* Vol.22. pp.:375-402.
- GUPTA, AKHIL and JAMES FERGUSON (1997)
 'Discipline and practice: "The Field" as site, method and location in anthropology', in *Anthropological Locations.* Gupta, Akhil and James Ferguson (eds). pp.:1-46. Berkley: University of California Press.
- HAMMERSLEY, MARTYN and PAUL ATKINSON (1987)
Feltmetodik, Grunnlaget for feltarbeid og feltforskning. Oslo: Gyldendal.
- HANNERZ, ULF (1989)
 'Culture Between Centre and Periphery: Towards a Macroanthropology', in *Ethnos.* (54). pp.:200-216.
- HELLMANN-RAJANAYAGAM, DAGMAR (1990)
 'The politics of the Tamil past', in *Sri Lanka: History and the Roots of Conflict.* Spencer, Jonathan (ed.). pp.:107-122. London: Routledge.
- HERADSTVEIT, DANIEL and TORE BJØRGO (1996)
Politisk kommunikasjon. Oslo: TANO A/S.
- HOCART, A.M. (1950)
Caste. A Comparative Study. London: Methuen & Co. Ltd. London.
- HOLY, LADISLAV (1984)
 'Theory, method and the research process', in *Ethnographic Research: a guide to general conduct.* Ellen, Roy F. (ed.). pp.:13-34. London: Academic Press.
- HOOLE, S.R.H (1997)
The Exile Returned: A self-portrait of the Tamil Vellablabs of Jaffna, Sri Lanka. Colombo: Aruvi Publishers.
- INDEN, RONALD B. (1990)
Imagining India. London: Hurst & Company.

BIBLIOGRAPHY

- JENKINS, JONATHAN (1996)
Social identity. London: Routledge.
- KAPFERER, BRUCE (1988)
Legends of People, Myths of State, Violence, Intolerance, and Political Culture in Sri Lanka and Australia. London: Smithsonian Institution Press.
- (2000)
'Star Wars: About Anthropology, Culture and Globalisation', in *The Australian Journal of Anthropology*. Vol.11 (2). pp.:174-198.
- KAUR, NAUNIDHI (2002)
'No real refuge', in *Frontline*. Vol.19 (16) Aug.3-16. pp.:73-75.
- KEARNEY, MICHAEL (1986)
'From the Invisible Hand to Visible Feet: Anthropological Studies of Migration and Development', in *Annual Anthropology Review*. Vol.15. pp.:331-361.
- KEESING, ROGER M. (1989)
'Creating the Past: Custom and Identity in the Contemporary Pacific', in *The Contemporary Pacific*. Vol.1 (1-2). pp.:19-42.
- KHILNANI, SUNIL (1997)
The Idea of India. New Delhi: Penguin Books.
- KNUDSEN, JOHN CHR. (1990)
'Cognitive models in life histories', in *Anthropological Quarterly*. Vol.63 (3). pp.:122-134.
- (1995)
'When Trust is on Trial', in *Mistrusting Refugees*. Daniel, E.Valentine and John Chr. Knudsen (eds). pp.:13-36. Berkley: University of California Press.
- KOTTAK, CONRAD and ELIZABETH COLSON (1994)
'Multilevel Linkages: Longitudinal and Comparatives Studies', in *Assessing Cultural Anthropology*. Borofsky, Robert (ed.). pp.:396-410. New York: McGraw-Hill inc.
- KRISHNA, SANKARAN (1998)
'Divergent Narratives: Dravidian and Eelamist Tamil Nationalism', in *Sri Lanka. Collective Identities Revisited Volume II*. Roberts, Michael (ed.). pp.:315-346. Colombo: Marga Institute.
- KÅRTVEIT, BÅRD HELGE (2003)
"In the US I'm an Arab terrorist, here I'm an American punk!" En studie av palestinske returmigrasjon og identitetsbåndtering på Vestbredden. Thesis submitted in partial fulfilment of the Cand. Polit. Degree. Bergen: University of Bergen.
- LUDOWYK, E.F.C. (1962)
The Story of Ceylon. London: Faber and Faber.
- MALKKI, LIISA (1992)
'National Geographic: The Rooting of Peoples and the Territorialization of National Identity Among Scholars and Refugees', in *Cultural Anthropology*. Vol.7 (1). pp.:24-44.
- (1995a)
Purity and Exile: Violence, Memory and National Cosmology among Hutu Refugees in Tanzania. Chicago: University of Chicago Press.
- (1995b)
'Refugees and Exile: From "Refugee Studies" to the National Order of Things', in *Annual Review of Anthropology*. Vol.24. pp.:495-523.
- MANGER, LEIF (2001)
The Concept of Diaspora and the Theorising of Identity. Paper presented at conference on "The Concept of Diaspora and the Theorising of Identity": University of Bergen and International Migration and Ethnic Relations program (IMER): September 5. 2001.

- MANU (1991)
The Laws of Manu. London: Penguin Books.
- MATHIESEN, THOMAS (1999)
 'Forord', in *Overvåkning og straff. Det moderne fengsels historie*. Foucault, Michel (ed.). Oslo: Gyldendal forlag.
- MAUSS, MARCEL (1990)
The Gift. The form and reason for exchange in archaic societies. London: Routledge.
- MCDOWELL, CHRISTOPHER (1996)
A Tamil Asylum Diaspora, Sri Lankan Migration, Settlement and Politics in Switzerland. Refugee and Forced Migration Studies (Vol. 1). Oxford: Berghahn Books.
- MUNI, S. D. (1993)
Pangs of Proximity: India and Sri Lanka's ethnic crisis. Oslo: PRIO: Sage Publications.
- NARAYAN SWAMY, M. R. (1994)
Tigers of Lanka: from boys to guerrillas. Delhi: Konark Publishers Pvt. Ltd.
- PFaffenBERGER, BRYAN (1994)
 'The Political Construction of Defensive Nationalism: The 1968 Temple Entry Crisis in Sri Lanka', in *The Sri Lankan Tamils. Ethnicity and Identity*. Manogaram, Chelvadurai and Bryan Pfaffenberger (eds). pp.:143-168. Boulder: Westview Press.
- PRICE, PAMELA (1996)
 'Revolution and Rank in Tamil Nationalism', in *Journal of Asian Studies*. Vol.55 (2). pp.:359-383.
- PUCL (2000)
Memorandum sent to CM, Government of Tamil Nadu. Sub.: Forcible transfer of Sri Lankan Refugees from Special Camp for Refugees, Vellore to Special Camp, Melur - Indefinite Fast - Request Urgent Intervention to stop transfer. Chennai: PUCL.
- RAJASINGHAM-SENANAYAKE, DARINI (2002)
 'Identity on the Borderline: Modernity, New Ethnicities, and the Unmaking of Multiculturalism in Sri Lanka', in *The Hybrid Island. Culture crossings and the invention of identity in Sri Lanka*. Silva, Neluka (ed.). pp.:41-70. Colombo: Social Scientists' Association.
- RAMANA, P.V (2004)
 'Left Wing Extremism in India', in *Observer Research Foundation*. <http://www.observerindia.com/analysis/A072.htm> - accessed 18.07.2004.
- RAMASWAMY, SUMATHI (1993)
 'En/Gendering Language: The Poetics of Tamil Identity', in *Comparative Studies in Society and History*. Vol.35 (4). pp.:683-725.
- REFUGEE COUNCIL, THE (1999)
Sri Lanka refugees in the Indian State of Tamil Nadu. The Sri Lanka project. London: The Refugee Council.
- ROGERS, JOHN D. (1990)
 'Historical images in the British period', in *Sri Lanka: History and the Roots of Conflict*. Spencer, Jonathan (ed.). pp.:87-106. London: Routledge.
- ROOSENS, EUGEN (1994)
 'The primordial nature of origins in migrant ethnicity', in *The Anthropology of Ethnicity: Beyond "Ethnic Groups and Boundaries"*. Vermeulen, Hans and Cora Govers (eds). pp.:81-104. Amsterdam: Het Spinhuis.
- RYNTVEIT, ANNE KIRSTI (1996)
Kampen for Tamil Eelam: framveksten i militant tamilske separatistnasjonalisme i Sri Lanka. Thesis submitted in partial fulfilment of the Cand. Polit. Degree. Bergen: University of Bergen.

- RØDSETH, EIRIN (1999)
"Dette er ikke vår kultur": en analyse av religiøse og kulturelle endringsprosesser blant muslimer på Sri Lanka. Thesis submitted in partial fulfilment of the Cand. Polit. Degree. Bergen: University of Bergen.
- SAFRAN, WILLIAM (1991)
 'Diasporas in Modern Societies: Myths of Homeland and Return', in *Diaspora*. Vol.1. pp.:83-99.
- SAHRDC (1995)
The Status of Refugees under the Protection of the UNHCR in New Delhi. New Delhi: SAHRDC.
- - South Asia Human Rights Documentation Centre (2002.02.25a)
 'Country Report on the Refugee situation in India'. <http://www.hri.ca/partners/sahrdc/refugee/fulltext.shtml>. - Accessed: 25. February 2002.
- - South Asia Human Rights Documentation Centre (2002.02.25b)
 'Refugee Protection in India - October 1997'. <http://www.hri.ca/partners/sahrdc/refugee-protection/fulltext.shtml>. - Accessed: 25. February 2002.
- - South Asia Human Rights Documentation Centre (2002.02.27)
 'Alternate Report and Commentary - July 1997'. www.hri.ca/partners/SAHRDC/alternate/fulltext.shtml. - Accessed: 27. February 2002.
- SAMARASINGHE, S.W.R. DE A. and VIDYAMALI SAMARASINGHE (1998)
Historical Dictionary of Sri Lanka. Asian/Oceanian Historical Dictionaries (Vol. 26). London: The Scarecrow Press Inc.
- SCHALK, PETER (1992)
 "'Birds of Independence". On the Participation of Tamil Women in Armed Struggle', in *Lanka*. Vol.7. pp.:44-142.
- (1997)
 'Resistance and Martyrdom in the Process of State Formation of Tamililam', in *Martyrdom and Political Resistance. Essays from Asia and Europe.* Pettigrew, Joyce (ed.). pp.:61-85. Amsterdam: VU University Press for Centre for Asian Studies.
- SCHUTZ, ALFRED (1970)
On Phenomenology and Social Relations, Selected Writings. Chicago and London: University of Chicago Press.
- SHANMUGATHASAN, N. (1997)
 'Caste Struggles in Northern Sri Lanka', in *Matters of Violence, Reflections on Social and Political Violence in Sri Lanka.* Uyangoda, Jayadeva and Janaka Biyanwila (eds). pp.:95-106. Colombo: Social Scientists' Association.
- SOOSAI, JOSEPH (1998)
Community based Holistic Health Intervention among the Camp Refugees in Tamil Nadu. Unpublished paper.
- STEIN, BARRY N. (1981)
 'The Refugee Experience: Defining the Parameters of a Field of Study', in *International Migration Review*. Vol.15 (1/2). pp.:320-330.
- STOKKE, KRISTIAN (1997)
 'Singalesisk og tamilsk nasjonalisme som politiske prosjekt', in *Sri Lanka: Nasjonalisme identitet og migrasjon.* Hollup, Oddvar and Kristian Stokke (eds). pp.:23-43. Oslo: Tano Aschehoug.
- SUBRAMANIAN, NARENDRA (1999)
Ethnicity and Populist Mobilisation. Political Parties, Citizens and Democracy in South India. New Delhi: Oxford University Press.

BIBLIOGRAPHY

- SUBRAMANIAN, T.S. (2000)
'Jail Term for Jayalalitha', in *Frontline*. Vol.17 (21) Oct. 14. - 27. <http://www.flonnet.com/fl1721/17210040.htm>.
- (2002)
'To divide and rule', in *Frontline*. Vol.19 (16) Aug. 3-16. pp.:33-34.
- SURYANARAYAN, V. (1996)
'Sri Lankan Tamil Refugees in Tamil Nadu', in *Refugees and Regional Security in South Asia*. Muni, S. D. and Lok Raj Baral (eds). pp.:219-224. Colombo: Konark Publishers Pvt. Ltd.
- SURYANARAYAN, V. and V. SUDARSEN (2000)
Between Fear and Hope: Sri Lankan Refugees in Tamil Nadu. Chennai: T.R.Publications.
- TAMBIAH, DR. H.W. (2001)
The Laws and Customs of the Tamils of Jaffna. Colombo: Women's Education & Research Centre.
- TAMBIAH, STANLEY JEYARAJA (1986)
Sri Lanka : Ethnic Fratricide and the Dismantling of Democracy. Chicago: The University of Chicago Press.
- (1992)
Buddhism betrayed? : religion, politics, and violence in Sri Lanka. A Monograph of the World Institute for Development Economics Research (WIDER) of the United Nations University. Chicago: University of Chicago Press.
- THIRUVALLUVAR (1990)
The Kural. New Delhi: Penguin Books.
- TUMMALA, KRISHNA K. (1992)
'India's Federalism under Stress', in *Asian Survey*. Vol.32 (6). pp.:538-553.
- TURNER, VICTOR (1967)
'Betwixt and Between: The Liminal Period in Rites de Passage', in *The Forest of Symbols*. Ithaca: Cornell University Press.
- (1991)
The Ritual Process, Structure and Anti-Structure. New York: Aldine de Gruyter.
- UNHCR (1999)
Background paper on Sri Lanka for the European Union High Level Working Group On Asylum And Migration. Geneva: UNHCR.
- VAN HEAR, NICHOLAS (2000)
Sustaining societies under strain: remittances as a form of transnational exchange in Sri Lanka and Ghana. Revision of paper prepared for the conference 'New approaches to migration: transnational communities and the transformation of home: University of Sussex, September 1999.
- (2003)
From durable solutions to transnational relations: home and exile among refugee diasporas. Working Paper No.83 - UNHCR Evaluation and Policy Analysis Unit. Copenhagen: Centre for Development Research.
- VISWANATHAN, S. (1998)
'Caste-based mobilisation and violence', in *Frontline*. Vol.15 (22) Oct.24-Nov.06. <http://www.flonnet.com/fl1522/15220360.htm>.
- (2000)
'The doublespeak of Tamil Nadu', in *Frontline*. Vol.17 (13) Jun.24-Jul.07. <http://www.frontlineonnet.com/fl1713/17130330.htm>.
- (2004)
'Recognising a Classic', in *Frontline*. Vol.21 (22) Oct.23-Nov.5. pp.:106-109.

- WAGNER, HELMUT R. (1970)
 'Introduction', in *On Phenomenology and Social Relations, Selected Writings*, (ed.) Schutz, Alfred. pp.:1-50 Chicago and London: University of Chicago Press
- WILSON, A.JEYARATNAM (1988)
The Break-Up of Sri Lanka. The Sinhalese-Tamil Conflict. Honolulu: University of Hawaii Press.
- (2000)
Sri Lankan Tamil Nationalism. Its Origins and Development in the 19th and 20th Centuries. London: Hurst & Company.

NEWSPAPERS

- DINAMALAR (2000.07.09)
 'Meenavarkalāl kadaththappadda akathippen udalai poolechār kaipparrinar (Police retrieve the body of the refugee girl kidnapped by the fishermen)',
- EXPRESS INDIA (1997.11.22)
 'Arafat had warned Rajiv about life threats', Electronic edition <http://expressindia.com/ie/daily/19971122/32650343.html> - accessed 18. March 2003.
- (1998.07.11)
 'Dowry death: 4 in Patiala jail', Electronic edition <http://www.expressindia.com/ie/daily/19980711/19251314.html> - accessed 18. November 2003.
- INDIAN EXPRESS (1999.05.12)
 'Death rap for four in Rajiv case upheld', Electronic edition <http://www.expressindia.com/ie/daily/19990512/ige12061.html> - accessed 16. March 2004.
- (2000.06.09)
 'Peoples Watch decries stand on refugees', Chennai edition.
- NEWINDPRESS (2003.06.10)
 'Special camp for refugees to be shifted', Electronic edition <http://www.newindpress.com/Newsitems.asp?ID=IET20030609131228&Title=Southern+News+-+Tamil+Nadu&rLink=0> - Accessed 22. January 2004.
- TAMILNATION - (2005.02.08)
 'Tamil Diaspora - A Trans State Nation'. <http://www.tamilnation.org/diaspora/index.htm>. - Accessed: 8. February 2005.
- THE HINDU (1990.06.28)
 'Decision on deportation soon', Madras edition
- (1991.07.15)
 '25000 Sri Lankans Tamils report to police', Madras edition
- (1991.07.23)
 'Sri Lankan Tamils being interrogated.' Madras edition
- (2000.01.07)
 'Robbery bid: pistol recovered', Chennai edition.
- (2000.01.11)
 'Rs. 34 cr. worth heroin seized', Chennai edition.
- (2000.05.19)
 'Tamil refugee-free week declared', Bangalore edition.
- (2000.06.02)
 '15 more Tamil refugees arrive', Electronic edition <http://www.hinduonnet.com/thehindu/2000/06/02/stories/04022232.htm> - accessed 10. March 2002.

BIBLIOGRAPHY

THE HINDU (2000.06.07)

'Compulsions behind suggestion', Chennai edition.

——— (2000.06.11)

'Incendiary influx', Bangalore edition.

——— (2000.07.08)

'Sri Lankan Tamil girl kidnap: one held', Electronic edition <http://www.hinduonnet.com/thehindu/2000/07/08/stories/04082234.htm> - accessed 07. March 2002.

——— (2000.08.30)

'4 Sri Lankan refugees detained', Madurai edition.

——— (2000.09.07)

'Five Sri Lankan youths held', Madurai edition

——— (2000.10.11)

'PMK to expand base in southern dts.' Chennai edition.

——— (2000.11.02)

'RI for Sri Lankan', Madurai edition.

——— (2000.11.12)

'Sri Lankan national held', Madurai edition.

——— (2000.11.21)

'2 Sri Lankan 'refugees' held', Madurai edition.

——— (2000.11.26)

'Posters hail Prabhakaran's birthday', Madurai edition.

——— (2001.02.07)

'Tamil Eelam's long shadow', Madurai edition.

——— (2001.02.12)

'Grand alliance' will be formed: Jayalalitha', Madurai edition.

——— (2001.02.19a)

'5 Sri Lankan militants sentenced', Madurai edition.

——— (2001.02.19b)

'Woman tonsured for failure to provide dowry', Madurai edition.

——— (2001.06.11)

'Cong., Left legitimising corruption: BJP', Electronic edition <http://www.hindu.com/thehindu/2001/06/11/stories/0411223d.htm> - accessed 19. November 2004.

——— (2002.07.03)

'TNLA, TNRT banned under POTA', Electronic Edition <http://www.hinduonnet.com/thehindu/2002/07/03/stories/2002070306740102.htm>.

——— (2002.07.12)

'Vaiko held under POTA, taken to Madurai', Electronic edition <http://www.thehindu.com/2002/07/12/stories/2002071205410100.htm> - accessed 26. November 2003.

——— (2002.12.07)

'NGO rehabilitates dowry victim', Electronic edition <http://www.thehindu.com/2002/12/07/stories/2002120704320500.htm> - accessed 18. November 2003.

TIMES OF INDIA (2000.05.14)

'No way refugees can come here: naval officer', Bangalore edition.

ADDITIONAL ELECTRONIC SOURCES

DMK - Dravidar Munnetra Kazhagam (2004.11.12)

'DMK - The Sri Lankan Tamils'. <http://www.thedmk.org/histmain.html>. - Accessed: 12. November 2004.

OFERR - Organisation for Eelam Refugees Rehabilitation (2002.02.25)

<http://www.oferr.org/heading.html>. - Accessed: 25. February 2002.

MHA - Ministry of Home Affairs, Government of India (2002.03.01)

'Annual Report, Chapter XIV - Rehabilitation of Displaced Persons'.

<http://mha.nic.in/ch14.html>. - Accessed: 01. March 2002.

——— - Ministry of Home Affairs, Government of India (2003.05.30)

'Annual Report, Chapter XIV - Rehabilitation of Displaced Persons'.

<http://mha.nic.in/annual%20report-X14.htm>. - Accessed: 30. March 2003.

——— - Ministry of Home Affairs, Government of India (2004.02.16)

'Annual Report, Chapter XIV - Rehabilitation of Displaced Persons'.

<http://mha.nic.in/AR01CHP14.htm>. - Accessed: 16. February 2004.

http://www.lib.utexas.edu/maps/middle_east_and_asia/india_rel01.jpg

http://www.lib.utexas.edu/maps/middle_east_and_asia/sri_lanka_pol01.jpg

<http://www.unveilindia.com/Pictures/maps/TamilNadu.jpg>

<http://www.censusindia.com>

<http://www.ambedkar.org>