

# Distribution and genesis of tills in central south Norway

KARI GARNES AND OLE FREDRIK BERGERSEN

BOREAS



Garnes, Kari & Bergersen, O. F. 1977 06 01: Distribution and genesis of tills in central South Norway. *Boreas*, Vol. 6, pp. 135-147. Oslo. ISSN 0300-9483.

The morphogenesis of tills below the culmination zones of the Weichselian inland ice has been studied in an upland area with a relief of 1500 m. The thickness of the tills varies considerably, depending principally on geomorphology, ice-movement directions, and glaciofluvial drainage during the last deglaciation period. The thickest tills, found in valleys, accumulated in three ways. Glaciofluvial/lacustrine sediments of presumed Mid-Weichselian age have been discovered beneath the tills at more than 10 localities. The overlying tills are correlated with different phases of ice movement reconstructed on the basis of detailed studies of striae. The till stratigraphy of one locality, Stenseng, is described in detail. Based upon combined analyses of texture, structure, and fabric, four different basal tills are recognized, each corresponding to a particular ice direction. A characteristic boulder layer represents a change in the direction of glacial movement. Boulder layers in till are thought to be essential for the development of earth pillars.

*Kari Garnes and Ole Fredrik Bergersen, Geological Institute, Dept. B, University of Bergen, Olaf Ryesvei 19, N-5014 Bergen, Norway, 16th August, 1976.*

Little has been published to date on the morphogenesis of Norwegian tills. This is especially true of tills in the central parts of South Norway, in ice-shed zones of the Weichsel ice sheet. In Norway it has been the custom only to distinguish between two genetic types of till, namely ground moraine and ablation moraine. Further descriptive classification is based on grain size, during mapping for example (Follestad 1973). It has only been shown quite recently that basal tills (ground moraines) are often clearly stratified (Bergersen & Garnes 1972; Garnes 1973).

It has commonly been accepted that Norwegian tills were mainly deposited during deglaciation. Discoveries of sub-till sediments and the establishment of a till stratigraphy show that this is incorrect. Most of the tills of central South Norway are now presumed to have been deposited during earlier phases of the last ice age.

Our research was conducted in a mountain and valley landscape of central South Norway with a relief of 1500 m (Fig. 1). The investigations brought to light a number of sub-till glacial lake sediments and proglacial deposits

from a Mid-Weichselian interstadial, known as the Gudbrandsdalen Interstadial (Bergersen & Garnes 1971). These discoveries have led to a re-appraisal of the course of events during the last ice age in South Norway. Studies of landforms and till stratigraphy have also confirmed that ice erosion was only moderate during Weichsel II. Ubiquitous evidence of ice erosion, therefore, must predominantly be derived from earlier glaciations.  $C^{14}$  dating of mammoth remains from the investigated area has given the following results (Heintz 1974):  $24,400 \pm 980$  years BP (a tusk in sub-till sediments),  $19,000 \pm 900$  (a tusk in sediments of uncertain genesis),  $22,370 \pm 980$  and  $20,000 \pm 250$  (a tusk in deglaciation sediments),  $46,000 \pm 2,000$  and  $45,400 \pm 1,500$  (scapula in till).

The wide distribution of sub-till sediments shows that considerable parts of South Norway were ice free during at least one, and possibly several periods of the Mid-Weichsel. Research already in progress on these sediments is expected to help resolve several debated Quaternary problems in Scandinavia. The purpose of the present paper is, however, to discuss the morphogenesis of the overlying tills.

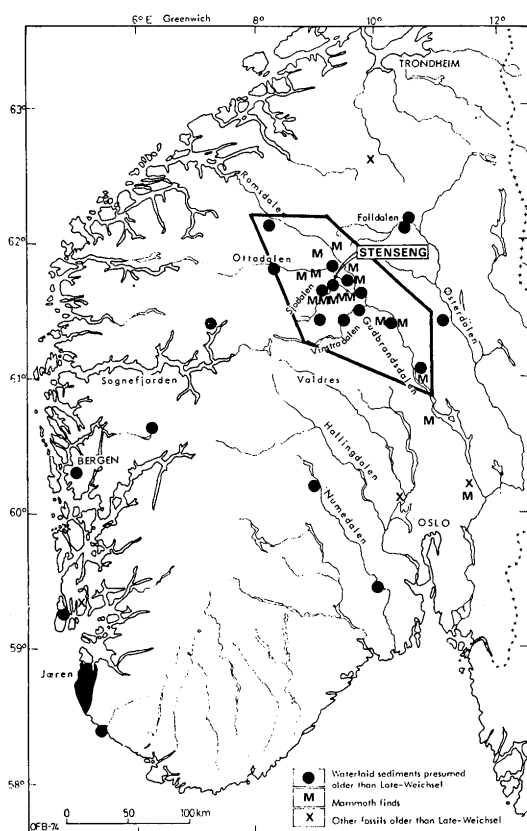

Fig. 1. Localities with sediments and fossils presumed older than Late-Weichsel. The investigated area is framed.

### Some general characteristics

The distribution and thickness of the tills vary greatly from valley-fills more than 50 m thick to large areas with no drift whatsoever. Relief, ice movements, and melt-water erosion during deglaciation are the most important controlling factors of the distribution. Bedrock type is of little importance to till thickness, as there appears to be no significant difference between quartzite, schistose sandstone and gabbro, which are the most extensive country rocks. The greatest variations, both as regards thickness and type of till, occur in the valleys. The deep tributary valley fills are particularly significant. There, the till lies asymmetrically in relation to the valley profiles due to the orientation of the valleys relative to movement directions of the depositing ice sheet. The mode of accumulation of three types of valley-fill is

shown schematically on Fig. 2. It is important to note that ice moving obliquely to the 300–400 m deep tributary valleys began accumulating till high on the valley sides, and not in the valley bottoms.

The composition of the till is partly dependent upon parent material and its transport history. Material transport occurred mainly along the valleys, especially the main ones; and most tills, therefore, have a far higher content of material transported over long distances than do tills in interfluvial areas. The tills along the valleys often had a very high content of older (glacio-)fluvial sediments which have been incorporated in the drift. Such till has among other things been termed 'Sedimentmoräne' (Korpela 1969:79) and 'allokton morene' (Bergersen 1964:58–61). The stoney content of these tills is always more rounded than in normal till (Fig. 3), and the grain-size distribution is occasionally abnormal where the till is derived from underlying sediments.

Tills lining the valleys generally exhibit the highest fractions of fine material. A content of 6–12% clay of less than 2 microns is usual. Otherwise, the tills are poor in clay, 0–3% being most common.

Grain-size distribution analyses of different till types showed several interesting characteristics. The relationship between median value ( $Md = Q_{50}$ ) and the coefficient of sorting ( $So = \log Q_{75}/Q_{25}$ ) is presented here. Fig. 4 shows the distribution of 538 analyses of different types of till plotted on an  $Md/So$  diagram, simplified according to Selmer-Olsen (1954), and by an outline diagram. A difference in  $Md/So$ -values appear between tills in the valleys and tills on the interfluvial highlands (Fig. 5).

### Till stratigraphy at Stenseng

In order to illustrate till stratigraphy of the type established, and the basis for it, a locality at Stenseng in the Lower Sjoa valley will be described here. The locality is situated at c. 600 m a.s.l. in a valley that emerges from Norway's highest mountains, not far from recent glaciers. The relief of the valley is polycyclic, and young fluvial generations are represented by 200 m deep meander incisions in a wide, mature valley floor. In a few

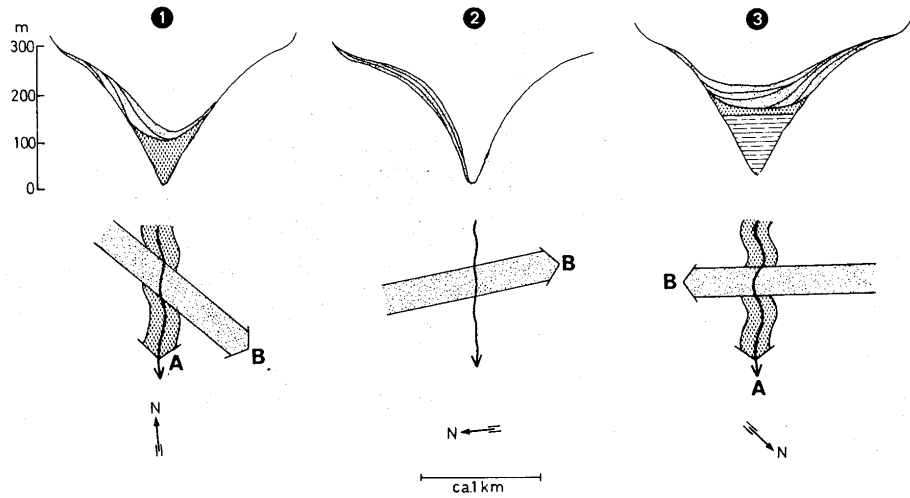
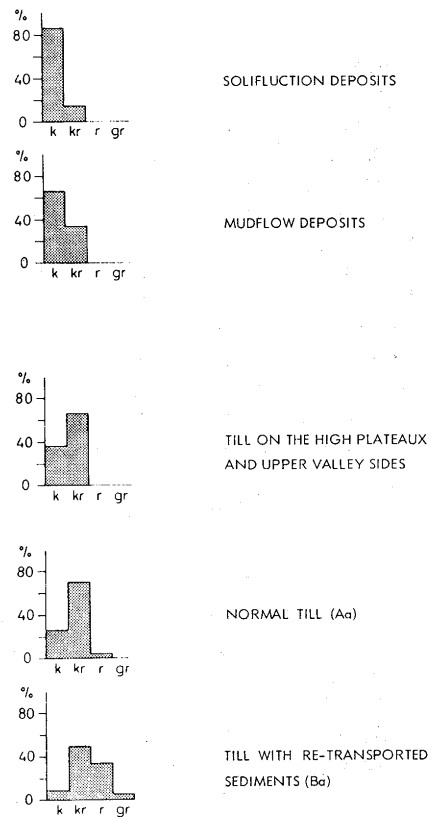

Fig. 2. Mode of accumulation of thick basal tills in tributary valleys in the Lower Gudbrandsdal valley. Type 1 shows a lower basal till deposited by a glacier flowing out the valley (phase A on Fig. 7). The upper till is accumulated by glaciers flowing obliquely across the valley (phase B). The accumulation first started as a lee-side moraine on the upper part of the valley side, just below the well-marked valley shoulder. Veikle valley is a typical example. Type 2 lacks the valley-glacier phase, the large tills belonging to phase B only. The accumulation did not reach the valley bottom. Example: Tromsa valley. Type 3 corresponds to type 1, but here the valley bottom contained thick waterlaid sediments when the deposition of tills started. Due to these old sediments, and also because of glacier flow directly across the valley, the accumulation during phase B reached the opposite valley side. Example: Skåbu in Vinstra valley.

Fig. 3. Roundness of stones in different till types. The average morphograms show the results of 122 analyses of till in the Gudbrandsdal area (after Bergersen 1973). The four classes of roundness are angular (k), abraded angles (kr), rounded (r), and well rounded (gr).



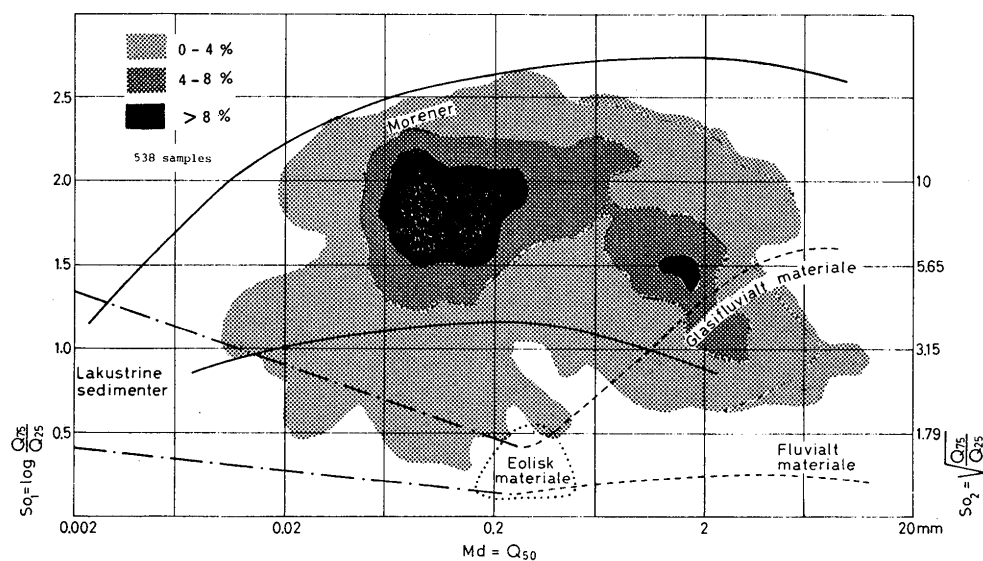

Fig. 4. A Md/So-diagram, simplified after Selmer-Olsen (1954), with an outline diagram based on 538 grain-size distribution analyses of <19 mm material from tills in the investigated area. The left maximum on the figure represents basal tills, the right one ablation tills. The latter expands into the glaciofluvial area. The well-sorted fine-grained samples resembling lacustrine and eolian sediments occur as lenses in basal tills.

meanders, sediments have been preserved despite intense glacio-fluvial erosion during deglaciation. These sediments are now being undercut by the Sjoa river (Fig. 6).

The Lower Sjoa valley lies in the middle of that area (Figs. 1 and 7) for which we have reconstructed the events of the last ice age (Weichsel II?). This reconstruction is primarily based on detailed analysis of striae, but other things such as texture, structure, and stratigraphy of tills, and geomorphology were also investigated. The illustration (Fig. 7), which is now undergoing revision before being presented in a more refined form, shows 4 main phases. An important factor governing the distribution of superficial material in central South Norway is the location of ice-shed zones over 100 km south of the main water shed. As shown in the figure, this was the case during both phases C and D. During phases B and C, and in part D also, the ice movements appear to have been little influenced by topography. Striations in valley bottoms indicate ice movements across main valleys with a relief of 600 m. This indicates that the ice sheet over the valleys was 2,000 m or more in thickness (Aseev 1968). It

was only late in phase D that geomorphological conditions again began to exercise control over ice movements.

### Stratigraphy

In the Stenseng gully section (Fig. 8) we have distinguished 5 different tills on the basis of textural and structural analyses (B, C, D, E, and F). Beneath the till lies a c. 50 m thick glacio-lacustrine deposit, (G), covered by recent slump material, (A), from the till. Immediately above the lake sediments there is a gravelly till, F (Fig. 9). The boundary between the two deposits is heavily disturbed; and a thick wedge of till apparently forced c. 1 m down into the underlying silt sediments is probably a true 'till wedge' (Dreimanis 1969). Its form and direction indicate this (Fig. 10). The till next to the lowest till has a visibly higher content of fine material and exhibits zones with noticeably different boulder contents upwards in the section. Fissility is clearly visible over most of the face (Fig. 11). Till B comprises ablation till and glacio-fluvial deposits from deglaciation (Fig. 12).

Fig. 5. Md/So outline diagram of tills – mostly basal till – in narrow tributary valleys (A), in main valleys (B), and in interfluvial areas (C). The classes are 0–4%, 4–8%, and >8% per 1% area. The diagrams show that tills in the tributary valleys are very poorly sorted, with coefficients of sorting nearly constant compared with tills occupying the main valleys. Both the median value and the coefficient of sorting show large variations in tills in interfluvial areas, probably due to the difficulty of distinguishing basal till from ablation till. In valleys, the corresponding ablation material is better sorted and is therefore classified as glaciofluvial material.

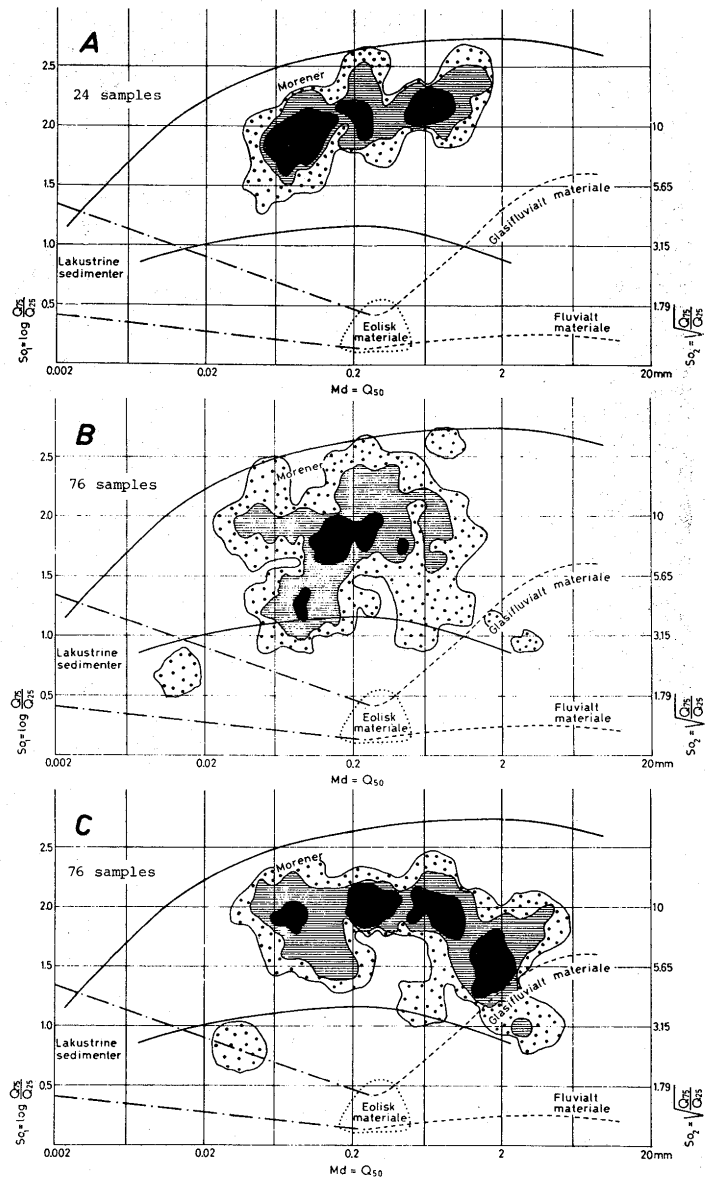

### Stone counts

There are clearly considerable lithological differences in the section, but it is uncommonly difficult to classify the rocks. Much effort was expended in attempting to reach an adequate classification, but the diffuse transitions between rock types render class boundaries imprecise. The stone counts, however, show a clear lithological boundary at the boulder layer, D, in the upper part of the exposure (Fig. 8).

At least 50% of the rocks in this layer and below consist of local quartz-schist, while samples of overlying material contain less than 25% of these rocks. Instead, the proportion of typical Jotun rocks (excluding gabbro-schist) increases, and it constitutes c. 25% of the stone fraction in the ablation till. These rocks, which are typical of most of Jotunheimen, probably come from the south-to-west sector and have been transported over a relatively long distance. The lithological boundary at the

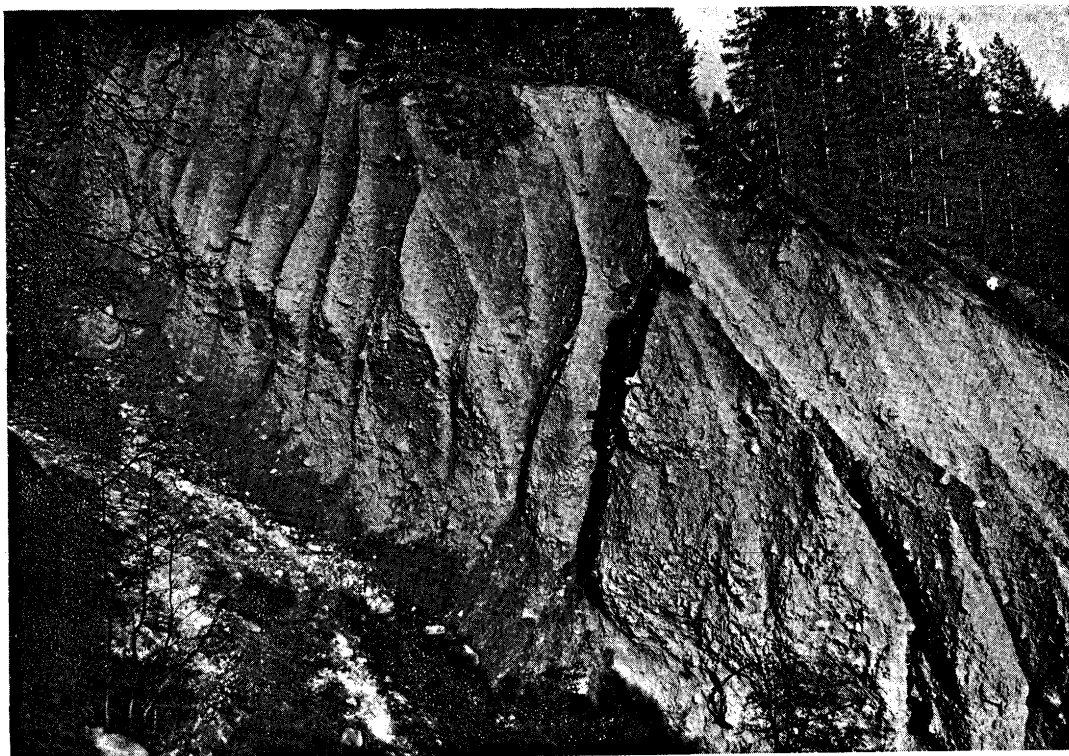

Fig. 6. The Stenseng gully in Lower Sjoa valley (view towards the northeast). The boulder pavement in the upper part of the exposure represents the surface of the thick underlying till deposited by glaciers flowing towards the southeast. The overlying tills are found to be accumulated by glaciers flowing towards the east and towards the northeast respectively.

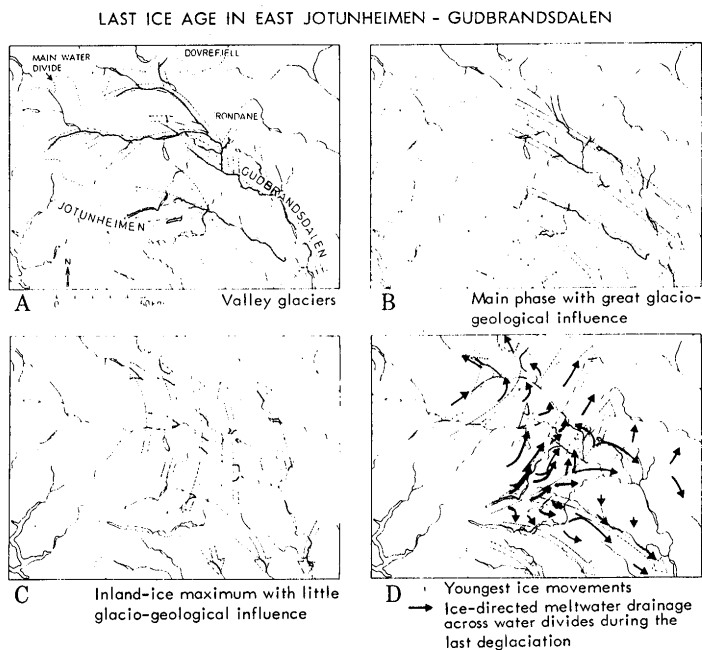

Fig. 7. A reconstruction of 4 phases of ice movements during the last ice age (after Garnes 1975).

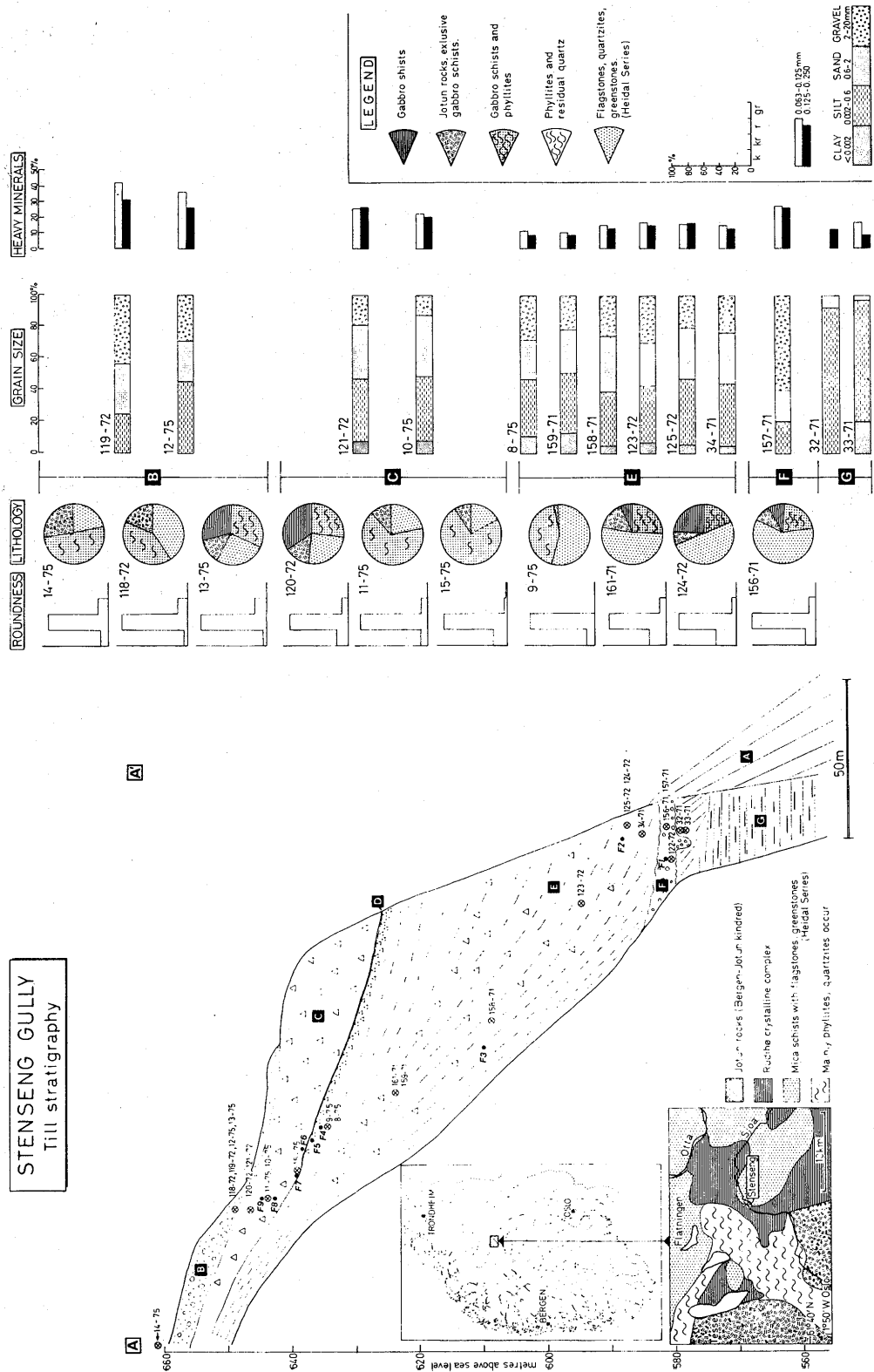
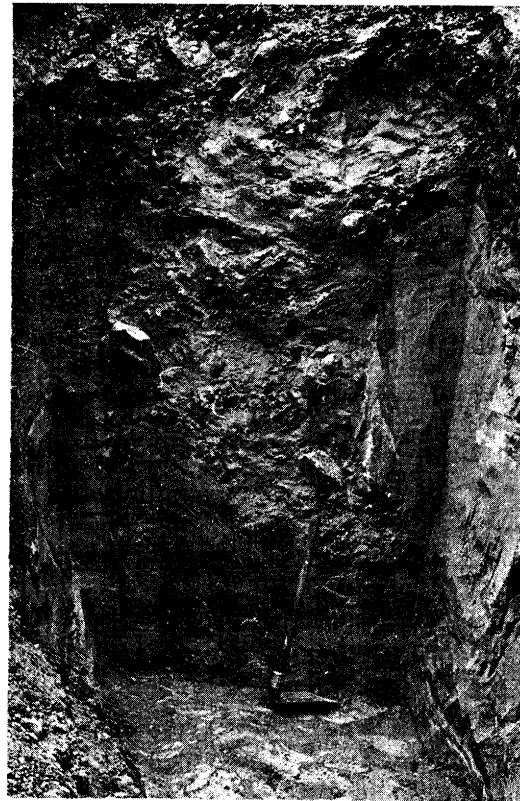

Fig. 8. Compound diagram showing the results of stone counts, roundness analyses, grain-size distribution, and heavy mineral analyses in the Stenseng gully. The rock type classification is simplified after Strand (1951). Roundness classes are angular (k), abraded angles (kr), rounded (r), and well rounded (gr). The section shows the stratigraphy with sample localities plotted. The results of the fabric analyses are shown on Fig. 14.



*Fig. 9.* The lower gravelly till, F, at Stenseng, viewed at about 1 m above the surface of the glacier-lake sediments, G. The till lacks the finest fractions. Clear structures are not to be seen. Till resting on sorted sediments is often found to be of this type.



*Fig. 10.* A wedge of till injected into the underlying glacier-lake sediments. The wedge seems to have a crescentic shape pointing to the southeast. Till-fabric analysis (Fig. 14, F 1) indicates that the till was deposited by glaciers flowing in the same direction. The section is aligned approximately east-west and the view is towards the north.

boulder layer is fully compatible with an alteration in ice movement from northwest to southwest.

#### *Roundness*

Analyses of roundness were made for all stone samples. The results show small variations in the individual tills. All the morphograms fall within the usual limits for tills in Central Norway (see Fig. 3). The small variations are, however, significant. Ablation till, B, has more rounded and less angular material than the basal tills, C, D, and E. The lowest till, F, has a distinct element of polycyclic, rounded material.

#### *Grain-size distribution*

Grain-size distribution analyses of presumably representative samples show very small varia-

tions in basal tills, C and E. The content of fine material, especially clay of less than 2 microns, increases upwards in the section, and in the upper half, it accounts for approximately 10% of material less than 20 mm in size. The lowest till, F, and the upper till, B, are distinct from the typical basal tills in that they are dominated by gravel and lack clay.

#### *Heavy minerals*

Heavy mineral separation gave results conforming with those of the stone counts. There is a particularly noticeable increase in heavy mineral content above the boulder layer already mentioned: while the heavy mineral content is mainly 10–15% below the layer, it is



*Fig. 11.* A typical picture of till E viewed towards the east. The till shows fissility with a relatively steep dip to the southeast. Exfoliation speeds the work of denudation.

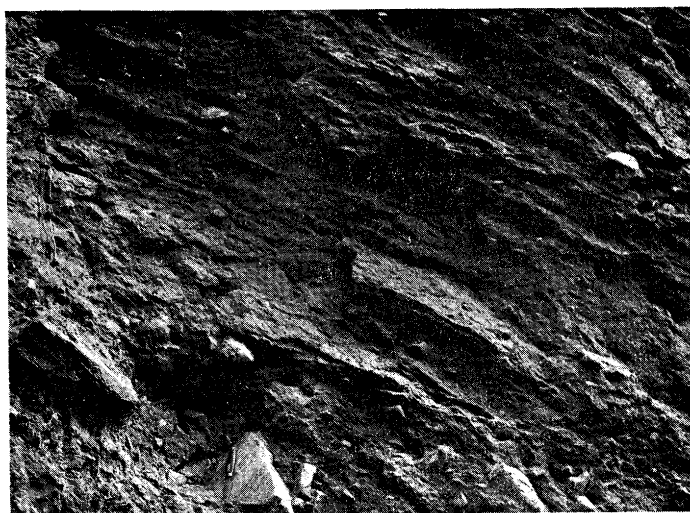

20–40% higher up. Till F deviates by having a content of c. 25%. This can, however, be explained by the till having incorporated in itself material which had been conveyed along the valley from the southwest.

Heavy mineral identification was carried out by microscopy for 4 samples, and it showed that the content of amphibole, epidote, and pyroxene is considerably higher in samples with a large heavy mineral percentage than in the remainder (Fig. 13). This is presumably due to large supplies of material from areas with crystalline Jotun rocks, i.e. from south to west.

#### *Till fabric*

Fabric analyses were carried out in 12 places (Fig. 14). This was time consuming, but gave most interesting results. The analyses were made in section facettes with various orientations. Most measurements were taken in a vertical plane, but some were made in the horizontal. The majority of fragments measured belonged to the stone fraction. Their dip was also measured, and the results were recorded to the nearest 5°. Fragments with a greater dip than c. 30° were ignored, although this represented a source of error. However, the uncertainty associated with the horizontal projection of fragments with such a steep dip is high.

Fabric analysis has proved to be an excellent



*Fig. 12.* The uppermost stoney till, B, which is interpreted as an ablation till. The material is coarse and the content of far-transported, often rounded particles is higher than in the basal tills.

method in stratigraphical investigations of tills. Orientation is good in all the present analyses, and the results agree well with the striations of the area. Not only do the results from the

## HEAVY MINERAL IDENTIFICATION

Sample no.	157-71		158-71		159-71		121-72	
	Mineral grain	%	Mineral grain	%	Mineral grain	%	Mineral grain	%
Pyroxene	52	4.57	63	3.05	20	0.69	59	4.92
Amphibole	69	6.06	53	2.57	67	2.31	102	8.50
Epidote	73	6.41	61	2.96	21	0.72	63	5.25
Mica	31	2.72	38	1.84	55	1.90	20	1.67
Tourmalin	2	0.18	2	0.10			5	0.42
Garnet			11	0.53	10	0.34	3	0.25
Apatite	1	0.09	4	0.19			4	0.33
Zirkone	3	0.26					1	0.08
Titanite	3	0.26	5	0.40			9	0.75
Opaque	61	5.36	45	2.18	64	2.21	30	2.50
Alterite	5	0.44	18	0.87	57	1.96	4	0.33
Sum	300	26.36	300	14.54	294	10.13	300	25.01

*Fig. 13.* Heavy mineral identification in 4 till samples at Stenseng. The total percentage of heavy minerals in each sample is found by separation (specific gravity 2.82) and is therefore a weight-percent. The percentage of each mineral, however, is the product of the total weight-percent and the number of grains of the mineral. As seen from the sample data, there is a strong correlation between a high, total, heavy mineral percentage and a high content of pyroxene, amphibole and epidote, i.e. minerals derived from basic, Jotun, crystalline rocks.

Stenseng gully verify the striation directions, but also our interpretations of their relative ages. As in other tributary valleys of Gudbrandsdalen, the thick basal tills in the Lower Sjoa valley were accumulated by ice moving toward the southeast. Most of the till in the Stenseng gully can be correlated with such movement (see fabric analyses F 2-5 and F 10 in Fig. 14 and Fig. 8). The transition to till deposited by other ice movements is marked by a zone of boulders. Comparable zones are usual in many larger till sections and often indicate an alteration in ice-movement direction. They seem also to be a necessary condition for the formation of earth pillars which are well developed in several tributary valleys of Gudbrandsdalen.

Fragments immediately above the boulder zone at Stenseng are orientated toward the

east, but only in a very thin layer, c. 0.5 m (Fig. 14, F 6). This direction is already apparent in the upper part of the boulder zone (F 5). The orientation higher up in the section is clearly northeasterly (Fig. 14, F 7-9 and F 11-12). The easterly orientation coincides exactly with the ice-movement direction determined by striation analysis (Fig. 15), and it is possible, even though unproven by material analyses, that this ice movement deposited its own basal till, D. The northeasterly orientation can be correlated with those ice-movement directions that persisted until the area was deglaciated (Fig. 7, phase D).

*Fig. 14.* The Stenseng gully with all fabric analyses plotted. The contour intervals are 3% per 1% area. Each fabric analysis represents about 100 measurements. The slope of the valley side is also plotted.

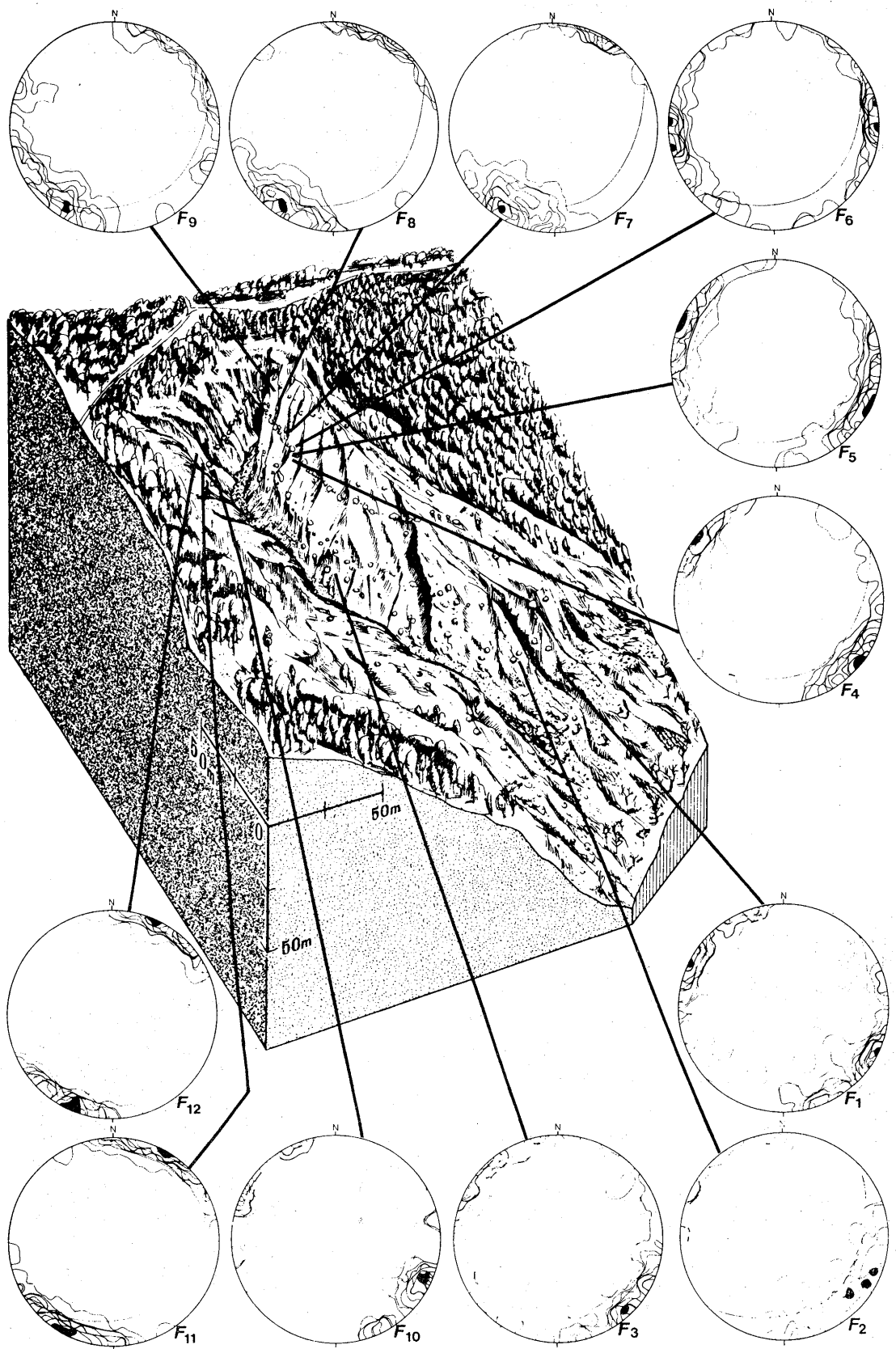

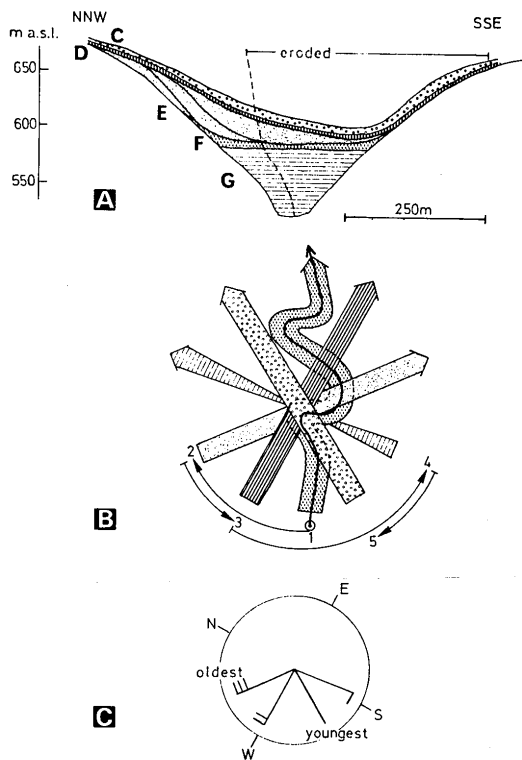

Fig. 15. Genetic interpretation of the basal tills at Stenseng.

- (A) The presumed deposition of the tills seen in a cross profile oriented NNW-SSE. Most of the tills and the glacio-lacustrine sediments also, are eroded.
- (B) Reconstructed glacier streams as found by combined analyses. Deposition from phase 4 is lacking and the phase is determined from numerous striae only.
- (C) The interpretation of the nearest locality with striae that could be found. It lies about 2 km west of Stenseng.



Fig. 16. A large lateral moraine in Grøndalen on Dovrefjell, viewed from the south. The view on the photograph is forshortened, but the moraine is 3 km long and more than 20 m high. The ridge is thought to have been deposited due to shifting of meltwater drainage to a lower pass. The ice lay to the left of the moraine on the photograph.

### Dip measurements

Dip measurements showed that the fragments were mainly deposited horizontally or dipping slightly against the direction of flow in relation to the surface on which they were deposited. In the case of till deposits on valley sides, it is important to consider the slope of the underlying surface; whereas the dip of fragments decreases upwards in till E with that of the surface of deposition, it increases again in till C because the direction of ice movement is now towards the northeast and the valley side (stoss side). Dip measurements are therefore important in order to decide the directions of those ice movements that orientated the fragments. This is not always easy to determine in areas with diametrically opposite ice-movement directions.

### Correlation with ice movements

The tills of central South Norway have a clear stratigraphy which can be correlated with different ice movements. Most of the material was deposited during early phases of the last glaciation, particularly during phase B on Fig. 7. In certain areas, such as Stenseng, there are also considerable deposits from phase D. The northerly ice movements presumed to represent the maximum of Weichsel II are not represented by any deposit at Stenseng. The genesis and development of the tills in the Stenseng locality are shown schematically on Fig. 15.

### The ablation tills

Deglaciation in the area under consideration was effected primarily by vertical wasting. The last remains of the ice sheet lay therefore in the main valleys. During melting, there was considerable supra-glacial and lateral melt-water drainage. This followed distinct routes determined by ice-surface gradients and the positions of overflow passes. Large accumulations of *ablation till* and *glacio-fluvial material* often line these routes. Ablation till is other-

wise absent over large areas, indicating that the central parts of the ice sheet were very clean before the great mountain areas melted out. Locally, the ice-surface gradient became steeper as melt-water drainage shifted to a lower pass, and this often caused the accumulation of large lateral moraines (Fig. 16). This material is usually distinct from basal tills owing to its high content of boulders and stones and low content of fine material.

### REFERENCES

- Aseev, A. A. 1968: Dynamik und geomorphologische Wirkung der europäischen Eisschilde. *Petermanns Geogr. Mitt.* 112, 112–115.
- Bergersen, O. F. 1964: Løsmateriale og isavsmeltning i nedre Gudbrandsdalen og Gausdal. *Nor. geol. Unders.* 228, 12–83.
- Bergersen, O. F. 1973: The roundness analysis of stones. A neglected aid in till studies. *Bull. Geol. Inst. Univ. Upps.* 5, 69–79.
- Bergersen, O. F. & Garnes, K. 1971: Evidence of sub-till sediments from a Weichselian interstadial in the Gudbrandsdalen valley, Central East Norway. *Nor. geogr. Tidsskr.* 25, 99–108.
- Bergersen, O. F. & Garnes, K. 1972: Ice movements and till stratigraphy in the Gudbrandsdal area. Preliminary results. *Nor. geogr. Tidsskr.* 26, 1–16.
- Dreimanis, A. 1969: Till wedges as indicators of direction of glacial movement. *Abstracts with Program, Geol. Soc. America, Annual Meeting, Atlantic City, 1969*, 52–53.
- Follestad, B. A. 1973: Løten. Beskrivelse til kvartærgeologisk kart 1916 I–M 1:50,000. *Nor. geol. Unders.* 296, 1–41.
- Garnes, K. 1973: Till studies in the Gudbrandsdal area, Eastern Central Norway. *Bull. Geol. Inst. Univ. Upps.* 5, 81–92.
- Garnes, K. 1975: Øst-Jotunheimen. Beskrivelse og vurdering av de geomorfologiske og kvartærgeologiske forhold for "Landsplan for naturområder/forekomster". *Report, Geological institute, University of Bergen*. 25 pp.
- Heintz, A. 1974: Two new finds and two new age-determinations of mammoths from Norway. *Nor. geol. Tidsskr.* 54, 203–205.
- Korpela, K. 1969: Die Weichsel-Eiszeit und ihr Interstadial in Peräpohjola im Licht von submoränen Sedimenten. *Ann. Acad. Scient. Fenn. A III* 99, 1–108.
- Selmer-Olsen, R. 1954: Om norske jordarters variasjon i korngradering og plastisitet. *Nor. geol. Unders.* 186, 102 pp.
- Strand, T. 1951: The Sel and Vågå map areas. *Nor. geol. Unders.* 178, 117 pp.

