

Papers and Monographs from the Norwegian Institute at Athens
Volume 4

TEGEA II

INVESTIGATIONS IN THE SANCTUARY OF ATHENA ALEA 1990–94 AND 2004

Authors:

Hege Bakke-Alisøy, Anne E. Bjune, Nicolas Drocourt, Jonas Eiring,
Håkon Ingvaldsen, Anne Ingvarsson-Sundström, Mario Iozzo, Harald Klempe,
Knut Krzywinski, Jean-Marc Luce, Margharet Nicolardi, Anette Overland,
Jari Pakkanen, Siri Sande, Chiara Tarditi, Mary E. Voyatzis,
Knut Ødegård, Erik Østby

General Editor:

Erik Østby

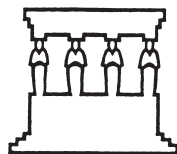

The Norwegian Institute at Athens
Athens 2014

Jari Pakkanen: OBSERVATIONS ON THE RECONSTRUCTION OF THE LATE CLASSICAL TEMPLE OF ATHENA ALEA

Several new blocks of the Classical temple of Athena Alea at Tegea were brought to light during the Norwegian excavations in 1990–94, and a number of them can be used to introduce new ideas regarding the reconstruction of the temple. The main purpose of this chapter is to publish these blocks and to evaluate their contribution to the reconstruction of the building, which was, according to Pausanias, “far superior to all other temples in the Peloponnese”.¹ The most important revision argued here concerns the appearance of the doorways of the temple: at least one of the entranceways belongs to a rare category in Classical architecture where the lintel block is supported by pilasters with capitals. Two of the excavated blocks, a large fragment of a door lintel and a column drum, are also significant for studying 4th-century building technology. The method of clamping the wall blocks to the lintel is unusual, if not unique, and the drum with preserved marble pieces for an arris repair provides a clear insight into the precision of craftsmanship displayed throughout the building.

I will first briefly present the most important previous studies related to the topic and summarize the results which have already been published from the block inventory that was carried out as part of the recent fieldwork at the site.² I will also comment on some of my earlier conclusions. Before starting the detailed discussions of the new blocks and their role in revising the reconstruction of the temple, I will give a short synopsis of the current understanding of the architecture of the building. The final section presents a more thorough analysis of some aspects related to the appearance of the doorways and the reconstruction of the cella interior. The preliminary catalogue of the building blocks in the sanctuary is also published in this volume (section **xix**).

Previous investigations

In 1806 E. Dodwell first recognized the partially buried architectural remains in the village of Piali³ as those of the temple of Athena Alea described by Pausanias in the 2nd

century A.D. Based on a misinterpretation of this source, Dodwell describes the temple as being composed of three superimposed storeys, as follows: “above the Doric was the Corinthian, surmounted by the Ionic”.⁴ The confusion is created by the passage in the ancient text describing where the Ionic columns were located: Pausanias writes that the columns were outside (ἐκτός), but some scholars have wished to emend it to inside (ἐντός).⁵ I will return to the issue later in this text. Following Pausanias, Dodwell also slightly exaggerates the size of the temple: Pausanias describes it as the finest and largest in the Peloponnese, and Dodwell compares the size of the Doric columns to those of the Parthenon even though the difference in size is substantial.⁶

Archaeological research in the sanctuary started in 1879, when A. Milchhöfer from the German Archaeological Institute at Athens excavated test trenches in order to establish the precise location of the temple.⁷ G. Treu first proposed that the sculptures in the local museum of Piali should be identified as fragments of the pedimental group; he attributed them to Skopas of Paros, who is named as the architect of the temple by Pausanias.⁸ F. Adler, R. Borrmann, W. Dörpfeld, P. Graef, and F. Graeber made further observations on the architectural fragments at Piali and agreed that the

⁴ ὁ μὲν δὴ πρῶτος ἐστὶν αὐτῷ Δώριος, ὁ δὲ ἐπὶ τούτῳ Κορίνθιος: ἐστήκασιν δὲ καὶ ἐκτός τοῦ ναοῦ κίονες ἐργασίας τῆς Ἰωνῶν. Paus. 8.45.5; Dodwell 1819, 418–9.

⁵ Most editions keep the original manuscript text, but the emendation has been accepted *e.g.* by H. Hitzig and H. Blümner, *Des Pausanias Beschreibung von Griechenland*, vol. III, Leipzig 1907, 97 (commentary, 285), and in the latest Teubner edition (*Pausaniae Graeciae Descriptio*, vol. II, ed. M.H. Rocha-Pereira, Leipzig 1977, 319). For recent discussions of the passage, see the comments by N.E. Papachatzis, *Πανσάνιον Ἑλλάδος περιήγησις, Βιβλία 7 καὶ 8, Ἀρχαϊκὰ καὶ Ἀρχαδικὰ*, Athens 1980, 390 n. 3 and 506 n. 7; Norman, *Temple*, 179; Pakkanen 1996, 153–7.

⁶ Paus. 8.45.5; Dodwell 1819, 418. There are actually several larger temples in the Peloponnese (Østby *et al.*, *Report*, 89 n. 2). The lower diameter of the Parthenon drums is 1.905 m (Dinsmoor 1950, 338), and at Tegea ca. 1.55 m (Pakkanen, *Temple*, 22–3, and below, p. 355).

⁷ Milchhöfer, *Untersuchungsausgrabungen*.

⁸ Paus. 8.45.5; G. Treu, “Fragmente aus den tegeatischen Giebelgruppen des Skopas,” *AM* 6, 1881, 393–423. For Skopas as the architect of the temple, see section **xvi** (Østby), 346–8.

¹ Paus. 8.45.5; translation by W.H.S. Jones (Loeb edition).

² Pakkanen, *Temple*.

³ Dodwell 1819, 418–9. The village has now been renamed Alea.

previous scholars had correctly identified the site as the temple of Athena Alea.⁹ A more systematic study of the temple foundations was then carried out in 1882 by Dörpfeld; by also incorporating the remains excavated by Milchhöfer, he was able to publish a rather detailed plan of the building.¹⁰ The site was taken over by the French School at Athens in 1900, when they bought most of the private plots located on the temple foundations, and over the next two years G. Mendel cleared the temple site almost completely.¹¹ The last remaining house on the south-west part of the temple was purchased by the Archaeological Society of Athens and the plot was excavated by K.A. Rhomaios in 1909.¹²

Mendel's and Rhomaios' work was continued in 1910 by a French team led by Ch. Dugas. He worked at the site until 1913, and his principal collaborators were the Danish architect M. Clemmensen and the sculptor J. Berchmans. Their main aim was to publish the excavated material, but they also conducted some further archaeological work which was mainly connected with the altar.¹³ Largely because of the First World War, the publication of their monograph was delayed until 1924, but their interpretations have been the basis of all later scholarship concerning the temple architecture. The relationship between Dugas and Clemmensen does not seem to have been entirely without difficulties; for example, even though Dugas stressed that there were no doubts regarding the height of the reconstructed column, Clemmensen questioned this in an article published just one year after the monograph.¹⁴

Clemmensen had already remarked on the stylistic similarities between the temples at Tegea and Nemea, so it was quite understandable that B.H. Hill looked for comparative material in the French publication and visited Tegea several times while he worked on the reconstruction of the Nemea temple in 1946–54. With the exception of a new reconstruction of the interior Corinthian half-column capital, Hill did not publish his results, but N.J. Norman had access to Hill's notes for her research.¹⁵ H. Bauer has later suggested a slightly taller reconstruction of the capital, but otherwise he accepts Hill's proposal as correct.¹⁶

The temple site at Tegea was cleared in 1964 and 1965 by Ch. Christou and A. Demakopoulou from the Greek Archaeological Service; they also carried out some small-scale excavations 200 m south of the temple and discovered new sculptural and architectural fragments originating from the temple.¹⁷ Further archaeological work was conducted in 1976 and 1977 by G. Steinhauer when he excavated a series of trenches in the open area north of the temple.¹⁸

A.F. Stewart's monograph on Skopas is the most complete discussion on the architectural sculpture from Tegea.¹⁹ However, O. Palagia has recently argued that according to Pausanias' description of the temple Skopas should only be identified as the architect of the temple and not necessarily also as the sculptor responsible for the pedimental groups; based on literary and stylistic evidence she suggests that they are the work of a local Peloponnesian workshop.²⁰

During the 1980s several important studies relating to Archaic and Classical temples were published. A weighty article by H. Knell presents a general survey of Late Classical and Hellenistic Doric peripteral temples, but he also discusses the Tegea building in some detail: he suggests that the ratio 6 : 14, reflecting the number of columns on the facade and sides of the temple, could also be recognized at the euthyteria level, and that the normal interaxial distance between the columns at the front of the temple was incorrectly calculated by Dugas and Clemmensen.²¹ Neither of these hypotheses should be accepted, as I have demonstrated elsewhere.²² Secondly, Norman studied the temple for her dissertation and published the principal points as an article: Dugas and Clemmensen had reconstructed Corinthian half-columns only on the side walls of the cella, but she proposes that the colonnade continued across the rear wall, and that there were two superimposed orders, following the parallel at Nemea, with the Corinthian order below and an Ionic one above.²³ Thirdly, based on the dimensions of the front elevation, H. Bankel has attempted to define the foot-standard used at Tegea.²⁴ Finally, E. Østby has presented a detailed study of the foundations inside the

⁹ Dörpfeld 1883, 274.

¹⁰ Dörpfeld, 1883, 275–7.

¹¹ G. Mendel, "Fouilles de Tégée," *BCH* 25, 1901, 241–56; Dugas *et al.*, *Tégée*, x.

¹² K.A. Rhomaios, "Ἀνασκαφαὶ τοῦ ναοῦ τῆς Ἀλέας," *Prakt* 1909, 303–16.

¹³ Ch. Dugas, "Les fouilles de Tégée," *CRAI* 1911, 257–8; Dugas *et al.*, *Tégée*, x–xii.

¹⁴ Dugas *et al.*, *Tégée*, 18; M. Clemmensen, "Le temple de Zeus à Némée," *BCH* 49, 1925, 11–2.

¹⁵ Hill 1966, pl. 29.B; Norman, *Temple*, 169 and n. 1. I consulted Hill's papers at the American School of Classical Studies at Athens in 1994 and could confirm that Norman had observed all the substantial points made by Hill. I wish to express my gratitude to W. Coulson, former director of the School, for permission to study the papers, and to C. Zerner for practical assistance.

¹⁶ H. Bauer, *Korinthische Kapitelle des 4. und 3. Jahrhunderts v.Chr.*

(*AM-BH* 3), Berlin 1973, 65–71 and 142. See section xv (Østby), 330–2 with *Fig. 8*, for a discussion of the Corinthian capital.

¹⁷ Ch. Christou and A. Demakopoulou, "Ἐργασίαι εἰν χώρον ναοῦ Ἀλέας Ἀθηνῶς ἐν Τεγείᾳ," *ArchDelt* 20.2.1, 1965, Χρον., 169–70; A. Demakopoulou, "Ἀνασκαφὴ εἰν Τεγείᾳ," *ArchDelt* 21.2.1, 1966, Χρον., 152–4.

¹⁸ Østby *et al.*, *Report*, 96. This excavation remains unpublished, but some information is given by Voyatzis, *Sanctuary*, 21 and 24–5; see also the introduction to this volume (Østby), 1 with note 4.

¹⁹ A.F. Stewart, *Skopas of Paros*, Park Ridge 1977, 5–84.

²⁰ O. Palagia, "Two sculptors named Scopas," *Newsletter, American School of Classical Studies at Athens* 35, 1995, 4.

²¹ H. Knell, "Dorische Ringhallentempel in spät- und nachklassischer Zeit," *Jdl* 98, 1983, 225.

²² Pakkanen, *Temple*, 7 n. 37.

²³ Norman, *Temple*, 179–80, *fig. 8*.

²⁴ Bankel 1984. For a critical discussion of Norman's and Bankel's conclusions, see below (pp. 357–8).

cella of the Classical temple, concluding that they were originally part of the Archaic temple and not Byzantine additions, as proposed by Dugas.²⁵

Recent observations arising from the building block inventory

Archaeological investigations at Tegea were continued in 1990 when the Norwegian Institute at Athens undertook a new project at the site, under the direction of E. Østby and as an international co-operation. The results of these excavations are extensively presented elsewhere in these volumes, but a synopsis of my previously published reports on the temple architecture and some minor revisions of my ideas are in place here.

The principal publication from the building block documentation²⁶ is a monograph published in 1998, concentrating on the exterior columns and on horizontal and vertical refinements of the temple.²⁷ The main results can be summarized as follows:

1. At the site there are 49 column drums which preserve the full height and the lower and upper diameters. The lower diameter of the column, measured at the arrises, is ca. 1.55 m, and between the flutes 1.45–1.46 m. The corresponding ranges at the shaft top are 1.20–1.21 m and 1.15–1.16 m. The corner columns were not thickened.²⁸

2. The peristyle columns stood in a vertical position: the height variation of the bottom drums is only sufficient to neutralize the curvature of the krepis and does not cause the shafts to incline inwards as suggested by Dugas and Clemmensen.²⁹

3. The dimensions of the capitals vary slightly from block to block, causing some variation in the calculated proportions of individual blocks. The differences are significant enough to cloud the results of a traditional proportional analysis; comparison with other 4th-century capitals does not result in a coherent picture. Therefore, the role of capital proportions in trying to establish precise dates for buildings in the Classical period should be reassessed, as proposed by J.J. Coulton.³⁰

4. A restudy of the horizontal curvatures shows that the slightly convex shape of the foundations

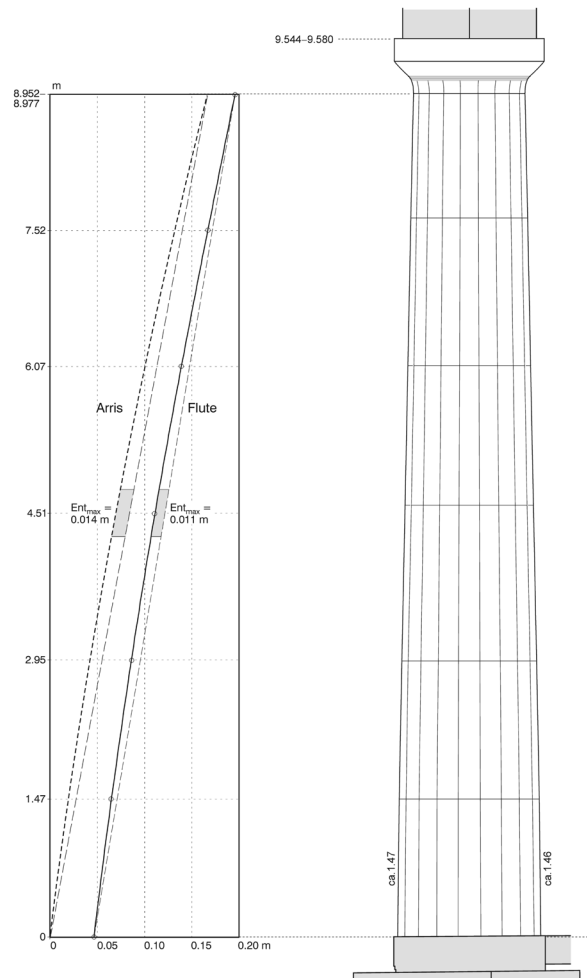

Figure 1. Reconstruction of the peristasis column in the temple at Tegea, with the entasis. (Drawing: Pakkanen 1999)

was very likely matched at the stylobate level and also in the entablature; nine of the twelve sufficiently preserved architrave and frieze blocks show signs of adjustment for horizontal curvature, and the range of angle measurements is 89.7–90.8°. The centre of the south flank of the foundations is 0.080 m higher than the south-east corner, and the western short side has a difference of 0.054 m between the corner and the centre.³¹

5. Based on computer-intensive statistics the height of the peristyle column can be established as 9.544–9.580 m which is 0.070–0.106 m higher than the French reconstruction of 9.474 m; it is not possible to establish a millimetre-exact height of the column with the currently preserved material.³²

²⁵ Dugas *et al.*, *Tégée*, 11–3; Østby 1986; and his contribution to *Tegea I* (section **i**), 35–50. Norman also observed (*Temple*, 171) that the foundations are Archaic rather than Byzantine.

²⁶ For an account of the preliminary catalogue of building blocks and progress of the work, see Pakkanen, *Temple*, 3–4, and the introduction to the block catalogue in section **xix**, 377–8. Some blocks have recently been moved to a new shelter south of the temple, with full use of the preliminary catalogue.

²⁷ Pakkanen, *Temple*.

²⁸ Pakkanen, *Temple*, 11–30. The suggestion by Dinsmoor 1950, 339, that the corner columns were enlarged has recently been followed by Bankel 1984, 423 n. 3.

²⁹ Dugas *et al.*, *Tégée*, 19; Pakkanen, *Temple*, 24–6.

³⁰ Pakkanen, *Temple*, 31–40; *cf.* J.J. Coulton, “Doric capitals: a proportional analysis,” *BSA* 74, 1979, 82–103.

³¹ Pakkanen, *Temple*, 41–7.

³² Pakkanen, *Temple*, 49–62; for a recent review of computer-intensive methods in archaeology, see M. Baxter, *Statistics in archaeology*. London 2003, 148–53. It includes an assessment of the Tegea analysis presented in Pakkanen, *Temple*, 53–4; the reply concerning the discrepancy of 2 mm noted by Baxter is found in Pakkanen 2004, 102 n. 22. Preliminary analyses of the column height and entasis are presented in J. Pakkanen, “The entasis of Greek Doric columns and curve fitting: A case study on the peristyle column of the temple of Athena Alea at

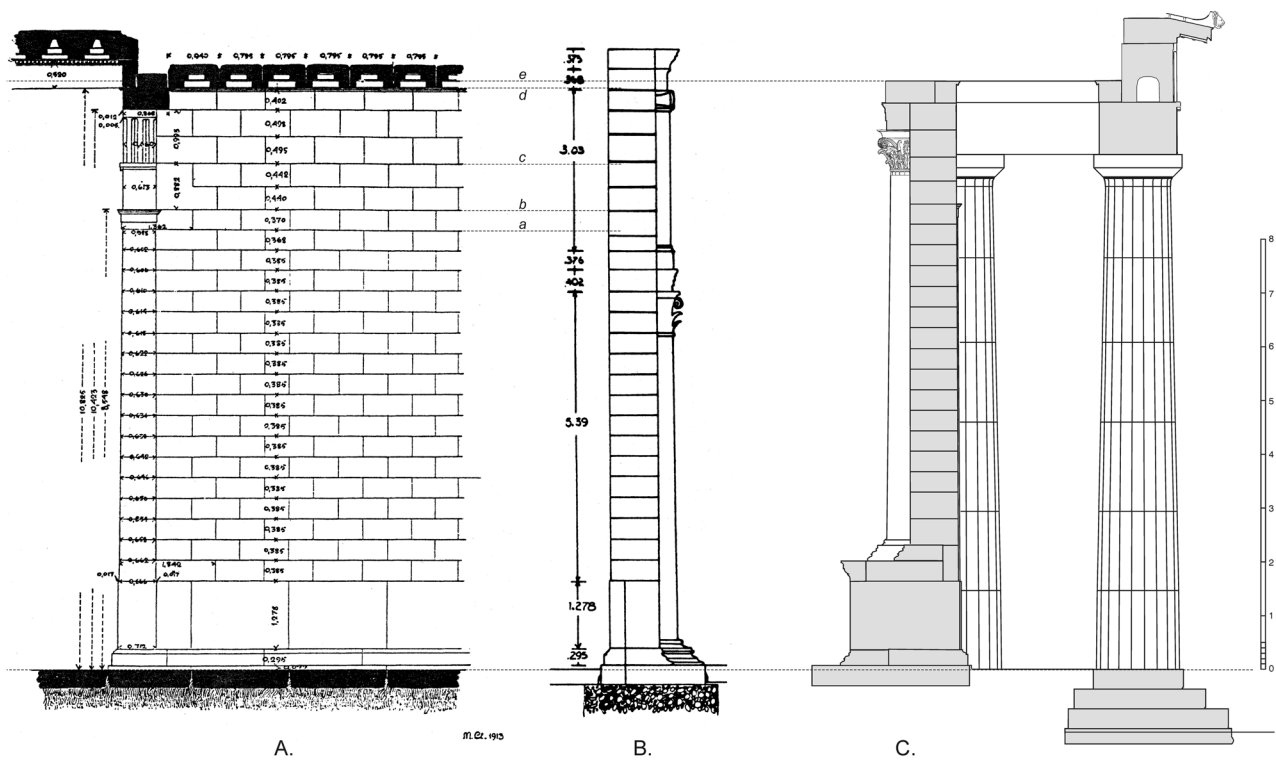

Figure 2. Different reconstructions of the interior of the temple cella. A, from Dugas *et al.*, *Tégée*, 39 fig. 14; B, after Norman, *Temple*, 177 fig. 4; C, after Pakkanen 1996, 160 fig. 8. (Drawing: Pakkanen 1999)

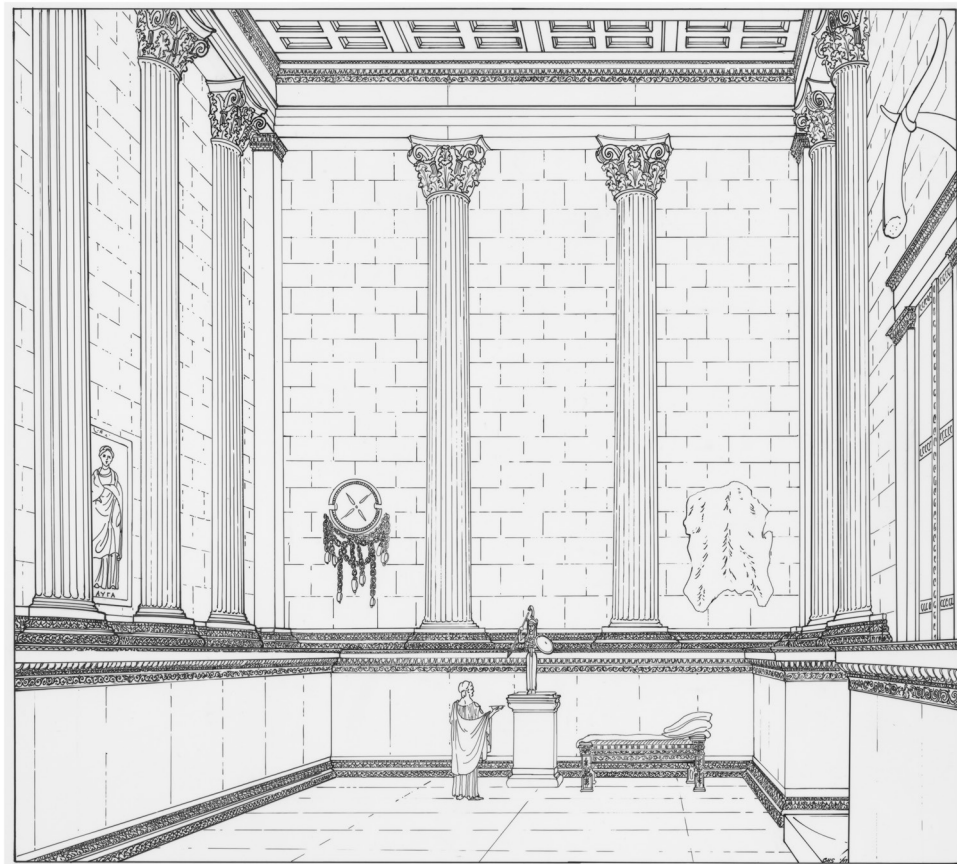

Figure 3. Perspective drawing of the interior of the temple cella, according to the reconstruction proposed by Pakkanen 1996. (Drawing C. Smith; reproduced with permission)

6. Again, based on computer-intensive analysis the maximum projection of the exterior column entasis can be determined as 11 mm; it is located approximately at half height of the shaft.³³

7. It is suggested that the entasis was designed using a simple graphic method, probably using a scale drawing and a sketched arc of a circle.³⁴

These conclusions remain valid, but I would now add the clarification that due to the condition of the relevant blocks at Tegea, the calculation of the maximum entasis had to be based on measurements taken at the bottom of the flute and not at the maximum diameter of the column, at the arris. The flute is not only narrower but also proportionally shallower at the top than at the bottom of the shaft: the difference in the proportional depth of the fluting also means that the profiles of the shaft at the arris and inside the flute are not quite identical.³⁵ The maximum entasis of the arris can be estimated as 25–30% more than the flute entasis, so the maximum projection can now be calculated as 14 mm. (*Fig. 1*)³⁶

Since the heights of the exterior order and the cella wall are linked by the coffered ceiling beams of the pteroma, a new calculation of the column height also results in rethinking how the cella wall and the interior of the building should be reconstructed. I have presented preliminary observations on the issue in an article published in 1996, but later work at the sanctuary in 1997 made me revise some aspects of this reconstruction.³⁷ I still maintain that the original reading of Pausanias' passage 8.45.5, stating that the Ionic columns were outside the temple, should be retained, and that the interior reconstruction with a podium below the Corinthian half-columns is more in agreement with the preserved archaeological material. My criticism of Norman's hypothesis of superimposed Corinthian and Ionic orders is as valid as ever,³⁸ and can be summarized as follows:

1. Her evaluation of the interior Corinthian half-columns, as they are presented in the French reconstruction, as "rather tall and slender even for a fourth century column", is based on an incorrectly calculated proportional height of 11.2 times the lower diameter;³⁹ the correct figure is 9.65 diameters, perfectly in line with the relevant comparanda. The exception is the temple of Zeus at Nemea, where the interior columns are 8.9 lower diameters high. I have suggested that these

columns were kept so low in order to accommodate the unique upper Ionic colonnade in that temple.⁴⁰

2. Norman's block arrangement breaks the intrinsic link between the exterior order and the cella interior. The epikranitis block with a hawk's beak, 0.402 m high, must reach the same level as the corresponding frieze backer at the other side of the pteron; but in her reconstruction the epikranitis course comes at the height of 10.465 m, while the frieze backer in the French reconstruction is at 10.844 m.⁴¹ Moreover, the anta blocks, 0.368 m high, correspond to wall blocks of equal height, but these blocks cannot be located above the anta capital as they are in her reconstruction.⁴²

3. The small fragment Norman attributes to the Ionic, upper order, above the Corinthian half-columns, is actually a very weathered part of a Doric, not an Ionic column.⁴³

4. Reconstructing two superimposed orders in the interior requires an emendation (from ἐκτός to ἐντός) in Pausanias' passage on the temple (8.45.5).⁴⁴

Fig. 2 presents a pictorial summary of the current state of research on the interior of the temple. There are several discrepancies between Norman's suggestion (B) and the reconstruction by Dugas and Clemmensen (A). In the latter publication the locations of some blocks are actually quite fixed: the lines *a* and *b* represent the known level of the anta capital, line *c* represents the top of the cella wall architrave, and they do not match in Norman's reconstruction. However, not even the logical French reconstruction can be allowed to stand untouched: the new column height also increases the height of the cella wall (compare lines *d* and *e*). Reconstruction C presents one possible alternative which takes into account the fixed levels of the anta capital and the cella wall entablature. This alternative is adopted by the recently produced, perspective drawing reproduced here as *Fig. 3*.⁴⁵

In a recent conference article I have proposed that the length of the basic design-unit of the temple of Athena Alea can be derived from the dimensions of the building blocks using a statistical method based on cosine quantogram analysis. It also includes a critical evaluation of Bankel's graphic metrological method and demonstrates why he fails to reach valid results based on his data from Tegea.⁴⁶ The statistical analysis supports

Tegea," *Archeologia e calcolatori* 7, 1996, 693–702; *id.*, "Entasis in the fourth century BC Doric buildings in the Peloponnese and at Delphi," *BSA* 92, 1997, 330–2.

³³ Pakkanen, *Temple*, 62–7.

³⁴ Pakkanen, *Temple*, 67–72.

³⁵ These observations were first presented in a public lecture in March 1999 at the Finnish Institute at Athens.

³⁶ For an earlier version of the drawing, see Pakkanen, *Temple*, fig. 26.

³⁷ Pakkanen 1996, 153–64; the critical observations to my first reconstruction are briefly noted in *id.*, *Temple*, 5 n. 19 (on the podium for the Corinthian half-columns) and 62 n. 32 (on the column height).

³⁸ Norman, *Temple*, 179–80; Pakkanen 1996, 154–6; *id.*, *Temple*, 5 n. 19.

³⁹ Norman, *Temple*, 176.

⁴⁰ Pakkanen 1996, 154–5.

⁴¹ Dugas *et al.*, *Tégée*, pl. 21–26; Norman, *Temple*, 174, 178–80; Pakkanen 1986, 155.

⁴² Dugas *et al.*, *Tégée*, pl. 21–26; Pakkanen 1996, 155. See also the discussion of *Fig. 2* below.

⁴³ Norman, *Temple*, 180, pl. 31.10; Pakkanen, *Temple*, 5 n. 19, pp. A27 and A42 (with a drawing); here section **xix**, 393, Block **319**. O. Palagia first observed the worn, sharp arrises in December 1997.

⁴⁴ See p. 353, note 5 above.

⁴⁵ Pakkanen 1996, 158–63 with fig. 8. The perspective drawing *Fig. 3*, based on this reconstruction, has been prepared by C. Smith for A.F. Stewart and is reproduced with her permission.

⁴⁶ J. Pakkanen, "The temple of Athena Alea at Tegea: revisiting design-unit derivation from building measurements," in E. Østby (ed.), *Ancient Arcadia* (Papers from the Norwegian Institute at Athens 8), Athens

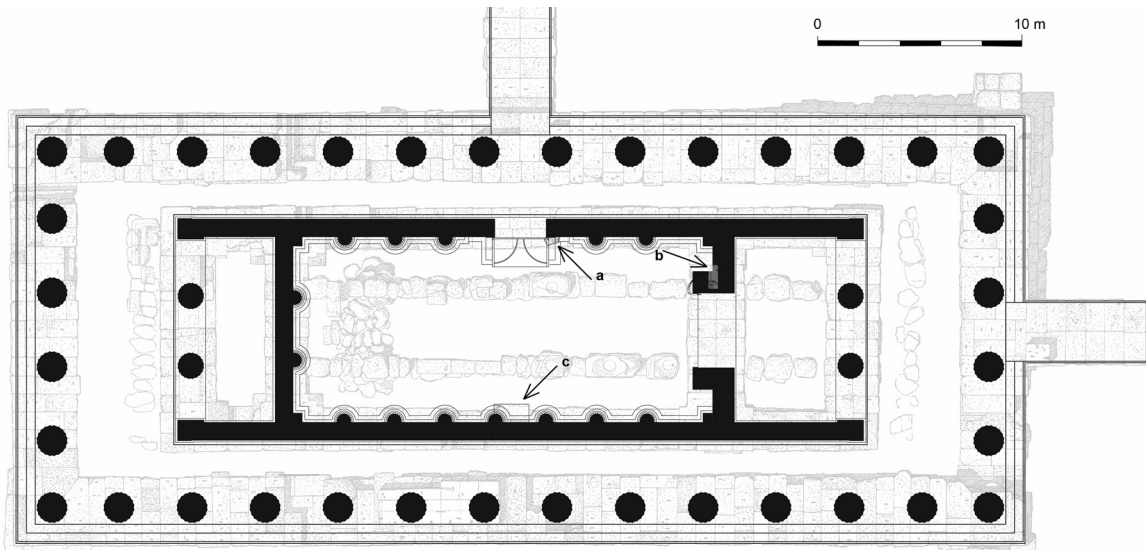

Figure 4. Reconstructed plan of the temple, with the positions of some important blocks: a, the toichobate block (Fig. 18, Block B); b, the epikranitis and toichobate blocks of the northern parastade (Fig. 18, Block A and Fig. 21.A); c, the complete block from the podium under the interior half-columns (Fig. 2.C; Dugas *et al*, *Tégée*, pl. 62.B). (Drawing: Pakkanen 2013)

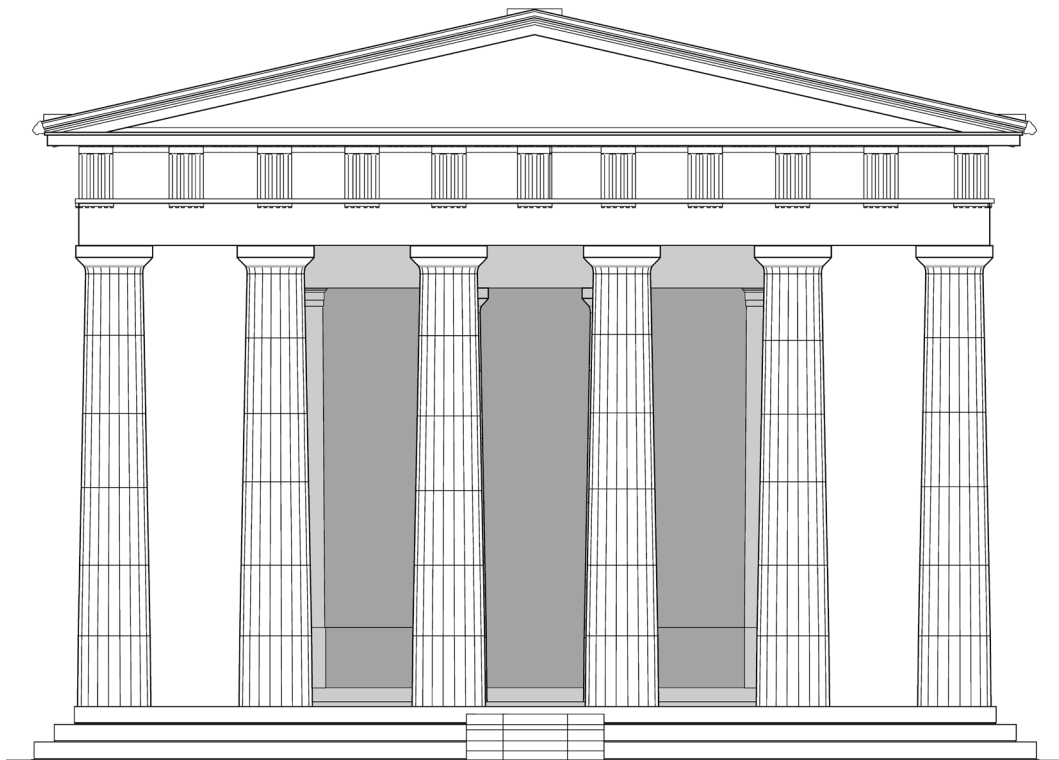

Figure 5. Reconstruction of the temple front, with the adjusted column height. (Drawing: Pakkanen 1998/2006)

the identification of a design-unit of ca. 99 mm in the temple; this unit is most probably to be understood as one third of a foot of 297–298 mm.⁴⁷ This division of the foot

into thirds supports the theory that Greek measurement units could also be subdivided into 12 parts ('thumbs' or inches) in addition to the customary 16 dactyls.⁴⁸

2005, 167–83; cf. Bankel 1984. A substantially updated analysis of the temple design, including the design-unit and the foot standard and based on new data, is now available in J. Pakkanen, *Classical Greek architectural design: A quantitative approach* (Papers and monographs of the Finnish Institute at Athens 8), Helsinki 2013, 94–109.

⁴⁷ There is a parallel in the temple of Zeus at Stratos where the design-

unit can be determined as 0.1053 m, possibly corresponding to one third of a local foot-unit of 0.316 m; Pakkanen 2004, 111–9.

⁴⁸ This position is also taken by W.B. Dinsmoor and W.B. Dinsmoor Jr., *The Propylaia to the Athenian Akropolis II: The Classical building*, Princeton 2004, 447, in connection with the Propylaia of the Athenian Akropolis; but a statistical analysis should be carried out to test their hypothesis.

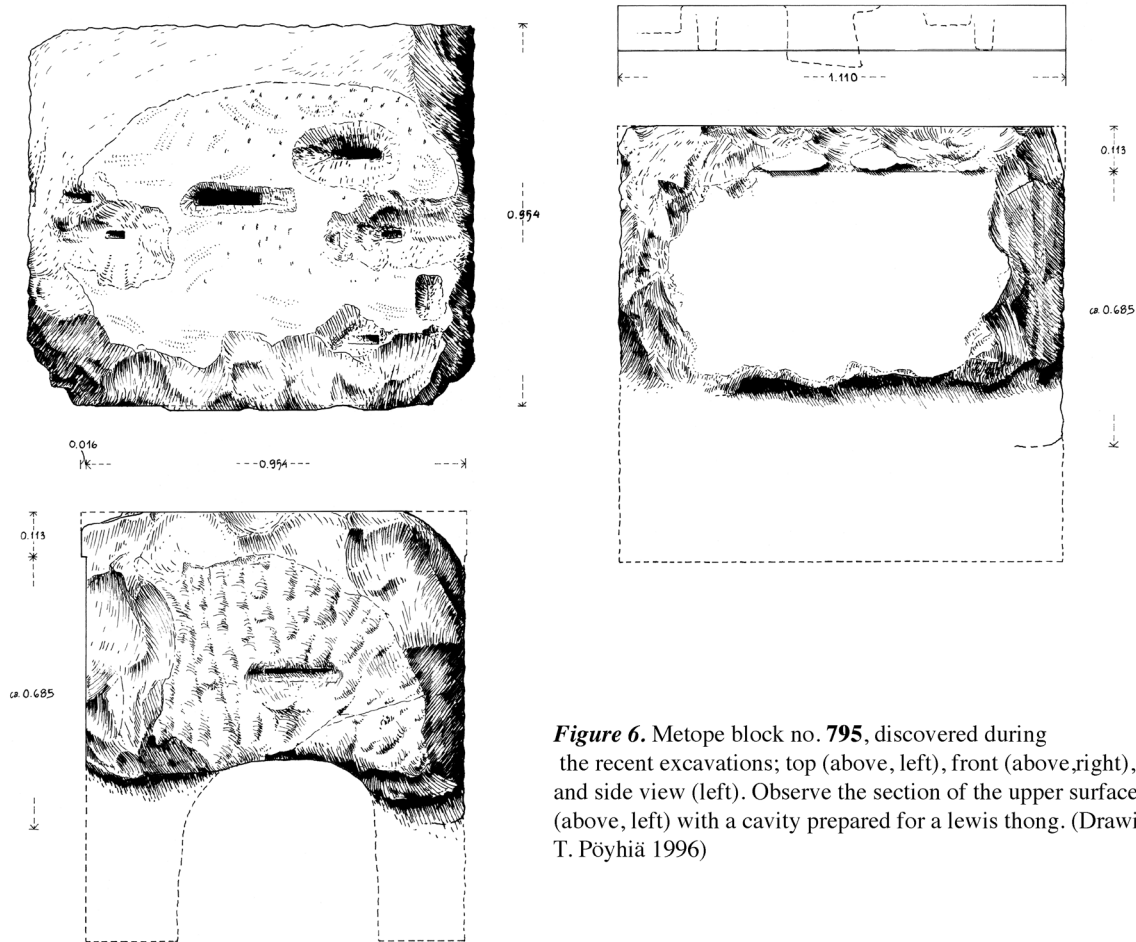

Figure 6. Metope block no. 795, discovered during the recent excavations; top (above, left), front (above, right), and side view (left). Observe the section of the upper surface (above, left) with a cavity prepared for a lewis thong. (Drawing: T. Pöyhä 1996)

The Late Classical temple of Athena Alea

The most important ancient source for the Archaic and Classical temples of Athena Alea at Tegea is the passage by Pausanias which has repeatedly been mentioned (8.45.4–5). He informs us that the old temple of Athena Alea burned down in 395/94 B.C., and that Skopas of Paros was the architect of the new one. As a result of the excavations carried out in the early 20th century, the conglomerate foundations of the Classical Doric temple and a large number of marble blocks from the superstructure were uncovered and left visible at the site. The likeliest source of the temple marble are the ancient quarries at Dolianà.⁴⁹

Foundations of an entrance ramp on the east facade are preserved, but the function of the similar projecting structure on the north flank of the building is more controversial: the stratigraphy on that side of the building suggests that it was a platform rather than an access ramp.⁵⁰ The revised temple

plan and the front elevation are presented in *Figs 4–5*. The facade reconstruction takes into consideration the new, increased column height, and I will discuss some aspects of the cella arrangement later in this study.

The plan with 6 × 14 columns is unusually elongated for a 4th-century temple, and it very likely reflects the proportions of the Archaic temple.⁵¹ The slender columns have a height of ca. 6.2 times the lower diameter,⁵² and when compared with 5th-century Doric architecture, the entablature is rather low in relation to the column height. The porches have the standard distyle-in-antis arrangement, and the cella is reconstructed with Corinthian half-columns standing on a podium. The probable date for the Late Classical temple is just after the middle of the 4th century B.C.⁵³

⁴⁹ Since the marble from the site has not been scientifically studied, this identification can be questioned; see e.g. M.P. Waelkens, P. de Paepe and L. Moens, “Patterns of extraction and production in the white marble quarries of the Mediterranean: History, present problems and prospects,” in J.C. Fant (ed.), *Ancient marble quarrying and trade* (BAR-IS 453), Oxford 1988, 90–1. However, since the Dolianà quarries are the closest known ancient quarries located only ca. 10 km south-east of Tegea, they are the likeliest source.

⁵⁰ Østby *et al.*, *Report*, 114–5; *id.*, “Recent excavations in the sanctuary of Athena Alea at Tegea – results and problems,” in R. Hägg (ed.),

Peloponnesian sanctuaries and cults (SkrAth 4^o, 48), 144–5; and *id.* in section *xvi*, 340–1. For example, it has been suggested that the north door was used for athletic processions into the cella (Norman, *Temple*, 189 n. 117). In light of the archaeological evidence, a more likely function of the structure might be to display something from inside the temple (the statue?) to the public gathered outside, as suggested by Østby.

⁵¹ See Norman, *Temple*, 172 and esp. n. 18; Østby 1986, 93–5; and *id.* in section *xvi*, 317–8, for a short discussion of the relation between the two buildings.

⁵² Pakkanen, *Temple*, 72–3.

⁵³ Norman, *Temple*, 191–3, dates the building to 345–335 B.C. See the discussion by Østby in section *xvi*, 341–6.

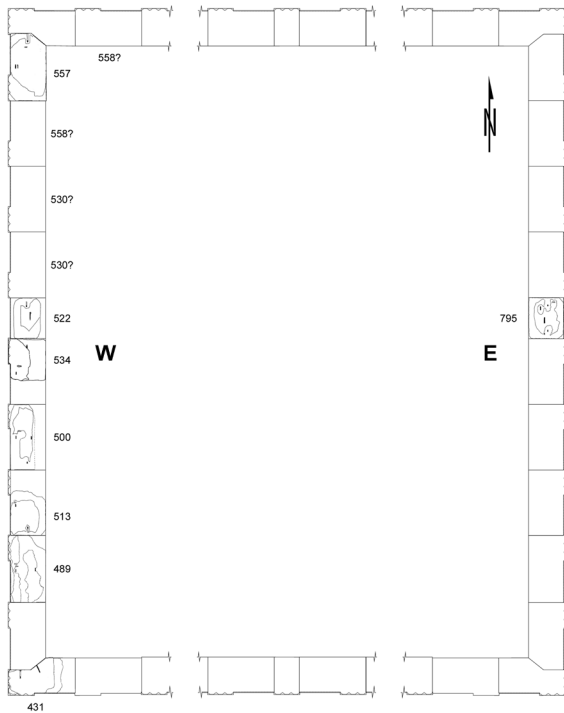

Figure 7. The presumed disposition of preserved blocks in the two front friezes. (Drawing: Pakkanen 2006)

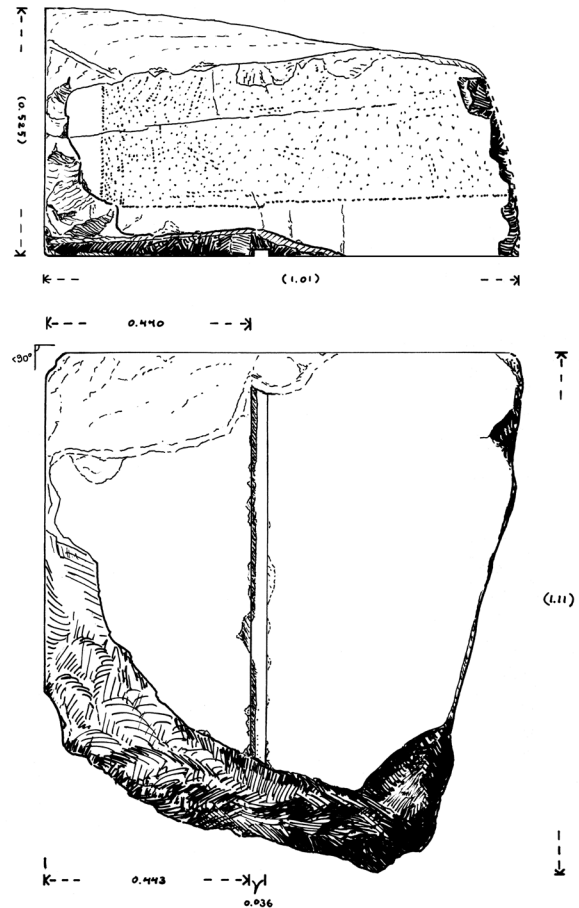

Figure 8. Block 802 from a door jamb, discovered during the recent excavations: side view (above) and top (below). (Drawing: Pakkanen 2005).

New temple blocks discovered in the recent excavations

The blocks discovered by the Norwegian excavations were documented between 1993 and 1996. Most of the site drawings and the final inked versions presented here were drafted by the architect Tuula Pöyhiä, some by the author of this paper. Only blocks which increase our knowledge of the Classical temple have been included in the following analysis.

Block 795. Metope from the exterior order Fig. 6

This block (Fig. 6) can be identified as part of the exterior order by the height and projection of its taenia and by the overall width and depth of the block, which all correspond to other metopes from the temple. Moreover, the centre of the lower half is hollowed out to make the block lighter and easier to lift, which is also typical of the normal frieze blocks.⁵⁴ The top surface has a large, centrally placed lewis hole for lifting,⁵⁵ two clamp holes

for attaching it to the neighbouring frieze blocks, and three dowel holes for fixing it to the geison blocks above; the anathyrosis rim is completely broken off on the side of the stone, and the central part of the roughly dressed side surface has a lateral cutting for easier handling of the block during lifting and positioning.

This is a new type of exterior frieze block not previously identified in the sanctuary. There are two variants of standard frieze blocks consisting of a joint triglyph and metope, and their difference is in the relationship between the two elements: in the first type the triglyph is to the left of the metope (e.g. Block 489 in Fig. 7), in the second variant the relationship is reversed (e.g. Block 530). The second, earlier recognized type is basically similar, but one corner of the block is faceted to fit into the corner frieze block next to it, and it also comes in two mirror-image variants (Block 557). The third known type is represented by the corner block with two triglyphs turning a corner with an attached metope (Block 431).⁵⁶ The single metope block slotted between two triglyphs is a new type, and its discovery has permitted the identification of a similar block among the earlier excavated material (Block 522). It is in a very

⁵⁴ Taenia height 0.113 m and projection 0.016 m; width 1.110 m, depth 0.954 m; cf. Dugas *et al.*, *Tégée*, pls 39 and 41–43.

⁵⁵ The block provides the first documented instance of a lewis in the temple.

⁵⁶ Cf. Dugas *et al.*, *Tégée*, 21–2, esp. fig. 5, and pls 39 and 41–43.

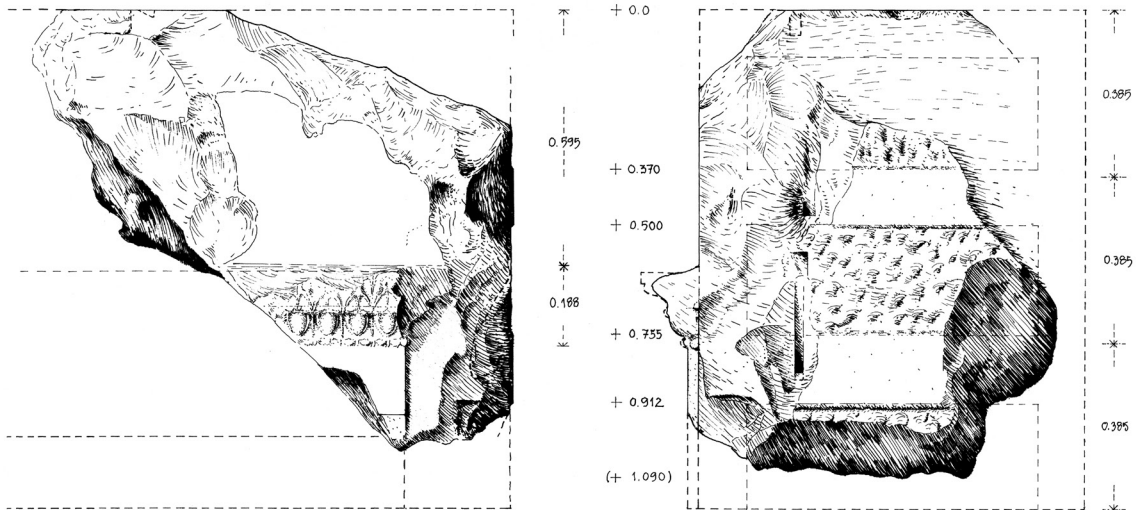

Figure 9. Block 804 from a door lintel, found during the recent excavation: front (left) and side view (right). (Drawing: T. Pöyhä 1996)



Figure 10. Mouldings on the lintel Block 804. (Photo: Pakkanen 1995)

battered condition, but the completely preserved length and the cuttings on the top surface make its classification certain. As *Fig. 7* shows, there were originally only two such metope blocks, located in the centre of the frieze on the short sides. There was a different arrangement on the flanks, where the transitional block was a single triglyph instead of a metope: no such block has been recognized in the sanctuary, but the almost completely preserved west frieze leaves few doubts regarding the general layout of the frieze.⁵⁷ The position of Block 795, as it was discovered in the recent excavations to the north of the temple, is most probably explained by the reuse

and recycling of the blocks after the destruction of the temple.⁵⁸

Blocks 802 and 804. Door jamb and lintel *Figs 8–9*

The identification of Block 802 (*Fig. 8*) as a door jamb is based on the upper left corner which is cut at a slightly acute angle, and also on the recessed band on the side which faces the exterior. The angle is consistent with the typical taper of Greek monumental doorways, and the varying distance of the band from the left side of the block demonstrates that the pilaster on the side of the door also tapered towards the top of the doorway, as expected.⁵⁹ The

⁵⁷ The positions of the blocks in *Fig. 7* are mainly based on their present location in the sanctuary, but Blocks 513 and 500 are reversed in the reconstruction (the clamp cutting at the preserved metope end of 513 has no corresponding cutting in the triglyph end of 500). No site drawings for Blocks 530 and 558 have yet been made.

⁵⁸ See for the circumstances of the discovery section iii (Luce), 49 with the photos *Figs 16–17*.

⁵⁹ The distance of the recessed band from the side surface is 0.440 m at the top of the block and 0.443 m at the preserved bottom; the preserved height of the block is 1.11 m, the width is 1.01 m and the depth is

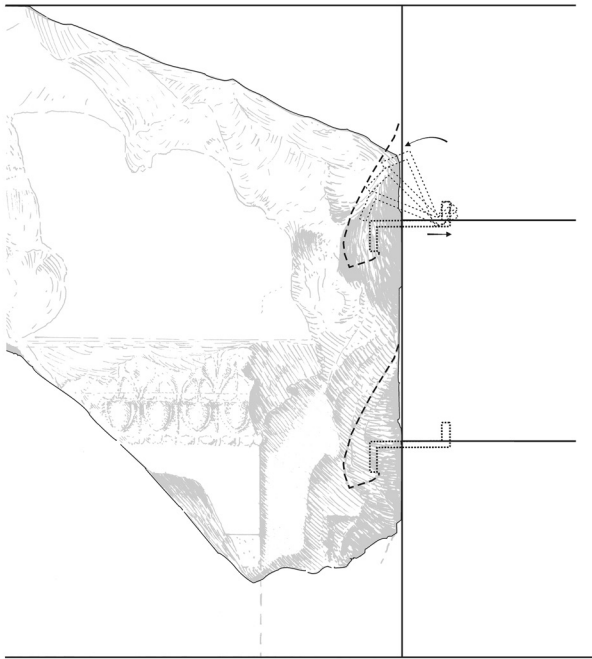

Figure 11. Clamping of the lintel Block 804. (Drawing: Pakkanen 2006)

large size of the block fits the level of the orthostate blocks of the cella wall.

Perhaps the single most important new discovery related to the Classical temple made during the recent excavations is Block 804, the large door lintel fragment. (Figs 9–11) The bottom half of the block has two projecting fasciae⁶⁰ crowned by a moulding with bead-and-reel, egg-and-dart and heart-and-dart motifs. The original full height of the block is not preserved, but based on the anathyrosis bands on the side of the block it can be reconstructed as 1.155 m corresponding to the height of three normal wall blocks. The mouldings are more suitable for the decorative interior of the temple than on the plain Doric exterior, and this conclusion is also supported by another block, the door pilaster capital, as will be demonstrated below. This block confirms Hill's hypothesis, supported by Norman, that some of the fragmentary remains previously documented by Clemmensen were part of the door lintels and not of the interior Corinthian architrave as suggested by Dugas.⁶¹

The side surface of the lintel block demonstrates an interesting technical detail. Since the block has a height of three normal wall blocks, the builders chose an unusual method of attaching it to the two lower courses of wall blocks: the two cuttings indicate that a clamp was used for

this purpose. (Fig. 11) There is another parallel in the antae of the temple where a vertical double-gamma (or Z-shaped) clamp fulfils the normal function of a dowel joining two horizontal courses of blocks together: it gives added strength to the end of the wall.⁶² This is also the probable reason for its introduction in connection with a doorway. The shape of the clamp in the reconstruction is chosen so that it gives maximum strength to the attachment: it is unlikely that a normal Π-shaped clamp would have been used, since most of the stone would have had to be cut away at the joint in order to rotate it in place. As far as I am aware, the use of a vertical Z-clamp to attach a lintel to two wall blocks is unique, so the reconstruction can only be verified by the discovery of a corresponding wall block. If pouring channels were used to fill the whole cutting with lead, they could have been located either in the lintel or in the wall block: the side surface of the lintel is not well enough preserved for any trace of them to be visible today.

The discovery of these two blocks necessitates a thorough rethinking of some other blocks that were previously linked with the doorways and the interior of the temple, so I will need to return to the issue in more detail below.

Block 808. Corner block of the pronaos frieze Figs 12–13

The identification of the block as part of the porch order is based on the relatively small size of the triglyph and on parallels with two previously discovered blocks from the pronaos and opisthodomos friezes,⁶³ though as a corner block it has no direct previous match. The two triglyphs turn the corner and the metope next to it was slotted into the rectangular cutting seen at the top of Fig. 12: the two partially preserved clamp cuttings were made in order to attach it to the next frieze block, and the large dowels on the top surface connected it to the beam spanning the pteron between the cella wall and the exterior order. The corner triglyph on the side of the long wall of the temple is separated from the surface of the wall by a 23 mm wide, recessed band. On the bottom surface there is a large, nearly square hole for the dowel that attached the block to the architrave below. There were originally two such blocks in the building, one at the north-east corner of the pronaos and the other at the south-west corner of the opisthodomos; the corresponding blocks at the two other corners of the cella were mirror images of these blocks. Its current location to the north of the temple supports the notion that this one belonged to the pronaos order. Its height is 7 mm less than the two previously identified porch frieze blocks, possibly indicating a small discrepancy in height between the pronaos and opisthodomos friezes.

The discovery of the block requires small modifications

0.525 m. The anta orthostate block of the temple of Zeus at Nemea has a recessed band (Hill 1966, pl. 20), but the shape and size of the anta at Tegea is well documented, and the distance of the recessed band in Block 802 from the side does not match the projections of the anta (the side projections of the anta at Tegea are 0.712 and 1.310 m wide at the toichobate level; Dugas *et al.*, *Tégée*, pl. 61).

⁶⁰ Just a hint of the lower fascia is preserved as can be seen in Fig. 9.

⁶¹ Dugas *et al.*, *Tégée*, 52–3, pl. 78.B–D; Norman, *Temple*, 178–9 and 187.

⁶² Dugas *et al.*, *Tégée*, 56, fig. 22. The probable reason why the vertical Z-clamp was used in the second temple of Hera at Paestum was to protect the edges of the soft stone from breakage; H.N. Fowler, J.R. Wheeler and G.P. Stevens. *A handbook of Greek archaeology*, New York, Cincinnati and Chicago 1909, 105–6, fig. 64.

⁶³ Dugas *et al.*, *Tégée*, 36–7, pl. 59.

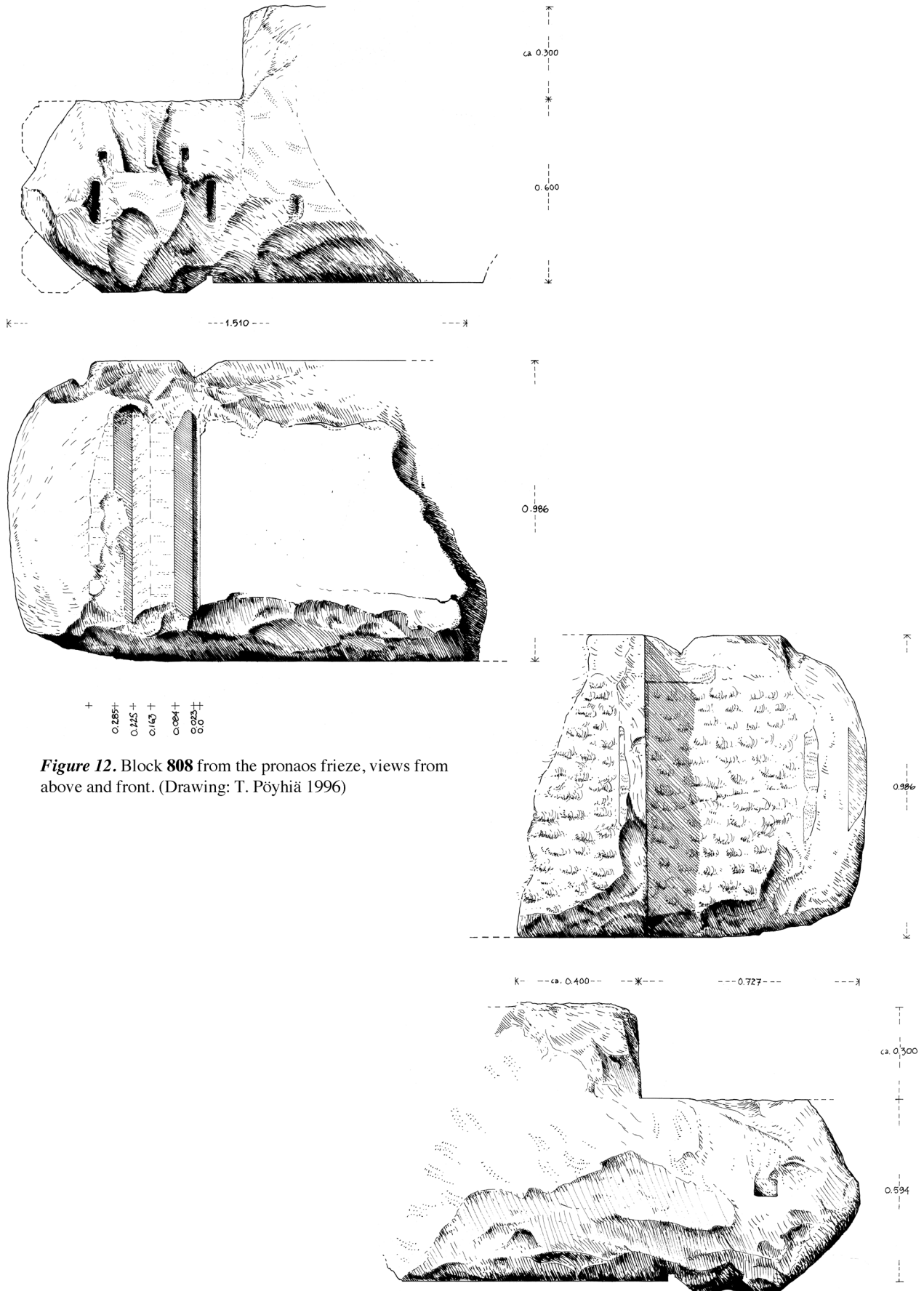

Figure 12. Block 808 from the pronaos frieze, views from above and front. (Drawing: T. Pöyhiä 1996)

Figure 13. Block 808 from the pronaos frieze, seen from behind and below. (Drawing: T. Pöyhiä 1996)

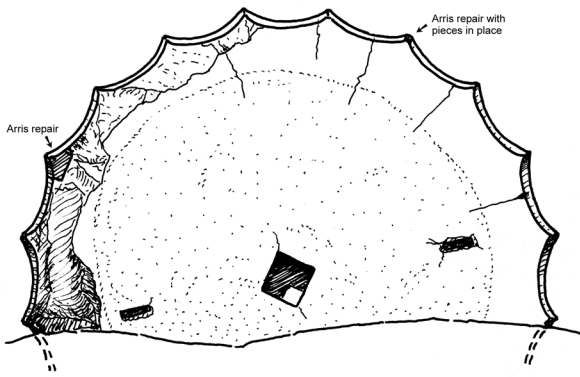

Figure 14. Top surface of the column drum 809, with indications of the repairs. (Drawing: Pakkanen 2006)

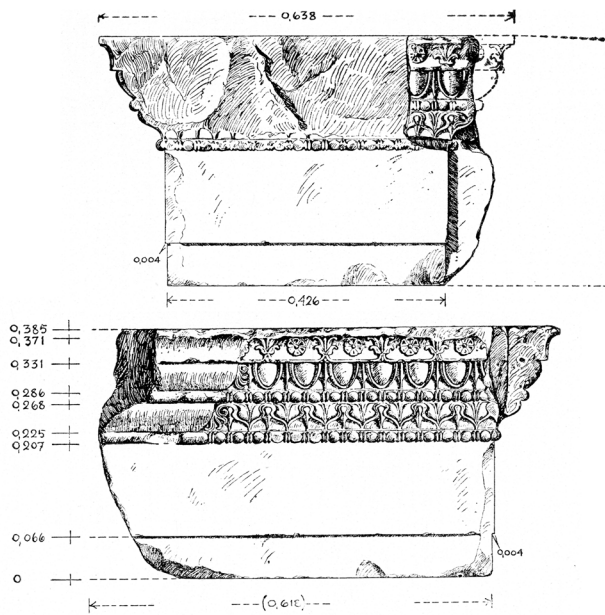

Figure 17. The capital of the door pilaster. (After Dugas *et al.*, *Tégée*, pl. 77.a–b)



Figure 15. Arriis repair on the column drum 809. (Photo: Pakkanen 1995)

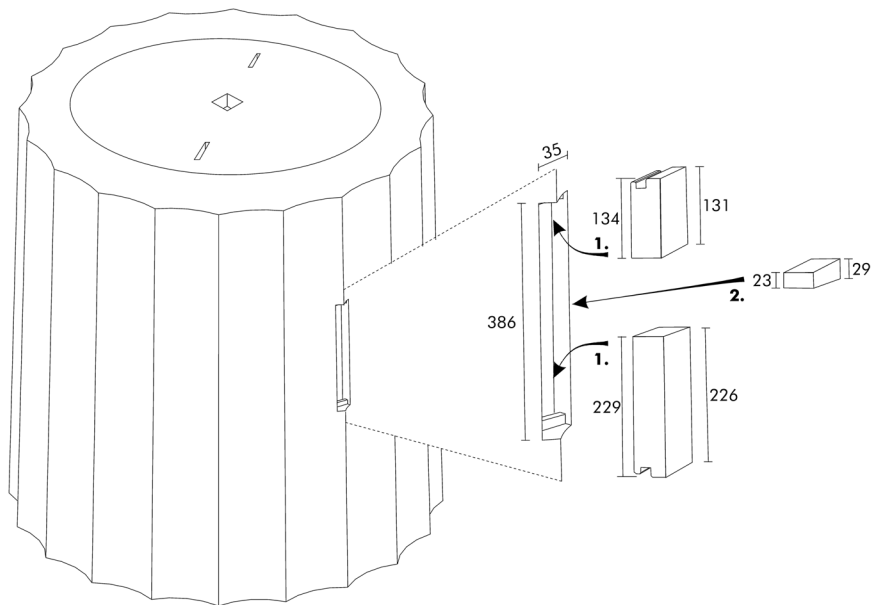

Figure 16. Suggested procedure for the repair of the arriis. Dimensions in mm. (After Pakkanen, *Temple*, 30 fig. 10)

to Dugas' and Clemmensen's reconstruction of the flank wall of the cella. (Fig. 2.A) They correctly omit the Doric frieze from the side wall, but the beginning of the wall at frieze level does not consist of two separate courses of wall blocks; instead, the corner block stretches well into the side wall. The recessed band noted above, which separates the triglyph from the rest of the wall, is also a new feature.

Block 809. Column drum with arris repair⁶⁴ Fig. 14

The drum has traces of ancient repairs to two of its arrises. The larger repair consists only of the partially preserved rectangular cutting that was made to receive the repair pieces, but the second one has most of the added marble pieces in place. The positions of the repair pieces are indicated in Fig. 14, and Fig. 15 shows the current state of the patch. The procedure of the second repair can be reconstructed based on the *in situ* remains. (Fig. 16) The broken part of the drum was tidied up by carving a rectangular surface, leaving a marble ledge in at least one end of the cutting, but very likely in both. The repair includes three pieces: the two large ones have one end pressed tightly against the ledge of the rectangular cutting, and the other end is cut obliquely to match the third, small piece between them, which wedged the two large ones in place.

It is not certain when in antiquity this repair was made, but the quality of workmanship matches the quality of the rest of the temple, so it is quite likely that it was part of the original construction process. If the broken sides of the drums were turned towards the interior of the temple, they were hardly conspicuous at all and would not have provided sufficient reason to discard a large piece of marble such as a column drum. However, it is equally likely that the slightly inferior quality of the block was only discovered when the blocks were in place and during the very final phase of the building process when the flutes were carved. The largely lost top piece indicates that no small dowels or any lead were used to attach the repairs to the drum. This method relies on exceptional workmanship in cutting the marble: even though the upper piece of the repair is largely lost, the two lower ones are still in place.

Reconstruction of the doorways

The most problematic block from the point of view of the interior reconstruction of the temple of Athena Alea has been the rectangular capital block that was previously restored to the interior corner of the cella by

⁶⁴ On the block, including dimensions, see also Pakkanen, *Temple*, 28–9, App. p. 41, figs 9–10; the latter is also reproduced in Hellmann 2002, 97 fig. 114. For general discussions of ancient repairs, see R. Martin, *Manuel d'architecture grecque I, Matériaux et techniques*, Paris 1965, 302–6; Hellmann 2002, 95–8. For tapering repairs on arrises (as on Block 7 at Tegea and probably also the second repair on Block 809), see R. Demangel, *Les temples de tuf. Le sanctuaire d'Athéna Pronaia (Marmaria)*, (FdD II), Paris 1923, 21, fig. 28; F. Courby, *Les temples d'Apollon (Délos 12)*, Paris 1931, 198; R. Vallois, *L'architecture hellénique et hellénistique à Délos jusqu'à l'éviction des déliens (166 av. J.-C.)* II.2 (BEFAR 157), Paris 1978, 507 n. 2.

Dugas and Clemmensen and entirely dissociated from the temple by Norman.⁶⁵ (Fig. 17) She argues that the block projects too strongly to be located where it is in the French reconstruction,⁶⁶ but its height of 0.385 m equals the height of a standard wall block, so it was very likely somehow connected with the cella wall. The most conspicuous feature of the block is the carefully executed transition from more decorative Ionic forms to simpler ones: the basic shape of the crowning moulding remains the same, but the undecorated part lacks the bead-and-reel, egg-and-dart, heart-and-dart, lotus-bud and rosette motifs, and a special leaf design is used in the position where the patterns change. The execution of the moulding suggests that the block penetrated the cella wall, creating a transition from the Ionic of the interior to the plainer Doric exterior. The most likely position for such a block would be as the capital of a door pilaster below the lintel block. There are two previously known parallels for door lintels carried by pilasters with capitals: the earlier case is found in the entrances of the late 5th-century temple of Apollo at Bassai, the later in the 4th-century tholos at Epidauros.⁶⁷ The three sites are geographically close to each other, and both the temple at Bassai and the tholos have other links with Tegea. Bassai and Tegea are connected by their unusual entrances in the lateral walls; in addition to the close technical similarities between the tholos and the temple of Athena Alea,⁶⁸ it is known that craftsmen from Tegea worked on the tholos.⁶⁹

A few block fragments from the toichobate course of the doorway were drawn by Clemmensen, and they indicate how the doors of one of the entranceways to the temple should be reconstructed.⁷⁰ (Fig. 18) The major dimensions in Clemmensen's plan are hypothetical, and

⁶⁵ Dugas *et al.*, *Tégée*, 50, pl. 77; Norman, *Temple*, 183–4, pl. 30.8.

⁶⁶ Norman, *Temple*, 184.

⁶⁷ Bassai: Cooper 1992, pls 19, 20.5–7, 26–33; *id.* 1996, 211–9 and 223–5. The tholos: Roux 1961, 149–50, pl. 44.3. For the date of the temple of Apollo, see Cooper 1996, 67–8, 80, 379. For the date of the tholos as 360–330 B.C., see A. Burford, *The Greek temple builders at Epidauros*, Toronto 1969, 63–4; R.A. Tomlinson, *Epidauros*, Austin 1983, 29; F. Seiler, *Die griechische Tholos*, Mainz 1986, 80–4, suggests a longer building period and a date ca. 370–320 B.C. See also the discussion in section xvi (Østby), 342–3 with note 153. The identification of the pilaster capital in Fig. 17 as part of the doorway at Tegea raises questions regarding the reconstruction proposed by Roux 1961, pl. 44.3, of a very fragmentary decorative pilaster capital on the exterior of the tholos at Epidauros: based on the parallel from Tegea it is likely that the capital is a feature of the Corinthian interior rather than of the more restrained Doric exterior.

⁶⁸ A large range of parallels is noted by Roux 1961, 184. However, since the use of a lewis to lift blocks at Tegea has now been documented on Block 795, the absence of this device can no longer be counted among them.

⁶⁹ IG IV² 103.54; for recent discussions of the inscription, see A. Burford, "Notes on the Epidaurian building inscriptions," *BSA* 61, 1966, 275–81; M.-C. Hellmann, *Choix d'inscriptions architecturales grecques* (Travaux de la Maison de l'Orient Méditerranéen 30), Lyon 1999, 77–80. Connections between the buildings at Bassai, Epidauros and Tegea are extensively discussed in section xvi (Østby).

⁷⁰ Dugas *et al.*, *Tégée*, 43–4, pl. 63; the fragments are now unfortunately lost.

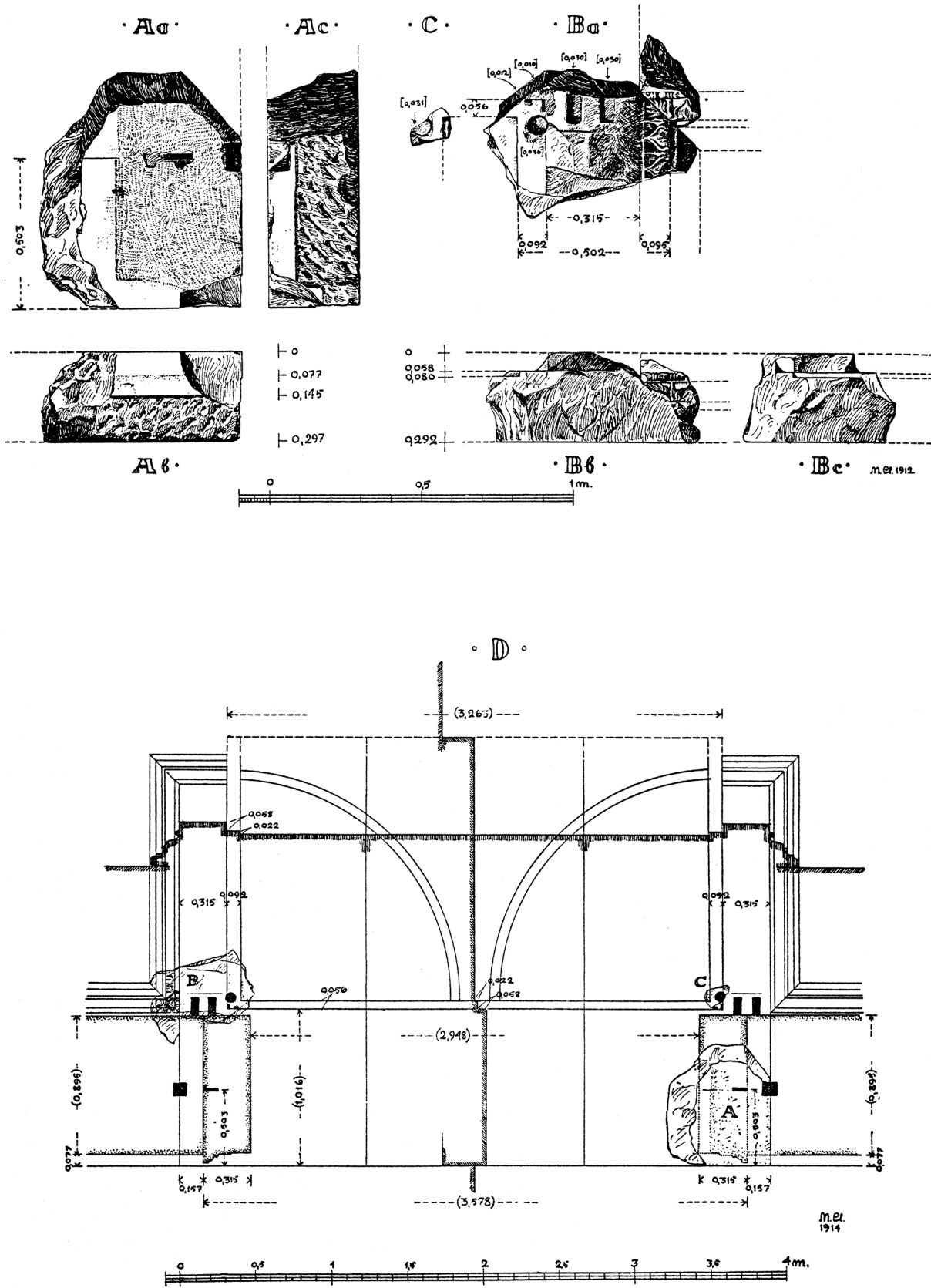

Figure 18. Blocks from the door toichobate (above) and reconstruction (below), as proposed in Dugas *et al.*, *Tégée*, pl. 63.

Norman argues that the pivot hole in Block B, *Fig. 18*, is too small for the main door of the temple and that the blocks should therefore rather be associated with the smaller north door.⁷¹ Dugas and Clemmensen suggest that Block A in *Fig. 18* can be reconstructed below the door jamb, but it cannot be linked with the recently discovered Block 802 from the door frame (*Fig. 8*): the two dowel cuttings on Block A indicate that there were originally two separate blocks on top of it, not a single block combining the door jamb and the orthostate as in Block 802. There are two possible explanations:

1. The frames of the two doors were substantially different and one of the blocks should be assigned to the east door and the other to the north door.⁷²

2. Block A in *Fig. 18* was not part of the doorways at the toichobate level: an alternative location could be below the large parastades of the eastern entrance to the cella.⁷³

Norman has suggested that a block with a *cyma reversa* moulding sketched by Clemmensen and assigned by him to the pronaos epikranitis course should actually be reconstructed as part of the monumental threshold of the east entrance.⁷⁴ The block was identified in the building block inventory (Block 315), and contrary to Clemmensen's rather summary drawing, the full original height of the block is not preserved. (*Fig. 19*) However, two further fragments of the threshold were also discovered in the survey: both have a part of the top surface intact, so the height of the threshold can now be confirmed as 0.410 m.⁷⁵ (*Fig. 20*)

The final aspect of the appearance of the doorways which requires a comment is Norman's reconstruction of a thicker eastern cella wall.⁷⁶ Her reconstruction is based on a single cella epikranitis block, and she is very likely correct in suggesting that the block is from the eastern wall, as is demonstrated by the careful transition of the decorative mouldings to simpler ones in the re-entrant corner.⁷⁷ It is, however, possible to demonstrate that a block of that size could equally easily be included in a wall with standard or slightly larger thickness. (*Fig. 21*) The interior epikranitis blocks are quite likely at the same level as the cassette ceiling blocks covering the pronaos, so the clamp at the other end of the epikranitis would in that case connect the block with the ceiling block (alter-

native A in *Fig. 21*). The ceiling block rests on top of the cross wall between pronaos and cella, but its contact surface with the cross wall does not need to be more than 0.10 m, so the minimum thickness of the cross wall is somewhere near 1.0 m. This reconstruction would not, however, explain why the foundations of the cross wall are much more massive than the wall between cella and opisthodomos at the other end of the cella.⁷⁸ Norman's nearly 2 m thick wall would provide a reason for the different sizes of the foundations, but a more economical solution would be to reconstruct parastades flanking the eastern doorway, as on *Fig. 4* and alternative B in *Fig. 21*. There is some archaeological evidence for reconstructing the parastades in the form of Block A in *Fig. 18* and with the re-entrant epikranitis block discussed above. In addition, the comparative architectural material lends support to the hypothesis: the temple of Zeus at Nemea has solid stone parastades that served as door stops for the leaves of the main door, thus protecting the carved details of the interior orders.⁷⁹ The parastades of the main northern entranceway in the temple of Apollo at Bassai had no practical function since the solution for the door frame employed there does not allow for a reconstruction involving door leaves.⁸⁰ Their depth is still equal to half the width of the entranceway, probably following the conventions used in normal doorways.⁸¹ The maximum length of the parastades at Tegea is provided by the wall foundations: in order to rest comfortably on the existing conglomerate blocks, they could not be much longer than 2.1 m. Since it is unlikely that the leaves of the door were wider than the length of the parastades, the maximum clear width of the door can be defined as twice this dimension, or 4.2 m.

In addition to the evidence that assigns the toichobate block with the hole for the door pivot to the northern door (Block B in *Fig. 18*) and the blocks from the parastade and the threshold to the main door (Block A in *Figs 18–20*), some further indications help to define the original position of two other blocks from the door frame. The current positions of the new blocks from the door jamb and the lintel, very close to the northern door, could imply that they probably are from that side of the temple; but as the single metope block discussed above shows (*Figs 6–7*), the place where a block was discovered is not necessarily directly related to its original position. In this case, however, the tapering side of the jamb block also supports an attribution to the northern door: since the pivot hole indicates that the door leaves were placed inside the cella, the inclined sides of the door frame would not have hindered the rotation of the leaves. For this reason the majority of the frame blocks should probably be assigned to the side door, as I have done in *Fig. 22*. The width

⁷¹ Norman, *Temple*, 184–5, 187.

⁷² There is a parallel in the temple of Apollo where the two doorframes are quite different from each other; Cooper 1992, pls 20.5–7 and 26–33; *id.* 1996, 210–28.

⁷³ The block is reconstructed below the northern parastade in *Fig. 4*. For architectural comparanda to monumental parastades flanking the main door, see notes 79–80.

⁷⁴ Dugas *et al.*, *Tégée*, 43, fig. 15; Norman, *Temple*, 187–8, figs 11–12.

⁷⁵ Blocks 122 and 311. The bottom surface of Block 311 is very fragmentary, so it is not possible to measure the effect of the bottom relieving edge on the block height; but with a measured height of 0.407 m, the original full height was most probably very close to 0.410 m also on this block.

⁷⁶ Norman, *Temple*, 185–6.

⁷⁷ Dugas *et al.*, *Tégée*, 53–4, pl. 80.

⁷⁸ The width of the pronaos foundations is ca. 2.7 m compared to ca. 2.1 m in the opisthodomos: Dugas *et al.*, *Tégée*, pl. 3–5. Concerning how the walls relate to the foundations, see *ibid.* pl. 18–20.

⁷⁹ Hill 1966, 26–7, pls 4 and 21.

⁸⁰ Cooper 1996, 210 and 216.

⁸¹ For the dimensions of the parastade and the entranceway, see Cooper 1992, pls 11 and 20.5.

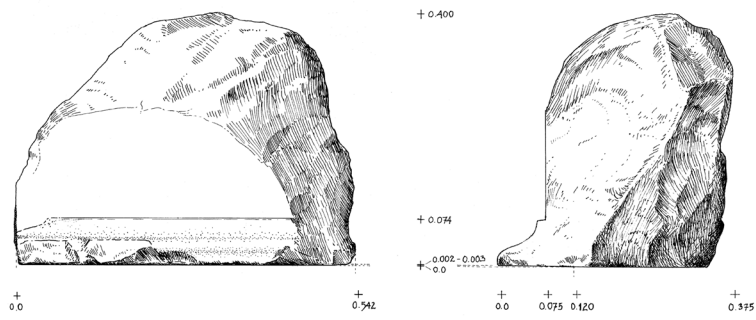

Figure 19. Block 315, from a threshold. (Drawing: T. Pöyhä, after Dugas et al., *Tégée*, 43 fig. 15)

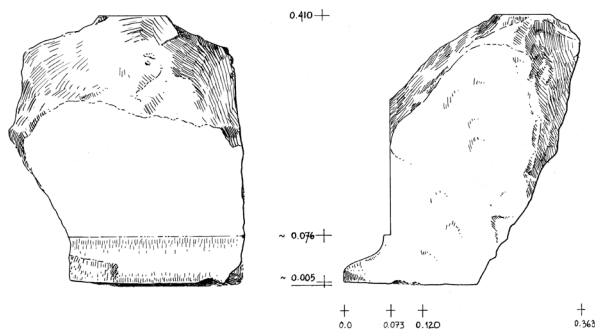

Figure 20. Block 122, from a threshold. (Drawing: T. Pöyhä 1996)

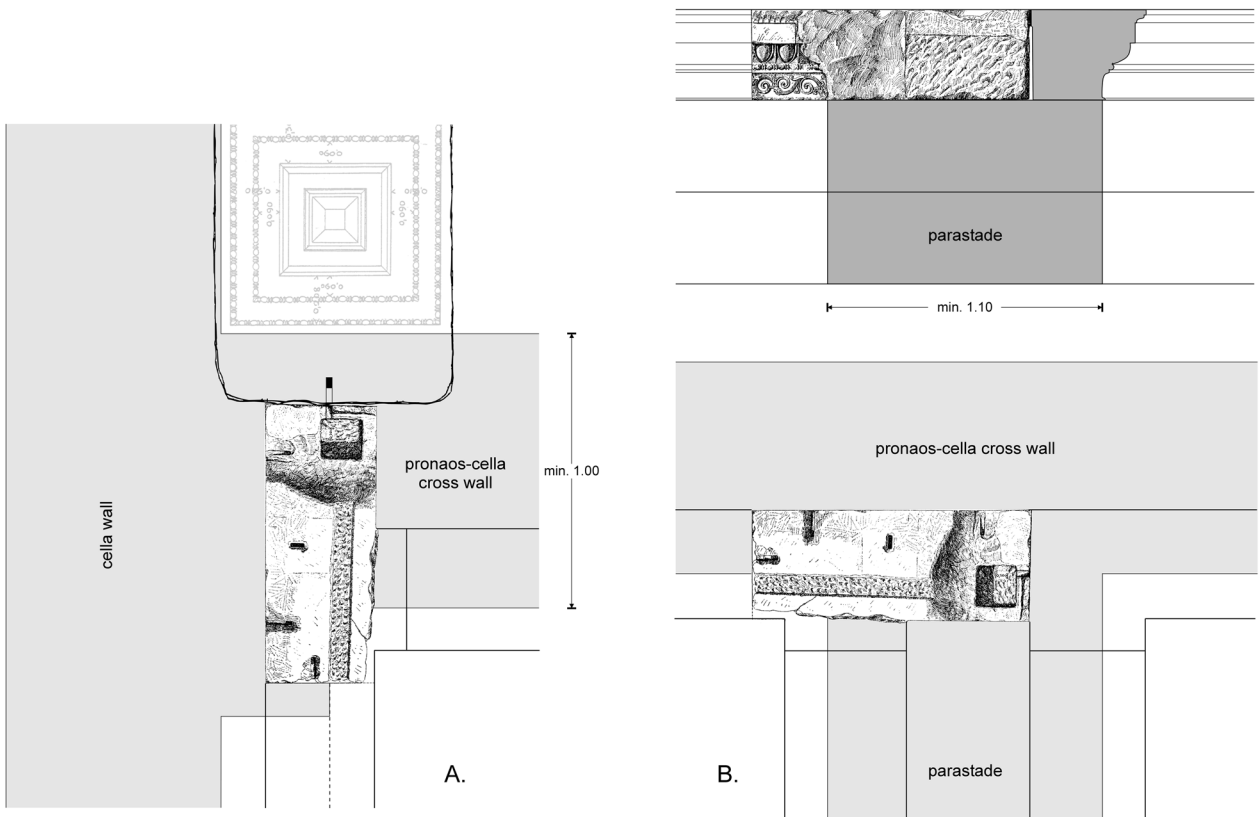

Figure 21. Proposed reconstructions A and B for the epikranitis level in the cella interior. (Drawing: Pakkanen 2006)

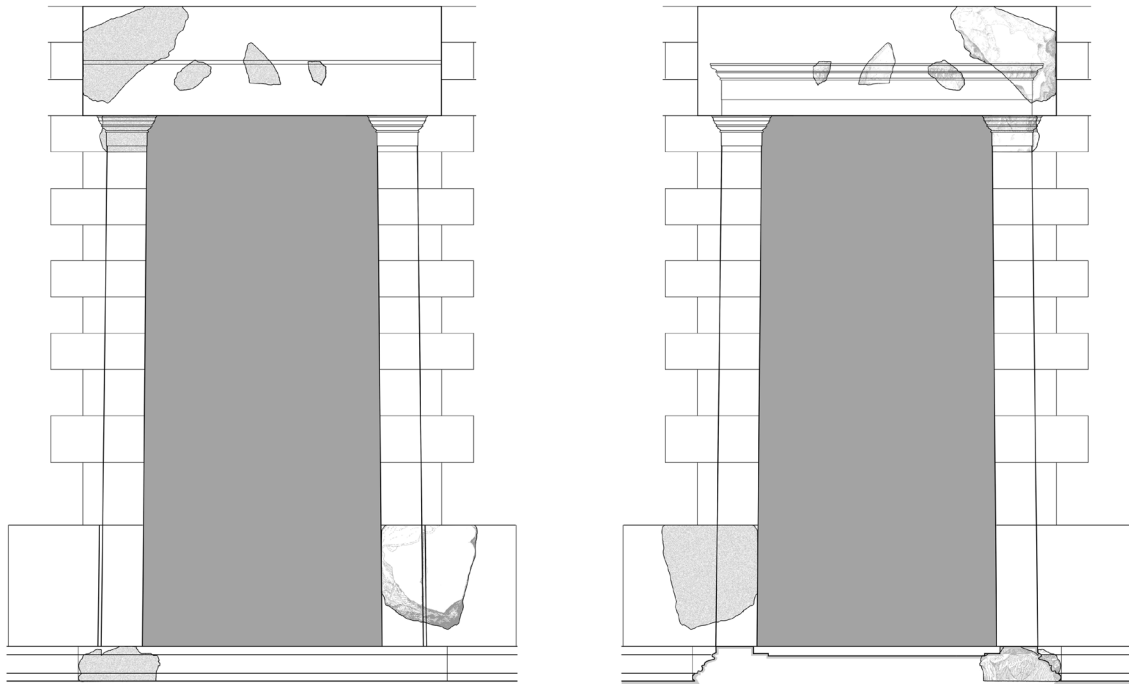

Figure 22. Reconstruction of the frame of the side door: exterior (left) and interior (right). (Drawing: Pakkanen 2006)

of the exterior pilaster is given by the orthostate block, and taking into consideration the transition from interior to exterior mouldings on the pilaster capital, the form of the exterior can be modelled on the basis of the two preserved faces of the block. The reconstruction of the outside face of the lintel with a plain fascia with an ovolo moulding above is based on the northern entrance door at Bassai.⁸² The pilasters remove the need for consoles to carry the lintel.⁸³ Its appearance towards the interior can be reconstructed with more confidence: the toichobate block preserves the profiles of the level below the threshold, and the fragments of the lintel and the capital allow for a reconstruction of the upper parts of the inside door frame with a good degree of certainty. The use of capitals to carry the lintel means that the leaves of the door could not have stretched all the way to the lintel, so a metal grille was most likely used in the topmost part of the opening – with obvious advantages for the lighting in the interior. The approximate width and the height of the doorway and its proportions are reconstructed on the basis of the interior arrangement of the cella at Tegea, supported by comparative material from Bassai and Epidauros.⁸⁴

⁸² Cooper 1992, pls 20.6 and 29.c; *id.* 1996, 216.

⁸³ Cf. Roux 1961, 150. Cooper 1992, pls 19 and 30, gives a possible reconstruction of the eastern lateral entranceway where the exterior pilaster capital is partially supported by a console (or crossette); see also Cooper 1996, 216, esp. n. 16.

⁸⁴ Cooper 1996, 217: the proportion of width to height in the northern, principal entrance is 1 : 2.3. Roux 1961, 149 reconstructs the size of the doorway in the tholos at Epidauros as ca. 2.3 × 5.4 m, with the same proportion.

The reconstruction of the temple plan in *Fig. 4* presents an interpretation of the cella interior based on the arguments presented above. The probable locations of some of the key blocks are marked in the plan: the toichobate block (*Fig. 18*, Block B) is connected with the northern door, the probable parastade blocks (*Fig. 18*, Block A and *Fig. 21.A*) are inserted at the toichobate and epikranitis levels, and the complete podium block with trace of a half-column on its surface (*Fig. 4.C*⁸⁵) is placed below a half-column in the southern wall.

Literature:

Bankel 1984 = H. Bankel, “Moduli an den Tempeln von Tegea und Stratos? Grenzen der Fußmaßbestimmung,” *AA* 1984, 413–30.

Cooper 1992 = F.A. Cooper, *The temple of Apollo Bassitas IV*, Princeton 1992.

Cooper 1996 = F.A. Cooper, *The temple of Apollo Bassitas I, The architecture*, Princeton 1996.

Dinsmoor 1950 = W.B. Dinsmoor, *The architecture of ancient Greece. An account of its historic development*, London 1950³.

Dodwell 1819 = E. Dodwell, *A classical and topographical tour through Greece during the years 1801, 1805, and 1806 II*, London 1819.

Dörpfeld 1883 = W. Dörpfeld, “Der Tempel der Athena in Tegea,” *AM* 8, 1883, 274–85.

Hellmann 2002 = M.-Chr. Hellmann, *L’architecture grecque I, Les principes de la construction*, Paris 2002.

Hill 1966 = B.H. Hill, *The temple of Zeus at Nemea*, revised and supplemented by C.K. Williams II, Princeton 1966.

⁸⁵ Dugas *et al.*, *Tégée*, 45, pl. 62.B; Pakkanen 1996, 161.

- Østby 1986 = E. Østby, "The Archaic temple of Athena Alea at Tegea," *OpAth* 16, 1986, 75–102.
- Pakkanen 1996 = J. Pakkanen, "The height and reconstructions of the interior Corinthian columns in Greek Classical buildings," *Arctos* 30, 1996, 139–66.
- Pakkanen 2004 = J. Pakkanen, "The temple of Zeus at Stratos: New observations on the building design," *Arctos* 38, 2004, 95–121.
- Roux 1961 = G. Roux, *L'architecture de l'Argolide aux IV^e et III^e siècles avant J.-C.* (BEFAR 199), Paris 1961.