

# INTERMODAL LOGISTICS SYSTEM SIMULATION MODEL & THE EMPTY CONTAINER FLOWS

Serkant KÖSELER

THESIS

Submitted in Partial Fulfilment of the Requirements for the Degree of  
**Master of Philosophy in System Dynamics**



**UNIVERSITY OF BERGEN**

SUPERVISOR

Prof. Paal Davidsen  
System Dynamics Group  
Geography department

# TABLE OF CONTENTS

Abstract.....6

## CHAPTER I

1. INTRODUCTION.....7  
1.1 Brief Problem Statement According to the Literature.....9

## CHAPTER II

2. THE CONTAINER LOGISTICS STRUCTURE.....13  
2.1 What's Logistics and Liner shipping?..... 13  
2.1.1 Pooling System and Pooling Companies..... 15  
2.1.2 3<sup>rd</sup> Part Logistics.....15  
2.1.3 The Ship's Agent.....16  
2.1.4 The Forwarding Agent.....16  
2.1.5 Equipment Management System in Liner Shipping Companies.....16  
2.1.6 Container Operations Management and Container Logistics Management.....17  
2.1.6.1 Container Fleet Management.....18  
2.1.6.2 Network Management.....18  
2.1.6.3 Demand Management.....18  
2.2 Container Flows Characteristics and the Empty Container Flows.....18  
2.3 What is a Container?.....20  
2.3.1 Container Classifications and Capacity Qualifications.....20  
2.4 Intermodal Concept.....21  
2.5 Container Terminal Productivity and Productivity Definitions.....23  
2.5.1 Historical Data for Port Productivity.....25  
2.5.2 Port Productivity Definitions.....27  
2.6 Container Cycle Time.....29

2.7	Pre-Shipment Planning.....	30
2.8	Land Management and Land Productivity for the Terminal and Harbor Area.....	31
2.9	Estimating the Land Required for Container Stacking Area.....	31
2.10	Required Space Calculation on the Vessel.....	32

## CHAPTER III

3.	LITERATURE REVIEW.....	33
----	------------------------	----

## CHAPTER IV

4.	MODEL BUILDING.....	39
4.1	Defining the Empty Container Problem with S.D Aspect.....	39
4.2	Model Boundaries.....	44
4.3	The Methodology Used for Creating the Reference Scenario.....	45
4.4	General Information About the Harbors and the Transportation Structure in the Scenario.....	46
4.4.1	Inland Transportation Modes and Inland Transportation Capacity Features.....	46
4.4.2	Crane Installation Structure and Capacity Features .....	49
4.4.3	Container Loading Structure of the Harbors .....	51
4.4.4	Container Unloading Structure of the Harbors.....	52
4.4.5	Container Transportation Routes Between the Harbors.....	52
4.4.5.1	Shipping Directions from Harbor A.....	53
4.4.5.2	Shipping Directions from Harbor B.....	54
4.4.5.3	Shipping Directions from Harbor C.....	54
4.4.6	One Container Cycle.....	55
4.5	General Assumptions for Loading & Unloading Operations.....	59
4.5.1	First Loaded Last Unloaded.....	59
4.5.2	Load is Shared by Each Loading/Unloading Crane Equally.....	60
4.5.3	Stocks.....	61
4.6	Modules.....	87

<b>4.6.1</b>	<b>MODULE-1</b> Calculating Number of the Containers Required for the Demand for Freight Transportation. ....	<b>87</b>
<b>4.6.2</b>	<b>MODULE-2</b> Empty Container Loading Pre-Planning at Harbor A.....	<b>89</b>
<b>4.6.3</b>	<b>MODULE-3</b> Full Container Loading Pre-Planning at Harbor A.....	<b>91</b>
<b>4.6.4</b>	<b>MODULE-4</b> Ship Capacity Effect on Full Container Loading Planning.....	<b>95</b>
<b>4.6.5</b>	<b>MODULE-5</b> Full Container Unloading Planning.....	<b>97</b>
<b>4.6.6</b>	<b>MODULE-6</b> Empty Container Unloading Planning at A.....	<b>99</b>
<b>4.6.7</b>	<b>MODULE-7</b> Filling Rate Planning at Harbor A According to the Ship Capacity-Equipment Capacity and Work Capacity (Resource Planning at A).....	<b>100</b>
<b>4.6.8</b>	<b>MODULE-8</b> Harbor Productivity Module.....	<b>102</b>
<b>4.6.9</b>	<b>MODULE-9</b> Idle Container Ratio.....	<b>107</b>
<b>4.6.10</b>	<b>MODULE-10</b> Empty Container Ratio.....	<b>110</b>
<b>4.6.11</b>	<b>MODULE-11</b> Network Module at Harbor A( Number of Ships Arriving & Departing).....	<b>110</b>
<b>4.6.12</b>	<b>MODULE-12</b> Inventory Level Effect on Transportation Selection Mode at Harbor A.....	<b>115</b>
<b>4.7</b>	<b>Validation</b> .....	<b>116</b>
<b>4.7.1</b>	<b>Extreme Condition Test</b> .....	<b>116</b>
<b>4.7.2</b>	<b>Sensitivity Test</b> .....	<b>118</b>
<b>4.7.3</b>	<b>DimensionalConsistency</b> .....	<b>120</b>
<b>4.7.4</b>	<b>Structural Assessment</b> .....	<b>121</b>

## CHAPTER V

<b>5.</b>	<b>POLICY DEVELOPMENT</b> .....	<b>123</b>
<b>5.1</b>	<b>Equilibrium</b> .....	<b>124</b>
<b>5.2</b>	<b>The Reference Scenario</b> .....	<b>127</b>
<b>5.3</b>	<b>Analyzing the Empty Container Inventories in the Reference</b> .....	<b>130</b>
<b>5.3.1</b>	<b>Inventory A</b> .....	<b>131</b>

5.3.2	Inventory B.....	135
5.3.3	Inventory C.....	143
5.4	Policies Applied to the Model .....	148
5.4.1	Policy-1: Inland Transportation Capacity Increased 10% .....	149
5.4.2	Policy-2: 10% Increase in the Loading/Unloading Capacity.....	153
5.4.3	Policy-3: Customer Container Holding Time Reduced to 3 Days.....	154
5.4.4	Policy-4:Oversea Transportation Time is Reduced by Designing Faster Ocean Carriers.....	158
5.4.5	Policy-5:Unloading Cranes' Capacities Increased by Purchasing a 250 Container Unloading Capacity Crane.....	158
5.4.6	Policy-6: Designing Ocean Carries Having Bigger or Smaller Carrying Capacities.....	160
5.4.7	Policy-7:The Number of the Containers in the Harbors and the Demand for Transportation are Increased 7%.....	161
5.4.8	Policy-8:The Number of Containers in the Warehouses and the Demand for Transportation is Increased 7%.....	162
5.4.9	Policy-9:Empty Container Inventory of Warehouse-1 C is Supplied with Leasing Containers.....	163

## CHAPTER VI

6.	CONCLUSIONS.....	165
6.1	References.....	167
	Appendix A: CD Containing the Simulation Model and the Equations of the Model.....	170

## ***Abstract***

*“ the average container is idle or undergoing empty repositioning for over 50 % of its life span...” (CRINKS Paul, 2000) High volume of empty container movements and low container productivity are the main problems of the container logistics. “Like with all trucking companies, whether they will admit or not, we don’t know where all our trailers are...” (Brown, Ike. Co-owner of National Freight Company). The high dynamism, complexity and myriad of delays render the logistics structure more difficult to manage and control. The alterations in the demand generate fluctuations in the behavior. On the other hand, the high dynamism and complexity make it difficult to envisage the whole mental picture of the logistics structure. A generic simulation model of an intermodal logistics system is created to draw this mental picture and System Dynamics aspect led us thorough this high dynamic and complex path. The main shortcomings of the structure are simulated, the causes of the shortcomings are analyzed in detail and possible policies are developed for the cure.*

**KEY WORDS:** *Container; Empty Container Flows; Intermodality; Harbor Operations; Container Cycles, Inland Transportation.*

# CHAPTER 1

## *1. Introduction*

Container logistics system is a very high dynamic system with many delays and blind spots. It contains very different transportation modes as well. In this paper, this structure is named as an intermodal system, as a container logistics system or as a container chain. This intermodal system gives the managers various kinds of choices and possibilities while making decisions. The delays and the blind spots render the system difficult to handle, control and manage. Currently it is almost impossible to have 100% control over the system. The increased technology and the studies done in this field increase the control and reduce the weak points of the logistics system. Although those studies and the high technology detections, it is manifest that the productivity level is not satisfying yet. To illustrate, the empty equipment transportation is still considerably high; therefore the cost of the empty equipment transportation still constitutes a big percentage in the budget. Studies demonstrate that this percentage is around 30%. Instead of the increased technology and container tracking systems, the empty container level is still around at a 20% level, besides there are some empty container flows just to keep the system in balance. For instance, from harbor A to B and from harbor B to A, empty containers are transported at the same time to keep the system in balance. These kinds of empty flows are named as bi-directional empty container flows. The high level of bi-directional empty equipment flows are one of the negative impacts reducing the productivity of the container logistics system.

The delays in the system and the high uncertainty make the transportation companies keep high level of container inventories as well. Studies demonstrate that a container is idle 50% of its life span. High container inventory levels create unproductive container utilization. A basic container price is around 2000\$, when the number of idle containers and the price of a container are considered, it is concluded that the companies are paying huge amount of money for their idle assets.

The container logistics system contains many decision phases as well and it gives the managers many decision initiatives to fulfill the transportation tasks. Therefore the system is so dependent on the managers and it is so vulnerable to the possible wrong decisions of the managers.

In this study, a cycle of a container with all the operations for a successful transportation is scrutinized; i.e. a picture of a container cycle is drawn by creating a dynamic simulation model. The model is build upon some main assumptions. For instance, it is assumed that the containers complete their cycles in a shorter time and deliver the demand, this logistics system is managed better and has a higher productivity. The harbor operations and harbor productivity have effects on the container cycles. A transportation company doesn't have a control on the harbor operations and harbor management systems; but there is an obvious causality between the container flows and the harbor. To make the effect of the harbor productivity on the container cycle time more clear, the dynamic simulation model is built up as if the transportation company had control on the harbor operations as well. This idea may give new insights to the intermodal transportation structure for the future ownerships and management characteristics

First of all, the deep-sea container logistics system is mainly explained. Information about the management types in container logistics is given, then a generic simulation model of a deep-sea container logistics system that the containers flowing between three harbors is built.

The model is consisted of twelve main modules: (**MODULE-1**) Calculating Number of the Containers Required for the Demand for Freight Transportation, (**MODULE-2**) Empty Container Loading Pre-Planning at Harbor A, (**MODULE-3**) Full Container Loading Pre-Planning at Harbor A, (**MODULE-4**) Ship Capacity Effect on Full Container Loading Planning, (**MODULE-5**) Full Container Unloading Planning, (**MODULE-6**) Empty Container Unloading Planning at A, (**MODULE-7**) Filling Rate Planning at Harbor A According to the Ship Capacity-Equipment Capacity and Work Capacity (Resource Planning at A), (**MODULE-8**) Harbor Productivity Module, (**MODULE-9**) Idle Container Ratio, (**MODULE-10**) Empty Container Ratio, (**MODULE-11**) Network Module at Harbor A (Number of Ships Arriving & Departing), (**MODULE-12**) Inventory Level Effect on Transportation Selection Mode at Harbor A.

The container logistics model is built according to the general container flow structure and the model is modified as to give the expected behaviors such as around 20% empty container flows, 50% idle container time, and around 80% harbor productivity etc... Finally, new policies are developed and introduced to increase the container productivity by reducing the empty equipment flows.



## **1.1 BRIEF PROBLEM STATEMENT**

With the advance of containerization in 60's the transportation process gained a more dynamic, faster and fast growing characteristics. The containerization will go on growing and according to the contemporary situation it is assumed to go on growing with an increase around 7% per year until the year 2015.

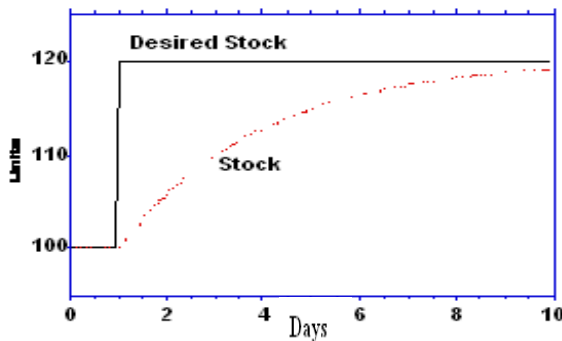
Ocean carriers currently spend close to \$ 100 billion per year operating their container assets, and industry analysts estimate that approximately \$16 billion of that is directly attributable to the total cost of repositioning empty equipment to the point of its next cargo. Due to information gaps or "blind spots" along the transport chain, equipment is only visible to carriers between 60 and 80 per cent of the time. These blind spots prevent container operators from realizing all the equipment management options currently available to them, such as interchange or triangulation, that result in more efficient equipment usage. (Crinks, Asset Management in Global Container Logistics Chain, 2000). The reports say that the blind spots in the container logistics chain occur especially while moving via truck, rail or in inland terminals or at shipper/consignee premises.

The container logistics chain contains many delays in its structure. These delays create a structure difficult to handle or control. The problem lies in the delicate structure of container logistics. As to some of those delays: Inland terminal – Origin Harbor travel time, terminal stuffing time, container loading/unloading time, origin harbor-departure harbor travel time, berth time, ship catastrophe time, pilotage and mooring time, weather delays, port delays, departure harbor-inland terminal travel time, customer container keeping time, container damage surveying time and etc. Container damage surveying establishes a good precedent for a delay. Interchanges are very important for the container sector. The increased damage and repair in some lines are big disadvantages. The line has difficulty controlling the damages. So that, no interchange occurs without the container being surveyed by an independent surveyor. If it is not possible at that location, the container is transported to the nearest location for survey. In stead of completed in hours, this process takes 3 days to conclude. According to U.K P&I Club shows that for the years 1987-1990 the average for major cargo claims:

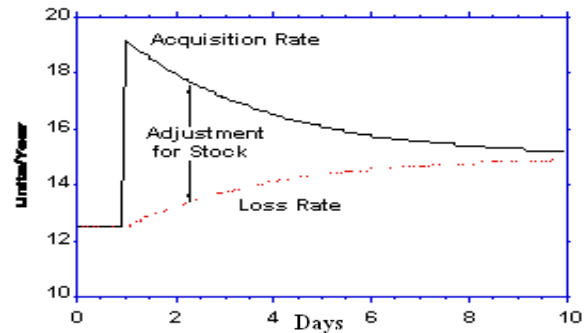
- 23% due to bad stowage
- 8% due to bad handling

- 2% due to fraud
- 1% failure to collect cargo (Alderton, 2005, pp. 206)

The logistics chain contains many stocks, inventories and bottlenecks. The bottlenecks and the delays create a delicate structure difficult to handle. It's a high dynamic structure and it is difficult to see and understand the whole picture. One shortcoming in one of these bottlenecks, inventories or facilities may create unenviable consequences in the system. It's better to explain the delicacy of the logistics chain with an example. As exemplified before, due to the high delay and delicate structure, the desired situations in the system may easily change. A delay due to the bad weather conditions or a technical problem on the ship may make the manager change the desired situations.



**Figure-1.1**  
*20% Increase in the Desired Situation*



**Figure-1.2**  
*Amplifications in the Production Rate*

**Figure - 1.1** depicts a 20% change in the desired situation. To illustrate, if there is a 20% increase in the demand it means that there should be a 20% increase in the number of the containers we need; in other words an increase is required in the number of the containers we order routinely. Exemplifying the graphs above would be conducive to understand how delicate and difficult it is managing the stocks. For instance, we were keeping 100 containers as a stock and ordering 13 containers everyday to keep the inventory in desired level. In the case of an increase in the demand creates a 20% of increase on the desired stock of containers. To keep the stock in the balance there should be an increase in the number of the containers we order. On the other hand, **Figure - 1.2** depicts that increasing 20% the number of the containers we order daily is not enough to increase the stock 20% and to keep the inventory in balance; i.e. by increasing the orders 20% it is not possible to catch the 20% increased desired situation. There will always be an oscillation, and after that amplification the system will catch the balance. **Figure - 1.2**

depicts this amplification, and there is a ratio for this amplification. To reach the balanced situation in a case of 1% increase for a desired situation, the ratio is 2.65; i.e. if we increase the desired situation 1% we have to increase the order rate  $1\% * 2.65 = \%2.65$  in the beginning, and this amplification ratio has a decreasing tendency, and the desired situation is reached, the amplification disappears. In a case of 20 % increase there would be an amplification of  $20 * 2.65 = 53\%$  (Pål Davidsen, GEO-304 Course slides, slide no: 43-44-45).

As for the container logistics chain, containing many delays and stocks in the structure, the system is very sensitive to the amplifications; because these amplifications create a dynamic structure very difficult to manage and handle.

The problems of the container logistics are listed as:

- ❑ High level of empty equipment flows
- ❑ High level of bi-directional empty equipment flows
- ❑ Long cycle times of containers
- ❑ High level of container inventories
- ❑ High level of idle asset or equipment

The tracking factor of containers increased with the developing information technologies. Instead of these developments, it is concluded that the container logistics system has not reached the satisfying level of productivity. High level of empty equipment flows, high level of bi-directional empty equipment flows decrease the productivity of the system. As mentioned before, approximately 30% of the budgets of the container shipping and transportation companies are allocated for the empty equipment movements and at the same moment harbors are sending empty equipment mutually. The structure needs balancing empty equipment flows to survive.

A container begins its journey from the origin harbor when the demand for the transportation is received, and sails from the origin harbor to the destination harbor where the customers are, and from the customers the container flows back to the origin harbor to fulfill its new duty. A

container cannot complete its cycle in a desired time due to the delays during its transportation, the logistics structure should keep more containers to meet the possible demand for freight transportation or should postpone transporting the freight until the containers finish their cycles and be ready for a new journey to transport the new freight of customers. As long as the container has a slow circulation; i.e. if the container has a long cycle time, it is assumed that the container has a low productivity. To overcome the problems in meeting the possible customer demands for freight transportation, the managers prefer to keep high level of containers and this tendency creates structures having very low container productivity. The idle assets or the container being idle 50% of its life time is one of the consequences of this tendency. A container is productive as long as it is moving.

## ***CHAPTER II***

### ***2. THE CONTAINER SHIPPING LOGISTICS STRUCTURE***

As mentioned before, this paper is created on the aspect of “System Dynamics”. Container logistics system is scrutinized and a dynamic simulation model is built-up with the system dynamics aspect. Containers flow around the whole world between the harbors. The container logistics structure is huge, high dynamic and complex; therefore it is not possible to create the identical intermodal structure. “Only a part of the real world is reflected in a model, and the real system behavior can only be predicted within certain limits “(Cast, 1989). In this chapter, information about how the intermodal logistics structure and the container sector are working is given. A picture of a container cycle is drawn, and a model is built-up according to the information given in this chapter. Besides, definitions of some management types are given as well; and these definitions are expected enlighten us while developing policies in *Chapter 5*.

#### ***2.1 What Is Logistics and Liner Shipping? Liner Shipping Related Terms and Management Types***

Logistics is an optimization process of the location, movement and storage of resources from one point of origin, through various economic activities to the final consumer. With advent of containers and other intermodal devices, liner shipping should no longer be considered simply part of sea transport, but as an internal part of a logistics or system approach to transport.” (M.Alderton, 2005) The simplest process, transport process can be depicted as H-T-H, as Handling-Transport-Handling. The purpose of the transport process is said to be to bridge the space between sources and sinks. The handling process must be included at least twice in transport process. (Hulten, 1997)

Shipping Lines are the links between the global supply chains. Liner service is the backbone of international trade in manufactured goods. Liners, sailing on regular schedules along established

ocean trade lanes, move vast quantities of consumer industrial and military commodities. (Helmick, Jon S, 2001)

The Liner Shipping and the containerization is a fast growing sector. Containerization International Yearbook reports that the total port handling movements in 2002 were 276.5 million TEU, and it is forecasted that this volume will increase up to 576.4 million TEU by the year 2015. This implies an annual average growth rate over the period of 6.9 per cent per annum, which is somehow higher than the rate at which the global containerized cargo market is expected to grow. Excess capacity is likely to be a feature of liner shipping for the foreseeable future. This will continue to place a pressure on operating margins, and provide strong incentive for shipping lines to minimize logistics costs of which empty container movements are major component. At the same time, increasingly sophisticated container tracking and management procedures should provide opportunities for realizing economies in this area. ([www.unescap.org/ttdw/Publications/TFS\\_pubs/pub\\_2398/pub\\_2398\\_ch5.pdf](http://www.unescap.org/ttdw/Publications/TFS_pubs/pub_2398/pub_2398_ch5.pdf))

The systems (Container Systems) are characterized by a high degree of uncertainty in the demand for transport, in processing times when the container is not under the carrier's control and in the availability of external resources. Since the demand fluctuates and the supply cannot be easily changed, this means that if the service level shall be high and transports not rejected, then the capacity must be adapted to the highest demand. As a result of extensive service competition, Janson and Schneerson (1987), Stopford (1992) there has been a buildup of excess capacity, e.g. large container fleets to prevent shortages. (Hulten, 1997)

The port can be viewed as a complex system containing several entities. The physical entities include: port space, channels, warehouses, equipment, technical, ships, cargoes, passengers, manpower, transportation means, gates, companies, agencies, and customs. The financial entities include: cost and revenue. Other entities that affect port operations are: environments, control and inspection, planning, administration, research and development, manpower training, pollution, security, communications, regulations, operating methods and politics (Hassan, 1993)

### ***2.1.1 Pooling Systems and Pooling Companies***

A liner shipping company may own all its own equipments and manage all these assets while doing its business. When there is an expected shortage in the container inventory the company may lease or purchase these equipments. If a contemporary shortage occurs in one of the harbors or chains, the equipment manager has three options to solve the problem: a. Interchanging the container (Leasing contract is transferred from one line to another) A container is borrowed by another liner shipping company on the same line. 2. New containers can be leased from a leasing company. 3. New containers purchased from a container manufacturing company.

The pooling companies are supposed to develop in two phases: Leasing and Neutral phase. In leasing phase, if a liner shipping company is part of a pooling system, there are equipment pools that the company can use in a case of shortage. The liner shipping company is charged according to the service served. In the neutral phase, the liner shipping company owns no equipments. All the equipments they use are owned by the pooling company. In this way, no extra effort used to manage the equipment, and the company focuses only on its shipping and transportation facilities.

### ***2.1.2 Third Part Logistics (3PL) or Contract Logistics***

3PL is the supply chain practice where one or more logistics function of a firm outsourced to a 3PL provider. Typical outsourced logistics functions are: inbound freight, customs and freight consolidation, public warehousing, contract warehousing, order fulfillment, distribution, and management of outbound freight to the client's customers.

3PL Provider manages and executes these particular logistics functions using its own assets and resources, on behalf of the client company. The purpose is to render the firm competitive by keeping it without owning many assets, allowing it to focus on niche areas and to reduce operational costs. Third part logistics is also referred to "Contract Logistics".

### ***2.1.3 The Ship's Agent***

The ship owner need a “mister fix it” or ship’s husband. Such a person will need to know every aspect of the port. In other words, the agent has to be able to find an answer to all problems concerning the welfare and smooth running of the ship and crew during its stay in port. The owners prefer two agents in the harbor: Looking after the owner’s interest and the other taking care of the charter’s interests.

### ***2.1.4 Forwarding Agent***

Forwarding agent is a logistics expert who traditionally advises the cargo owner on the best way to move the cargo from A to B and to assist in the preparation of the necessary documentation.

### ***2.1.5 Equipment Management in Liner Shipping Companies***

Error! Objects cannot be created from editing field codes.

*Figure - 2.1*  
*Basic Decision Process Model of the Liner Equipment Manager*

*Figure - 2.1* denotes the decision process of an equipment manager in shipping line. He receives data constantly from the agents, dispatchers and from the Equipment Management System (EMS). EMS is a computerized system which gives the current level of the equipment level and equipment location. Mainly it has 7 modules: Tracking, Maintenance and repair, contracts, billing, forecasting, optimization and booking.

The shipping agent is responsible for the inland transport and tracking. Dispatcher (logistic manager) is responsible for the logistics in each marketing department. He receives reports from the sales department and container tracking system. He keeps his file on container needs. If containers are not available for the demand, he checks the nearest location. He can consider and allocate the containers for demand. He makes estimation, which containers are the most economical to use. If there is a shortage in the line, the dispatcher gets in touch with the line’s equipment manager and interchange is made after consultation with equipment manager. The



dispatcher tries to create a mental picture of the current container situation since the computer does not provide any graphic information. The dispatchers postpone their decisions as long as possible in order to take into account the latest information. Otherwise the decision might be based on a state of the system which was no longer valid when the decision is implemented (Hulten, 1997)

Dispatchers have to make decision under certainty. From the tracking system database they can get information about the last recorded event for a particular container or latest recorded stock levels in depots. Another source of uncertainty is the level of detail in the information. If a container is stored at a depot, the exact location in the depot may not be given by the tracking system. Uncertainty is also due to that the dispatchers cannot be sure that all containers scheduled for transport with a ship actually shipped since in case of lack of space or time (Hulten, 1997)

### ***2.1.6 Container Operations Management and Container Logistics Management***

While developing new policies for the logistics system, it would be conducive to know with which policy recommendation what kind of management type is done. Thus, we can classify each of our policy recommendations. Mainly two kinds of managements are done in a container logistics system: Container operations management and container logistics management. Both of those managements are closely related with container fleet management, network management and demand management.

#### ***2.1.6.1 Container Fleet Management***

Container fleet management is concerned with the problem of supplying containers for transport services at the least possible cost while complying with the standards and reaching goals for the system's performance. In long term container fleet management is part of the network management and in short term the fleet management is limited by the structure of the network.

#### ***2.1.6.2 Network Management***

Network management is determining the structure of the transport network. The main goal is developing the least possible cost transport network. But the consequences how much the network is efficient can be evaluated in long term.

### ***2.1.6.3 Demand Management***

Demand management is concerned with influencing the demand for transport. The goal of the demand management is in the long term to promote the trade development and in the medium to short term to maximize the profit given the total demand for the transport.

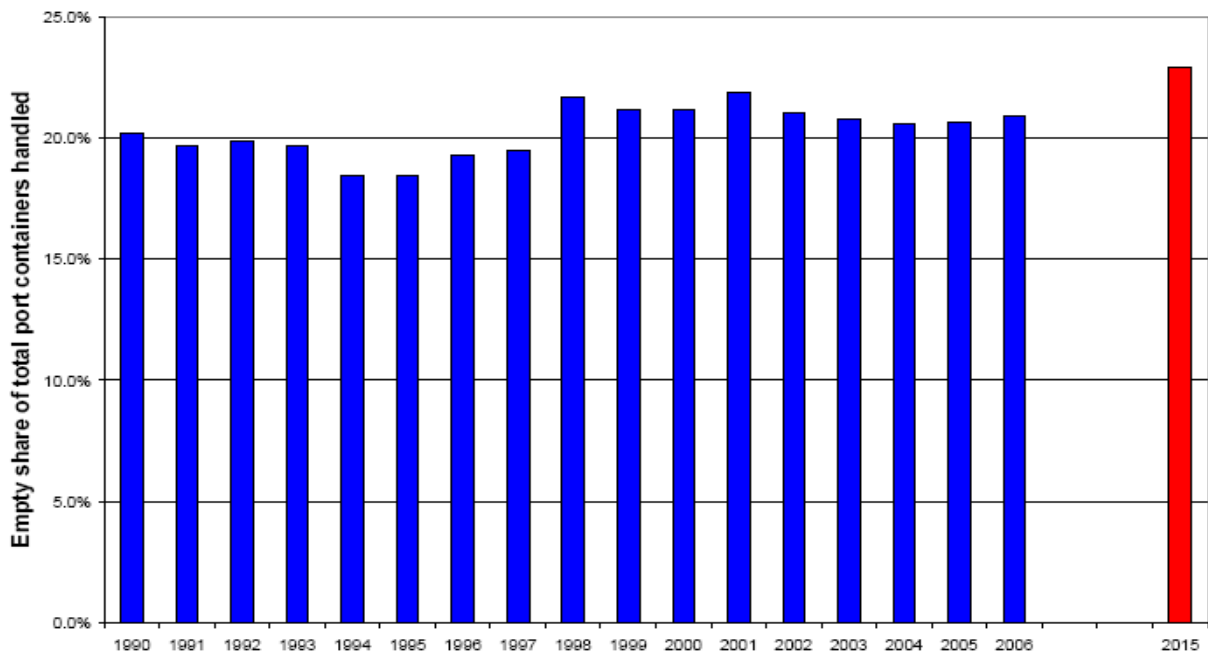
As for the container operations and container logistics management, container logistics management concerns with the demand management, while the container operations management concerns not (Hulten, 1997)

## ***2.2 Container Flows' Characteristics and the Empty Container Flows***

The containers flowing between the global supply chains can be characterized mainly in two types: Full Containers and Empty Containers. Typically logistics managers' main concern is the transportation of loaded containers. They would prefer to ignore empty containers completely, but this is not possible since real world container networks usually require empties to account for imbalances in loaded flows. If empty containers are not managed carefully, the entire shipping network will operate inefficiently.

In the current containers circulation, the containers are moving as two main flows: full and empty containers. The harbors are sending and receiving empty and full containers; i.e. the harbors are importing and exporting full and empty containers constantly. On the global level there is an extensive positioning of empty containers and in many areas, empty containers are both imported and exported (Drewry, 1992). The empty ones are filled according to the demand and the capacity features of the harbor. To keep the liner shipping system in balance, the harbors are importing and exporting empty containers in both directions to each other. These kinds of container flows are named as "Bi-Directional Empty Container Flows" consist a considerable part of "Empty Container Positioning". Bi-directional empty container flows constitute the

inefficient part of the container flow structure and the empty positioning is the benefit or efficiency reducing part of this system.



Source: Drewry Shipping Consultants

**Figure-2.2**  
**Empty Share of Container Movements (1985-2006, 2015)**

**Figure - 2.2** shows the ratio of empty containers to total containers handled in ports over the last 20 years and the expected, estimated volume of empty containers by the year of 2015. Until the year of 1996 the trend was on the wane in the ratio of empty to full containers, for the increased sophisticated container logistics works, the number of empty container movements reduced gradually. In 1998, the ratio increased to well over 20 per cent. This was due to the emergence of very pronounced imbalance in the two main Asian trades with Europe and North America caused by the Asian currency crises. This imbalance has persisted though to see present day. (Choong, Cole, Kutanoglu, 2002)

Crainic, Gendreau, and Dejax in their study estimated that for a major European container shipping company the land movements cost approximately U.S \$50 million and of these 40% were empty truck movements (University of Rutgers, Final Report of 2007)

For the liner operators, containers are a classic example of a commodity. Competition is thus vigorous because the service provided is usually very similar for all the liner companies. Prices are as a result low and margins very slim. Understanding the real cost of every operation and

choosing the right policies can make the differences between failure and success for a containership liner company (Wei; Hoon, 2004).

A major component of a shipping company's total operating cost is associated with relocating empty containers around its many ports. Due to the imbalance of the international trading, some areas are export dominant and some are import dominant. This imbalance has created certain challenges in the management of empty containers (Wei; Hoon, 2004).

### **2.3 *What is a Container?***

In liner shipping the majority of the general cargo is unitized as the most common unit load device (ULD) in shipping is the container. A container is the most successful unit for integrating cargo packaging so far. Consequently, the container fleet and the container ships are the most important means of transport in the international cargo traffic (Wei; Hoon, 2004). Containerization International Market Analysis (1996) presented the following data for mid 1995. The total fleet of containers surveyed was at 9.2 million TEU (Twenty Foot Equivalent Unit) equaling approximately 4.5 million units. Of the containers surveyed 96.3% were 20 feet or 40 feet containers, and of these 99.5 % had maritime specifications.

#### **2.3.1 *Container Classifications and Capacity Qualifications***

The Containers are mainly classified in two: General Cargo Containers and Specific Cargo Containers. General Cargo Containers are: 1. General Purpose Containers 2. Specific Purpose Container. Specific Cargo Containers are: 1. Thermal Containers 2. Tank Containers 3. Dry Bulk Containers 4. Named Cargo Types.

Most Common container sizes are 20, 28, 40, 48 feet containers. Other sizes for example 10 feet is especially for military purposes. Typical Container height is 8 feet and 6 inches. Standard width of containers in international commerce is 8 feet.

Recommended Load Value (**RLV**)

<u>RLV</u>					
□	20` = 1170 cft	33.131 cbm	1000 cft	28 cbm	24,000kg
□	40` = 2385 cft	67.535 cbm	2050 cft	58 cbm	30,480kg
□	40` HiCube=2690 cft	76.172 cbm	2350cft	66 cbm	30,480kg

## 2.4 *Intermodal Concept*

The prevailing definition of intermodality is the movement of goods in one and the same load unit between two destinations utilizing more than one mode of transport. (UNECE et al, 2001)

The emergence of intermodality has been brought about in part by technological development (Hayuth, 1987). A number of transshipment technologies have been developed over the last 30 years (Woxenius, 1998), but the major driving force for intermodality is the advent of containerization. The containerization process started in the maritime sector in 1960's as a response to a trade increase has facilitated the integration among different modes since.

Each transport mode (i.e. air, sea, rail, and road) has its own comparative advantages and disadvantages with respect to parameters such as lead time, costs, environmental impact and capacity. For example air transportation is traditionally used for time-sensitive, low density, high value goods, while rail is normally reserved for high density goods of low value with limited time constraints (Lumsden et al, 1998)

The logistics aim of transportation is that it should meet a goal mix, consisting of demands for cost and quality. (Christopher, 1992) The theoretical possibility of fulfilling this goal mix by combining the comparative advantages of traffic modes in a transport chain is the fundamental idea behind intermodality ( Guthed et al. 2005)

Guthed et al (2004) have developed a framework for analyzing the performance of a physical goods flow through a surface-bound intermodal transport chain. Performance is defined as a composition of five parameters: transit time, frequency, reliability, information management and

agility. Public/political factors are also added to embody the legal structure in which the transport companies operate (Zuo, 2006).

Theoretical intermodal concept is focused on the transfer of load units between transport modes. However, practitioners acknowledge the transfer of information and responsibilities between involved companies as key issues (Guthed, 2005). The performance of multi-mode transport chains should depend on the coordination of activities, with both technical and organizational implications (Guthed 2005).

Guthed et al's paper (2005) shows a growing attention to problems associated with the inter-organizational coordination intermodality. Through two extensive case studies in the North-Europe, Guthed et al proposed three key areas that are interrelated closely and essential to attain effectiveness and efficiency in an intermodal assignment: interfaces, chain integration, and resource utilization, including both technical and organizational aspects to reflect the characteristics of intermodality. He found that high resource utilization is necessary for being cost effective whereas the intermodal performance depends on the interfaces and the chain integration (Zuo, 2006). A more appropriate description of intermodal transportation could be technical, legal, commercial and management framework for transporting goods in an unbroken ITU (Intermodal Transport Unit) by successive modes of transportation.

## ***2.5 Container Terminal Productivity and Productivity Definitions***

Production may be regarded as a transformation from one state of the world to another. More generally, production may be defined as any activity, the net result of which is to increase the degree of compliance between the quantity, quality and distribution of products and a given preference pattern. Productivity may vary, however due to several differences such as (i) differences in production technology, (ii) differences in the efficiency of the production process, and (iii) differences in the environment in which production occurs (Lovel, 1993)

Productivity is the measurement of the volume handled per unit of time. It is in the choice of the volumes, and in the amount of time used as divider that ports differ. The usual productivity

indicators: Ship productivity, the divider is the duration of the call in the port, which is usually either the total turn-round time, or the time at berth; crane productivity, the divider is the number of net gross or net crane hours.

There are different ways of calculating the productivity of the harbor. In a specific period of time an optimum number of loaded or unloaded containers can be determined. By comparing the current number of loading and unloading operations with the optimum number of operations it can be determined that how far away we are from the optimum level or another single factor can be an indicator for the productivity of the terminal, to illustrate the optimum number of the labor can be determined according to the time spend for each loading/unloading operation by each container loading/unloading crew for each container, and a comparison can be made according to the optimum and current total number of crew working for the loading/unloading operation. But it should never be neglected that the levels specified in a period of time can vary according to the technology, political situation, environmental situation and etc.

Productivity is affected by several factors, several of them being quite obvious:

- Berth congestion creates delays before berthing, decreasing the ship productivity measured against the total turn-round time, even if berth productivity is correct
- Availability of equipment is another factor, higher productivity being achieved by using several gantries on a ship, if the characteristics enable it (PMAESE-Operation Committee, Port Productivity Analyze,

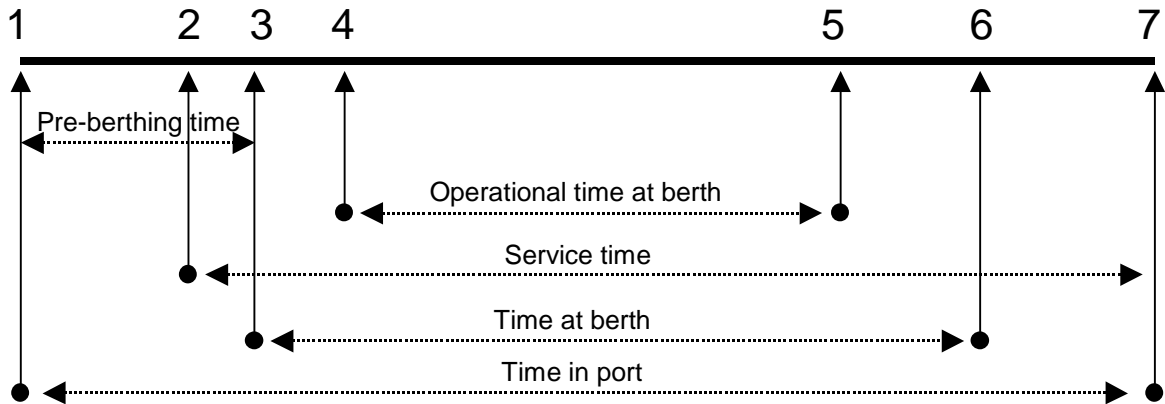
<http://www.pmaesa.org/Operations/PORT%20PRODUCTIVITY%20ANALYSIS.doc>)

For the determination of the optimization numbers in terminal productivity, a number of measurements have been undertaken using either an engineering approach or an economic approach. A definition of the two optimum throughputs is provided by Talley (1988, pp.328-329)

- A port's engineering optimum throughput is the maximum throughput that can physically be handled by the port under certain conditions for a specified time period.
- A port's economic optimum throughput is the throughput that satisfies an economic objective of the port for a specified time period (Song; Cullinane; Roe; 2001). The economic objectives and the productivity determined according to those economic objectives are dominant in a terminal managed by a private port.

As for a public port, maximizing the throughput with a ZERO deficit or a ZERO profit object can be dominant.

In this study the determining variables are dominantly related with those variables: Berth occupancy ratio, service time, waiting time, dwell time, berth utilization.



**Figure-2.3**  
*The Variables for Evaluating the Harbor Productivity*

Number	Event
1	Arrival at port (outer anchorage for instance)
2	Pilot on board
3	Ship at berth (end of mooring for instance)
4	Start of operations
5	End of operations
6	Departure from berth
7	Departure from the port (pilot dropped for instance)

**Figure-2.4**  
*Harbor Operations*

- Ship's time in port (or turn-round time) = 7 – 1
- Service time = 7 – 2
- Time at berth = 6 – 3
- Operating time at berth = 5 - 4

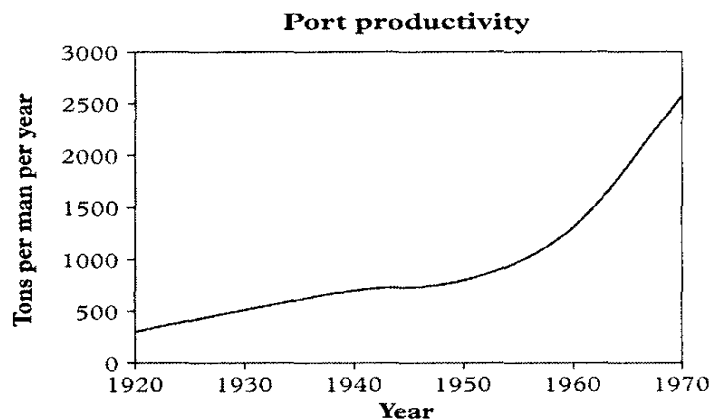
(PMAESE-Operation Committee, Port Productivity Analyze,

<http://www.pmaesa.org/Operations/PORT%20PRODUCTIVITY%20ANALYSIS.doc> )



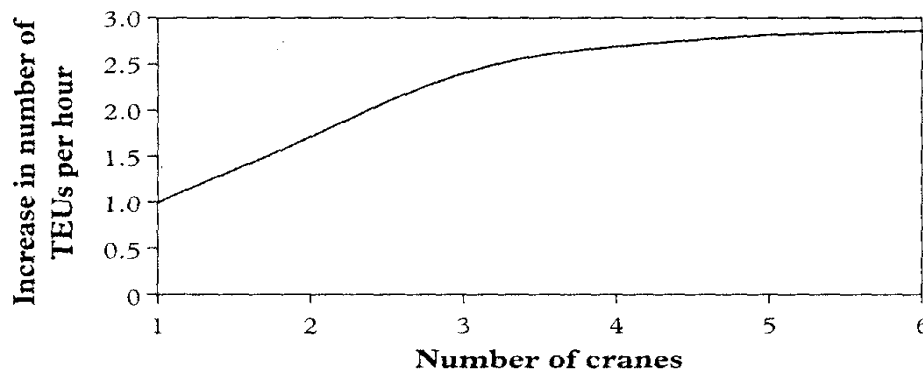
### 2.5.1 Historical Data for Port Productivity

Figure 2.5, 2.6, 2.7, 2.8 depict the historical data. The data is conducive in making comparisons to evaluate how much the model is successful. The gap between the data and the behavior of the model demonstrates how much the harbor model is realistic. As mentioned before, the productivity of the harbor can be calculated by different ways. Total weight as tonnage per worker, total weight as tonnage per crane, loading and unloading speed of cranes, annual throughput per hatch, cargo handling speed and the ship size and etc. can be good indicators while making evaluation about how much the harbor model is realistic.



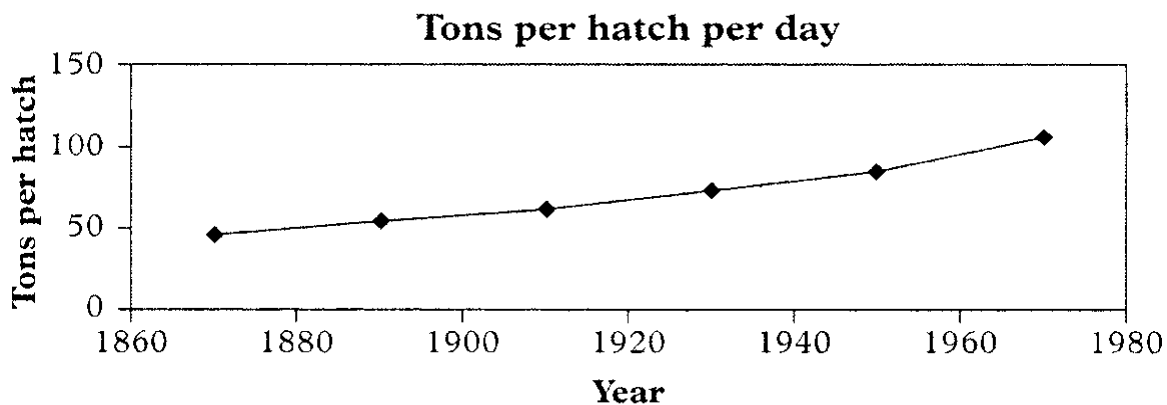
**Figure-2.5**  
*Historical Data for Productivity*

Figure-2.5 shows the historical data for productivity. It demonstrates that productivity was relatively stagnant from around 1930 to 1960. From the 1960's, unitization in its various forms, the increasing use of specialist ships and the carriage of cargo in bulk, has encouraged large increases in port productivity (Alderton, 2005, pp.206)

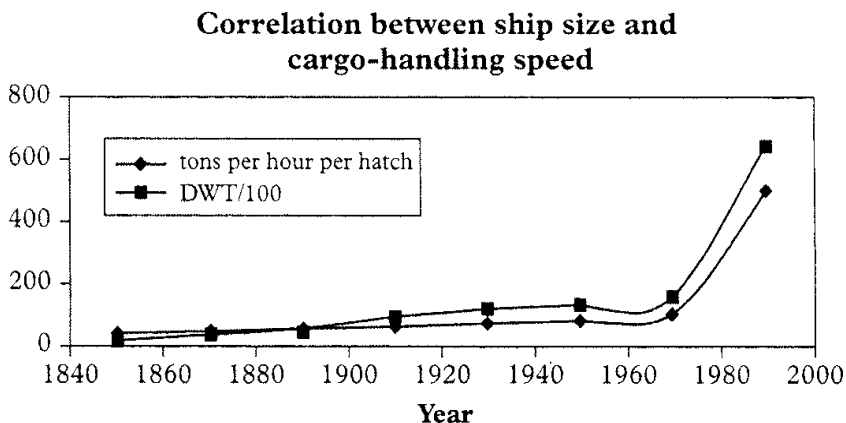


**Figure-2.6**  
*Historical Data for Each Crane Loading/Unloading Capacity*

Containers loading/unloading speed are virtually the same. Speed in boxes per hour per crane = 10-50 (Average 30 for good port). For large mother ships at a container center port, 80 moves per hour should be expected.



*Figure-2.7*  
*Ton Per Hatch Per Day*



*Figure-2.8*  
*Correlation Between Ship Size and Cargo Handling Speed*

### 2.5.2 Port Productivity Definitions

*Berth Occupancy Ratio* is the ratio of the time the berth is occupied to the time the berth is available during a considered of time

$$\text{Berth Occupancy Ratio: } \frac{\text{The time the berth is occupied}}{\text{The time the berth is available during a considered of time}}$$

*Service Time (TS)* is the period of time during which a vessel is berthed in a port whether the ship works or not. The service time will include the working and non working periods.

*Waiting Time (Wq)* is the time a ship is waiting for an available berth.

*Waiting Ratio* is the ratio of waiting time to the service time

$$\text{Waiting Ratio : } \frac{Wq}{TS}$$

*Berth Utilization* is the ratio of service time to possible working days

$$\text{Berth Utilization : } \frac{TS}{\text{Possible Working Days}}$$

For a general purpose berth with an occupancy ratio around 0.7 could be considered about right. (Alderton, 2005, pp.134)

One of the most commonly used statistics is Berth Occupancy Ratio. This ratio is obtained by the time a berth or group of berths has been occupied divided by the time the berth or group of berths available during a considered time.

$$\text{Berth Occupancy Ratio : } \frac{\text{The time a berth or group of berths has been occupied}}{\text{The time the berth or group of berths available during a considered time}}$$

*Berth Utilization Ratio* is the ratio of the occupancy time to the working time. This ratio can be a useful productivity indicator as well.

$$\text{Berth Utilization Ratio : } \frac{\text{Occupancy time}}{\text{Working time}}$$

For each crane or “Cargo-handling gateway” measure the number of boxes per crane in both the total ship time on the berth time and the working ship time on the berth can be a useful indicator or the number of people employed in the terminal concerned with cargo handling can also be measured per equipment. Therefore annual number of boxes per person and per piece of equipment per annum can be measured.

*The Length of Berth*, the ratio of berth length to the number of cranes is a useful indicator.

$$\text{Berth Length / Number of Cranes} = 350 \text{ m If Vessel Capacity} < 1500 \text{ TEU}$$

$$\text{Berth Length / Number of Cranes} = 130 \text{ m If Vessel Capacity} > 1500 \text{ TEU}$$

***The Ratio of TEU to the total terminal area***

This ratio seems to vary between 0.53 and 2.1

**The Number of TEU / Terminal Area in Squares**

*Average Vehicle Turnaround Time*, The time of each vehicle in the terminal when receiving/delivering containers. For an efficient port the average should lie between about 20-30 minutes.

*Number of Boxes per Person Annually* There is no average yet available, but one million boxes per person is a good ratio, or 2500 ton per person is a good ratio.

## **2.6 Container Cycle Time**

A container flows during its whole life span. The flow can be described shortly as a route Origin Terminal Loading-Terminal Destination-Inland Centers or Warehouses- Customer-Inland Center-Terminal Loading. From the inland inventories the container moves to harbor by one ways of the transport modes. Arriving at the harbor, the freight is loaded and the container is placed to the ship by the loading operations. The containers wait in the ship according to the ship capacity. Because the ship owners wouldn't like to leave without their ship is full. Therefore the ship waits

as possible as much. Then the container sails with the ship to the destination harbor and when the container arrives at the destination harbor the containers begin the inland journey according to delivery locations. From the harbor by a barge, truck or by rail the container moves to the main delivery centers in the inland. Arriving at the inland centers, the customers receive their products and keep the container according to the time they are allowed or according to time stated in agreement between the freight company and them. This journey the containers make between different lands and harbors is regarded as cycle time of the containers.

Blyth, on the East Coast of the U.K, it is estimated that only about 20% of the arriving containers drive straight out of the port, the rest goes into one or other of the port facilities for unpacking, storage, repackaging, or stacking onto pallets for onward distribution (Alderton, 2005, pp. 148).

The turnaround time for a container transport system between two areas as the time from when a container is sent to a shipper for stuffing, to when it has returned to the same area and is ready once again sent to a shipper for stuffing or begins an empty overseas transport (Jarke, 1981). Mencl and Krenkel (1987) studied the inland cycle times and the sea voyage separately. They define an inland cycle as commencing when a container is discharged and ending when it returns to the port for export. The waiting time in the port before the vessel departs is not regarded as belonging to the inland cycle. (Hulten, pp. 69, 1987)

## ***2.7 Pre-Shipment Planning***

The demand for freight transportation to another land or harbor is received, the planning facility begins. The equipment, the operations, the operation crew, the stowage plan are done; i.e. a resource allocation work is done in each time when the demand is received. One of the major problems facing a large container terminal's management is reducing unproductive and expensive container movements within the terminal. This is quite complex, for instance export containers have to be sorted by:

- The Ship
- The port of discharge
- The type of container, e.g. TEU, FEU, Reefer etc.

- The weight of container into heavy, medium or light
- Dangerous cargo

The stowage plan should be flexible as some containers may arrive late and errors are made in the movement of containers through the terminal. An example quoted in Lloyd's List in August 1998 for a large container ship loading in Far East, demonstrated that around 10% changes in stowage plan were necessary, mostly in the latter stages of loading. Such last minute changes can cause serious problems for the ship's officers as the stability of container ships need to be carefully checked and the ballast adjusted for any changes in top weight. If a reasonable pre-shipment plan isn't perpetrated, there can be observed long queues of trucks to deliver their freight waiting in front of the harbor or there can be observed many ships waiting docking. All these factors reduce the productivity of the harbor, and increase the cost of transportation, reduce the quality of the cargo shipment by delayed deliveries to the customers.

## ***2.8 Land Management and Land Productivity for the Terminal and Harbor Area***

In the countries where the land is expensive, high land productivity is required. Land productivity has a vital impact on container stowing style. If the land is cheap and if there is no limitation in the space low height of stacking and stowing is preferred; on the contrast where the land is expensive high height piles and stowage is required. High stacking of containers will probably mean more unproductive lifting and moving of containers. The container stacking style has another important effect on the productivity of the harbor and on the speed of loading/unloading operation.

## ***2.9 Estimating Land Required for Container Stacking Area***

Annual Throughput:	Ty	
Daily Requirement:	Dr	Dr= Ty/365
Dwell Time:	Dt	Expressed in days or fraction of days
Peaking Factor:	Pf	An allowance for peak conditions. Often assumed to be 0.75
TEU ground areas:	15.25 m <sup>2</sup>	

Stacking area: TGS (Twenty feet ground slots)

Stacking Height: Sh

TGS:  $(15.25 * Dr * Dt) / Pf / Sh$

Global Yard Area/Total TGS Area = e

Total Container Stacking Area in m<sup>2</sup> = Total TGS Area \* e

Approximate e factors for

Straddle Carriers: e = 1.8

Transtainer: e = 1.3

Front Loader: e = 3.9

Reach Stacker: e = 2.3 (Alderton, 2005, pp. 139)

## ***2.10 Required Space on the Vessel***

To find the space required by any consignment, the weight of the cargo is multiplied by the stowage factor, on conversely the space divided by the stowage factor gives the weight that might be put in that space.

**Space Required on the Vessel: Weight of Cargo \* Stowage Factor**

**Weight: Space / Stowage Factor**

Stowage Factor of any commodity is the number of cubic feet (cubic meters) which a ton of that commodity will occupy in stowage.





## CHAPTER III

### *3. LITERATURE REVIEW*

The intermodal logistics is a big dynamic structure. This study is done to see and draw the current and the future aspect of this complex system. The studies from the basic mathematical models to the high dynamic simulation models are reviewed to depict this complex mental picture. As mentioned before, the intermodal system is consisted of different transportation modes. Some of the studies focused on one mode and these studies tried to demonstrate the effect of one mode on the whole system, whereas the other studies focused on the whole chain or transportation modes as a generalized aspect.

Dejax and Crainic (1987) carried out a review of problem related to the transportation of empty equipments, or vehicles, such as containers for reutilization, separately or jointly with the transportation of loaded containers.

H.Raman and G.Ramkumar in their study “Simulation model for analyses of waiting time of ships and berth occupancy in ports” scrutinized the waiting time of ships and berth occupancy. The model analyzes the sensitivity of waiting time or pre-berthing time of ships and berth occupancy with respect to duration of detention at berth, time lost due to wave height constraint for the tugs in the turning basin and increase in number of vessels calling the port. Reduction in detention time at berth can be achieved namely by improving the methods of cargo handling and increasing the manpower of servicing of ship at berths.

In 1989 Thalenius-Adolfsson (1989) studied the flows of cargo carrying equipment and introduced term “Operational Imbalance”. The total flow of the loaded and empty containers, rail cars and semi-trailers in Swedish international trade 1982, 1984 and 1986 was reported.

In 1990 the container shipping is studied by Chadvin. He focused on the cost and capacity of container terminal operations. He emphasized the importance of the terminal time in his study.

Drewry (1992) studied “Global Empty Positioning of Containers”. The study based on the port statistics assembled from Containerization International Yearbooks, reveal in 1991 21% of all container movement is empty container movement. An example of simulation tools to assist fleet

management is a model developed for a shipping line by Lai et al (1995). The model is used to determine policies for a port to port repositioning, on and off-hiring of leasing containers and container inventories by port. A two step heuristic is used to search for the best policy.

In order to understand the complicated interconnected port operations better, we can divide the port operation generally into four categories: ship transport mode operation, cargo handling operation, warehousing operation and inland transport operation says Said Ali Hassan in his study which he created a port activity simulation (1993). Hassan created modules to replicate the port operations, and with those modules he measured the efficiency and made analysis for the current and future state of the harbor expanding according to the economic realities. For example, with the Port Management Decision Support Tool (PMDST) he gauges the current port performance and future state of the harbor. In short, he created a general simulation model which replicates most of the harbor facilities. In this study Said Ali Hassan's main classification in interconnected port operation was taken as a main reference.

Luca Maria Gambardella studied on the forecasting, planning and simulation integration in the intermodal container terminal in his study "Simulation and Forecasting in Intermodal Container Terminal" (1996)

Lars Hulten (1997) studied the Container Logistics and Management. In his study he explained the liner shipping structure and created a management model for better container logistics management. In his study he emphasized the importance of the information about the current situation of the logistics system. He created a relation between the term of entropy and the contemporary situation of the system. The entropy decreased in a system, the system begins working more properly; i.e. the more the information we have about the contemporary situation of the system, the less entropy the system has in; so that the system can be managed more efficiently. If we have more letters we can understand or estimate more about the whole meaning. (Hulten, 1997).

Fleischmann et al (1997) and Fleischmann (2001) published a review of quantitative models for reverse logistics. They discussed the various dimensions of the reverse logistics context and they analyzed works pertaining to reverse distribution, inventory control in systems with return and production planning with reuse parts and models.

De Brito et al (2003) have published a review of case studies in reverse logistics. They analyzed over 60 cases, pointing out the variety of real life situations, and have presented comparison tables explaining how the reverse logistics activities are undertaken.

The term of cycle time of a container was studied by Jarke (1981), and specific case studies were done later, to illustrate, transports in Scandinavia for a carrier serving in North Atlantic trade.

Simulations have widely been used and applied for planning and management of the port system. (Borovits and Ein-Dor, 1990; Hassan, 1993; Collier, 1980; Merkurjev et al., 1998; Greet and Janssens, 1998; Gambardella et al., 1998). Nilsen and Abdus-Samad (1977) provide a thorough justification for modeling port operations through discrete-event simulation rather than through analytical queuing models. A port simulation model can be used for determining the effects of changes in throughput, and various operational, technological, and investment options (Hassan, 1993).

The importance of the integration of simulation, planning and forecasting in the intermodal container terminals were studied by Gambradella, Bontempi, Taillard, Roanego, Raso, Piermari in the year of 1996 and this study is named as “Simulation, and Forecasting in Intermodal Container Terminal”. In order to solve the unpredictability of the imported and exported container flows and the optimized resource allocation they created a system composed by three strictly connected modules: Simulation, forecasting and planning. The simulation module was created to replicate the entities and the processes which are constantly going on in the container terminal. The forecasting module was created to collect and analyze the historical data to make estimation and prediction for the possible future state, and the planning module was created to optimize the whole processes and operations in the terminal and the container locations. This study shows how this goal (One major goal for the management of an intermodal terminal is to increase the productivity and decrease the costs at a greater extent) may be pursued by integrating methodologies of artificial intelligence, simulation and production management (Gambradella, 1996)

Ramazan Mat Thar and Khalid Hussain made a case study on the Keland Container Terminal and created a container terminal operations simulation model in the year of 2000. The model had two main functions: The berth allocation and the crane and the prime mover allocation functions. Mat and Hussain re-organized the arrivals and departures of the ships according to the berth, container

quantity and the berthing ship characteristics. They compared the statistics showing the potential capacity of the Kelang Container Terminal.

Gambardella, Zaffalon and Mastrolilli created a container terminal operations simulation model in 1999 in their study “Simulation for the Evaluation of Optimized Operations Policies in A Container Terminal”. In this study the resource allocation (RA) and well managed terminal operations were related to each other. The main purpose of this study was to create alternative scheduling policies in the harbors. A simulation model basically consisted of three modules: arrival generator which creates the container inflows, replicating the trucks arriving and bringing full or empty containers; ship planner which allocates the cranes shifts, the crane allocation according to the expected import and export containers, and assigning the destinations for unloading and delivering the export containers; and the yard planner module to manage the container allocation to provide optimized crane performance. With the computer assist study 30% of resource saving was achieved. Simulation results show that the application of computer generated management policies could improve the terminal performance, making possible allocation of fewer resources, thanks to a better usage of the yard cranes (Gambardella; Zaffalon; Mastrolilli, 1999)

A study indicating the long time planning horizon generating better empty container management consequences was done by Sook Tying, Michael H. Cole and by Erhan Kutanoglu in 2002. A mathematical model to minimize the total cost of empty containers and satisfying the customer demands was created. The main functions of this model were: the empty container flows from the supply customer to the demand customer, the empty container flows from the container inventory to the demand customer, the number of available containers in the container inventory and the number of containers leased, borrowed or purchased from outside of the current system. Although the appropriate length of the planning horizon depends on the network under consideration, a longer planning horizon can give better empty container distribution plans for the earlier periods. The longer horizon allows better management of container outsourcing and encourages use of slower cheaper transportation modes (Tying; Cole; Kutanoglu, 2002).

$$\begin{aligned}
 \text{Min} \quad & \sum_t \left[ \sum_s \sum_i \sum_m C_{sim} u_{sim}^t + \sum_s \sum_j \sum_m C_{sjm} u_{sjm}^t \right] \\
 & + \sum_t \left[ \sum_j \sum_i \sum_m C_{jim} v_{jim}^t + \sum_j \sum_k \sum_m C_{jkm} v_{jkm}^t \right] \\
 & + \sum_t \sum_j H_j v_{jj}^t + \sum_t \sum_j R_j w_j^t \\
 \text{s.t.} \quad & \sum_m \sum_{s \in S_{im}'} u_{sim}^t + \sum_m \sum_{j \in I_{im}'} v_{jim}^t = X_i^t \quad \forall i, t \\
 & \sum_m \sum_{i \in I_{im}'} u_{sim}^{t+T_{sim}} + \sum_m \sum_{j \in I_{im}'} u_{sjm}^{t+T_{sjm}} = Y_s^t \quad \forall s, t \\
 & v_{jj}^t = v_{jj}^{t-1} + \left( \sum_m \sum_{s \in S_{jm}'} u_{sjm}^t + \sum_m \sum_{k \in \bar{K}_{jm}'} v_{kjm}^t \right) + w_j^t \\
 & \quad - \left( \sum_m \sum_{i \in I_{jm}'} v_{jim}^{t+T_{jim}} + \sum_m \sum_{k \in \bar{K}_{jm}'} v_{jkm}^{t+T_{jkm}} \right) \quad \forall j, t \\
 & v_{jj}^t \leq SL_j \quad \forall j, t \\
 & \sum_i \sum_{s \in S_{i3}'} u_{si3}^t + \sum_j \sum_{s \in S_{j3}'} u_{sj3}^t + \sum_i \sum_{j \in I_{i3}'} v_{ji3}^t + \sum_j \sum_{k \in \bar{K}_{j3}'} v_{kj3}^t \leq BL^t \quad \forall t \\
 & u_{sim}^t, u_{sjm}^t, v_{jim}^t, v_{jkm}^t, v_{jj}^t, w_j^t \geq 0, \text{ integer}
 \end{aligned}$$

*Figure-3.1*  
*Mathematical Model Generated by Tying, Cole and Kutanoglu*

*Figure-3.1* depicts an optimization under some realistic restrictions.  $C_{sim}$  represents the cost per container. The gist of this mathematical model is to minimize the costs under the assumptions such as stock of empty containers at a container pool at the end of a period cannot exceed the storage limit of the container pool. The storage capacity is represented as  $SL$  in the model.  $V_{ij}$  indicates the initial inventory. Compared to this mathematical model, cost function is excluded from this study of intermodal logistics simulation model and some realistic constrictions depicted on *Figure - 3.1* are inspired and utilized for the intermodal logistics simulation model in this study.

The container deployment problem was studied by Sun Wei and Hum Sin Hoon in the year of 2004. A mathematical model was created according to the constraints in forecasting and demand balance, according to the constraints in planning the most beneficial-economical route, and according to the constraints in the terminal and route capacity. The goal function of this study was created according to the maximum profit minus minimum costs. To achieve the goal the shipment routes were re designed and the most economical routes were created. This study can be regarded as a ‘‘Fleet Management’’ study.



## CHAPTER IV

*In Chapter-1 an introduction to methodology of this paper is done and the main problems of the container logistics system are introduced as well. In Chapter-2, the characteristics of the container logistics system is explained in detail, numerical formulations are introduced and historical data is given. In Chapter-3, the studies and the researches in empty container logistics are scrutinized as " Literature Review."*

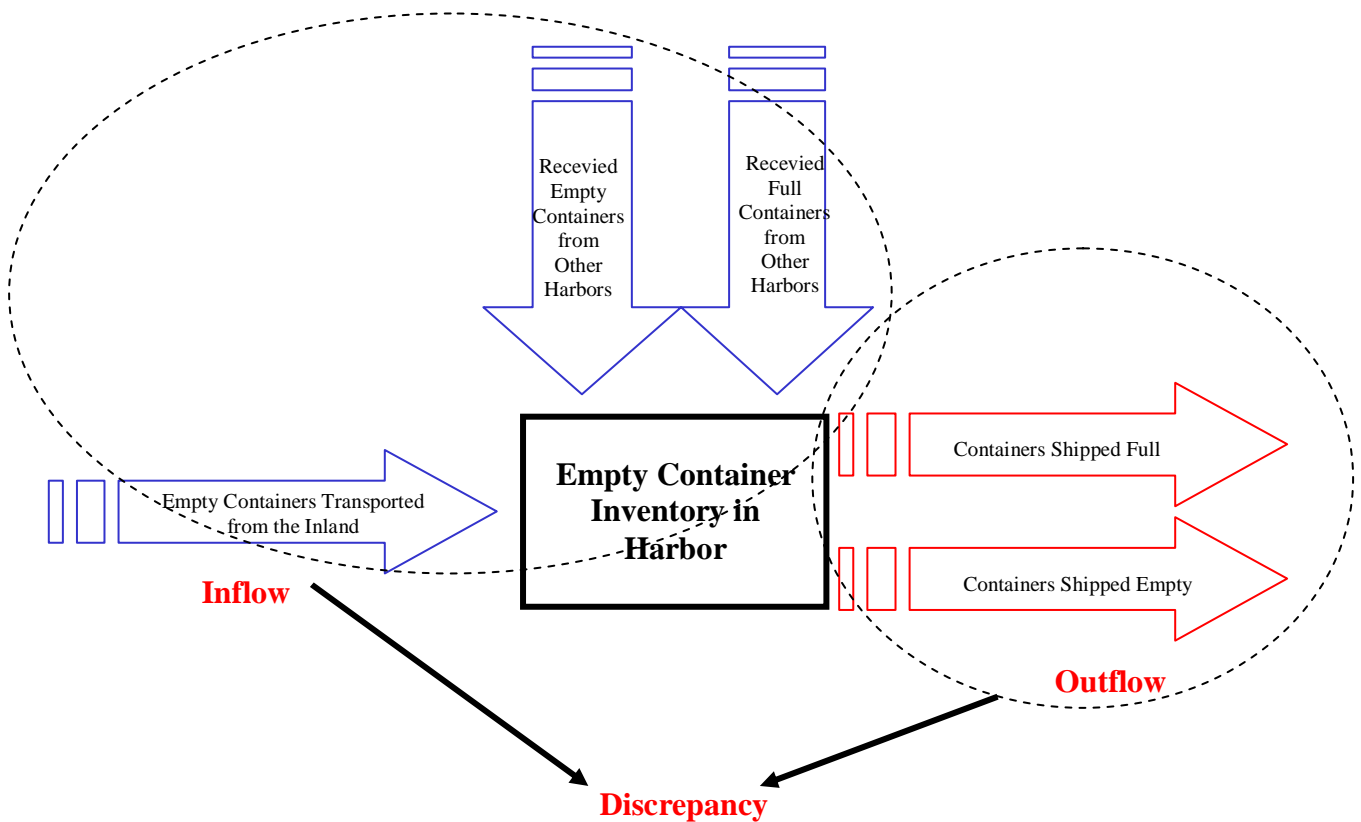
### **4. MODEL BUILDING**

In *Chapter - 4*, the empty container flow problem is evaluated and defined from the point of "System Dynamics" aspect. The boundaries of the model is drawn, and a reference scenario is created; i.e. a big intermodal logistics system is generated as a scenario. There are three harbors sending empty and full containers in the reference scenario. The harbor facilities, the inland transportation and warehousing operations are included. The characteristics of the intermodal logistics system is defined according to the numeric features given in *Chapter - 2*; i.e. a simulation model compatible to the characteristics introduced in *Chapter - 2* and replicating the reference data of empty container volumes and idle empty container level is generated in *Chapter - 4*. The simulation model is consisted of 12 modules. Lastly, validation is done to evaluate how much the model is compatible to the realistic condition.

#### ***4.1 Defining the Empty Container Movement Problem with S.D Aspect***

Containers are flowing constantly between harbors. Each harbor has a desired empty container inventory level. *Figure - 4.1* shows the inflows and outflows of the empty container inventory of the harbor. Each harbor is receiving demand for freight transportation from one harbor to another. The demand is received, the planning facility begins and the number of the containers required for this transportation demand is calculated; i.e. the demand for transportation is converted into the number of containers. From that time on, the demand is regarded as number of containers. Empty and full containers are leaving by being shipped from the harbor and these departures constitute the outflow of the empty container inventory of the harbor. At the same time, each

harbor is receiving empty containers from the warehouses from inland and full and empty containers from the other harbors. These containers constitute the inflow of the empty container inventory in the harbor. More than 80% of the containers flowing from the other harbors are full. The full containers sent by the other harbors and arrived at the destination harbor can be used after they are transported to the inland warehouses, delivered to the clients and sent back to the harbor. The empty containers sent by the other harbors and arrived at the destination harbor can be used at once when they arrive at the destination harbor. In this study, the full container deliveries to the clients in the harbors are neglected. It is assumed that all the full container arrivals are transported directly to the inland and delivered to the clients in the inland.



*Figure - 4.1*  
*Inflows and Outflows in the Harbors*

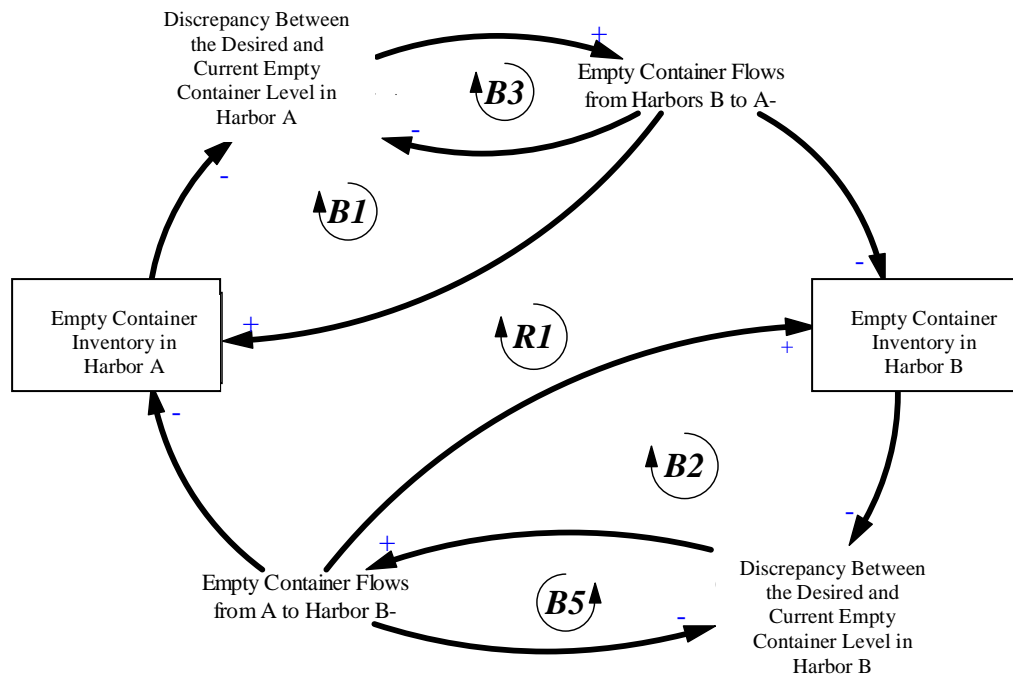
The net container flow is calculated according to the volume of the container arrivals and departures; i.e. the net flow is calculated according to the volume of the empty containers transported from the inland, the volume of the empty and full container arrivals from the other harbors and the volume of the full and empty container shipments from the harbor. It would be



better to underline that the full containers shipped from the other harbors and arrived at the destination harbor cannot be used at once when they arrive at the destination harbor.

Each harbor is sending demand for empty container transportation to the warehouses in the inland according to the discrepancy between the desired and current level of the empty container inventory level in the harbor. The volume of the empty containers transported from the inland is not enough to close the gap between the desired and current empty container inventory level in the harbor, demand for empty container shipments is sent to the other harbors. The gap between the desired and the current empty container inventory level which cannot be closed by the inland empty container supply is the origin of the empty container movements and flows between the harbors.

Moreover, empty container flows are reducing the profit; therefore empty container flows are regarded as a problem. **Figure – 4.2** depicts the origin of the empty container flow problem as a *CLD*. Although there are three harbors in the reference scenario, the origin of the empty container problem is simplified and depicted by containers flowing between two harbors.

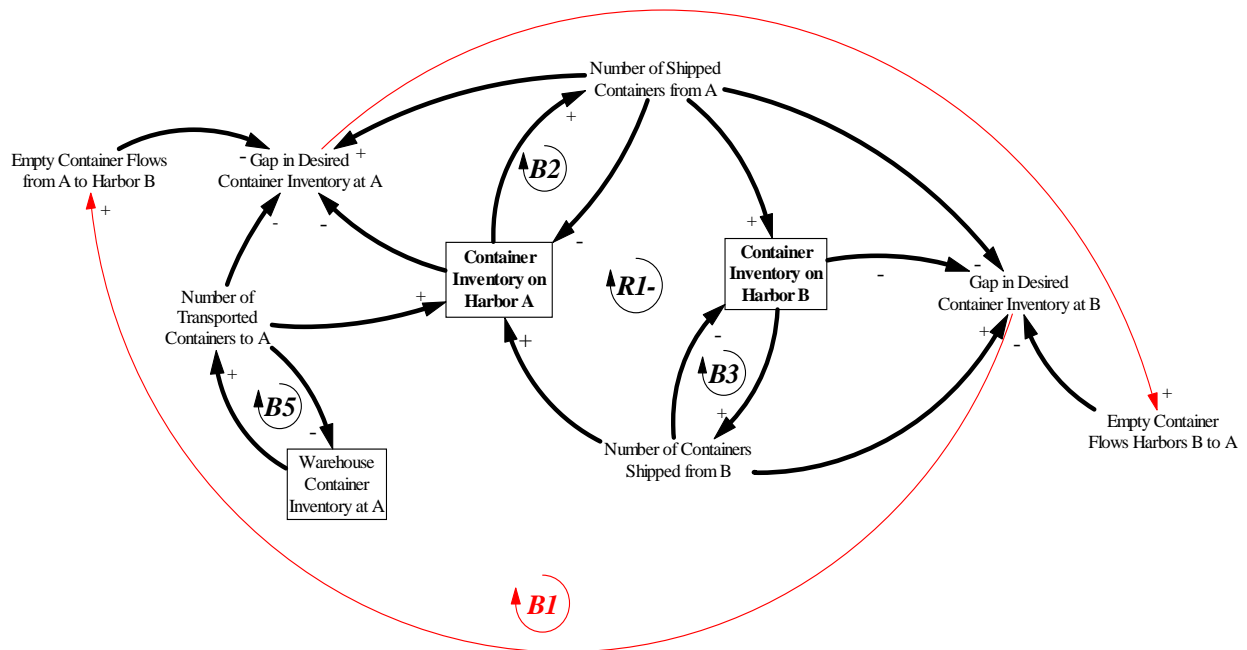


**Figure – 4.2**  
*Origin of the Empty Container Flows*

The discrepancy between the desired and the current empty container inventory level at A increases, the volume of the empty containers shipped from harbor B increases. The volume of the empty containers shipped from harbor B increases, the discrepancy between the desired and

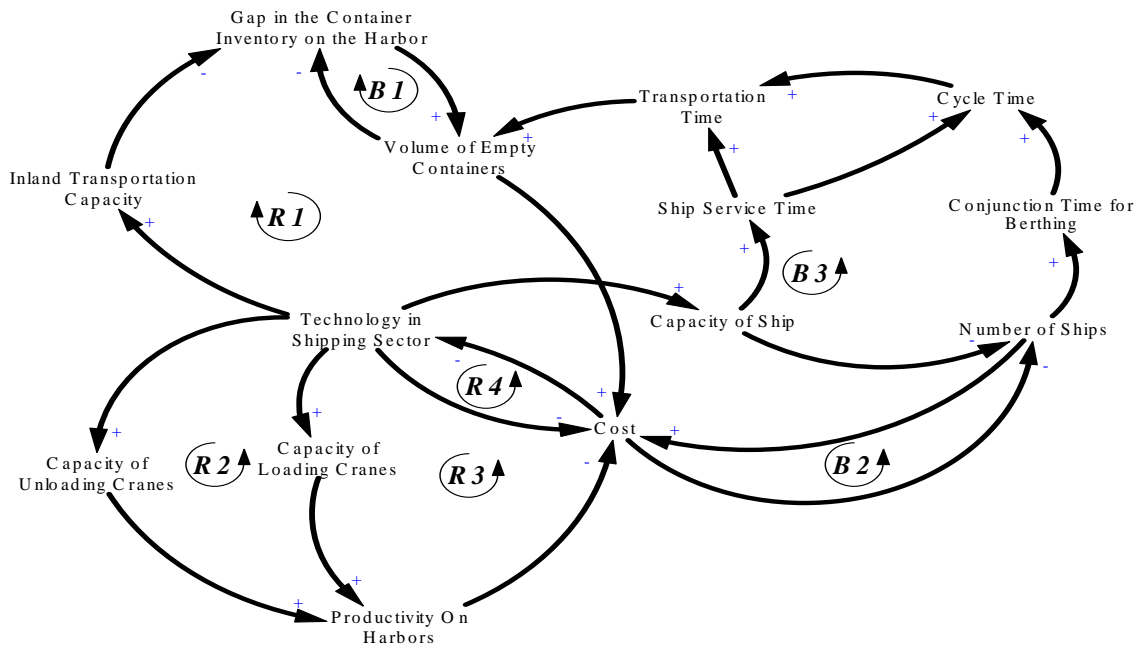
the current empty container inventory level at A declines. This causality creates a balancing loop at harbor A. The discrepancy between the desired and current empty container inventory level at B increases, the volume of the empty containers shipped from harbor A increases. The volume of the empty containers shipped from harbor A increases, the discrepancy between the desired and the current empty container inventory level at B declines. This causality creates a balancing loop at harbor B.

The empty container inventory level at A increases, the discrepancy between the desired and the current empty container inventory level at A declines. The discrepancy between the desired and the current empty container inventory level at A declines, the volume of the empty container flows from harbor B to A declines. The volume of the empty container flows from harbor B to A declines, the empty container inventory level at B increases. The empty container inventory level at B increases, the discrepancy between the desired and current empty container inventory level at B declines. The discrepancy between the desired and current empty container inventory level at B declines, the volume of the empty containers shipped from harbor A declines. The volume of the empty containers shipped from harbor A declines, the empty container inventory level at A increases. This causality creates a reinforcing loop in the system. The empty container flows are the outcome of these two balancing and reinforcing loops.



**Figure – 4.3**  
*CLD on Figure – 4.3 Wider Picture of the Empty Container Problem.*

**Figure – 4.3** gives a broader aspect to evaluate the empty container movements. The empty container inventory of warehouse A and the volume of the empty containers transported from the inland are included. The more the containers from the warehouses transported, the less the gap between the desired and the current empty container inventory level is.



**Figure – 4.4**  
*Factors Affecting the Empty Container Flows*

**Figure – 4.4** shows the causality between the other factors and the empty container flows. The technology increases, new methods and new equipments are developed and these new techniques increase the loading/unloading capacity in the harbors. Increase in capacities renders the harbors more productive. More productive harbors reduce the transportation costs; the costs decline, the income of the harbors increases; therefore more money can be invested on new technology.

Technology increases, ships having bigger transportation capacities are designed. The increase in ocean carrier’s capacity decreases the number of the ships. Instead of owning ships having small carrying capacities, the ship owners prefer to own ocean carriers having bigger carrying capacities.

Before berthing, each ship has to wait for the other ship sailing. It is called berthing conjunction time. The average waiting time is assumed to be 1400 hours annually (Alderton, 2005, p.135). “In 1992 at Singapore the average containership wait for berth was 2.3 hours”. (Alderton, 2005, p.198). The more the number of the ships berthing and sailing are, the more difficult to control

the shipping network is. Therefore, the number of the ships in the system increases, the berthing conjunction time increases. Berthing conjunction time increases, the ships wait more to berth and concomitantly the transportation time increases. Transportation time increases, it takes more time to supply the harbors with containers; thus, the volume of empty container flows increases. The increased volume of empty containers increases the costs. The costs increase, fewer ships for transportation can be afforded.

#### 4.2 Model Boundaries

*Figure – 4.5* shows the boundary of the model.

<i>EXCLUDED</i>	<i>EXOGENOUS</i>	<i>INDOGENOUS</i>
<ul style="list-style-type: none"> <li>* Berthing Conjunction Time</li> <li>* Total Number of Ocean Carriers</li> <li>* Profit</li> <li>* Labor</li> <li>* Transportation Costs</li> <li>* Investment in Technology</li> <li>* Ship Service Time</li> </ul>	<ul style="list-style-type: none"> <li>* Demand</li> </ul>	<ul style="list-style-type: none"> <li>* Container Inventories</li> <li>* Inland Transportation Capacities</li> <li>* Empty Container Flows</li> <li>* Loading/Unloading Crane Capacity</li> <li>* Ocean Carrier Capacity</li> <li>* Container Cycle Time</li> <li>* Productivity of Harbor</li> <li>* Container Cycle Time</li> <li>* Idle Container Ratio</li> <li>* Occupancy Ratio</li> </ul>

*Figure – 4.5*  
*Model Boundary*

### 4.3 The Methodology Used for Creating the Reference Scenario

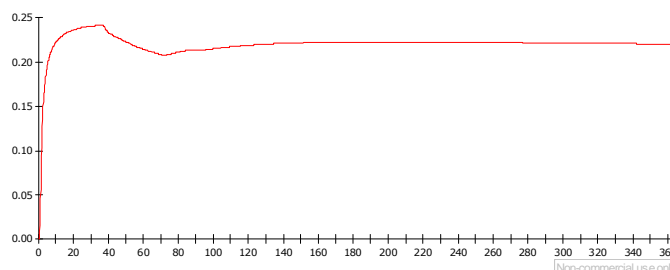
The methodology how the reference scenario is created is explained here briefly. A detailed explanation about reference scenario is done in *Chapter – 5. (See Chapter - 5, part 5.2).*

Three harbors sending empty and full containers are created as a scenario. All the loading/unloading crane structure, the empty container inventories, harbor operations, inland transportation facilities, warehousing operations, container management planning facilities are defined and formulated and a model is built according to these formulations.

Previously it was mentioned that the empty container flows and high idle container level were the main problems of the container logistics. The model is put into equilibrium and it is assumed that in equilibrium the system is in its most desired condition; therefore there is no empty container flow in the equilibrium. Moreover, historical data is collected about the volume of the empty container flows and the idle container level. In *Chapter - 2* it was given that the empty container movements constitute 20% of all the container movements on average. *Figure – 2.2* shows the historical data of the volume of the empty container movements. As for the idle container level problem, historical data shows that 40 - 50 % of the containers are idle during their life time; i.e. each container’s productivity is around 50- 60% in general.

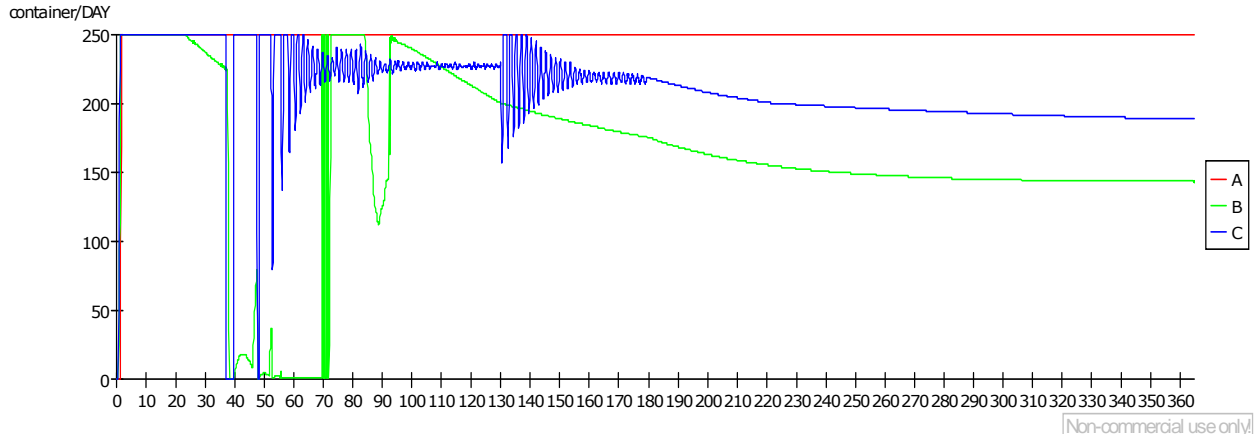
The demand for freight transportation in equilibrium is increased until the model creates 20% empty container volume and 40-50% idle container ratio. The condition that the model is generating 20% empty container volume and 40% idle container level is accepted as reference scenario.

*Figure – 4.6* shows the average empty container volume generated by the model in reference scenario. Compared to the graph depicting the historical data of the empty container volumes on *Figure – 2.2*, *Figure – 4.6* shows that the model is generating empty container flows in the amount that is compatible to the historical data.

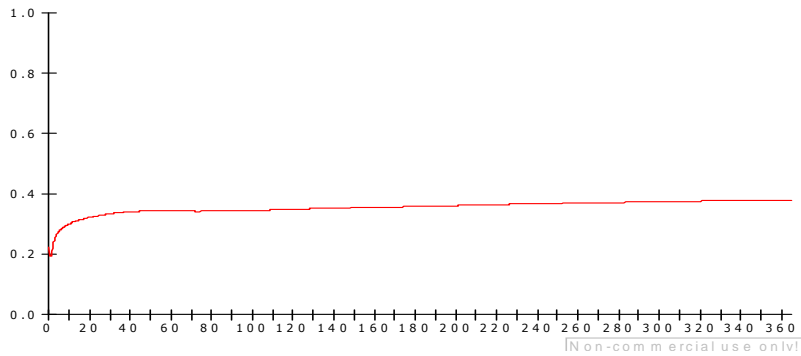


**Figure – 4.6**  
**Average Empty Container Ratio in the Model.**

**Figure – 4.7** depicts the number of empty containers shipped by each harbor in reference scenario. **Figure – 4.7** is calculated according to the average volume of the empty containers shipped from the harbors.



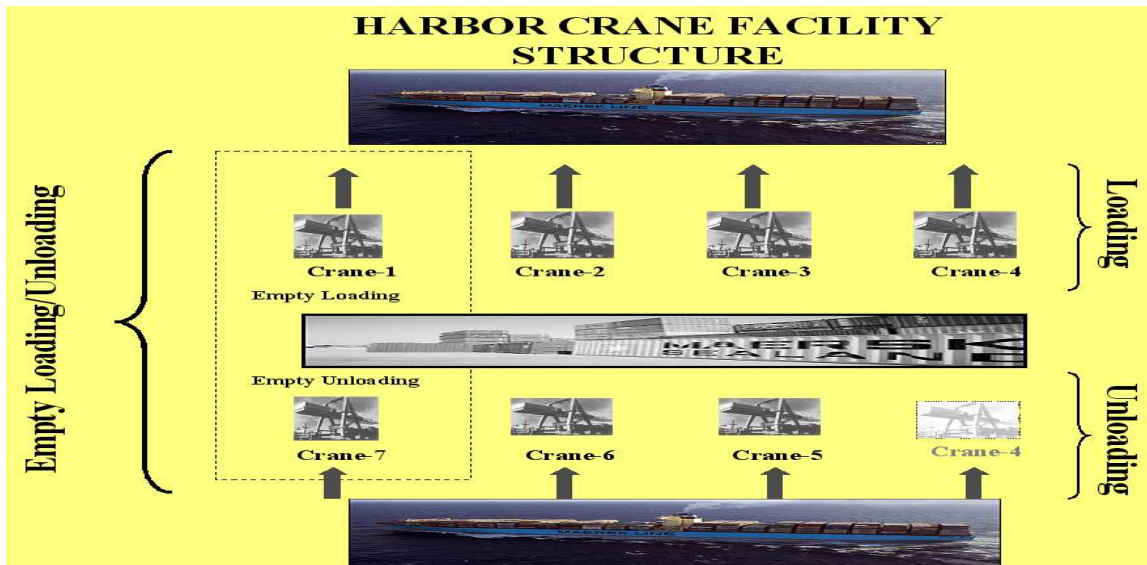
**Figure – 4.7**  
**Volume of Empty Containers Shipped from Each Harbor in Reference Scenario**



**Figure – 4.8**  
**Average Idle Container Ratio in Reference Scenario**

**Figure – 4.8** shows the idle container level in the scenario. Compared to the historical data, **Figure – 4.8** shows that the idle level of the containers in the reference scenario is compatible to the historical data of 40 – 50% idle container level.

#### 4.4 General Information About the Harbor And Transportation Structure in the Scenario



**Figure - 4.9**

##### *Crane Installation Structure of the Harbors in the Reference Scenario*

A container shipping company facilitating between three different lands and harbors was simulated. Three different harbors, three different inland facilities are compounded to the simulation model. A container shipping company which has almost identical structural features in three different lands was created for this study. It is concluded that creating a company that facilitating between three different lands, having equal distances between three harbors, having identical loading/unloading capacities in each harbor, yet having low productive profile is the most propitious way to demonstrate the internal dynamics of the container logistics system.

#### 4.4.1 Inland Transportation Modes and Inland Transportation Capacity Features

Inland Transportation Modes						
Barge (10 Days)		Rail (6 Days)		Truck (3 Days)		
	From Harbors to Warehouses	From Warehouses to Harbors	From Harbors to Warehouses	From Warehouses to Harbors	From Harbors to Warehouses	From Warehouses to Harbors
<b>A</b>	62 Containers per Day	62 Containers per Day	305 Containers per Day	105 Containers per Day	209 Containers per Day	209 Containers per Day
<b>B</b>	162 Containers per Day	62 Containers per Day	105 Containers per Day	105 Containers per Day	209 Containers per Day	209 Containers per Day
<b>C</b>	62 Containers per Day	62 Containers per Day	105 Containers per Day	105 Containers per Day	209 Containers per Day	209 Containers per Day

**Figure - 4.10**

##### *Inland Transportation Times and Inland Transportation Capacities*

On all the lands of A, B and C, the inland transportation is fulfilled by three 3 different transportation modes. The containers arrived at the destination harbor are transported to the inland by rail, by barge and by truck. Transportation by barge between the harbors and warehouses is 10 days on A, B and C. Transportation by is 3 days between all the harbors and warehouses at A, B and C. Transportation time by train is 6 days at A,B and C.

*Figure – 4.10* shows the transportation capacities.

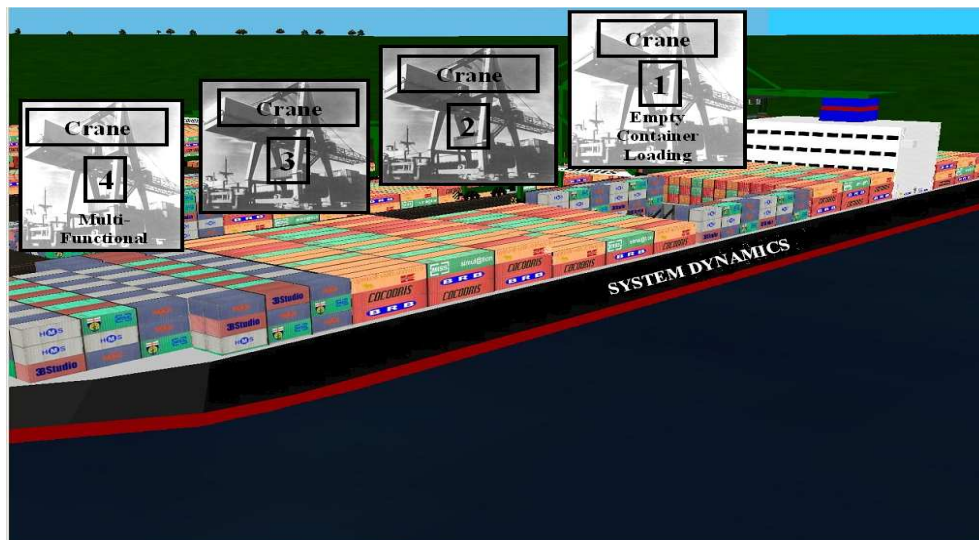
#### ***4.4.2 Crane Installation Structure and Capacity Features***

The operations in the harbors are classified as: loading and unloading container operations. Besides, each loading and unloading operation can be classified according to empty container flows and full container flows as well. Thus; four main operations are taking place in all the harbors.

- Full Container Loading Operations
- Empty Container Loading Operations
- Full Container Unloading Operations
- Empty Container Unloading Operations

#### ***4.4.3 Container Loading Structure in the Harbors***

##### ***Hatch-1***



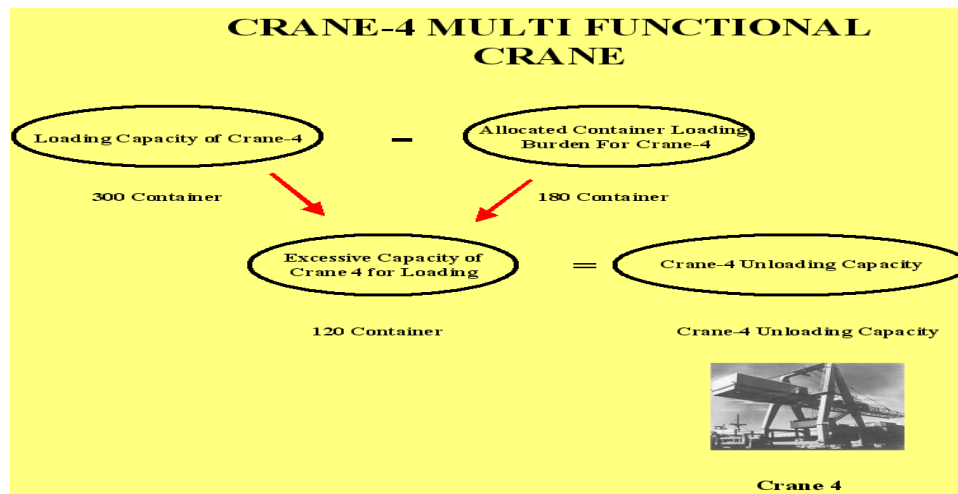
***Figure - 4.11***  
***Container Loading Structure of the Harbors***



There are two main hatches in each harbor in the scenario. In two main hatches there are seven cranes installed. Hatch-1 is used for loading operations and Hatch-2 is used for unloading operations. *Figure - 4.11* depicts the installation of the cranes used for loading operations in Hatch-1. *Figure - 4.12* shows that all the capacity and utilization techniques are identical in the harbors. The cranes are numbered and labeled as C1A, C2A, C3A and etc...C1A stands for the 1<sup>st</sup> crane in harbor A, C3A stands for the 3<sup>rd</sup> crane in harbor A. Four of the cranes are mainly allocated for loading operations and three of them are allocated for unloading operations. Crane-1 is the crane used for empty container loading operations in the harbors. Its unloading/loading capacity is 250 containers per day. Crane-2, Crane-3 and Crane-4 Loading are allocated for full container loading operations. In all the three harbors, the loading/unloading capacity of Crane-2 and Crane-3 is 250 containers per day. *Figure - 4.12* shows the loading/unloading capacities of the cranes in the harbors. The total container loading capacity is 1000 containers per day.

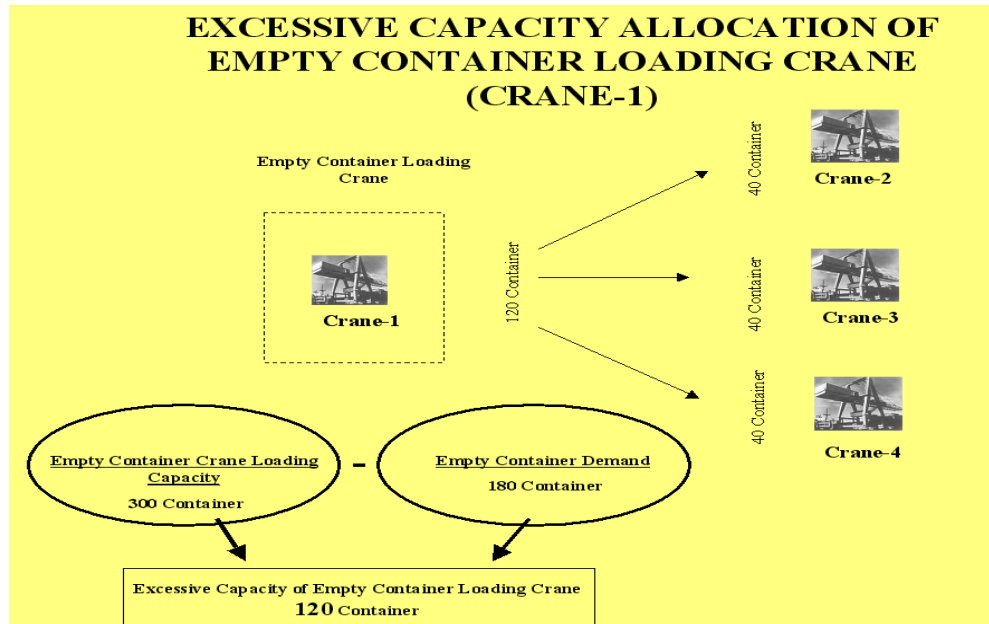
	Crane -1 Loading	Crane -2 Loading	Crane -3 Loading	Crane -4 Loading	Crane -5 Unloading	Crane -6 Unloading	Crane -7 Unloading	Total Loading Capacity per Harbor	Total Unloading Capacity per Harbor
<b>A</b>	C1A 250 Container per Dav	C2A 250 Container per Dav	C3A 250 Container per Dav	C4A 250 Container per Dav	C5A 250 Container per Dav	C6A 250 Container per Dav	C7A 250 Container per Dav	1000 Container Per Day	750 Container Per Day
<b>B</b>	C1B 250 Container per Dav	C2B 250 Container per Dav	C3B 250 Container per Dav	C4B 250 Container per Dav	C5B 250 Container per Dav	C6B 250 Container per Dav	C7B 250 Container per Dav	1000 Container Per Day	750 Container Per Day
<b>C</b>	C1C 250 Container per Dav	C2C 250 Container per Dav	C3C 250 Container per Dav	C4C 250 Container per Dav	C5C 250 Container per Dav	C6C 250 Container per Dav	C7C 250 Container per Dav	1000 Container Per Day	750 Container Per Day

*Figure - 4.12*  
*Daily Capacities of the Cranes in the Harbors*



*Figure - 4.13*  
*Multi-Functional Crane-4*

As represented on **Figure - 4.13** Crane-4 is a multi-functional crane and is used for both loading and unloading operations. Its capacity is shared between the loading and unloading facilities. Therefore, Crane-4 is named as “Crane-4 Loading” and “Crane-4 Unloading”. There is excessive capacity of loading operations for Crane-4, Crane-4 is appointed as Crane-4 Unloading and it is assisting in the unloading operations if there is a gap in the unloading capacity. Crane-4 Unloading can be defined as the excessive loading capacity of Crane-4 Loading.



**Figure - 4.14**  
**Crane - 1**

The volume of the demand for empty container transportation is smaller than the daily empty container loading capacity of Crane-1 (250 containers per day), the excessive capacity of Crane-1 is utilized for full container loading operations. As showed on **Figure - 4.14**, Crane-1 alleviates the burden of each full container loading cranes of Crane-2, Crane-3 and Crane-4 Loading. Even though it seems as the excessive capacity of Crane-1 is utilized by each full container loading crane, this extra job is fulfilled by Crane-1. The total freight loaded/unloaded by each crane is used while calculating the productivity of the harbor. (See **Chapter – 4, part 4.6.8**) While calculating the total weight or freight loaded/unloaded by each crane, this extra capacity which is utilized from Crane-1 is subtracted from the total throughput loaded by each loading crane utilizing the excessive capacity of Crane-1, and is added to the total freight loaded/unloaded by the Crane-1.

#### 4.4.4 Container Unloading Structure in the Harbors

##### Hatch-2

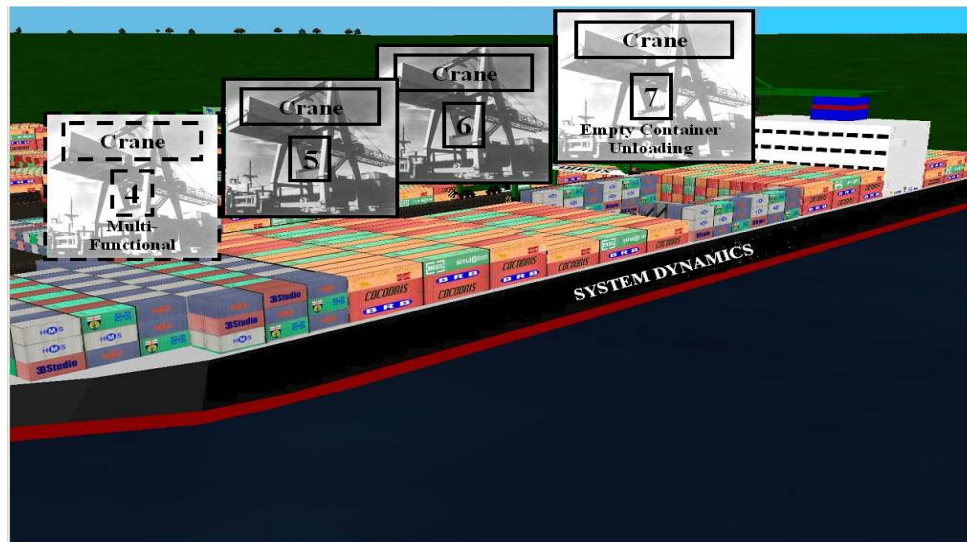


Figure - 4.15  
Container Unloading Structure of the Harbors

Figure - 4.15 depicts the unloading cranes' installation. Crane-4 Unloading, Crane-5, Crane-6 and Crane-7 are used for unloading operations. Crane-7 is allocated for empty container unloading operations. Crane-5, Crane-6 and Crane-7 have an unloading capacity of 250 containers per day. The total container unloading capacity is 750 containers per day.

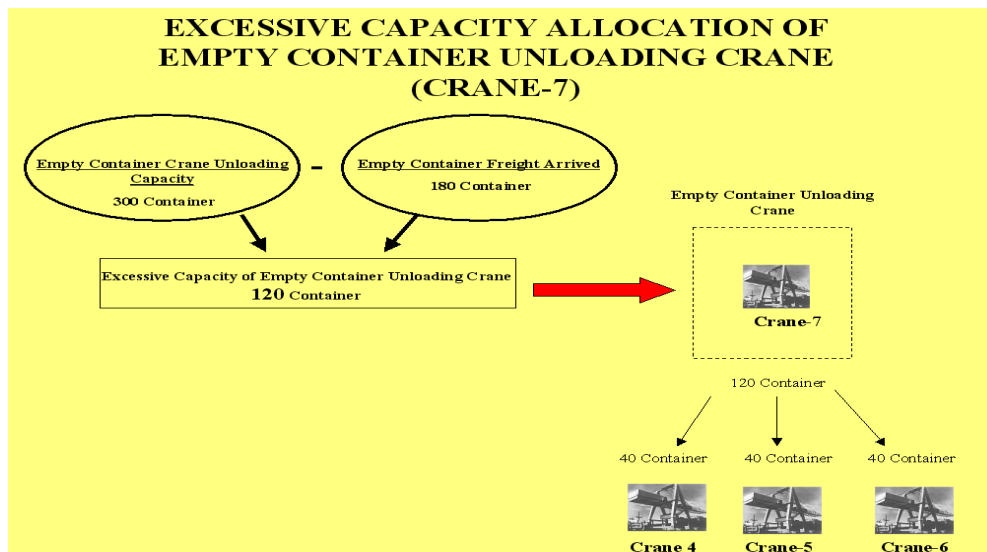


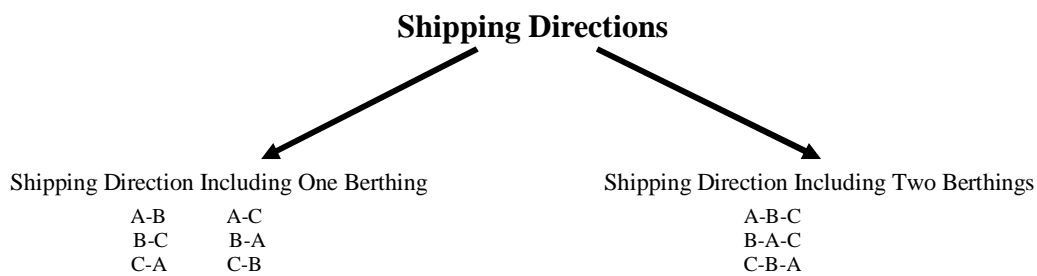
Figure - 4.16  
Crane - 7

The excessive capacity utilization is illustrated on Figure - 4.16. For instance, if Crane-7's capacity is 300 containers per day and if the number of the empty containers arrived at the harbor

is 180 containers, an excessive capacity of 120 containers occurs. The number of empty containers arrived is smaller than the unloading capacity of Crane-7, the excessive capacity is utilized by each full container unloading cranes of Crane-4 Unloading, Crane-5 and Crane-6.

#### 4.4.5 Container Transportation Routes between the Harbors

The shipping routes are classified according to the number of the berthings that the ship does between the origin harbor and destination harbor. *Figure - 4.17* shows the classification of the shipping routes.

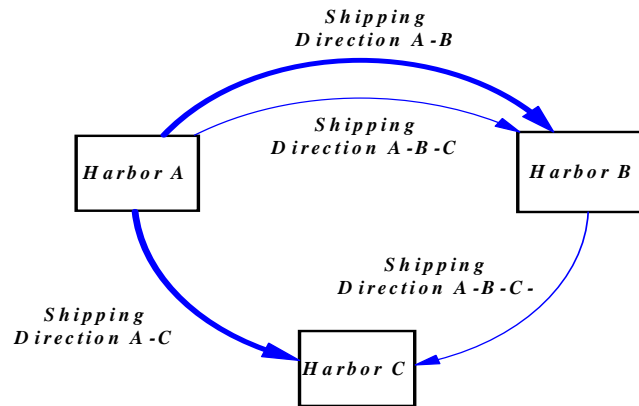


*Figure - 4.17*  
*Shipping Directions According to the Number of Berthings*

Nine main shipping directions originating from harbor A, harbor B and Harbor C are designed for the reference scenario. Moreover, each harbor has priorities for supplying another harbor; therefore priorities are generated for each shipping direction in each harbor. (See *Figure - 4.63*)

	<u>1<sup>st</sup> Priority</u>	<u>2<sup>nd</sup> Priority</u>	<u>3<sup>rd</sup> Priority</u>
□ Shipping Directions Originating from harbor A:	A-C,	A-B,	A-B-C
□ Shipping Directions Originating from harbor B:	B-C,	B-A,	B-A-C
□ Shipping Directions Originating from harbor C:	C-A,	C-B,	C-B-A

#### 4.4.5.1 Shipping Directions From Harbor A



**Figure – 4.18**  
**Shipping Directions from Harbor A**

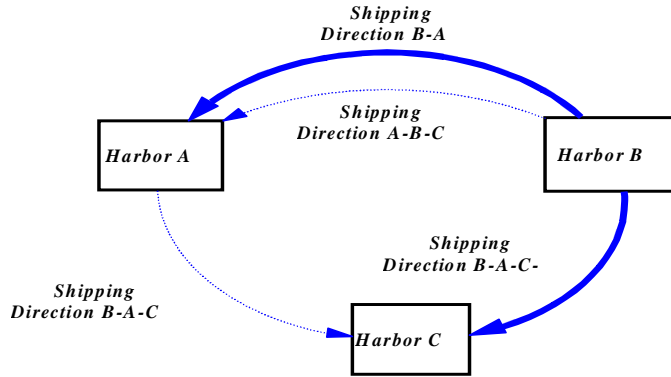
**Figure - 4.18** depicts the shipping routes from harbor A. Three main networks from harbor A are: direct A-B Route, direct A-C Route and A-B-C Route. Two of the routes originate from harbor A: route A-B and route A-B-C. Route direct A-C originates from harbor B. A-B depicts the departure and arrival of the transportation locations, i.e. departure from harbor A and arrival at harbor B. The containers loaded to the ship in harbor A are transported directly to harbor B.

Route A-C is the continuation of route B-A-C. As mentioned previously, it originates from harbor B. The ship sails from harbor B by loading the freight to the destination harbor of C. After sailing from harbor B the ship berths at harbor A and without unloading any containers, the demand from harbor A to harbor C (Demand for transportation for A-C direction) is loaded. Loading at harbor A for A-C direction is constricted by the remaining capacity of the ship loaded at harbor B. The ship was loaded previously in harbor B for the route B-A-C; the maximum amount that can be loaded to the ship for route A-C is the remaining capacity of the ship after being loaded at harbor B for route B-A-C. (See 4.6.4, **MODULE-4 Ship Capacity Effect on Full Container Loading Planning**)

Route A-B-C originates from harbor A. In harbor A the demand for transportation is received, the number of the containers for the transportation is calculated, the freight is loaded and the containers are shipped to harbor C. After sailing, the ship berths at harbor B. In harbor B, the demand for transportation from B to harbor C is loaded according to the remaining ship capacity factors.

Route direct A-C can be regarded as an express transportation of route A-B-C. The transportation time from harbor to harbor takes 17 days by route A-C while the transportation takes 34 days by route A-B-C.

#### 4.4.5.2 Shipping Directions from Harbor B

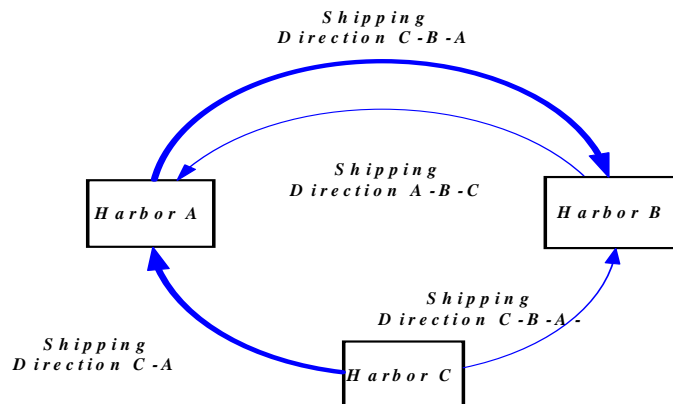


**Figure - 4.19**  
*Shipping Directions from Harbor B*

**Figure - 4.19** depicts the routes from harbor B. Three main routes are designed from harbor B: direct B-A route, direct B-C route and B-A-C route. While route B-A-C originates from harbor B, route B-A and route B-C are not originating from B. Route B-A is the continuation of route C-B-A. Route B-A originates from harbor C. Route B-C is the continuation of A-B-C route, and originates from harbor A.

B-C route is an express or fast alternative for the route of B-A-C.

#### 4.4.5.3 Shipping Directions from Harbor C



**Figure - 4.20**  
*Shipping Directions from Harbor C*

*Figure - 4.20* depicts the transportation routes from harbor C. Three main networks are designed in harbor C: C-A route, C-B and C-B-A directions. Three of the routes are originating from harbor C.

#### ***4.4.6 One Container Cycle***

The container is waiting idle and empty in the harbor container terminal in time ZERO. The company receives the demand for freight transportation, the planning facilities begin, the number of the containers required for the freight transportation is decided and then the containers are being filled at the filling stations. In the reference scenario, there are 10 filling stations on each harbor and filling each container takes 0.01388889 day; i.e. it takes 20 minutes to stuff a container. The filling stations' total filling capacity on each harbor is 2,160 containers per day. The container stuffing operations are done, the full containers are loaded to the ship with the loading cranes. The containers stuffed, wait in the ship until the ship is full; therefore the ship carrying capacity has an effect on the waiting time in the harbors. The ship is full, the containers are shipped to the destination harbor. As mentioned previously, the transportation time by ship between the harbors is 17 days equally. The containers arrived at the destination harbor, the unloading and discharging operations begin. It is assumed that on the arrival of the containers, the ships directly berth and right after the discharging operations begin; i.e. it is deemed that the pre-berthing time is ZERO and there is no conjunction in berthing with the other ships. Arriving at the harbor the ship berths and the unloading operations begin.

Containers arriving at the destination harbors are transported directly to the inland. The deliveries in the harbor site are neglected in this study. The containers arrived at the warehouses are taken over by the clients. It is assumed that a client can keep a container delivered to him for 4 days. In each inland, it is assumed that the company has 50 constant clients to whom 10 containers are delivered per day; i.e. it is assumed that the warehouses in the inlands has a 500 container delivery capacity per day. On each land, an interchange or leasing site is installed. There is need for container to lease, it takes 1 day to receive the leased. Besides the leasing and interchanging locations, a disposal and new container buying site is installed on land C. It is assumed that everyday 73 containers are filling their life span and are disposed from the land C. Besides, it is assumed that 73 containers are in the need to be repaired daily. All the containers filling their life span and all the containers in the need of repair are transported to the land C. On land C, newly

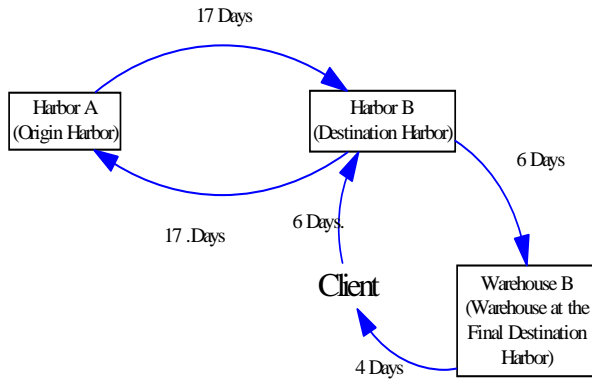
bought containers are entering into the system. The empty containers shipped from the harbors are not transported to the inland. They are unloaded on the destination harbors, they directly join the empty container inventory of the destination harbor. An empty container loaded, completes its cycle by flowing from the origin harbor to the destination harbor and flowing back to its origin harbor. Arriving at the destination harbor a full container goes on its journey to the inland of the destination harbor land. Then the container goes on flowing from the destination harbor to the warehouses and then back to the destination harbors. From the destination harbor, the container is sent back to the origin harbor. Arriving at the origin harbor the container completes its cycle.

The shipping route may include one or two berthings. (*See Figure – 4.21* and *Figure - 4.22*) For instance, the containers sent to A-B, C-A, B-A directions include just one berthing on the destination harbors. But the containers sent to A-B-C, B-A-C or C-A-B directions include two berthings on two different harbors. A container cycle which including just one berthing can be described as a flow between origin harbor-destination harbor-warehouse on the land of destination harbor-destination harbor-origin harbor.

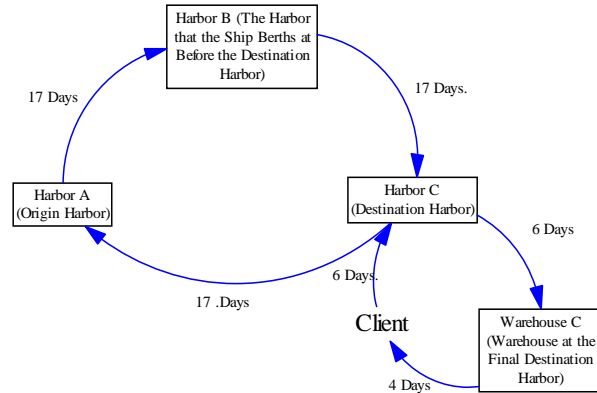
A container cycle in a shipping route including two berthings can be described as a flow between the origin harbor- the harbor the ship berthed before the destination harbor-destination harbor-warehouse on the land of destination harbor-destination harbor-origin harbor. (*See Figure - 4.22*).

While calculating the ratio of idle containers, the average circle time is calculated according to the sort of the shipment including one or two berthings. The full containers sent to the route including one berthing is calculated as: the loaded container transportation time by ship from origin harbor to the destination harbor (17 days) + transportation time from the destination harbor to the warehouse by rail (6 days) + client container keeping time (4 days) + transportation time from warehouse to the destination harbor by rail (6 days) + transportation time from the destination harbor to the origin harbor (17 days). Consequently, the cycle time for the route including one berthing is 50 days. (*See Figure - 4.21*)





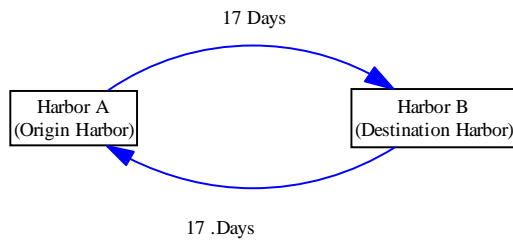
**Figure - 4.21**  
**Container Cycle Time of a Full Container in a Shipping Direction Including One Berthing (A-B-C Shipping Direction)**



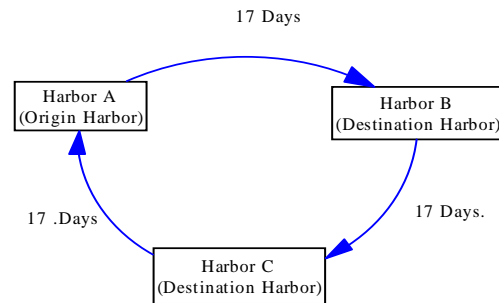
**Figure - 4.22**  
**Container Cycle Time of a Full Container in a Shipping Direction Including two Berthings (A-B-C Shipping Direction)**

There are three inland transportation modes of barge (Inland transportation time is 10 days), rail (Inland transportation time is 6 days), truck (Inland transportation time is 3 days) (See Chapter – 4, 4.4.2). While calculating the average cycle time, the average inland transportation time from the harbors to the warehouses and from the warehouses to the harbors is assumed as 6 days. 6 days is the average value of these three transportation times; thus it is assumed that the freight in inland is transported by train in average.

The cycle time of the full container sent to the route including two berthings (See Figure - 4.21) is calculated as: the transportation time by ship from the origin harbor to the harbor the ship berthed before the destination harbor (17 days) + the transportation time between the harbor the ship berthed before the destination harbor and the destination harbor (17 days) + transportation time from the destination harbor to the warehouse by rail (6 days) + client container keeping time (4 days) + transportation time from warehouse to the destination harbor by rail (6 days) + transportation time from the destination harbor to the origin harbor (17 days). The cycle time for the shipping route including two berthings is calculated as 67 days. But the route requires two berthings in two different lands. Therefore, flexibility around 10% is added for a possible delay. Consequently, the container cycle time for the shipping route including two berthings is calculated as 75 days instead of 67 days.



**Figure - 4.23**  
*Container Cycle Time of an Empty Container in a Shipping Direction Including One Berthing (A-B-C Shipping Direction)*



**Figure - 4.24**  
*Container Cycle Time of an Empty Container in a Shipping Direction Including two Berthings (A-B-C Shipping Direction)*

As for the empty container cycles, an empty container shipment including one berthing is defined as: the flow between the origin harbor-destination harbor- origin harbor. The empty containers are not transported to the inlands. **Figure - 4.23** shows the empty container cycle time of a shipping route including one berthing. It is calculated as: the transportation time between the origin harbor and the destination harbor (17 days)+ Transportation time from the destination harbor of the origin harbor (17 days). Consequently, the cycle time for an empty container requiring one berthing is 34 days.

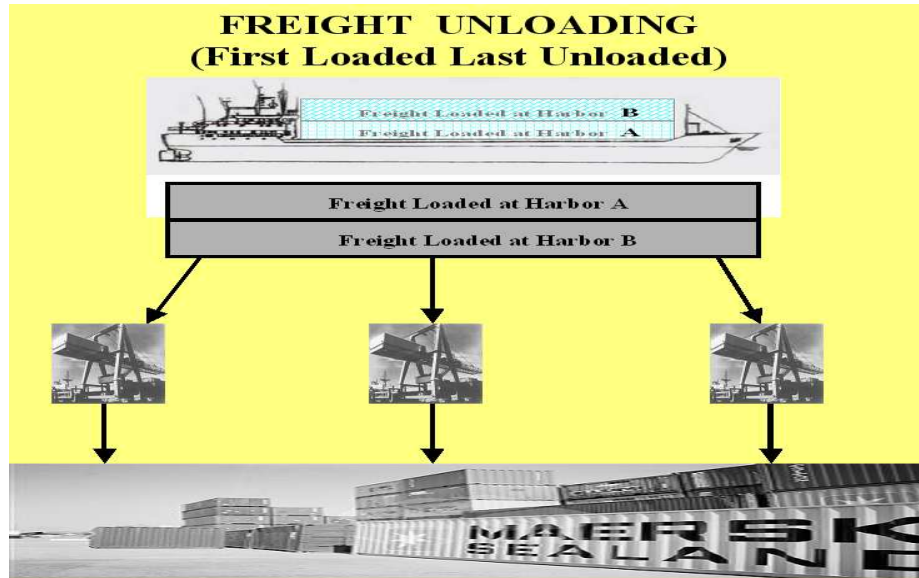
**Figure - 4.23** shows the empty container cycle time of a shipping route including two berthings. An empty container sent to a shipping direction including two berthings is defined as the flow between the origin harbor- the harbor the ship berthed before the destination harbor-destination harbor- origin harbor. The cycle time for empty container shipment including two berthings is calculated as: the transportation time between the origin harbor and the harbor ship berthed before the destination harbor (17 days)+ the transportation time between the harbor the ship berthed before the destination harbor and the destination harbor (17 days) + The transportation time from the destination harbor to the origin harbor (17 days). Consequently, the empty container cycle time for the shipping direction including two berthings is 51 days.

## 4.5 General Assumptions for Loading & Unloading Operations

The model is built based on some assumptions.

### 4.5.1 First Loaded Last Unloaded

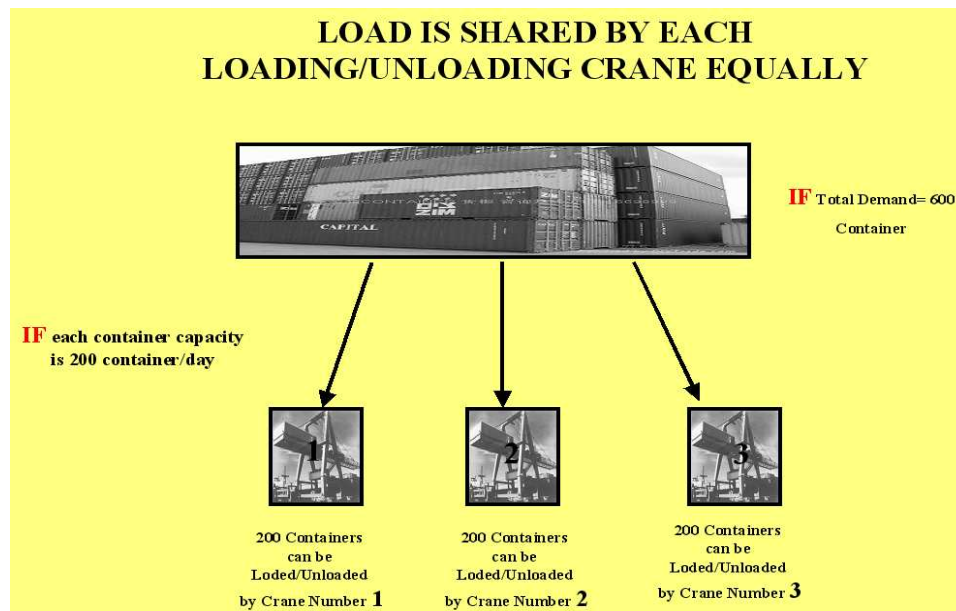
Some assumptions are done to calculate each crane's burden for loading/unloading.



*Figure - 4.25*  
*First Loaded Last Unloaded*

*Figure - 4.25* depicts the assumption that the containers loaded first are unloaded last. For instance, on the route A-B-C, firstly the containers for A-C direction (from harbor A to harbor C) are loaded. Then the ship sails from harbor A and berths at harbor B for loading the demand of freight transportation from harbor B to harbor C (B-C Direction). The containers from harbor B are placed on the containers having been loaded in harbor A. The ship berths at the destination harbor (Harbor C), the last containers loaded in harbor B are on the top side; therefore they are unloaded firstly.

#### 4.5.2 Load Is Shared Among the Loading/Unloading Cranes Equally



*Figure - 4.26*  
*The burden is Shared Equally Among the Cranes*

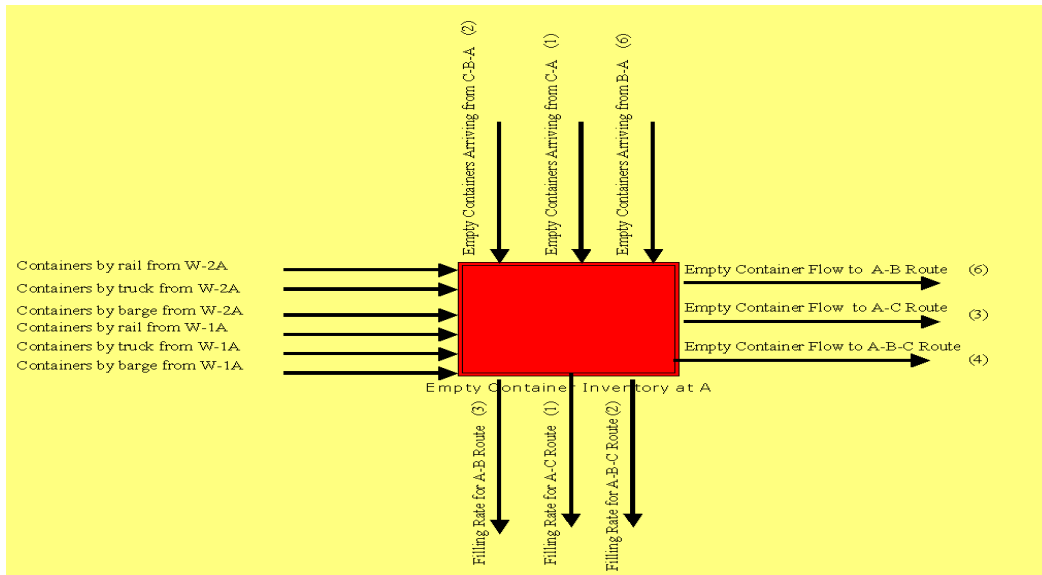
*Figure - 4.26* depicts an example of how the burden is shared among the loading/unloading cranes equally. The example on *Figure - 4.26* shows that if the demand for transportation requires 600 containers and if there are three cranes, each crane's loading/unloading burden is 200 containers. If each crane's loading/unloading capacity is 200 containers, there won't be neither excessive capacity, nor a gap in loading/unloading capacity. Likewise the burden, the excessive loading/unloading capacity and the gap in loading/unloading capacity is shared equally among the cranes as well. Each crane has a 200 container loading/unloading capacity; i.e. if the total loading/unloading capacity is 600 containers, and if the demand for freight transportation requires 450 containers, the total excessive capacity is 150 containers. The excessive capacity is shared equally among the cranes; therefore the excessive capacity of each crane is 50 containers. The main idea is that the loading/unloading cranes have the same capacity, they begin and finish the loading/unloading operations at the same time. In a case of 150 container total excessive loading/unloading capacity; i.e. 50 container excessive capacity for each crane denotes that each crane finishes its job earlier than the scheduled time. If each crane loading/unloading capacity is 200 containers in 24 hours, each crane spends 6 hours for loading/unloading 50 containers. So that, the cranes finish their job 6 hours earlier in a case of 150 containers total excessive loading/unloading capacity. On the other hand, if there is a gap in loading/unloading capacity, the

gap is shared equally by each crane as well. To illustrate, if the demand for freight transportation requires 750 containers, the gap in total loading/unloading capacity is 150 containers. The gap is shared equally among the three cranes; i.e. the gap of each container's loading/unloading capacity is 50 containers, and if each crane's daily loading/unloading capacity is 200 containers, there will be a delay. Each crane spends more time to fulfill the loading/unloading operation. Loading/unloading 50 containers takes 6 hours; therefore the delay is 6 hours and the loading/unloading operation is fulfilled in 24 hours + 6hours (Extra working time for filling the gap) = 30 hours.

### **4.5.3 Stocks**

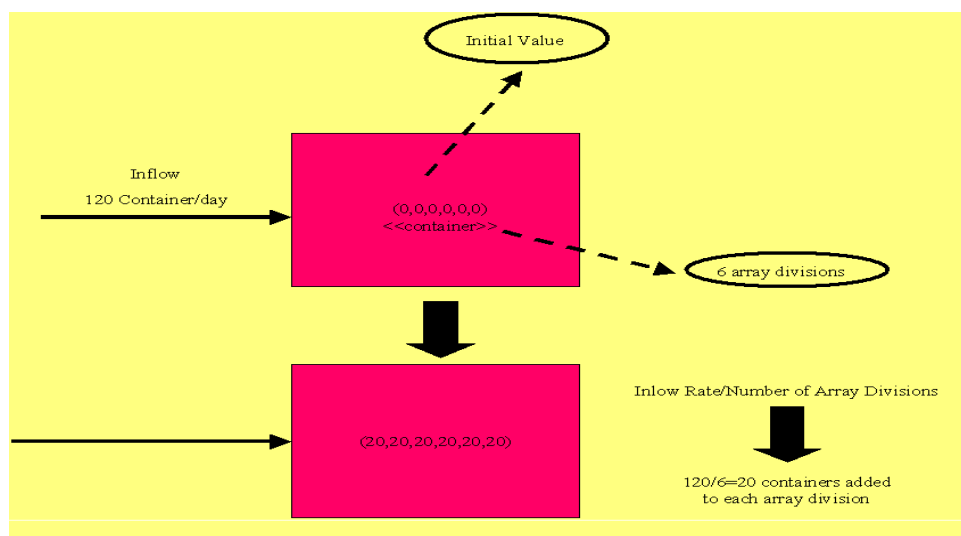
Three main empty container inventories in three different harbors named as A, B, and C are created. Each empty container inventory has 59,375 containers. Distances between the harbors are equal, and from one harbor to the other it takes a 17 day journey by ship. In each land two warehouses are installed and each of them is named as W1 and W2. W1A shows the first warehouse at A, W2C shows the second warehouse on the land C. As mentioned before, a company facilitating in three different lands having almost identical logistics features is built. While compounding more details and putting the model into the equilibrium some of the capacity features are modified. While W1A and W2A initial empty inventory level is 7,125 containers, W1B and W2B initial empty container levels are 7,000 containers. Besides, W1C initial empty container level is 7,000 containers, and W2C initial empty container level is 6,848 containers.

The model is consisted of 11 stocks in each harbor, i.e. 33 stocks in 3 harbors are created. Six types of flows including all the transportation routes with empty and full containers are designed. Therefore six arrays are created on each stock.



**Figure - 4.27**  
**Empty Container Inventory in Harbor A**

**Empty Container Inventory at A:** Empty Container Inventory is shown on **Figure - 4.27**. The initial value of the stock is 59,375 containers. The arrays are installed as {10000, 10000, 9791.66666666667, 9791.66666666667, 10000, and 9791.66666666667}. Six arrays, nine inflows, six outflows are designed. Although the six inflows from warehouses don't have arrays, the other inflows and outflows are designed as arrays. Stock is designed with arrays and if a flow without any arrays is flowing in the stock, this flow is divided by the number of arrays in the stock and is added to each array division in the stock. If it is an outflow, the value is subtracted from each array division in the stock. The situation is exemplified on **Figure - 4.28**



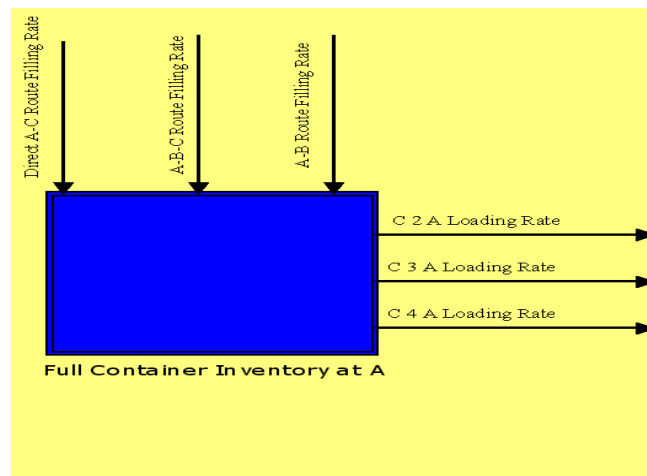
**Figure - 4.28**  
**Arrays, the Inflows and the Outflows**

The example depicted on **Figure - 4.28**. shows that if there is an inflow (120 Containers/Day), and if the stock is designed with arrays (6 Arrays), the inflow is divided by the number of array divisions (6 Arrays), and this amount (20 container/day) is included to each array division on the stock. On the contrary, if there is an outflow, the same calculation is done by subtracting this amount from each array division in the stock.

The planning facility is done, the container stuffing operations begin. “Filling Rate A-B Route”, “Filling Rate A-C Route” and “Filling Rate A-B-C Route” show the filling operations. Moreover, empty containers are sent to the other harbors as well. Empty container loading operations are simulated with empty container flows of A-C, A-B and A-B-C.

Containers from both warehouses at A are arriving according to the desired level of the inventory level. The demand for empty container transportation is sent to the warehouses and the empty containers are transported by three different transportation modes from the warehouses: by rail, by truck and by barge. The desired empty container level in harbor A is 60,000 containers.

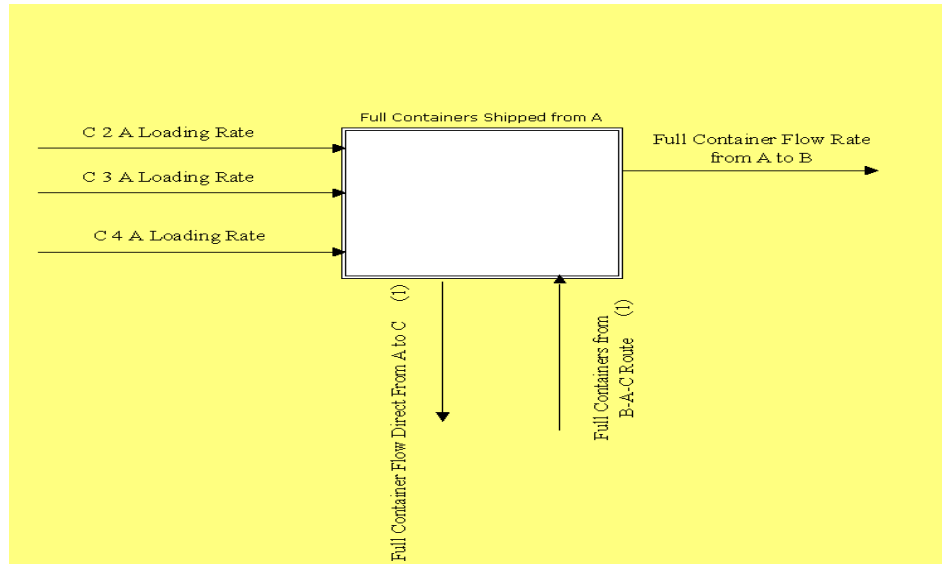
Empty containers from the other harbors are arriving at harbor A. To keep the empty container at the desired level, the daily demand for empty containers shipments is sent to the other harbors. Containers arriving according to this demand are simulated with the flows of empty containers arriving from C-B-A, C-A and B-A.



**Figure - 4.29**  
**Full Container Inventory in Harbor A**

**Full Container Inventory at A:** Full container inventory simulates the containers waiting to be loaded to the ship when the stuffing operation is over. The high level of the inventory gives us hints about the unproductivity of loading operations. As demonstrated on **Figure - 4.29** three

inflows and three outflows are designed. Three inflows denote the filling operations, the outflows simulates the loading operations.



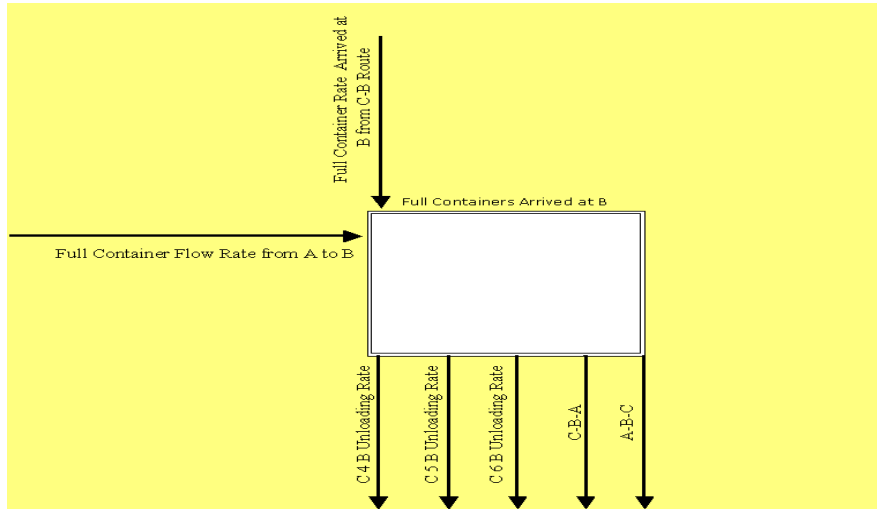
**Figure - 4.30**  
**Full Containers Shipped from Harbor A**

**Full Containers Shipped from A:** This stock is consisted of four inflows and two outflows. This inventory depicts all the full containers shipped in the last 17 days, i.e. it shows all the containers on the way to the destination harbors.

The flow of B-A-C route arrives at A as a full container flow, but harbor A is not the destination harbor of this flow (See 4.4.6.2 *Shipping Directions from Harbor B*); therefore it goes on flowing. This container flow is labeled as number “1” in the array division of the Full Containers Shipped from A. A-C takes number “1” in the array division and labeled as B-A-C as well. Because route A-C is the continuation of the flow of route B-A-C. The ship in harbor B is loaded with the freight for B-A-C direction, the ship sails from harbor B and then berths in harbor A to pick up the freight from harbor A for A-C direction. The loading operation at A is fulfilled according to the remaining capacity of the ship loaded at B for the B-A-C direction.(See 4.6.4, **MODULE-4 Ship Capacity Effect on Full Container Loading Planning**). These two flows cohere and go on flowing as a single flow with the name of “ Full Container Flow Direct from A to C”.

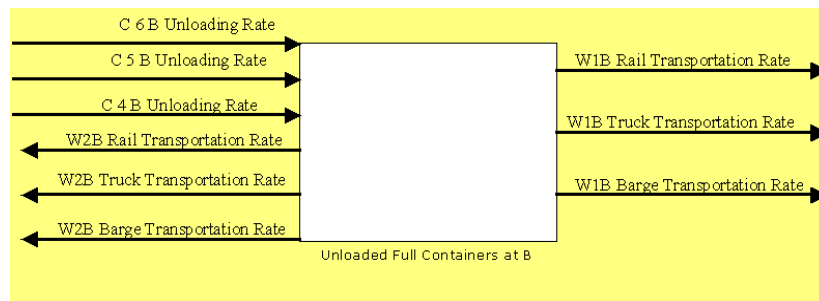
C2A, C3A and C4A cranes are loading the stuffed containers according to the destination harbors. Outflow of “Full Container Rate from A to B” is consisted of two flows: containers sent to Route A-B and Route A-B-C.





**Figure - 4.31**  
**Full Containers Arrived at B**

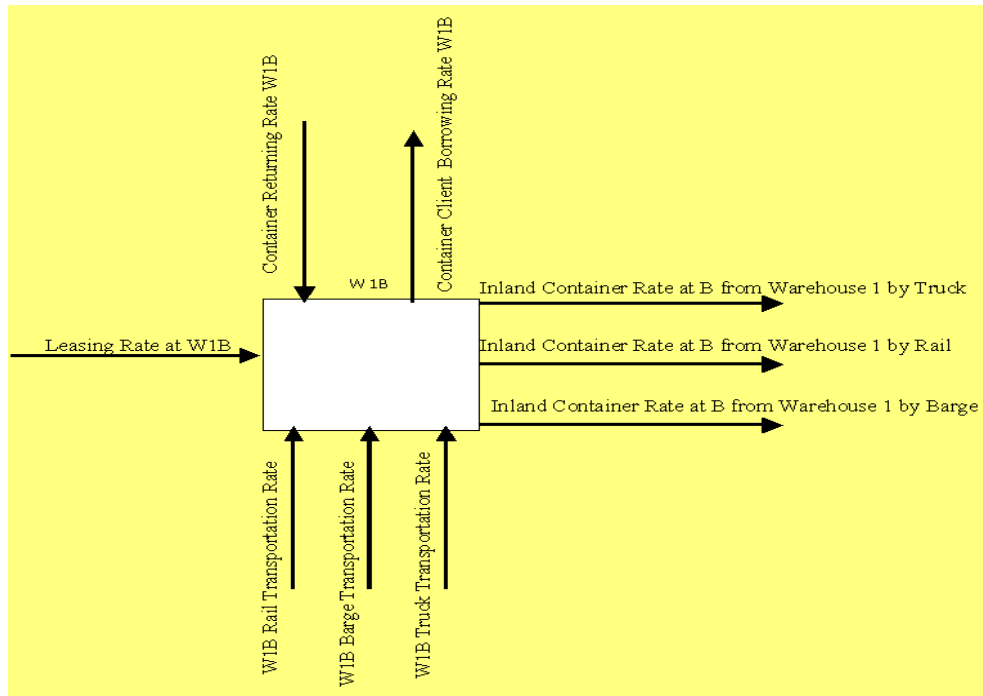
**Full Containers Arrived at B:** As showed on **Figure - 4.31** this stock is consisted of two inflows and five outflows. The flow of “Full Container Flow Rate from A to B” is consisted of two flows: containers flowing from route A-B and A-B-C. Full Container Rate Arrived at B from C-B route is consisted of two flows as well: full containers flowing from C-B route and C-B-A route. The containers arrived at the destination harbors: flow A-B and flow C-B are unloaded by unloading cranes of C4B, C5B and C6B. The flows of A-B-C and C-B-A are going flowing on their routes. These flows are flowing directly to the stock of full shipped containers at B; i.e. the ship carrying these containers berths and without unloading any containers, new containers are loaded for the destination harbor. Therefore these flows are the inflows of “Full Containers Shipped from Harbor B”. They are ready to be shipped but they are waiting at Harbor B for the new containers being loaded for the destination harbor.



**Figure - 4.32**  
**Unloaded Full Containers at B**

**Unloaded Full Containers at B:** **Figure - 4.32** indicates the containers arrived at the destination harbor. This stock is consisted of three inflows and six outflows. The containers unloaded by the

full container unloading cranes of Crane-4 Unloading, Crane-5 and Crane-6 are transported to the inland warehouse inventories to be delivered to the clients. The six outflows are the main transportation directions to the warehouses from harbor B. The transportation to each warehouse is fulfilled by three different transportation modes of transportation by rail, transportation by truck and transportation by barge.

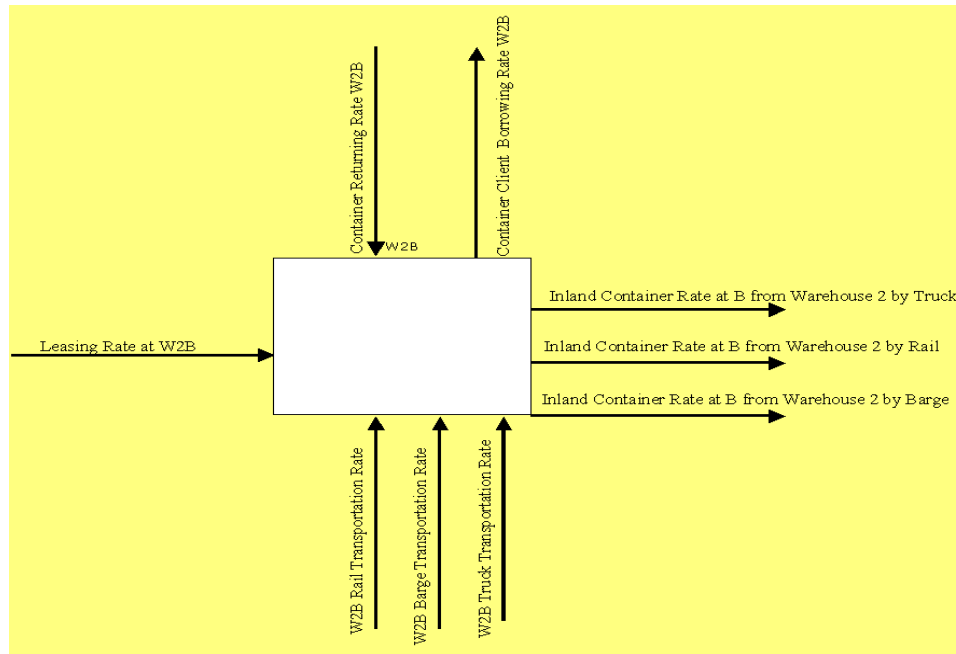


**Figure - 4.33**  
**W1B Warehouse-1 at B**

**W1B:** Figure - 4.33 depicts the inventory level of Warehouse-1 at B. This stock is consisted of five inflows and four outflows. The containers are arriving by rail, by barge and by truck. Each transportation mode has a daily carrying capacity. (See *Figure – 4.10, Inland Transportation Times and Inland Transportation Capacities*). Moreover, the containers are being sent from the warehouses according to the desired level of empty container inventory of B. Each transportation mode’s capacity has constrictions on these flows. A daily demand for empty container transportation is sent to warehouse-1 according to the desired level of the empty container inventory in harbor B. There is a leasing and interchanging site on land B. The desired empty container level is 7,000 containers at warehouse-1B. The volume of the containers transported by barge, by truck and by rail is not enough to keep the empty container inventory at its desired container level, leasing or interchange operations are done at W1B. “Leasing Rate at W1B” simulates this facility. But there is a daily container leasing capacity as well. Not more than 150

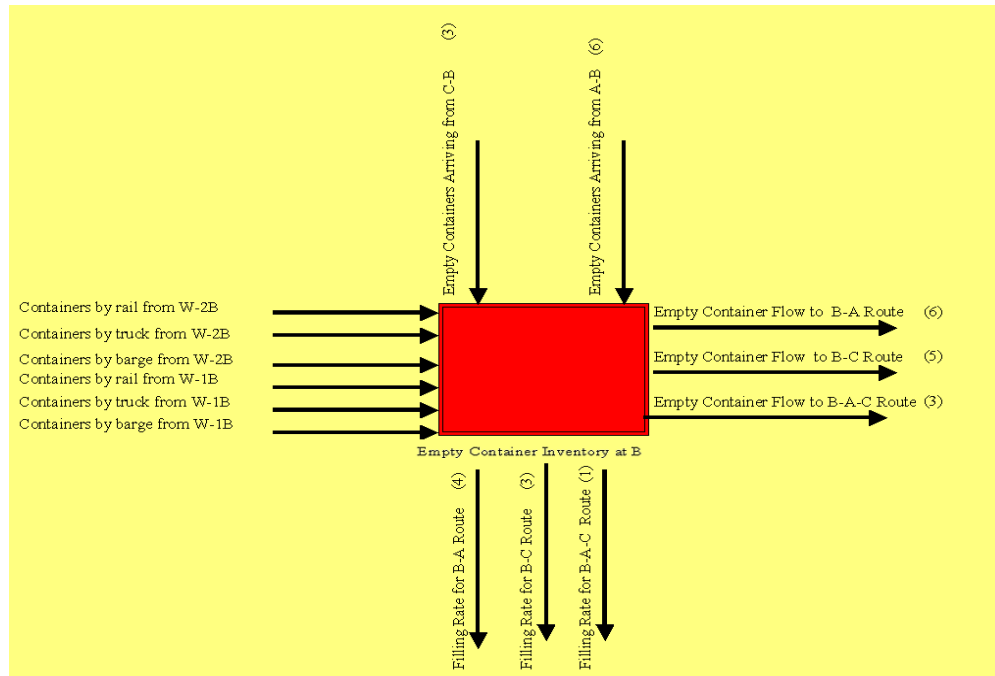
containers per day can be leased or interchanged. When a decision is made for leasing or interchange, it is assumed that this operation is fulfilled in one day.

“Container Client Borrowing Rate” represents the deliveries to the clients in the inland. It is assumed that the company has 10 constant clients to whom 50 containers delivered daily. The client container keeping time is 4 days. “Container Returning Rate” represents the containers being sent back to the company by the clients after the four day container keeping time.



**Figure - 4.34**  
**Warehouse - 2 at B**

**W2B:** *Figure - 4.34* depicts the empty container inventory at warehouse-2 at B. Containers are arriving at the W2B from the harbor B by three different transportation modes. Harbor B sends demand for empty container transportation from W2B and containers are transported from W2B. The volume of the containers transported from W2B is calculated according to the desired empty container inventory level in harbor B. It is assumed that everyday 50 containers are delivered to 10 clients in the inland of B; i.e. the volume of the daily deliveries is 500 containers. Containers are returning back 4 days later after the delivery to the clients.



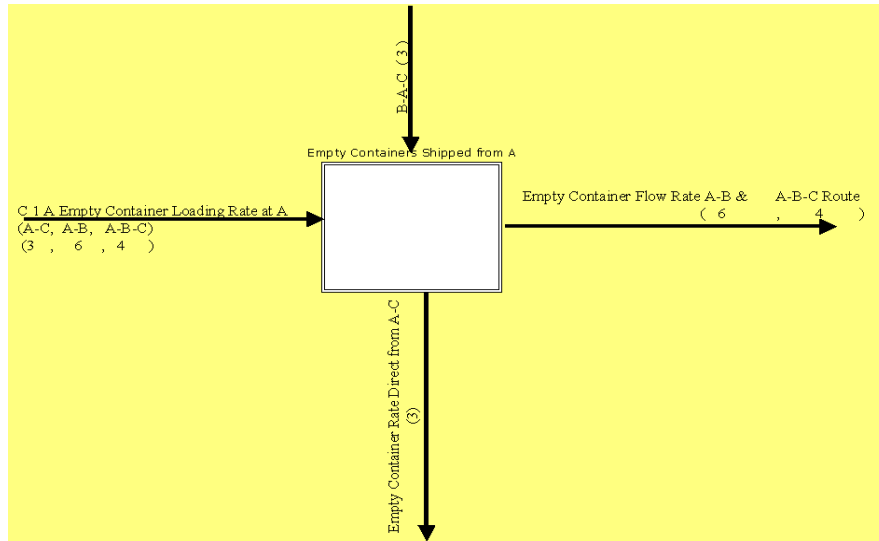
**Figure - 4.35**  
**Empty Container Inventory in Harbor B**

**Empty Container Inventory at B:** Figure - 4.35 depicts the empty container stock in harbor B. The initial level of this stock is 59,375 empty containers. Containers were allocated to each division as: {10000, 10000, 9791.66666666667, 10000, 9791.66666666667, and 9791.666666666670} <<Containers>>.

The desired level of the empty container inventory in harbor B is 60,000 containers. Demand for empty container transportation from the warehouses in the inland is sent to the warehouses to keep the empty container inventory in harbor B at the desired level. Containers are transported from the warehouses by using three different transportation modes of rail, truck and barge. Transportation capacities of each transportation modes constrict the volume of the empty container transportation from the warehouses. (See Figure – 4.10, *Inland Transportation Times and Inland Transportation Capacities*)

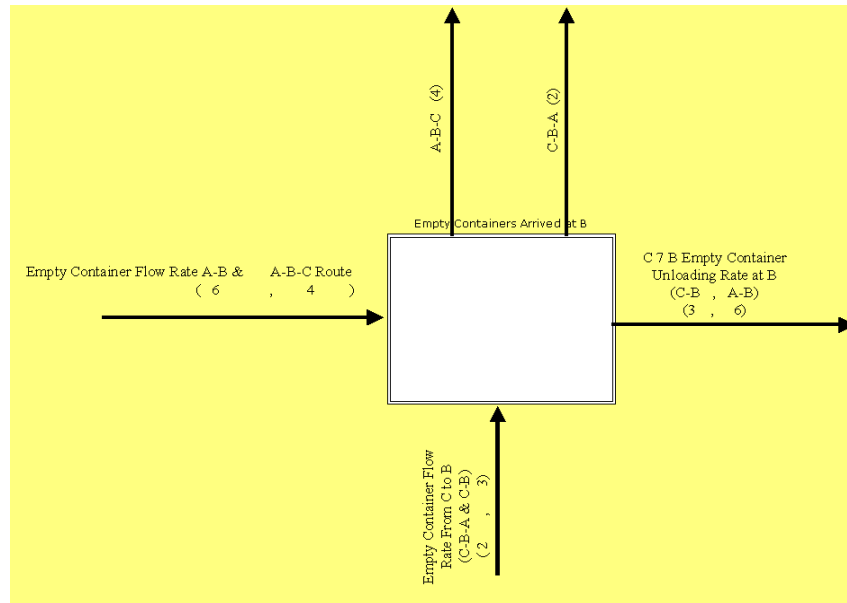
A daily demand for freight transportation is received, the number of the containers required for this transportation is calculated and the planning facility is done. Then the container stuffing operations begin. “Filling Rate for B-A Route”, “Filling Rate for B-C Route” and “Filling Rate for B-A-C Route” simulate the container filling operations. Harbor B receives demand for empty container shipments to the other harbors as well. During the planning facility, volume of the empty container shipments is calculated and empty containers are sent to the other harbors.

Shipping empty containers is simulated with the flows of “Empty Container Flows to B-A-C Route”, “Empty Container Flows to B-A Route” and “Empty Container Flows to B-C Route”. Moreover, empty containers arrive at harbor B. The arrivals are demonstrated with the flows of “Empty Containers Arriving From C-B” and “Empty Containers Arriving From A-B”.



**Figure – 4.36**  
**Empty Containers Shipped from A**

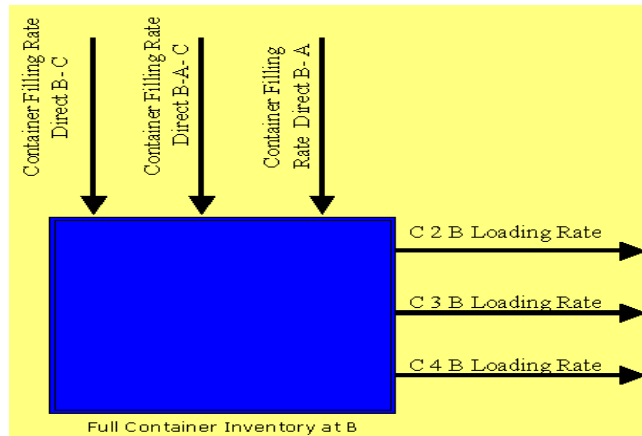
**Empty Containers Shipped From A:** The stock of “Empty Containers Shipped from A” is depicted by **Figure - 4.36**. This inventory level gives us the number of empty containers shipped from harbor A and the containers which are on the way to the destination harbors. Empty containers are loaded in harbor A according to the demand of empty containers which sent by the other harbors. The containers shipped to A-C direction take place as number “3” in the array division in the stock; containers shipped to A-B direction take place as number “6” and the empty containers being sent to A-B-C direction are numbered as “4” in the array division. The number of containers loaded and shipped to A-C direction is determined by the remaining capacity of the ship sailing from harbor B for the B-A-C direction. (See 4.6.4, **MODULE-4 Ship Capacity Effect on Full Container Loading Planning**). Empty containers of A-C combine with the flow of B-A-C. As demonstrated above, the empty containers sent to A-C combines with the flow of B-A-C and go on their journey as a single flow named as “Empty Container Rate Direct from A-C” and this flow takes place as number “3” in the array division. The other empty containers sent to A-B and A-B-C routes go on flowing with a single flow which named as “Empty Container Flow Rate A-B & A-B-C Route”.



**Figure - 4.37**  
**Empty Containers Arrived at B**

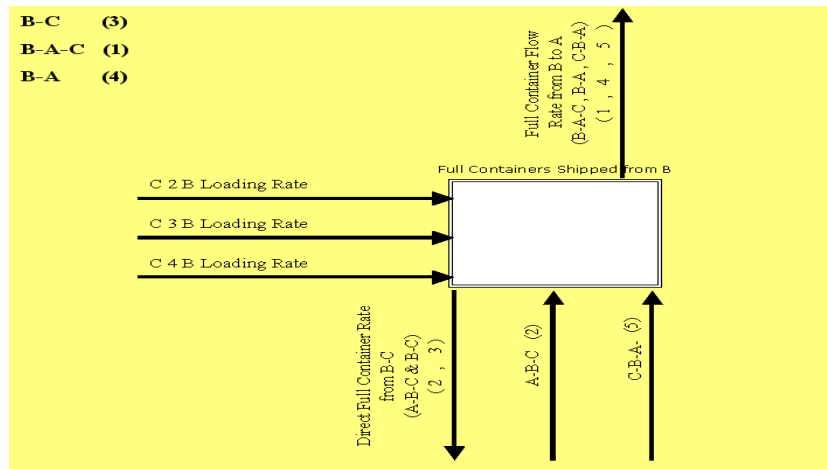
**Empty Containers Arrived at B:** As demonstrated on **Figure - 4.37**, the containers shipped from harbor B are arriving as a single flow named as “Empty Container Flow Rate A-B & A-B-C”. The containers on the route of A-B-C take place as number “4” on the array division in the stock. (See **Figure - 4.28**). The containers on the route of A-B-C arrive at harbor B, but harbor B is not the destination harbor of the empty container flow of A-B-C. Therefore, without being directed to the unloading operations the flow is going on flowing by picking up the empty containers shipped from harbor B for B-C route. Moreover, the empty containers shipped from harbor C are arriving as the flow named as “Empty Container Flow from C to B”.

Empty Container Flow Rate From C to B is consisted of two main flows: route C-B-A and C-B. C-B-A is going on flowing to harbor C without any unloading operations (Harbor B is not the destination harbor of the empty container flow of C-B-A), and flow C-B arrives at its destination harbor. **Figure - 4.37** shows that the flows arriving at the destination harbor are directed to the unloading operations. The containers shipped from the route of A-B and C-B (Harbor B is the destination harbor of empty container flows of A-B and C-B) are unloaded. Empty Container unloading operations are demonstrated as “C 7 B Empty Container Unloading Rate at B”.



**Figure - 4.38**  
**Full Container Inventory in Harbor B**

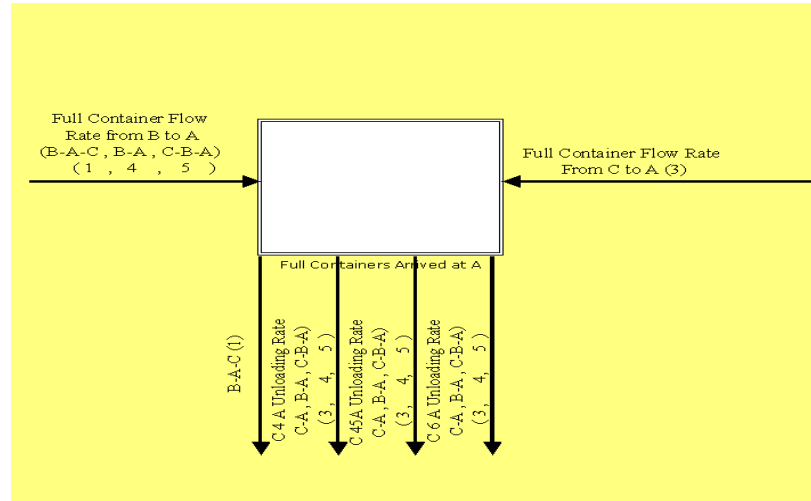
**Full Container Inventory at B:** The filling rate is planned, the container stuffing operations begin. From harbor B, containers are being sent to three different routes: B-C, B-A-C and B-A directions. The stuffed containers are loaded to the ships. The loading operations are fulfilled by the loading cranes of Crane-4 Loading Crane, Crane-3 and Crane-2. The loading operations are showed on **Figure - 4.38** as “C 4 B Loading Rate”, “C 3 B Loading Rate” and “C 2 B Loading Rate”. The inventory level of this stock gives us the number of the containers waiting for the loading operations on the terminal.



**Figure - 4.39**  
**Full Containers Shipped from Harbor B**

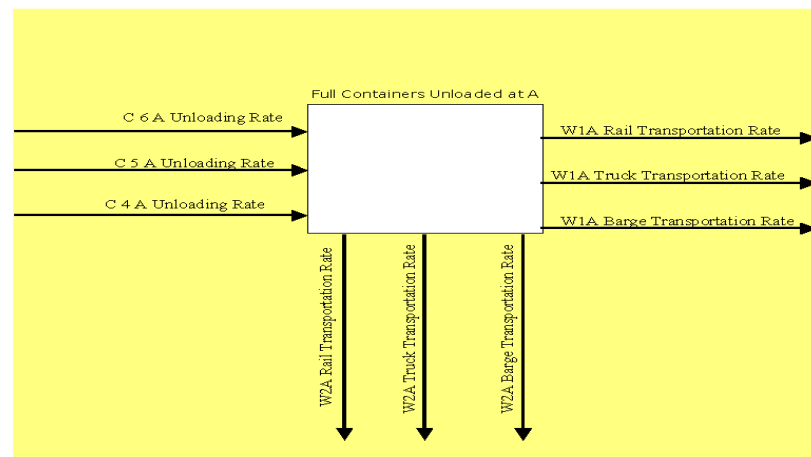
**Full Containers Shipped from B:** Being stuffed, the full containers are loaded by the loading cranes at B. The loading operations are showed as “C2B Loading”, “C3B Loading” and “C4B Loading” on **Figure – 4.39**. Each loading crane loads all the stuffed containers to the ships sailing to three main directions of B-C, B-A-C and B-A. B-C route is the continuation of the route A-B-C (Takes place as number “2” in the array division of the stock); therefore B-C (Takes

place as number “3” in the array division of the stock) coheres with the flow of A-B-C, and then goes on its route as a single flow named as “Direct Full Container Rate from B-C”. This flow includes both the flows of B-C (3) and A-B-C (2). (The array division numbers of the flows are showed with parenthesis)



**Figure – 4.40**  
**Full Containers Arrived at Harbor A**

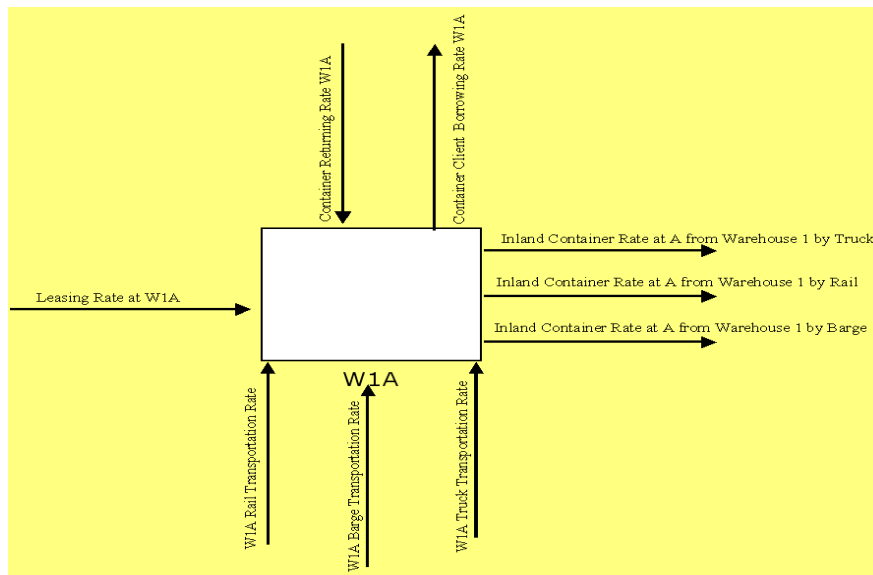
**Full Containers Arrived at A:** “Full Container Flow Rate from B to A” arrives at harbor A; but harbor A is not the destination harbor of the flow of B-A-C. Therefore, flow B-A-C is going on its route as an outflow of B-A-C (1) which is showed on **Figure - 4.40**. Arriving at their destination harbor, the containers arriving with the flow of B-A and C-B-A are unloaded. Moreover, the full containers flowing from the route of C-A reach at their destination harbor; thus these containers are directed to the unloading operations as well. The unloading operations are simulated by “C4A Unloading Rate”, “C5A Unloading Rate” and “C6A Unloading Rate”.



**Figure – 4.41**  
**Full Containers Unloaded at Harbor A**



**Full Containers Unloaded at A:** The unloading operations fulfilled by the three unloading cranes of C4A Unloading Crane, C5A and C6A unloading cranes that showed above on **Figure – 4.41**. The containers unloaded in harbor A are transported by three different transportation modes from the harbor to the warehouses of W1A and W2A. The transportation time by truck from the harbor to the warehouses is 3 days, the transportation time by rail is 6 days and by barge the transportation time is 10 days. Each transportation mode has a capacity, and the containers flow according to these capacity constrictions. (See **Figure – 4.12**). The transportations from harbor A to warehouse-1A, are simulated with the flows of “W1A Rail Transportation Rate”, “W1A Truck Transportation Rate” and “W1A Barge Transportation Rate” on **Figure – 4.41**. The containers transported from harbor A to the warehouse-2A are demonstrated as “W2A Rail Transportation Rate”, “W2A Truck Transportation Rate” and “W2A Barge Transportation Rate”.

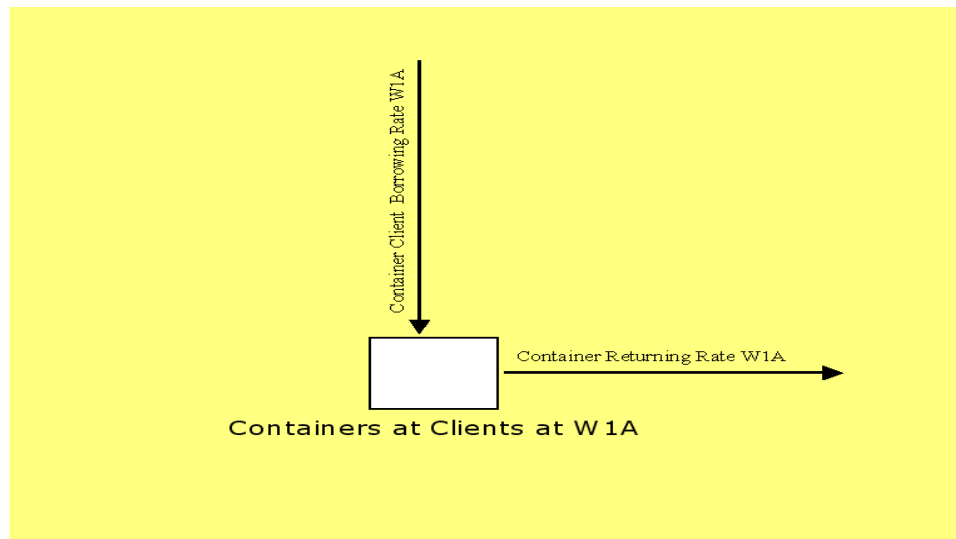


**Figure - 4.42**  
**Empty Container Inventory of Warehouse 1 at A**

**W1A:** The initial empty container inventory level of Warehouse-1A is 7,125 containers. Containers are arriving at harbor A by three different transportation modes and containers are leaving from the warehouse1A to harbor A by three different transportation modes. The desired level of W1A is 7,125 containers. There is a gap between the desired and current empty container inventory level, new containers are leased or interchanged. This facility is simulated with “Leasing Rate at W1A” on **Figure – 4.42**.

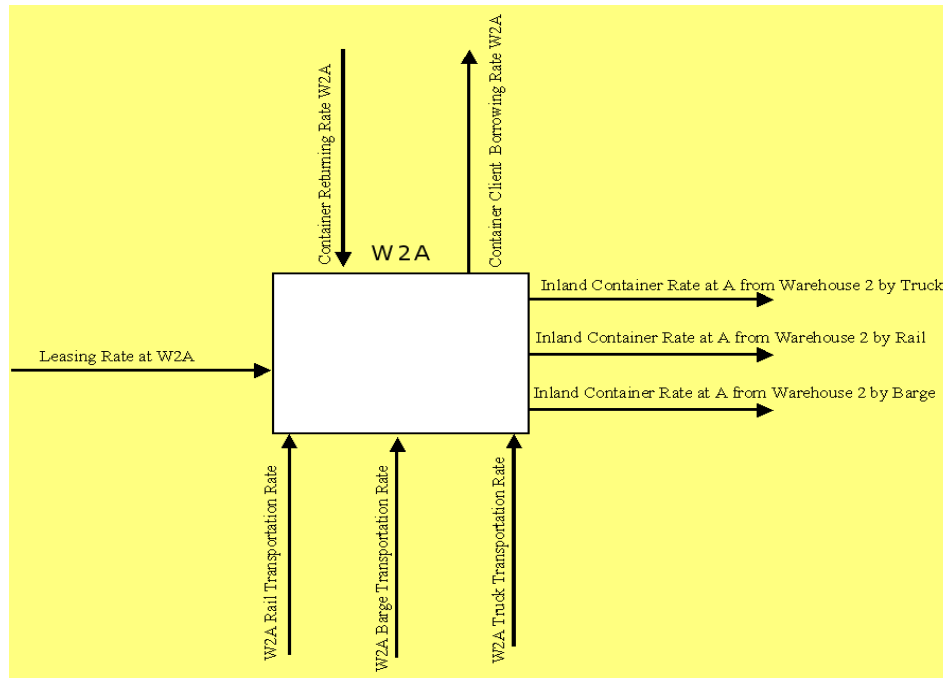
Harbor A sends demand for empty container transportation from the warehouses to the harbor. The volume of the demand is determined by the discrepancy between the desired and current level of the empty container inventory in harbor A. Therefore; containers are transported from W1A to the harbor A by truck, by rail and by barge. This facility is simulated with the variables of “Inland Container Rate at A From Warehouse 1 A By Barge”, “Inland Container Rate at A From Warehouse 1 A By Rail “, and “Inland Container Rate at A From Warehouse 1 A By Truck”. Transportation time by barge from warehouse-1 A to harbor A is 10 days, transportation time by truck is 3 days and transportation time by rail is 6 days.

It is assumed that the container company has 50 major clients to whom 10 containers delivered everyday constantly on land B. The container delivery facility is simulated with “Container Client Borrowing Rate at W1A”. The client can keep the container for 4 days. Four days later after the delivery, the containers are returned back to the company. Therefore, there is a flow of the containers returning from the clients. This facility is showed as “Container Returning Rate at W1A”.



**Figure – 4.43**  
*Containers at Clients at Warehouse 1 at A*

**Containers at Clients at W1A:** W1A is the container inventory showing the volume of the containers delivered to the clients and being kept by the clients currently. The outflow of the inventory is the containers returning back to the company 4 days later after the delivery. The inflow of “Container Client Borrowing Rate W1A” simulates the containers delivered to the clients.



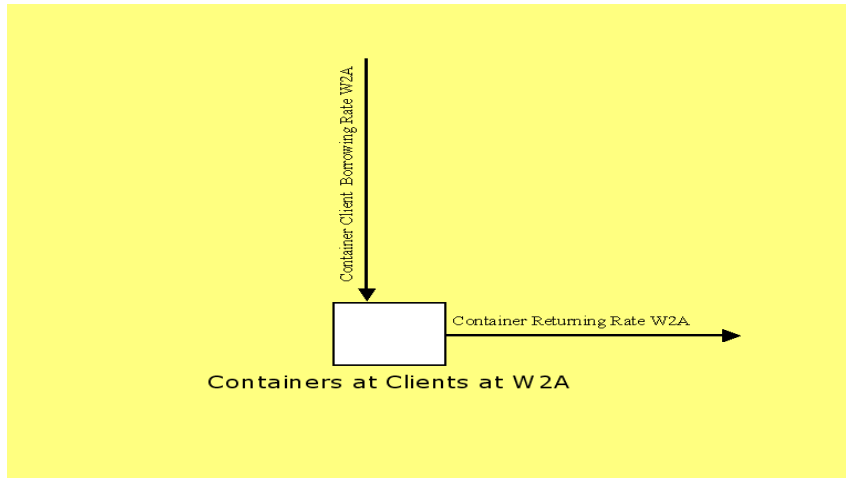
**Figure - 4.44**  
**Empty Container Inventory of Warehouse 2 at A**

**W2A:** Warehouse-2 A is one of the main container supply inventories of harbor A. The other major container supply inventory is warehouse-1A. The initial inventory level of W2A is 7,125 containers. Containers are arriving at harbor A by three different transportation modes and containers are leaving from the warehouse 2 A to harbor A in three different transportation modes. The desired level of W2A is 7,125 containers. There is a gap between the desired and current empty container inventory level, new containers are leased or interchanged. This facility is simulated with “Leasing Rate at W2A” on **Figure – 4.44**.

Harbor A sends demand for empty container transportation from the warehouses to the harbor. The volume of the demand is determined by the discrepancy between the desired and current level of the empty container inventory in harbor A. Therefore; containers are transported from W1A to the harbor A by truck, by rail and by barge. This facility is simulated with the variables of “Inland Container Rate at A From Warehouse 2 A By Barge”, “Inland Container Rate at A From Warehouse 2 A By Rail”, and “Inland Container Rate at A From Warehouse 2 A By Truck”. Transportation time by barge from warehouse-1 A to harbor A is 10 days, transportation time by truck is 3 days and transportation time by rail is 6 days.

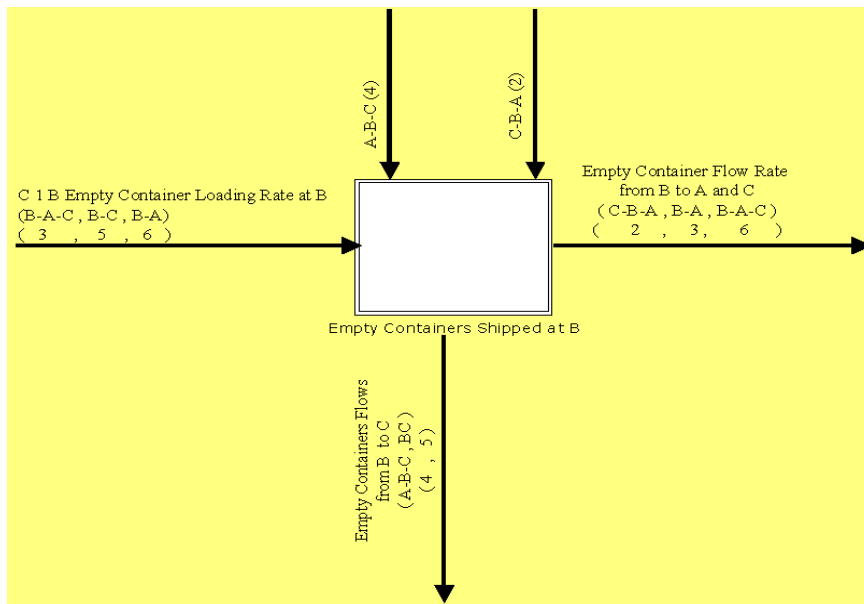
It is assumed that the container company has 50 major clients to whom 10 containers delivered everyday constantly. The container delivery facility is simulated with “Container Client

Borrowing Rate at W2A”. The client can keep the container for 4 days. Four days later after the delivery, the containers are returned back to the company. Therefore, there is a flow of the containers returning from the clients. This facility is showed as “Container Returning Rate at W2A”.



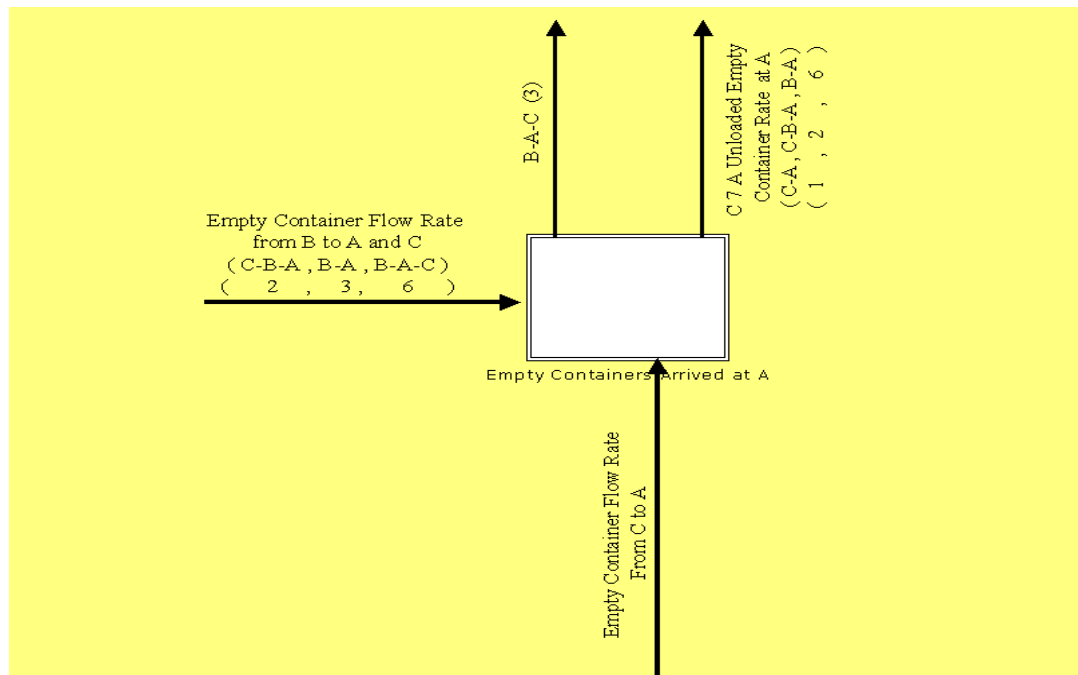
**Figure - 4.45**  
**Containers at Clients at Warehouse 2A**

**Containers at Clients at W2A:** W2A is the inventory indicating the number of the containers the clients are holding. The inventory has one inflow and one outflow. The inflow is the containers delivered to the clients and the outflow of this stock is the containers sent back to the container company 4 days later after the delivery.



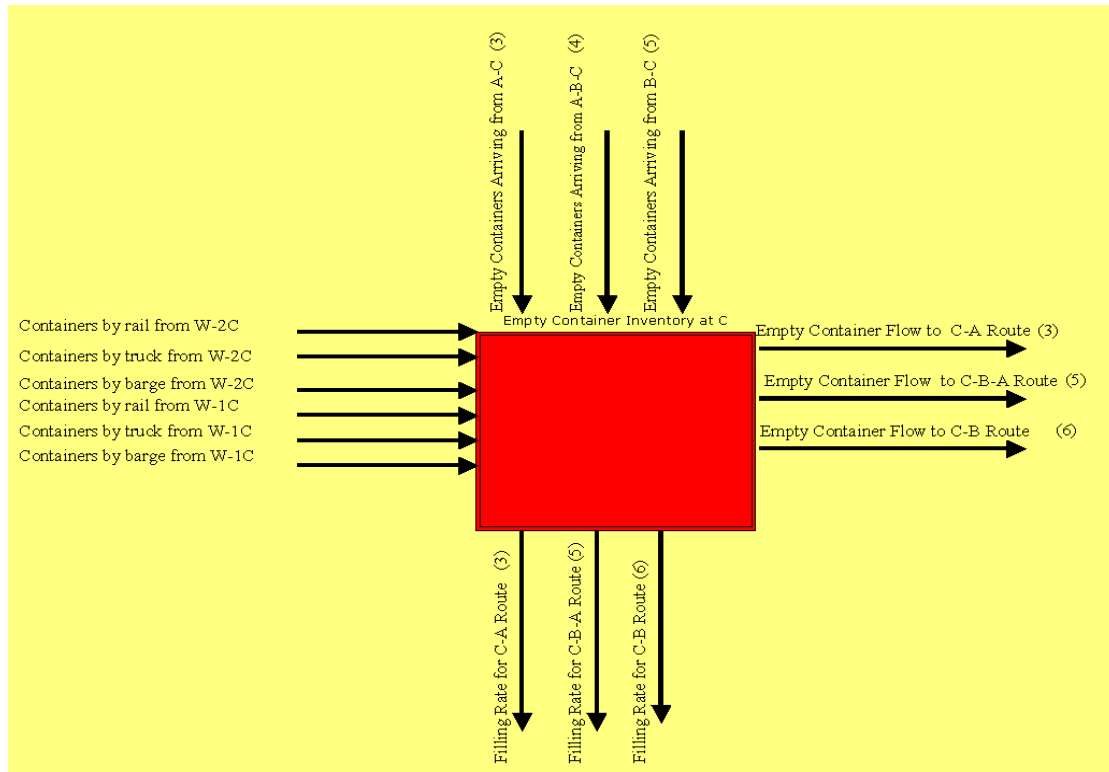
**Figure - 4.46**  
**Empty Containers Shipped at B**

**Empty Containers Shipped at B:** As depicted on *Figure - 4.46* this stock shows the empty containers on the way to their destination harbor. The empty containers are loaded, they are sent to their destination harbor. Route B-C is the continuation of route A-B-C. Therefore route B-C and A-B-C cohere and go on flowing as a single flow named as “Empty Container Flows from B to C”. Moreover, the flow of C-B-A coheres with the flow B-A; because route B-A is the continuation of route C-B-A. The containers on the routes of C-B-A , B-A and B-A-C flow together as a single flow named as “Empty Container Flow Rate from B to A and C”.



**Figure - 4.47**  
**Empty Containers Arrived at A**

**Empty Containers Arrived at A:** As depicted on *Figure - 4.47*, the containers flowing on the routes of C-A, B-A-C and B-A are arriving at the destination harbor. The containers arriving at the destination harbor are unloaded by the C7A unloading crane. Unloading operations are simulated with “C7A Unloading Empty Container Rate at A”. The containers on B-A-C route are going on flowing, because harbor A is not the destination harbor of B-A-C flow. The containers going on flowing without being directed to the unloading operations are demonstrated as B-A-C on *Figure - 4.47*.

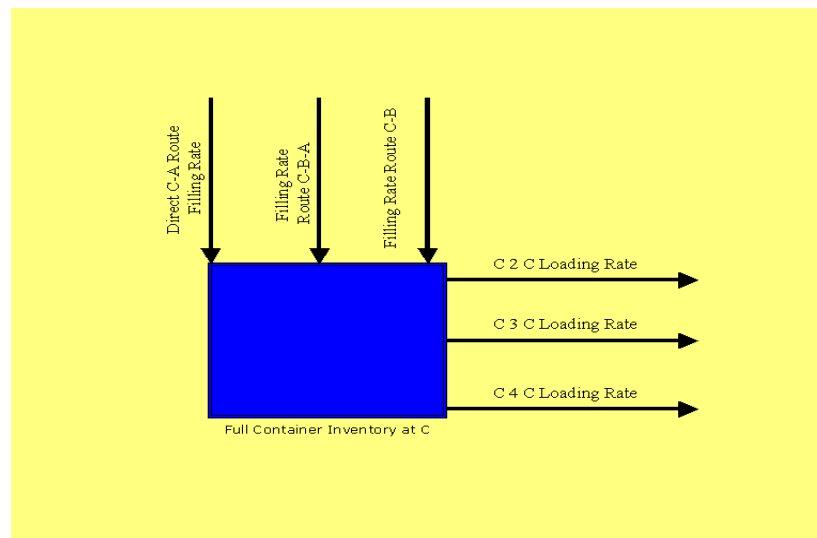


**Figure - 4.48**  
**Empty Container Inventory in Harbor C**

**Empty Container Inventory at C:** Figure 4-48 shows the empty container inventory in harbor C. There are three main directions that the containers are shipped from harbor C: C-A, C-B-A and C-B route. The initial level of the empty container inventory in harbor C is 59,375 containers. The desired inventory level is 60,000 containers. Empty containers are shipped from harbor C according to volume of the empty container transportation demand sent by the other harbors. It was explained that the volume of the empty container shipments is determined by the other harbors sending the empty container shipment demand. The volume of the empty container shipment is determined by the discrepancy between the desired and the current empty container level of the harbor sending the empty container shipping demand. The harbor calculates that the volume of the containers transported from the inland is not enough to close the gap between the desired and the current empty container level in the harbor, it sends empty container transportation demand to the other harbors. The empty container shipments arriving are showed as “Empty Container Flow to C-A”, “Empty Container Flow to C-B-A” and “Empty Container Flow to C-B”. Besides, harbor C sends demand to the warehouses for empty container transportation from the warehouses to the harbor. The volume of the demand is determined by the

discrepancy between the desired and current level of the empty container inventory in harbor C. Therefore; containers are transported from W1C and W2C to the harbor C by truck, by rail and by barge. The empty container transportation from the inland is simulated with “Containers by Truck from W2C”, “Containers by Barge from W2C”, “Containers by Rail from W2C”, “Containers by Truck from W1C”, “Containers by Barge from W1C”, “Containers by Rail from W1C”.

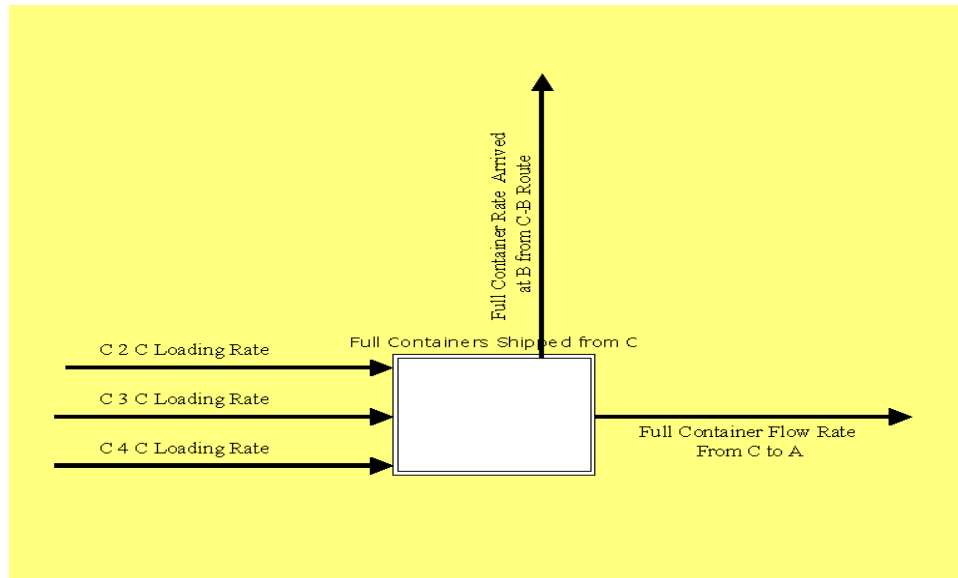
Harbor C receives demand for freight transportation as well. The planning facility is done and the number of the containers required for this transportation is calculated and the containers are stuffed and filled. The stuffing operations are demonstrated with “Filling Rate C-A Route”, “Filling Rate C-B-A Route” and “Filling Rate C-B Route” on **Figure - 4.48**.



**Figure - 4.49**  
**Full Container Inventory in Harbor C**

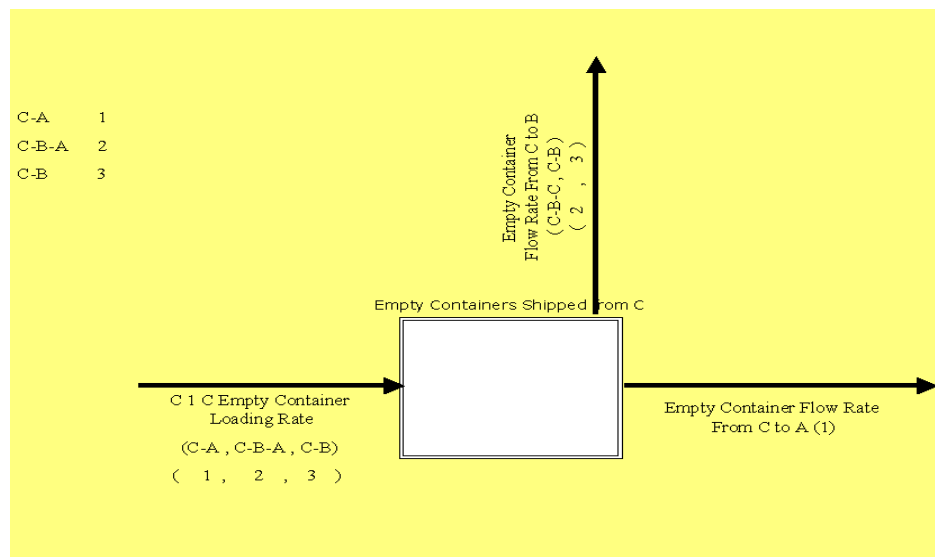
**Full Container Inventory at C:** **Figure - 4.49** depicts the full container inventory in harbor C. This stock shows the number of containers having been stuffed and waiting to be loaded to the ships. The stuffing operations are done according to the transportation directions. The stuffing operations are simulated with the inflows of “Direct C-A Route Filling Rate”, “Filling Rate Route C-B-A”, “and Filling Rate Route C-B”.

The stuffed containers are loaded to the ships by the loading cranes of C2C, C3C and C4C Loading Cranes.



**Figure - 4.50**  
**Full Containers Shipped from Harbor C**

**Full Containers Shipped from C:** Figure - 4.50 depicts the full containers shipped from harbor C. This stock shows the loaded containers on the way to their destination harbor. The stuffed containers being sent to the routes of C-A, C-B-A and C-B are loaded by the loading cranes of C2C, C3C and C4C Loading cranes. The containers shipped for the direction of C-A simulated with the flow of “Full Container Flow Rate from C to A”. The containers shipped for C-B-A route cohere with the containers on C-B route and flow together between harbor C and harbor B.

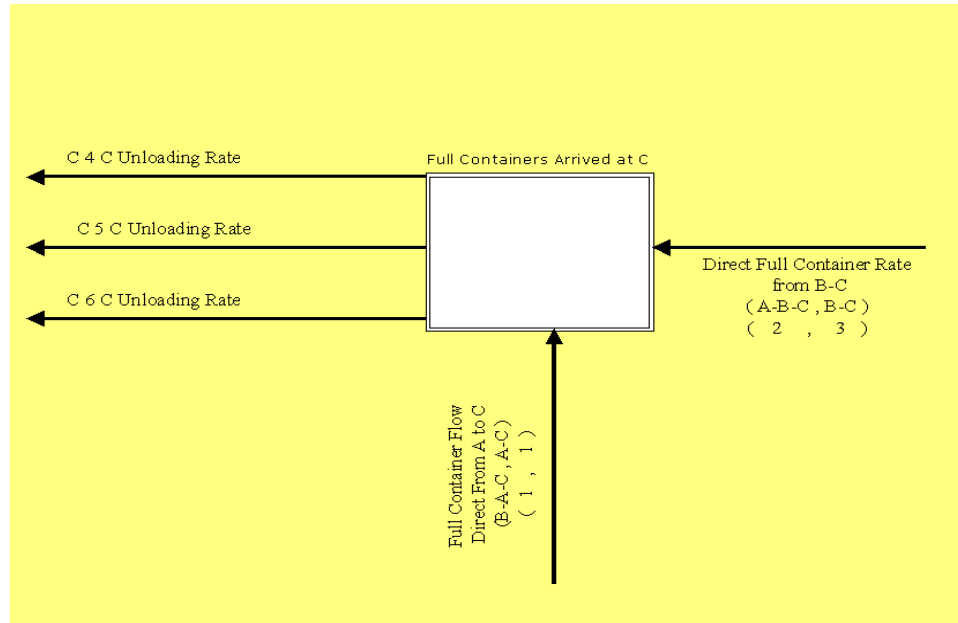


**Figure - 4.51**  
**Empty Containers Shipped from C**



**Empty Containers Shipped from C:** The empty containers loaded are shipped to two main directions. Empty containers shipped to C-B-A and C-B directions are simulated with the flow of “Empty Container Flow Rate from C to B”. This flow includes two flows: C-B-A and C-B. The flow of C-B-A takes number “2” in the array division, and C-B takes number place as number “3” in the array division.

The containers sent to the C-A direction is simulated with the flow of “Empty Container Flow Rate from C to A”.

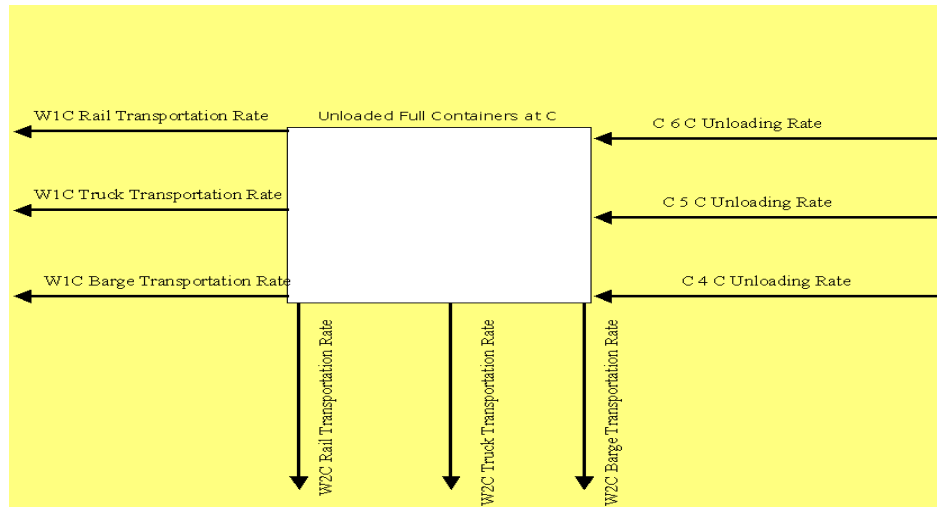


**Figure - 4.52**  
**Full Containers Arrived at Harbor C**

**Full Containers Arrived at C:** Full containers shipped from the origin harbor and arriving at their destination harbor are unloaded by the unloading cranes of C4C Unloading, C5C and C6C. The unloading operations are simulated with “C4C Unloading Rate”, “C5C Unloading Rate” and “C6C Unloading Rate” on **Figure - 4.52**

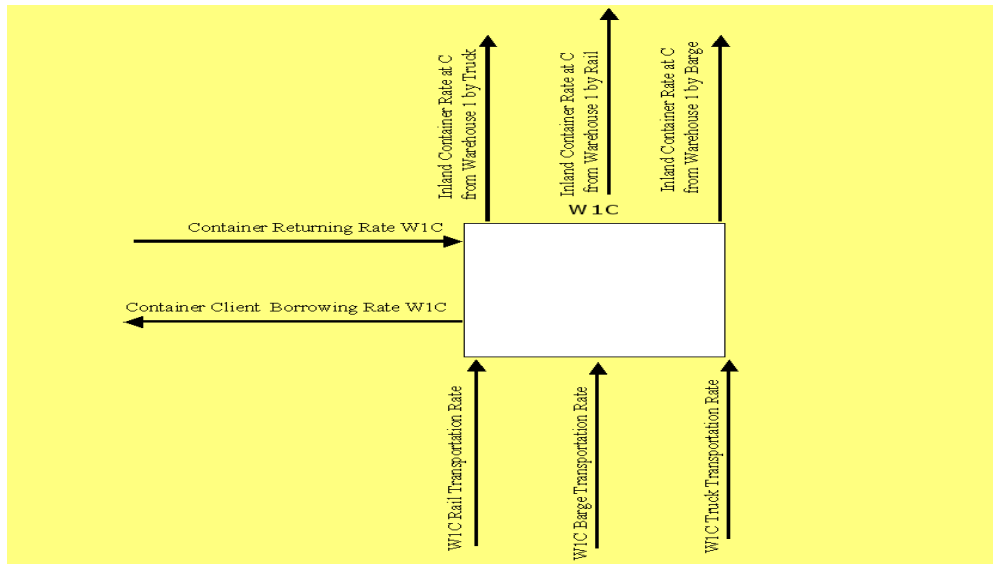
The containers shipped for A-B-C route combine with the containers shipped for B-C route. Therefore, the flow of “Direct Full Container Rate from B-C “is consisted of two flows.

The containers shipped for B-A-C route combine with the containers shipped for A-C route. Although the flow of “Full Container Flow Direct from A to C” is consisted of two flows this combination takes as number “1” in the array division in the flow.



**Figure - 4.53**  
**Unloaded Full Containers in Harbor C**

**Unloaded Full Containers at C:** The unloaded full containers are sent to the inland warehouses of W1C and W2C. There are three transportation modes in sending the full containers from harbor C to the inland. Each transportation mode's capacity limits and transportation time are showed on **Figure – 4.10**. Each outflow on **Figure - 4.53** simulates the containers transported by each transportation mode between harbor C and the warehouses.



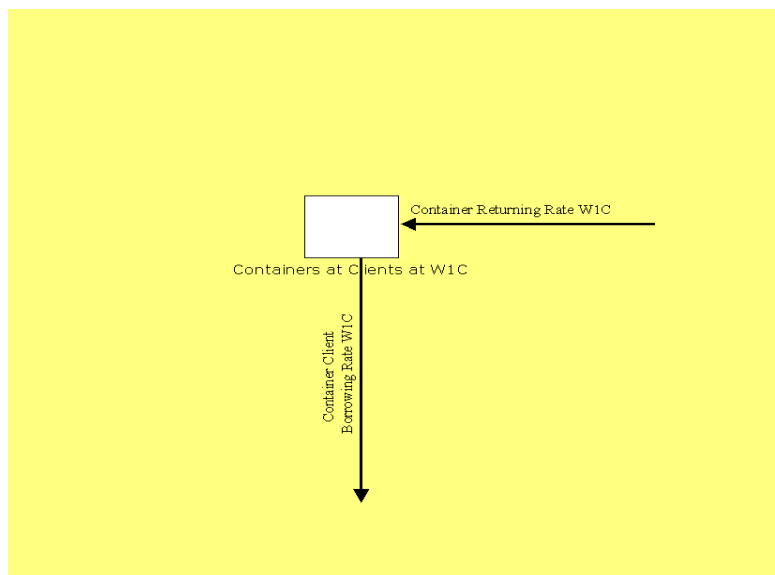
**Figure - 4.54**  
**Empty Container Inventory of Warehouse 1 at C**

**W1C:** **Figure – 4.54.** shows the empty container inventory of warehouse 1 at C. The initial empty container inventory level of Warehouse-1C is 7,000 containers. Containers are arriving at

harbor C by three different transportation modes and containers are leaving from the warehouse1C to harbor C by three different transportation modes.

Harbor C sends demand for empty container transportation from the warehouses to the harbor. The volume of this demand is determined by the discrepancy between the desired and current level of the empty container inventory in harbor C. Therefore; containers are transported from W1C to the harbor C by truck, by rail and by barge. This facility is simulated with the variables of “Inland Container Rate at C From Warehouse 1 C By Barge”, “Inland Container Rate at C From Warehouse 1 C By Rail “, and “Inland Container Rate at C From Warehouse 1 C By Truck”. Transportation time by barge from Warehouse-1 C to harbor C is 10 days, transportation time by truck is 3 days and transportation time by rail is 6 days.

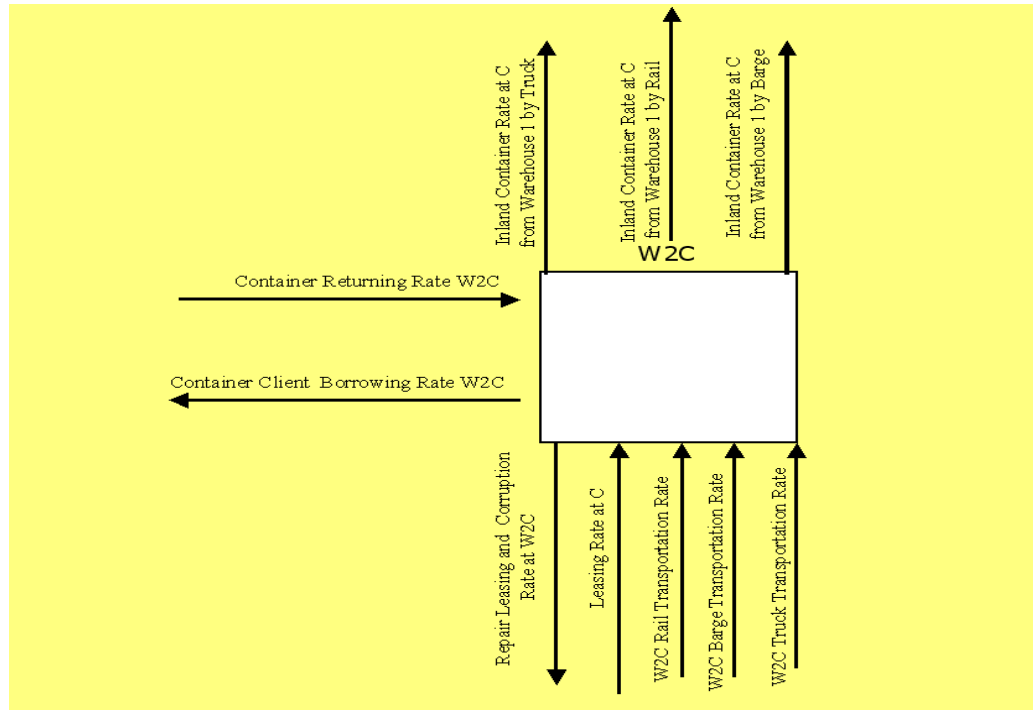
It is assumed that the container company has 50 major clients to whom 10 containers delivered everyday constantly. The container delivery facility is simulated with “Container Client Borrowing Rate at W1C”. The client can keep the container for 4 days. Four days later after the delivery, the containers are returned back to the company. Therefore, there is a flow of the containers returning from the clients. This facility is simulated with “Container Returning Rate at W1C”.



**Figure - 4.55**  
**Containers at Clients at W1C**

**Containers at Clients at W1C:** This stock depicts the number of the containers being kept by the clients. The inflow of this stock is the containers delivered to the clients and the outflow of the

stock depicts the containers returning back to the company 4 days later after the delivery. As explained previously, the time that a container can be kept by a client is maximum 4 days.



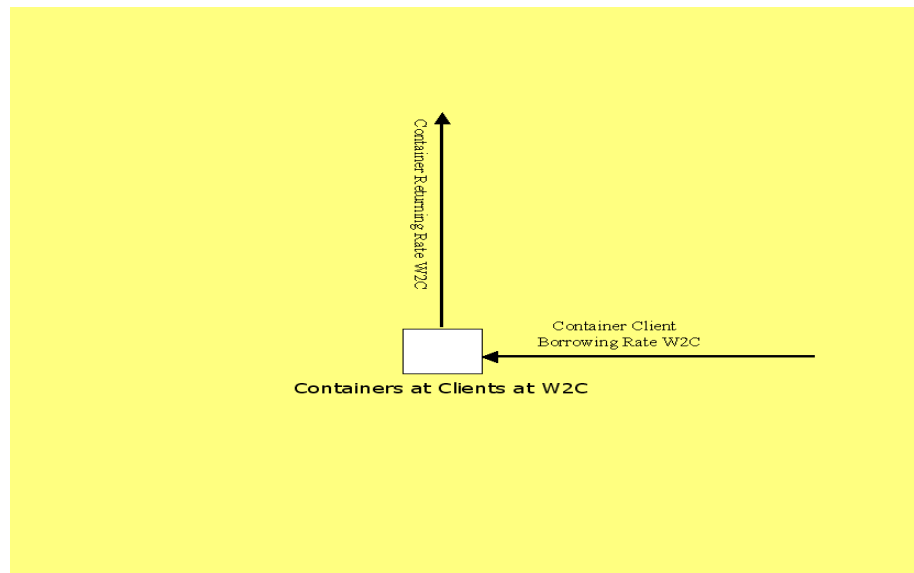
**Figure - 4.56**  
**Empty Container Inventory of Warehouse 2 at C**

**W2C:** Compared to the other warehouses, Warehouse-2C at C has a different characteristics. The containers filling their life span must leave the system and must be disposed. It is assumed that the container life time is 10 years. Everyday 77 containers are disposed according to the life time of a container.

The containers need to be repaired are sent to repair. It is assumed that 0,0002665 per cent of the whole container inventory that the company has are sent to be repaired everyday; i.e. everyday 75 containers are sent to be repaired, and in total, everyday 153 containers are leaving the container inventory of the company due to the disposal or repair. The repair and disposal facility is simulated with the flow of “Repair, Leasing and Corroption Rate at W2C”. Moreover, the initial inventory level of W2C is 6,848 containers, and the desired inventory level is 7,000 containers. There is a gap between the desired and current empty container inventory level, containers are leased or interchanged; therefore, a leasing and interchanging site is built here. The daily capacity of leasing or interchanging is 250 containers per day.

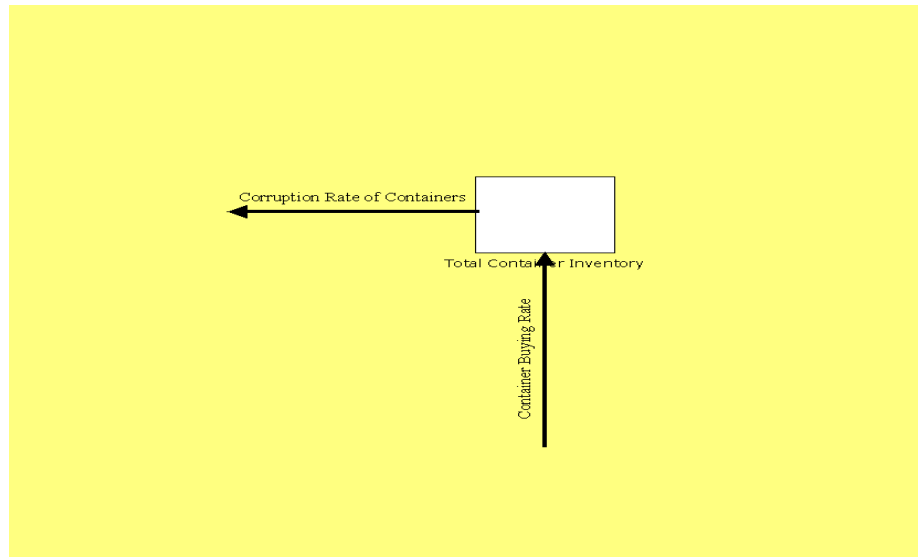
Harbor C sends demand for empty container transportation from the warehouses to the harbor. The volume of the demand is determined by the discrepancy between the desired and current level of the empty container inventory in harbor C. Therefore; containers are transported from W2C to the harbor C by truck, by rail and by barge. This facility is simulated with the variables of “Inland Container Rate at C From Warehouse 2 C By Barge”, “Inland Container Rate at C From Warehouse 2 C By Rail “, and “Inland Container Rate at C From Warehouse 2 C By Truck”. Transportation time by barge from warehouse-2 C to harbor C is 10 days, transportation time by truck is 3 days and transportation time by rail is 6 days.

It is assumed that the container company has 50 major clients to whom 10 containers delivered everyday constantly. The container delivery facility is simulated with “Container Client Borrowing Rate at W2C”. The client can keep the container for 4 days. Four days later after the delivery, the containers are returned back to the company. Therefore, there is a flow of the containers returning from the clients. This facility is simulated with “Container Returning Rate at W2C”.



**Figure - 4.57**  
**Containers at Clients at W2C**

**Containers at Clients at W2C:** This inventory depicts the containers being kept by the clients. There are two main flows: the containers delivered to the clients are demonstrated as an inflow and the containers returning back to the company 4 days later after the delivery are demonstrated as an outflow on **Figure - 4.57**.



**Figure - 4.58**  
**Total Container Inventory**

**Total Container Inventory:** *Figure - 4.58* depicts the total number of the container inventory of the company. This inventory is created according to the total number of the containers the company has in the inventories on land A, B and C. It is assumed that a container life time is 10 years; therefore 77 containers are being disposed daily. New containers are bought to keep the container inventory at the desired level. The initial level of “Total Container Inventory” of the company is 281,605 containers. The desired level of the inventory is 281,605 containers. 77 new containers are bought daily. The buying facility is showed as “Container Buying Rate” and the disposal facility is showed as “Corruption Rate of Containers”

There are three more stocks created for the simulation model:

- ❑ Interchanging Site at A
- ❑ Leasing Company at B
- ❑ Interchange & Leasing Site at C

These stocks are exogenous and we don’t have control over them; these stocks are used just to supply our stocks that we can manage.

## **4.6 Modules**

Until now, the dynamic container flow structure is created; i.e. the network the containers flowing in is built. In this part the conditions confining the empty and full container flows are created. The modules of harbor A is exemplified and explained. Mainly, 12 main modules are built for each harbor:

- **MODULE-1** Calculating Number of the Containers Required for the Demand for Freight Transportation.
- **MODULE-2** Empty Container Loading Pre-Planning at Harbor A
- **MODULE-3** Full Container Loading Pre-Planning at Harbor A
- **MODULE-4** Ship Capacity Effect on Full Container Loading Planning
- **MODULE-5** Full Container Unloading Planning
- **MODULE-6** Empty Container Unloading Planning at A
- **MODULE-7** Filling Rate Planning at Harbor A According to the Ship Capacity-Equipment Capacity and Work Capacity (Resource Planning at A)
- **MODULE-8** Harbor Productivity Module
- **MODULE-9** Idle Container Ratio
- **MODULE-10** Empty Container Ratio
- **MODULE-11** Network Module at Harbor A (Number of Ships Arriving & Departing)
- **MODULE-12** Inventory Level Effect on Transportation Selection Mode at Harbor A

### **4.6.1 MODULE-1 Converting the Demand for Transportation into Number of Containers**

The demand for freight transportation is classified according to the locations or shipping directions of the deliveries. There are 3 shipment directions originating from harbor A: A-C, A-B and A-B-C; therefore 3 sorts of demand for freight transportation are received at harbor A. The total demand for the freight transportation is the cumulated value including the demand for transportation to three shipment directions from harbor A. The demand for freight transportation is received as tonnage, a planning facility begins to calculate the number of the containers required for the transportation. In **MODULE-1** the demand for transportation received in

tonnage is converted into the number of containers according to the container maximum carrying and dimensional capacity.

It is assumed that, the company is shipping all the freight with 40` containers. The maximum tonnage that a 40` container can carry is 30,480 kg and maximum 58 m<sup>3</sup> equal staff can be loaded into a 40` container. (*See Chapter-2, 2.3.1 Container Classifications and Capacity Qualifications*)

The demand in tonnage is converted into the number of containers according to the maximum carrying capacity of a container and this calculation is simulated with the variable of “Number of Containers According to Tonnage from A for ... Route”. The demand for transportation is converted into m<sup>3</sup> unit according to the stowage factor. Stowage factor of any commodity is the number of cubic feet (cubic meters) which a ton of that commodity will occupy in stowage. Converting the demand for freight transportation into m<sup>3</sup> unit is simulated with the variable of “Total Demand in m<sup>3</sup> for .... Route”. The value in m<sup>3</sup> unit is converted into the number of containers according to the maximum dimensional capacity of a 40` container and this calculation represented by the variable of “Number of Containers According to m<sup>3</sup> to ... Route”.

Firstly, the total demand for freight transportation is converted into m<sup>3</sup> and tonnage. Secondly, these two values converted into the number of containers according to the container carrying and dimensional capacity. Consequently two different values are calculated. These two values are represented by two variables of “Number of Containers According to Tonnage from A for ... Route”, “Number of Containers According to m<sup>3</sup> to ... Route”.

It would be useful to exemplify what these two variables are indicating: “If you are planning to send this amount of freight according to the dimensional capacity of a container, 100 containers are required and for the same transportation 80 containers are required according to the weight carrying capacity of a container.” The final decision for the number of containers required for the transportation is the maximum of these two values. While the transportation requires 80 containers according to the carrying capacity of a container, if the same transportation requires 100 containers according to the container dimensional capacity, it means that the freight is not heavy but it requires more space. The calculation of choosing the maximum value is done with the variable of “Indicated Number of Containers to ...”. The number of the containers required for the transportation is determined, each container’s weight is calculated. Tracking each



container's weight is conducive in tracking the total weight loaded/unloaded by each crane while calculating the productivity of the harbor.

#### **4.6.2 MODULE-2 Empty Container Loading Pre-Planning at Harbor A**

The harbors are sending empty container transportation demand to each other according to the discrepancy between the desired and the current level of empty container inventory in the harbor. As mentioned previously, there are three main empty container inventories in three harbors of A, B and C. Each container inventory has 59,375 containers initially. The desired level of each empty container inventory is 60,000 containers for harbor A, B and C. In the model, additional variables of "Effective Empty Container Inventory at A", "Effective Empty Container Inventory at B" and "Effective Empty Container Inventory at C" are created. Effective empty container inventory is the inventory which the containers being expected to arrive in the next three day period included to. All the containers being expected to arrive from inland inventories and from the other harbors are included to this amount.

It is assumed that if a container flow arrives at the harbor, the next three days the same volume of container flow from the same directions is expected to arrive; thus the expected amount of container arrival is the three times multiplied amount of the daily arrivals. These calculations are represented with the variables of "Effective Empty Container Inventory at A (Included 3 days Containers on the Way)", "Effective Empty Container Inventory at B (Included 3 days Containers on the Way)" and "Effective Empty Container Inventory at C (Included 3 days Containers on the Way)".

In **MODULE-2**, the volume of the demand for empty container shipments from the other harbors is calculated according to the gap between the desired level of empty container inventories and the effective empty container levels (The volume of the containers arriving in 3 days is included). For instance, "Empty Container Demand to A-C Direct Route at A" is the gap between the Effective Empty Container Inventory at C and the desired level of empty container level at C. Harbor C calculates the volume of the containers arriving in the next 3 days and adds this amount to the current level of empty container inventory, and after that harbor C calculates what is the gap between the desired level and the calculated amount. There is a gap, harbor C sends empty container demand to the other harbors. "Empty Container Demand to A-C Direct

Route at A” depicts that harbor A received this empty container demand from C and according to that demand harbor A is sending empty containers to harbor C. The same calculation method is applied to the other routes of A-C and A-B-C. “The Total Empty Container Demand at A” is the total value of the empty containers shipped for three directions.

As explained previously, Crane-1 is allocated for loading the empty containers and its loading capacity is 250 containers per day. While planning the number of the empty containers to ship, if the volume of the total empty container demand for empty container shipment is larger than the capacity of Crane-1, empty container shipments are rejected or postponed. The rejection or postponing is done according to the priority of the routes of the harbors. Each harbor has its own priority for shipping directions. (*See Chapter 4, 4.4.6 Container Transportation Routes Between the Harbors*) For instance, the 1<sup>st</sup> priority in harbor A is route A-C, the 2<sup>nd</sup> priority is route A-B and the last priority is route A-B-C. It means that, if there is a gap in empty container loading capacity, some empty container shipments are rejected. Firstly, the demand for the route A-C is shipped. Secondly, the empty container shipment demand for route A-B is fulfilled according to the remaining empty loading capacity of Crane-1 and lastly the empty container shipment demand for the route A-B-C fulfilled if Crane-1 has empty container loading capacity.

Crane-1’s empty container loading capacity is 250 containers per day. For instance, the demand for empty container shipment for A-C direction is 150 containers and for A-B direction the demand for empty container shipment is 120 containers, the empty container shipment for A-C direction is fulfilled firstly; because shipment direction of A-C has the 1<sup>st</sup> priority. The empty container shipment for A-C direction is fulfilled, the remaining empty container loading capacity of Crane –1 is 100 containers. (Crane-1 Empty Container Loading Capacity – Volume of the Shipment to A-C Direction). Although the demand of empty container shipment for A-B route is 120 containers, 100 empty containers of 120 empty container shipment demand can be fulfilled due to the remaining loading capacity of Crane-1. This can be regarded as a reduction or a selection in the demand the company received for empty container shipments. The volume of the empty container shipments after the elimination is represented by the variables of “Effective .... Route Empty Container Demand”. Each Effective value of the demand for empty container shipment is sorted according to its shipping direction. “The Effective Demand” can be regarded as the volume of the empty container shipments accepted by the company for each shipping direction. Each accepted volume of empty container shipment is converted into a ratio according

to Crane-1 empty container loading capacity and Crane-1 empty container loading capacity is allocated among the three routes.

The excessive empty container loading capacity is calculated according to the total effective demand (Effective Demand for A-C+ Effective Demand for A-B+ Effective Demand for A-B-C) and this excessive capacity is allocated among the other full container loading cranes in the case of a full container loading capacity gap.

#### ***4.6.3 MODULE-3 Full Container Loading Pre-Planning at Harbor A***

One of the functions created in the simulation model is calculating the harbor's productivity. The productivity of a harbor is mainly related to the throughput of the harbor; i.e. the total amount of the freight or the total number of the containers loaded/unloaded by the cranes. Each loading/unloading crane's productivity has a considerable impact on the total productivity of the harbor.

Crane-1 is allocated for empty container loading operations and Crane-7 is allocated for empty container unloading operations. In a case of low empty container demand for empty container shipments or low volume of empty container arrivals, excessive capacity occurs for the crane allocated for the empty equipment loading/unloading. To render the simulation model more realistic, an excessive capacity function is added and this excessive capacity can be used by the other loading/unloading cranes. The utilization means that Crane-1 or Crane-7 has an excessive capacity due to the low volume of loading/unloading empty container operations, these cranes are allocated for assisting in the full container loading/unloading operations. The utilization of excessive capacity of Crane-1 or Crane-7 alleviates the burden of each full container loading/unloading crane. While loading the empty containers, if there is low level of empty container demand for shipment, Crane-1 finishes its job earlier than usual. Therefore the crane is allocated for assisting in the other full container loading cranes of Crane-2, Crane-3 and Crane-4 loading. The same allocation and appointment method is done for Crane-7 as well.

The number of the containers loaded/unloaded for each shipping direction in each harbor is calculated for tracking the productivity of each crane. Besides, the total weight loaded/unloaded to each shipping direction by each loading/unloading crane is calculated. Therefore, a very detailed classification is done to track how many containers are shipped and arrived; how much weight is loaded and unloaded according to each shipping direction and according to each loading/unloading crane. Moreover, each utilization of excessive capacity, each capacity gap for

each direction and each capacity for each crane are classified and tracked in detail. **MODULE-3** is built to make these detailed classifications and calculations.

It is assumed that for each direction the “Init. Capacity Allocated for A-C, A-B etc... Route” is 250 containers equally. The initial capacity gap and excessive capacity is calculated according to the gap between the received demand for freight transportation for each route and the initial capacity allocated for each direction. (For instance, the demand for freight transportation for A-C is 200 container, the initial capacity allocated for A-C is 250 containers.  $250 \text{ containers} - 200 \text{ containers} = 50 \text{ container excessive capacity}$  and  $0 \text{ container initial capacity gap}$ ).

“Total Gap for Loading Capacity” is calculated by subtracting each route’s excessive capacity from each route’s initial capacity gap and cumulating each calculated value.

For instance, the demand for freight transportation for A-C is 200 containers, for A-B 250 containers and for route A-B-C 300 containers. For route A-C ( $250 - 50 = 50 \text{ container excessive capacity}$  and  $0 \text{ container initial capacity gap}$ ). For A-B Route,  $250 - 250 = 0 \text{ container excessive capacity}$  and  $0 \text{ container initial capacity gap}$ . For A-B-C,  $250 - 250 = 0 \text{ container excessive capacity}$  and  $0 \text{ container initial capacity gap}$ . Total Gap for Loading Capacity =  $\text{Max}(0, ((0+0+0) - (50+0+0))) = 0 \text{ container}$ .

Total gap for loading capacity is classified according to the shipping routes and each route’s gap is named as “Capacity Gap for Direct A-C Route”, “Capacity Gap for A-B Route”, “Capacity Gap for Direct A-B-C Route” etc...

The excessive capacity utilized by each crane is tracked and classified, too. Therefore, “Excessive Capacity C1A” is allocated among the shipping directions according to the capacity gap of each shipping route. As mentioned previously, in each harbor the shipping directions are sorted due to the priorities. In harbor A, route A-C utilizes the excessive capacity of C1A firstly due to the first priority of route A-C, and due to the gap. Secondly, route A-B utilizes the remaining excessive capacity of C1A and lastly route A-B-C having the 3<sup>rd</sup> priority utilizes the excessive capacity of C1A.

The function generated in **MODULE-1** is enabling us to track each container’s weight according to each shipping direction. After the excessive capacity is allocated among the loading cranes, this utilized amount is converted into tonnage. To illustrate, if there is 150 container excessive capacity of C1A, and if 30 containers of this capacity is allocated for route A-C, 45 containers for A-B and 75 containers for A-B-C route and if the average weight of the containers being shipped

to A-C direction is 20 ton, the average weight of the containers shipped to A-B direction is 25 ton, and if the average weight of the containers shipped to A-B-C is 30 ton, C1A loads 20 ton/container\*30container for A-C route, 25 ton/container \*45 container for A-B route and 30 ton/container \*75 container for A-B-C route by assisting in the loading cranes of C2A, C3A and C4A Loading. Variable of “Excessive Container Capacity Utilized from C1A by each loading crane” demonstrates the excessive capacity utilized from C1A by each loading crane as number of containers in <<container>> unit and the variable of “Excessive Capacity Utilized of C1A by each loading crane as tonnage” denotes the same volume as tonnage; i.e. in the unit of <<ton>>. Explaining the variable of “Filling Gap at A” would be conducive to understand **MODULE-3**. Previously it was explained that some container shipments were rejected according to the capacity constrictions. The rejection and elimination is done, the filling operations begin. “Desired Filling Rate at Harbor A” denotes the volume of the demand for container shipments before the elimination is done. (*See MODULE-7*)

There are three main factors affecting the “Filling Rate at A According to the Crane Capacity and Demand”:

- Filling Capacity from Work and Equipment at A
- Effective Filling Capacity from Empty Containers
- Effective Total Full Container Capacity at A. (*See MODULE-7*)

“Filling Rate at A According to the Crane Capacity and Demand” is the minimum value of “Filling Capacity from Work and Equipment at A”, “Effective Filling Capacity from Empty Containers” and “Effective Total Full Container Capacity at A”.

“Filling Capacity from Work and Equipment at A” is the capacity constricted by the number of filling stations, number of working days and each container filling operation time.

“Effective Filling Capacity from Empty Containers” is the capacity constricted by the level of the empty container inventory in the harbor.

“Effective total full container capacity at A” is the total loading capacity that the excessive empty container loading capacity of Crane-1 is included. (Excessive Capacity of Crane-1+ Crane-2 Loading Cap. +Crane-3 Loading Cap. +Crane-4 Loading Cap.) By cumulating the received demand for freight transportation for each route, the “Total Demand at A” is calculated. ( Demand for A-C+Demand for A-B+Demand for A-B-C). The variable of “Total Full Container

Loading Capacity at A” is calculated by cumulating each loading capacity of Crane-2, Crane-3 and Crane-4, “Total Loading Capacity Gap at A” is the gap between the “Total Demand at A” and the “Total Full Container Loading Capacity at A”. If there is a gap in total loading capacity and if there is an excessive capacity of Crane-1 empty container loading crane, the full container loading system reduces its full container loading gap by using this excessive capacity. After utilizing this excessive capacity the loading capacity increases and the full container loading gap declines. “Effective Total Full Container Capacity at A” is the full container loading capacity that Crane-1 ‘s excessive loading capacity is included.

“Filling Gap at A” is the gap between the “Desired Filling Rate at Harbor A” and the “Filling Rate at A According to the Crane Capacity and Demand”; i.e. this gap denotes the volume of shipments rejected due to capacity restrictions in the harbor. The elimination for shipments is done according to priorities of the shipment directions. If there is a gap, i.e. if some shipments have to be eliminated, the elimination begins with the demand for transportation which should be shipped to the harbor having the last priority. This calculation is a kind of gap allocation. If there is a gap in loading capacity, the gap is allocated according to the shipment direction priorities. Route A-B-C has the 3<sup>rd</sup> priority in harbor A. Therefore, if there is a gap in container loading capacity, the elimination begins with route A-B-C. Secondly, if there is still a gap, then the remaining gap is allocated to the route having the second priority. Lastly, the remaining gap is allocated to the route having the first priority. This calculation has the main purpose of rejecting or postponing minimum volume of demand of shipment for the route having the first priority.

Effective demand is the demand after all the calculations and planning, eliminations and rejections are done. “Effective Demand” is calculated by subtracting the volume of the rejected or the postponed demand from the initial demand of each direction. The demand in initial state for each route is converted into a ratio. The rejected or postponed demand is calculated as a ratio, too. “Ratio Utilized from A-B-C Route”, “Ratio Utilized from Route A-B”, “Ratio Utilized from Route Direct A-C” denote the rejected amount of the demand as a ratio.

Consequently, Effective Demand A-B-C” is equal to ‘Desired Containers to Be Filled at Harbor A’\*(Ratio of Demand A-B-C'-Ratio Utilized from A-B-C Route).

#### **4.6.4 MODULE-4 Ship Capacity Effect on Full Container Loading Planning**

Firstly, the number of containers and their average weight is calculated according to each shipping direction. Secondly, the empty container shipment plan is done according to the empty container shipment demand sent by the other harbors. Thirdly, the full container loading is done. In **MODULE-3** the demand for freight shipment was reduced by rejecting or postponing some shipments according to the capacity limits and restrictions. Even though having the capacity to fill the containers, if the company doesn't have enough loading capacity to load the containers to the ship, the company doesn't accept the amount that cannot be loaded to the ship. That is to say that the company doesn't keep full containers on the container terminal. The company accepts the demand that can fill into the containers and load to the ships on the same day.

In **MODULE-4** one capacity constriction is added to the model. Until now, the capacity from work and equipment, the loading capacity of the cranes and the level of the empty container inventory in the harbor had caused constrictions on the filling and loading operations. Capacity of the ship berthing at the harbor is creating another restriction on the model with **MODULE-4**.

It is assumed that all the ships sailing and berthing in the model have 3,000 container capacity. As explained before, on each harbor there are three main shipping directions.

While harbor A is the origin harbor for the shipping direction of A-B-C, B-C is the continuation shipping direction of A-B-C. Firstly, in harbor A the demand for empty and full container shipments is loaded to the ship sailing for the direction of A-B-C. Harbor A is the origin harbor of route A-B-C. While loading the demand to the ships, the capacity of the ship has a restriction on the loading operations and the loading operations are done according to these capacity factors in the origin harbor. When the ship sailing from the route A-B-C berths at the harbor B, the number of the containers that can be loaded to the ship in harbor B is confined with the remaining capacity of the ship loaded in the harbor A for the route A-B-C. If 1,000 containers were loaded to the ship for A-B-C direction in harbor A, and if the sailing time is 17 days from harbor A to harbor B, the capacity of the ship that the containers can be loaded in harbor B is the remaining ship capacity of A-B-C loaded in harbor A with a 17 day delay, i.e. the ship which has 2,000 remaining container loading capacity sailing from harbor A is the capacity that can be used 17 days later when the ship berths in harbor B. Therefore, a delay information function of 17 day delay is created for this assumption.

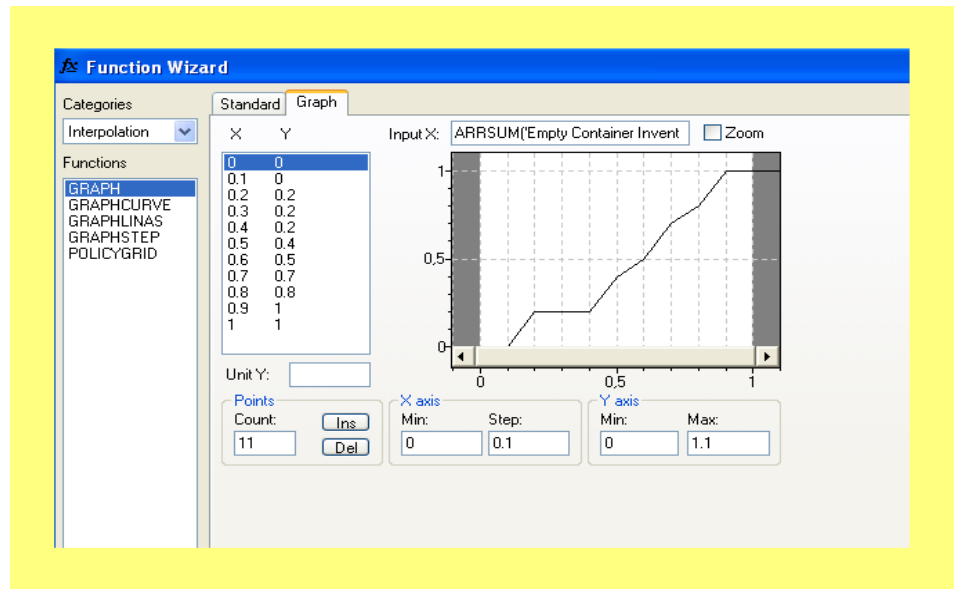
In **MODULE-3** the demand for freight transportation was reduced and adjusted according to the crane, work and loading capacities and the adjusted volume of the demand for freight shipment was named as “Effective Demand ...” If the loading takes place on the origin harbor, for instance for A-B route in the harbor A, the variable of “Capacity Allocated for Full Containers for A-B Route After Ship Capacity Calculation” compares the variable of “Effective Demand A-B” to the variable of “Ship Capacity Graph for A-B Route” and “Capacity Allocated for Full Containers for A-B Route After Ship Capacity Calculation” is the minimum value of this comparison. “Capacity Allocated for Full Containers for A-B Route after Ship Capacity Calculation” is the final decision in the number of filling and loading full containers. The variable of “Full Container Capacity Allocated for A-B Route” is exactly the same variable of “Capacity Allocated for Full Containers for A-B Route After Ship Capacity Calculation” that named differently.

After the final calculation is done for the full container loading operations, a planning for the empty container loading operations begin. In **MODULE-2**, the pre-planning for the empty containers was done. The calculated pre-planned variables were named as “C1A Capacity Allocated for A-B-C Route”, “C1A Capacity Allocated for A-B Route” and etc... In **MODULE-4** the ship capacity effect and the empty container level effect on the empty container loading operations are created. The full container loading planning is done the remaining capacity of the ship is allocated for the empty containers. Another priority is created here. Shipping full containers is our priority and then the demand for empty container transportations is shipped according to the remaining capacity. The variable of “Remaining Ship Capacity for Empty Containers for A-B Route” is calculated by subtracting the number of the full containers loaded to the ship from the “Ship Capacity”. The variable of “Capacity Allocated for Empty Containers for AB Route After Ship Capacity Calculation” compares the variable of “Remaining Ship Capacity for Empty Containers for AB Route” to the variable of “C1A Capacity Allocated for A-B Route” and chooses the minimum value. The remaining capacity of the ship for the empty containers is smaller than the pre-planned “C1A Capacity Allocated for A-B Route” another elimination for the demand for sailing empty containers is done by reducing the empty container demand for transportation according to the remaining ship capacity.

The effect of the empty container level on empty container planning which is created as a table function in **MODULE-7** is used in **MODULE-4**. The effect of the empty container inventory level on empty container loading is named as “Effect of Empty Container Inventory at A on



Shipping Empty Containers to the Other Harbors”. The empty container inventory declines to a critical level, the empty container shipment is reduced.



**Figure - 4.59**  
*The Effect of the Empty Container Level On Empty Container Planning*

As demonstrated on **Figure – 4.59** the empty container inventory level declines to 80%, the empty container shipment is reduced 20%. The empty container shipment is reduced to 70%, 50%, 20% and to 10% according to the empty container inventory level. If there is no empty container in the inventory, no empty container shipment is done.

#### **4.6.5 MODULE-5 Full Container Unloading Planning**

**MODULE-5** is consisted of two sub-modules: “Full Container Unloading Pre-Planning at Harbor A”, “Full Container Unloading Planning at A” (According to the Expected Full Container Arrivals)

The full container loading planning is done, the empty container loading planning begins. As explained before, Crane-5 and Crane-6 have an unloading capacity of 250 containers per day. Capacity of “Crane-4 Unloading” crane is equal to the excessive capacity of Crane-4 loading. Therefore, calculating the excessive loading capacity is considerably important. In the second sub-module, the unloading capacity of each unloading crane is calibrated according to the expected arrivals of full containers. The capacity allocated for each crane is reduced once more by this calibration.

In the part of 4.2.3 it was explained that all the burden and excessive capacity is shared equally among the cranes. “Total Full Container Loading Capacity at A” is calculated by cumulating the three loading cranes’ capacities. “Allocated Total Loading Capacity at A” is calculated by adding the excessive capacity of Crane-1 empty container loading to the “Total Full Container Loading Capacity at A”. As explained previously this was the pre-full container loading planning phase. The ship capacity, work and equipment capacity were taken in to consideration, and the demand was reduced or adjusted according to these capacity factors. “Total Excessive Loading Capacity is calculated by subtracting the adjusted final loading capacity from the “Allocated Total Loading Capacity at A” and this excessive capacity is allocated equally among the three loading cranes once more to determine the Crane-4 unloading capacity. The excessive capacity of Crane-4 is the C-4 Unloading crane’s unloading capacity.

“Total Full Container Unloading Capacity at A” is the cumulated capacities of Crane-4 unloading capacity, Crane-5 and Crane-6 unloading capacity.” Total Number of Full Containers Expected to Arrive at A” denotes the expected total number of full containers from the other harbors. “Unloading Capacity Gap at A” is the gap between these two variables. Moreover, the excessive capacity of crane-7 is calculated according to the volume of the empty containers expected to arrive and according to the capacity of C-7 empty loading crane. Crane-7 has an excessive capacity, “Unloading Capacity Gap at A” is reduced by utilizing the excessive capacity of Crane-7. Variable of “Utilized Excessive Capacity from C7A by Unloading Crane” fulfills this function. The excessive capacity of Crane-7 is allocated equally among the unloading cranes. “Total Extra Capacity Used for Each Crane for Unloading Operation at A from C7A “denotes the allocated excessive capacity of Crane-7 among the three unloading cranes. The equally shared capacity is added to each unloading crane’s unloading capacity. The effective unloading capacity of each crane is created by adding the equally shared excessive capacity to the unloading capacity of each unloading crane.” Effective C5A Capacity”, “Effective C6A Capacity”, “C4A Effective Unloading Capacity after Excessive Capacity Utilization” are the effective capacity variables of each unloading crane in the harbor A.

In the second sub-module of Full Container Unloading Planning at A (According to the volume of expected full container arrivals), the expected volume of full containers to arrive and the excessive capacity of Crane-7 are classified according the shipping directions. The each classification due to the shipping routes are converted into ratios. The ratios are created according

to the “Expected Total Number of Arrivals”. In harbor A, the arrivals are expected from C-B-A, B-A and C-A routes. The volume of the expected container arrivals from C-B-A takes place as number “5” in the array division of the C-B-A flow. “Ratio of Expected C-B-A” is created by the ratio of the expected amount of arrivals from C-B-A route to the “Expected Total Number of ArrivalsTotal” which demonstrates the expected amount of arrival in total. The same calculations are done for each container arrivals coming from each arrival shipping route. The excessive capacity of Crane-7 allocation among the three arrival directions is done according to the ratio of each expected number of containers. For instance, if 30 % of the total arrivals are the containers from C-A route, the 30% of excessive capacity is allocated to the arrivals from C-A shipping direction.

The effective capacity of each crane is classified according to the shipping directions by multiplying each ratio with the effective capacity of each unloading crane. Variables of “C5A Capacity Allocated for C-A Expected Demand”, “C5A Capacity Allocated for B-A Expected Demand”, “C5A Capacity Allocated for C-B-A Expected Demand” denote the classification of “Effective Capacity of C” according to the shipping routes. For instance, “C5A Capacity Allocated for C-A Expected” is calculated by “Demand Ratio of Expected C-A” \* “Effective C 5 A Capacity”. These calculations are done for each unloading crane and each of these variables are the outcomes of the final container unloading planning.

#### **4.6.6 MODULE-6 Empty Container Unloading Planning at A**

In **MODULE-6** the capacity of C-7 empty container unloading crane is allocated and classified according the expected arrivals and shipping routes. In **MODULE-5** the excessive capacity utilized from Crane-7 by each full container unloading crane was tracked and classified according to arrivals and the shipping directions. The same categorization is done in **MODULE-6** as well. C-B-A, C-A and B-A are the directions that harbor A receives containers from. The containers arriving from C-B-A route takes place as number “2” in the array division of “Empty Container Flow Rate from B to A and C”. The containers arriving from B-A route takes place as number “6” in the array division of “Empty Container Flow Rate from B to A and C” and the containers arriving from C-A route takes place as number “1” in the array division of “Empty Container Flow Rate From C to A”. The variable of “Ratio of Expected C-B-A at A”, is created by the ratio

of the volume of the expected container arrivals coming from C-B-A shipping direction to the total volume of the expected empty containers coming from all three shipping directions. The same calculations are done for each container arrival coming from the shipping routes. (“Ratio of Expected B-A at A” and “Ratio of Expected C-A at A”). The capacity of Crane-7 is categorized and allocated according to the shipping routes by multiplying each of these ratios with the capacity of Crane-7. “Capacity of C7A Allocated to the Expected Empty Container from CBA Route” is the capacity of Crane-7 allocated for the empty arrivals coming from the shipping route of C-B-A. “Capacity of C7A Allocated to the Expected Empty Container from B-A Route” is the capacity of Crane-7 allocated for the empty arrivals coming from the shipping route of B-A and “Capacity of C7A Allocated to the Expected Empty Container from CA Route” is the capacity of Crane-7 allocated for the empty arrivals from the shipping route of C-A.

Consequently, the full container loading, the empty container loading, the full container unloading and the empty container unloading planning are done in the first six modules until now.

#### ***4.6.7 MODULE-7 Filling Rate Planning at Harbor A***

The demand for freight transportation is converted into number of containers according to the dimension and carrying capacity of a container with **MODULE-1**. “Order Receive Rate at A” denotes the daily volume of the demand for the freight transportation received by the harbor. The received orders are evaluated and a planning facility is done. The evaluation and planning facility takes 1 day. Variable “Container Planning Time at A” denotes this planning time. During this time the full container loading, empty container loading, full container unloading and empty container unloading planning are done and the demand is adjusted to the capacity limits of the system. Some demands for transportation are rejected or postponed according to the capacity factors. The filling rate is determined according to the adjusted demand. “Order Execution Rate at A” denotes the number of containers loaded/unloaded in the harbor. “Desired Received Orders at A” represents the desired number of orders. The demand for transportation is exogenous.

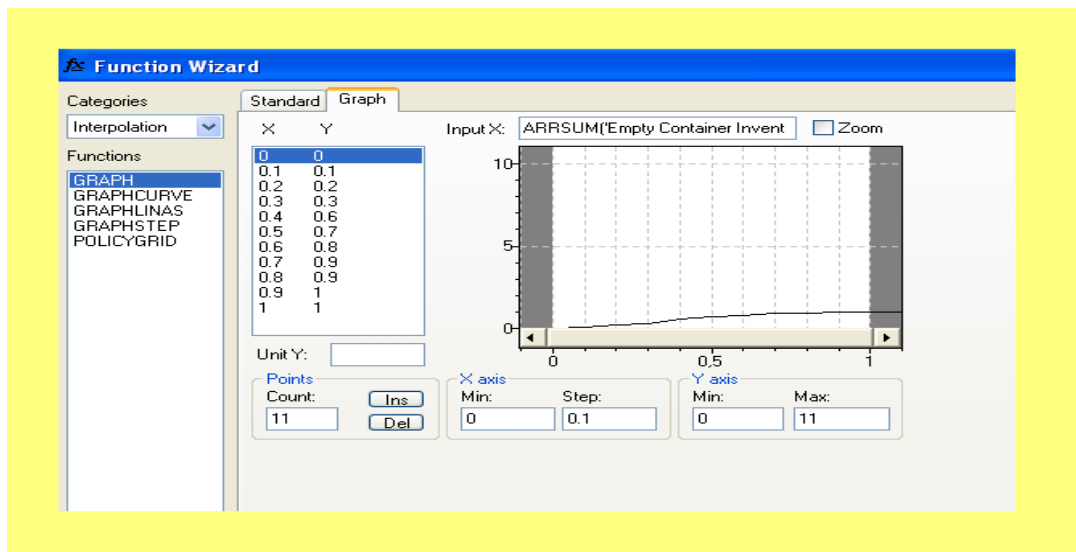
The orders are received, a 1 day planning facility is done and the containers are filled and loaded according to the capacity limits. The stock of “Planned Container Orders to Transport at A” represents the number of orders not fulfilled yet, i.e this stock represents the orders rejected or postponed.

In **MODULE-3**, it is explained that the demand is accepted according to the capacity factors; not all the orders received can be fulfilled; therefore some shipping orders are rejected or postponed. The capacity factors are:

- Filling Capacity from Work and Equipment at A
- Effective Filling Capacity from Empty Containers
- Effective Total Full Container Capacity at A.

It is assumed that there are 30 container stuffing stations in the harbor and the harbor works 24 hours. Each container “Filling Operation Time” is 0.01388889 day, i.e it takes 20 minutes to fill a container. “Filling Capacity From Work and Equipment at A” is 2,160 containers per day.

Moreover, it is assumed that the level of empty container inventory has an effect on container filling and loading operations. The main idea is: the empty container inventory is reduced to some critical level, the container filling and loading operations slow down due to the critical inventory levels. A non-linear effect is created with the variable of “Effect Of Empty Containers On Capacity”.



**Figure – 4.60**  
*Effect of Empty Container Inventory Level in the Harbor on the Container Filling Operations*

**Figure – 4.60** shows that the inventory level reduced 20% , the filling rate reduced 10% and the inventory level declined to 60% of the desired inventory level, the filling rate is reduced 20% and etc... The variable of “Effective Filling Capacity from Empty Containers” is created according to the effect of empty container inventory level.

“Effective Total Full Container Capacity at A” which is calculated by the total loading capacity of Crane-1, Crane-2, and Crane-3 and Crane-4 loading is explained in detail in **MODULE-3**.

“Filling Rate at A According to the Crane Capacity and Demand” is the minimum value of the variables of “Sum Filling Capacity from Work and Equipment at A”, “Desired Filling Rate at Harbor A”, and “Effective Filling Capacity from Empty Containers”.

A kind filtration methodology is used while creating the simulation model. The demand and the flows are reduced step by step according to the capacity restrictions; by this way the simulation model is rendered more realistic step by step.

Consequently, “Filling Rate at A” is the minimum value of “Filling Rate at A According to the Crane Capacity and Demand” and “Calculated Allocated Capacity after Evaluating Ship Capacity”. The ship capacity is applied as the last restriction to the filling rate.

The desired number of containers in the harbors is calculated according to the area factors. It is assumed that the average dwelling time of a container is 10 days, and the stacking area is determined according to each container’s ground area and average stacking height. The peak factor is assumed to be 0.75.

#### **4.6.8 MODULE-8 Harbor Productivity**

Harbor productivity is measured by two means:

- The Productivity Calculated with the Cumulated Loaded/Unloaded Tonnage in the Harbor
- The Productivity Calculated with the Cumulated Number of Containers Loaded/Unloaded in the Harbor.

The total freight loaded/unloaded by each loading/unloading crane is calculated annually. The annual throughput is calculated by two means: as number of containers and as tonnage. Each container’s loaded/unloaded freight is categorized according to the shipping directions.

First of all, the cumulated number of loaded/unloaded freight is calculated as unit of <<ton>>.

The excessive capacity utilization from the Crane-1 and Crane-7 is calculated by subtracting the excessive utilized amount from each Crane of Crane-2, Crane-3, Crane-4 loading, Crane-4 unloading, Crane-5 and Crane-6 and adding the utilized amount to the crane the excessive capacity utilized from. Exemplifying this calculation would be more conducive to understand. For instance, the demand for empty container shipment is 130 containers, and the full container loading capacity gap of Crane – 2, Crane – 3 and Crane –4 is totally 60 containers. The excessive

capacity of Crane-1 is 120 container (Crane-1 Empty Container Loading Capacity(250)-The demand for empty container loading(130) = 120 container excessive empty container loading capacity). The gap in the loading capacity is 60 containers. There is enough excessive capacity to close the gap in the full container loading capacity and the system allows the full container loading cranes to utilize the excessive capacity. The excessive capacity utilized from Crane-1 is totally 60 containers; i.e. each crane of Crane-2, Crane-3 and Crane-4 Loading utilizes 20 container loading capacity of Crane -1; i.e. Crane - 1 reduces each loading cranes' burden 20 containers. In total, Crane-1 assisted in the full loading cranes by loading 60 full containers. If Crane-1 excessive empty container loading capacity is 120 containers, it means that Crane-1 loaded 130 empty containers before. Crane-1 assisted the loading cranes in loading 60 full containers as well. Therefore Crane-1 loaded 130 (Empty)+60(Full) containers.

The “Cumulated tonnage by Crane 1 A Hatch” is calculated by each variable of “Excessive Capacity of C1A Utilized A-B Route”, “Excessive Capacity of C1A Utilized by A-B-C Route”, “Excessive Capacity of C1A Utilized by Direct A-C Route”. “C 1 A Empty Container Loading Rate at A” doesn't add anything; because “C 1 A Empty Container Loading Rate at A” is an empty container flow and empty containers are accepted as 0 ton. The only weight d loaded by crane-1 is the weight when Crane-1 accomplishes its job earlier due to the lack of empty container demand and when crane-1 is appointed to assist in the other loading cranes in sharing their loading burden.

“Cumulated Tonnage by Crane 2 A Hatch” is calculated by each container flow being shipped to and by each container's average weight. “C 2 A Loading Rate” is the loading rate of Crane-2. Crane-2 is loading and sending containers to three different directions: A-C, A-B and A-B-C. The function enabling us to calculate each container's average weight according to the shipping direction is created in **MODULE-1**. To get the cumulated tonnage, the number of containers sent to each direction are multiplied with each container's average weight. Moreover, if Crane-1 assisted Crane-2 in loading operations, i.e if Crane-2 utilized excessive capacity from Crane-1, the amount of the excessive capacity utilized by Crane-2 is subtracted from the total cumulated tonnage of Crane-2 and added to the total cumulated tonnage of Crane-1. All the other cranes' total cumulated tonnage is calculated by the same methodology. As explained previously, all the excessive capacities and gaps are shared equally among the cranes. Therefore, excessive capacity

utilized from Crane-1 by each loading container is calculated by dividing the total excessive capacity by the number of cranes.

“Cumulated Tonnage by Crane 3 A Hatch” is calculated by each container flow being shipped to and by each container’s average weight. “C 3 A Loading Rate” is the loading rate of crane-3. Crane-3 is loading and sending containers to three different directions: A-C, A-B and A-B-C. The function enabling us to calculate each container’s average weight according to the shipping direction is created. To get the cumulated tonnage, the number of containers sent to each direction are multiplied by each container’s average weight. Crane-1 assisted Crane-3 in loading operations, i.e if Crane-3 utilized excessive capacity from Crane-1, the amount of the excessive capacity utilized by Crane-2 is subtracted from the total cumulated tonnage of Crane-2 and added to the total cumulated tonnage of Crane-1. The same calculation is done for the Crane-4 loading as well.

The “Cumulated tonnage by Crane 7 A Hatch” is calculated by each variable of “Total Extra Capacity Utilized for B-A Route fromC7A”, “Total Extra Capacity Utilized for C-A Route fromC7A”, “Total Extra Capacity Utilized for C-B-A Route fromC7A”. “C 7 A Crane Unloading Rate as tonnage” doesn’t add anything; because “C 7 A Unloaded Empty Container Rate at A” is an empty container flow and empty containers are accepted as 0 ton. The only weight unloaded by Crane-7 is the one when Crane-7 accomplishes its job earlier due to the lack of empty container arrivals and when Crane-7 is appointed to assist the other loading cranes in sharing their loading burden.

“Cumulated Tonnage by Crane 6 A Unloading Hatch “is calculated by each container flow being shipped to and by each container’s average weight. “C 6 A Crane Unloading Rate” is the unloading rate of Crane-6. Crane-6 is unloading containers coming from three different directions: C-A, C-B-A and from C-B. The function enabling us to calculate each container’s average weight according to the shipping direction is created in *MODULE-1*. To get the cumulated tonnage, the number of containers arriving from each direction are multiplied by each container’s average weight. For instance, Crane-7 assisted Crane-6 in unloading operations, i.e if Crane-6 utilized excessive unloading capacity from Crane-7, the amount of the excessive capacity utilized by Crane-6 is subtracted from the total cumulated tonnage of Crane-6 and added to the total cumulated tonnage of Crane-7. The same calculations are done for the Crane-4 unloading and Crane-5 as well.



As for calculating the productivity of the harbor according to the number of containers loaded/unloaded, “Cumulated Number of Containers by Crane 1 A Hatch” is the cumulation of the variables of “C 1 A Empty Container Loading Rate at A”, “Excessive Capacity of C1A Utilized A-B Route”, “Excessive Capacity of C1A Utilized by A-B-C Route”, “Excessive Capacity of C1A Utilized by Direct A-C Route”.

“Cumulated-Number of Containers by Crane 2 A Hatch” is calculated by subtracting the variables of “Excessive Capacity of C1A Utilized A-B Route”, “Excessive Capacity of C1A Utilized by A-B-C Route”, “Excessive Capacity of C1A Utilized by Direct A-C Route” from total number number of full containers loaded by Crane-2.

“Cumulated-Number of Containers by Crane 3 A Hatch” is calculated by subtracting the amount of loading work done by Crane-1 from the total number of full containers loaded by Crane-3. As explained previously, each excessive capacity utilization by each loading crane is the loading operation done by the Crane-1. Crane-4 loading crane’s annual throughput as number of containers is calculated with the same methodology.

Crane-7 is assisting the unloading cranes of Crane-4 unloading, Crane-5 and Crane-6 if there is an excessive capacity of Crane-7 and there is a gap in unloading capacity. To calculate the cumulated annual throughput of Crane-7 unloading, the excessive capacity utilized by each unloading crane from Crane-7 is added to the total number of containers loaded/unloaded by Crane-7, i.e. “Cumulated Containers by Crane 7 A Hatch” is the cumulation of the variables of “C 7 A Unloaded Empty Container Rate at A”, “Total Extra Capacity Utilized for B-A Route fromC7A”, “Total Extra Capacity Utilized for C-A Route fromC7A”, “Total Extra Capacity Utilized for C-B-A Route fromC7A”.

The productivity of the harbor is calculated in two different ways: the productivity calculated with tonnage and the productivity calculated with the number of containers. While calculating the productivity in the unit of “Ton” the number of containers are multiplied with “Tonnage Per Container to ... Route”.

Loading cranes are installed on Hatch-1 and the unloading cranes are installed on Hatch-2. “Max Container Loading Capacity of C 1 A” is calculated by multiplying the daily maximum container loading capacity with 365 (365 days), i.e it represents the maximum number of containers that can be loaded by Crane-1 annually. “Max Container Loading Capacity of C 2 A” and the other loading/unloading crane’s annual maximum capacity is calculated in the same way. Each hatch’s

annual loading/unloading capacity is calculated and named as “Max. Container Capacity of Hatch-1 A” and “Max. Container Capacity of Hatch-2 A” according to the annual maximum loading/unloading capacities of loading/unloading cranes.

Total cumulated throughput of the harbor is defined by cumulating each crane’s cumulated annual throughput and named as “Cum. Annual Throughput as Number of Containers at A”. Moreover, each loading/unloading container’s cumulated annual throughput is divided by the “TIME” and the average number of containers loaded/unloaded by each loading/unloading crane is defined and named as “Average Number of Containers for C 1 A per Day”, “Average Number of Containers for C 2 A per Day” and etc...The cumulated value of the average number of containers loaded daily by each loading crane is named as “Number of Containers per HATCH 1 per day at A”. The cumulated value of the average number of containers loaded daily by each unloading crane is named as “Number of Containers per HATCH 2 per day at A”.

The ratio of “Number of Containers per HATCH 1 per day at A” to the “Max Container Capacity of Hatch-1 A” is the “Average Productivity of Cranes at HATCH-1 A as number of Containers”.

“Average Number of Containers under operation per Hatch per day” is the average of “Number of Containers per HATCH 1 per day at A” and “Number of Containers per HATCH - 2 per day at A”.

“Average Number of Containers per ship per day” is calculated by “ multiplying the “Average Number of Hatches Working at A” by the “Average Number of Containers under operation per Hatch per day”.

“Total Number of Ships Arrived Sailed at Harbor A” is the total number of ships sailed and berthed in the harbor. Dividing the “Cum. Annual Throughput as Number of Containers at A” by the “Total Number of Ships Arrived Sailed at Harbor A” the average number of containers carried per ship is calculated. Variable of “Average Throughput per ship as Container” represents this calculation.

“Average Service Time as number of Containers” is calculated by dividing “Average Throughput per ship as Container” by “Average Number of Containers per ship per day”.

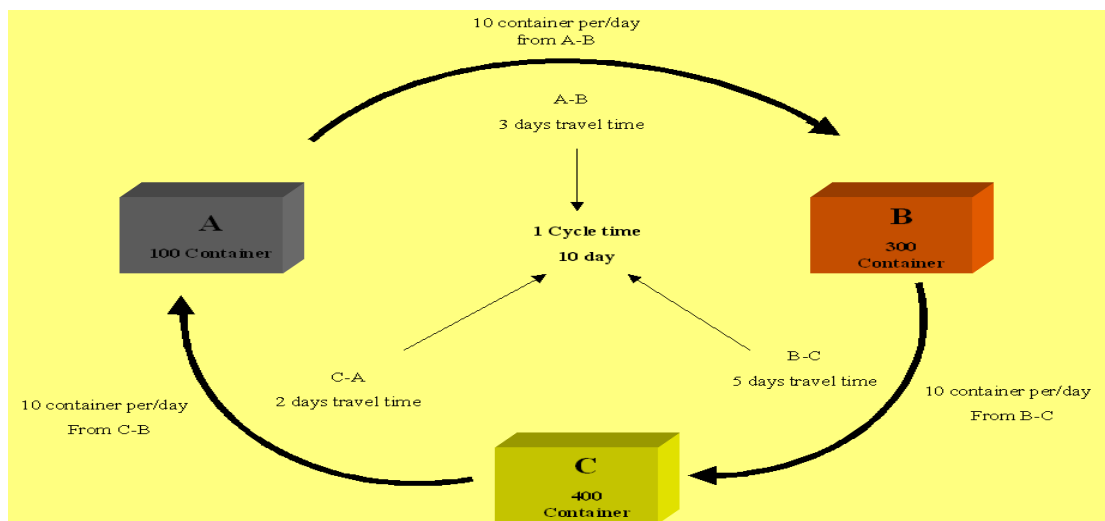
The ratio of each ship’s container capacity to the to the total loading/unloading capacity of the harbor gives us the maximum number of ships that can sail and berth to the harbor daily. The variable of “Number Ships that can berth and sail per day” represents this calculation and

“Occupancy Ratio” is the ratio of “Average Service Time as number of Containers” to the “Number Ships that can berth and sail per day”.

#### 4.6.9 MODULE-9 Idle Container Ratio

In **MODULE-9** the idle ratio of containers is calculated. The assumption is based on the idea: if a container is moving it is doing its job; therefore, as long as a container is moving it has a productivity. But sometimes the containers are moving full and sometimes they are moving empty. In the simulation model, the idle time is calculated according to the both empty container movements and according to the full container movements. Two kinds of calculations are done due to empty container movements and full container movements; but the policy development phase and analyses are done according the full container movements; i.e. the container flowing full is assumed as productive while developing policies.

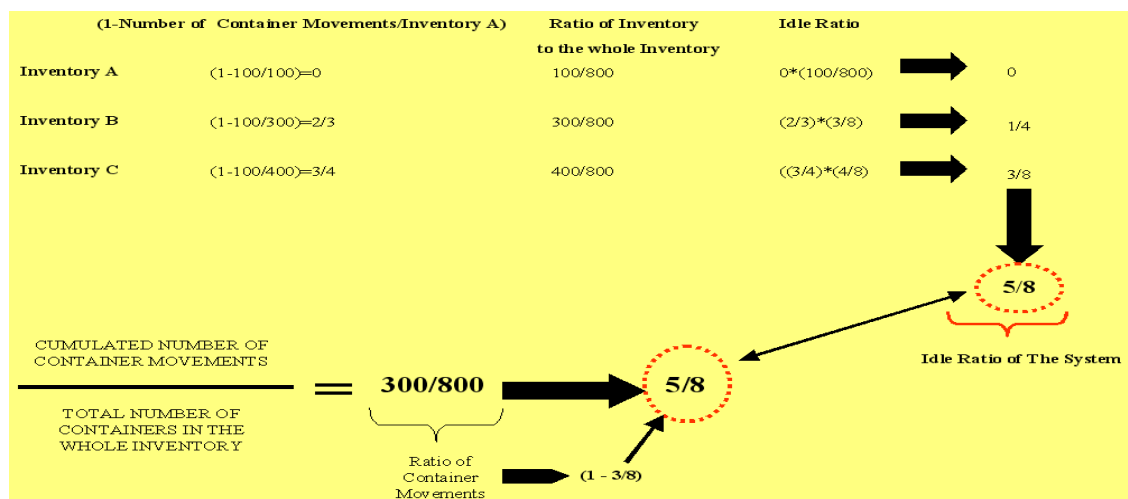
Firstly, the cumulated number of containers moved from the three harbors of A, B and C in a specific period are cumulated. It is expected that the ratio of the number of the containers moved (“Cumulated Number of Containers Moved from the three Harbors”) to the total number of the containers on the three harbors gives us how many containers are currently idle. The whole empty container flows from three harbors are cumulated and named as “Cumulated Number of Empty Shipped Containers” and the containers moved full are cumulated and named as “Cumulated Number of Containers Shipped Full” and the variable of “Cumulated Number of Containers Moved from the three Harbors” is created by cumulating these two variables.



**Figure - 4.61**  
**One Cycle Time**

It would be conducive to exemplify the assumptions in simulating. To illustrate, there are three container inventories A, B and C. Inventory A has 100 containers, B has 300 containers and C has 400 containers. The travel time between these inventories are showed on the **Figure - 4.61**. It is assumed that the system is in equilibrium. The daily demand from A-B is 30 containers per day, from B-C the demand is 50 containers/day and from C-A the demand is assumed to be 20 containers/day. Under these conditions, the daily containers moving from each harbor is 10 containers per day and the system is in equilibrium.

Under these assumptions 1 container completes 1 cycle in 10 days. In 10 days 100 containers from A-B, 100 containers from B-C, 100 containers from C-A move. In 1 cycle time of 10 days, totally 300 containers movements occur. In 10 days 100 containers leave from A, 100 containers leave from B and 100 containers leave from C. If we the divide the total number of containers shipped from each by the each container inventory, it demonstrates that 100 containers of inventory A flowed in 1 cycle time of 10 days. 100% of the containers at A are used according to the ratio of 100/100, i.e. there is no idle container at A. 100 containers of 300 container inventory B flowed in 1 cycle time, i.e 1/3 of the inventory flowed; rather 2/3 percent of the container inventory of B is idle. As for inventory C, 100 containers of the inventory flowed, it means that 100/400 containers were not idle, and 300/400, i.e ¾ percent of this inventory is idle. Inventory B constitutes 300/800 part of the total inventory of A, B and C, inventory C constitutes 400/800 of the total inventory and inventory A constitutes 100/800 of the total inventory. As demonstrated on **Figure - 4.62** the Idle Ratio of the system is calculated by cumulating each idle ratio of container inventory.



**Figure - 4.62**  
**The Idle Container Ratio**

The cycle times were classified according to the sort of shipping directions. (*See Chapter - 4, 4.4.1 One Container Cycle*). The demand for freight transportation is received the containers are shipped to a direction for delivery. As explained before, each shipping direction has a certain cycle time. For instance, if a container is sent to A-B direction, this container is expected to be ready in the harbor 50 days later. If a container is sent to the direction of A-B-C, this container is expected to be back in 75 days. “Average Cycle Time in the system” is calculated according to number of demands for the freight transportation and the cycle time of each demand. A cumulated number of container days are calculated by multiplying the volume of the demands for transportation by the cycle time of each container for transportation route. Each direction’s cumulated number of container days are named as “Cumulated Number of Containers Flowing at A”, “Cumulated Container Days for Full Flows A-C”, “Empty Containers Flows from B to C” and etc...All these cumulated container days of each route are cumulated once more and “Cumulated Number of Container Days at A” is calculated. Moreover, all the container movements are cumulated for each harbor and named as “Cumulated Number of Containers Flowing at A”, “Cumulated Number of Containers Flowing at B”, “Cumulated Container Days for Full Flows B-C”. Dividing the cumulated number of container days of each harbor by the cumulated number of container movements of each harbor, “Average Cycle Time at A”, “Average Cycle Time at B”, “Average Cycle Time at C” are calculated. The average value of these three values is the “Average Cycle Time in the system”.

“Average Number of Cycles Per Full Container” is based on the assumption that “Only a full container moving is productive”. It represents the ratio of “Cumulated Number of Containers Shipped Full” to the “Total Number of Empty Containers on the Harbors “. “Average Number of Cycles Per Full Container” represents the average number of cycles completed by full containers.

“Average Number of Cycles According to Both Full & Empty Containers” represents the average number of cycles calculated according to all container movements regardless of a container moving is full or empty. “Maximum Number of Cycles per Container” represents the number of maximum cycles that can be done according to the desired situation.

“Average Productivity Level of Each Full Container” compares the value of “Maximum Number of Cycles per Container” to the “Average Number of Cycles Per Full Container”. The current number cycles done by full containers are compared according to the maximum number

of container cycles. This comparison represents the average productivity of a container according to the full container movements.

“Average Productivity Level of Each Empty and Full Container” compares the value of the “Maximum Number of Cycles per Container” to the “Average Number of Cycles According to Both Full & Empty Containers”. The current number cycles done by both empty and full containers are compared according to the maximum number of container cycles. This comparison indicates the average productivity of a container according to the both empty and full container movements.

The productivity value indicates how many times a container has moved, i.e how much the container is not idle.

#### 4.6.10 *MODULE-10 Empty Container Ratio*

In *MODULE-10*, a simple ratio is created. It was explained that the historical data shows that the empty container flow ratio is around 20%, i.e 20% of the container flows are empty container movements. The cumulated value of empty movements ratio to the cumulated value of full and empty container movements gives the “Empty Container Ratio Per Day”. “Cumulative Average Empty Container Ratio” is the cumulation of daily empty container ratio, i.e. it is the cumulation of “Empty Container Ratio Per Day”; and “Average Empty Container Ratio” is the average value of the empty container ratio. The empty container ratio is represented with the variable of “Average Empty Container Ratio” and all the analyses related to the empty container ratio are done according to this variable.

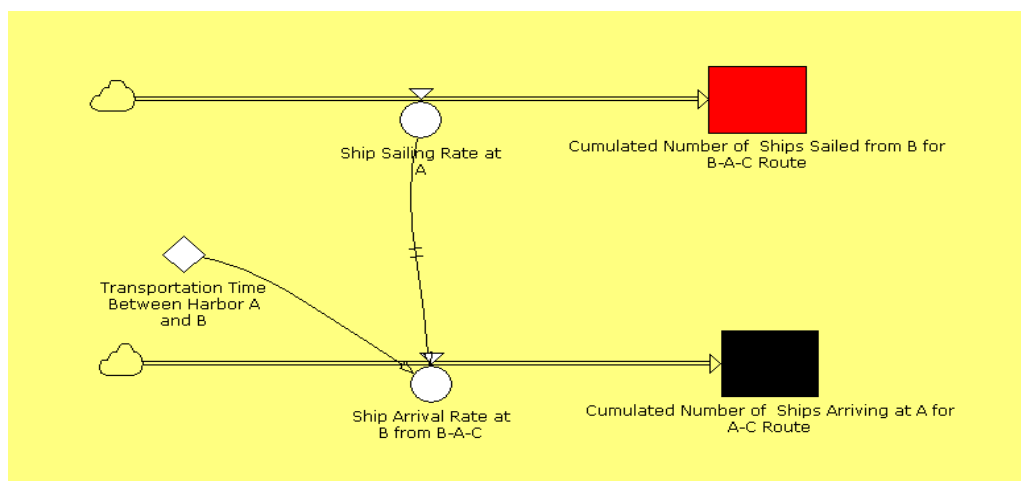
#### 4.6.11 *MODUL-11 Network Module at Harbor A ( Number of Ships Arriving & Departing)*

	DEPARTURE	ARRIVAL
HARBOR A	A-C	C-A
	A-B	C-B-A (2)
	A-B-C	B-A-C (1)
HARBOR B	B-A	C-B
	B-C	A-B
	B-A-C	A-B-C(1)
	–	C-B-A (1)
HARBOR C	C-A	A-C
	C-B	B-C
	C-B-A	B-A-C (2)
	–	A-B-C (2)

**Figure - 4.63**  
*Shipping Directions and Arrivals in the Harbors*

**Figure - 4.63** represents the arrivals and departures in the harbors. **MODULE-11** calculates the cumulated number of ships arrived and departed in the harbors. In this study only the productivity of harbor A is analyzed. Therefore, the assumptions and the illustrations are based on harbor A. The shipping directions include one or two berthings. For instance A-C shipping direction includes one departure from harbor A and one berthing in the destination harbor of B. The ship sailing for A-B-C direction departs from harbor A, berths at harbor B, sails from harbor B and berths in its destination harbor of Harbor C; i.e shipping direction of A-B-C includes 2 berthings. Harbor B is the first berthing of route A-B-C. Berthing at the destination harbor of C is the 2nd berthing of route A-B-C. Shipping directions of B-A-C and C-B-A include two berthings as route A-B-C. The numbers in the parenthesis in the shipping routes represent the number of berthings. For example, B-A-C (1) represents that the ship berthed on its first berthing harbor of A; i.e now the ship berthed at harbor A; but harbor A is not the destination harbor. The ships arriving at the destination harbors are represented as number 2, for example C-B-A (2), B-A-C (2) and etc... C-B-A(2) represents that the ship berthed in its 2nd harbor; i.e. the ship is in its destination harbor of harbor A.

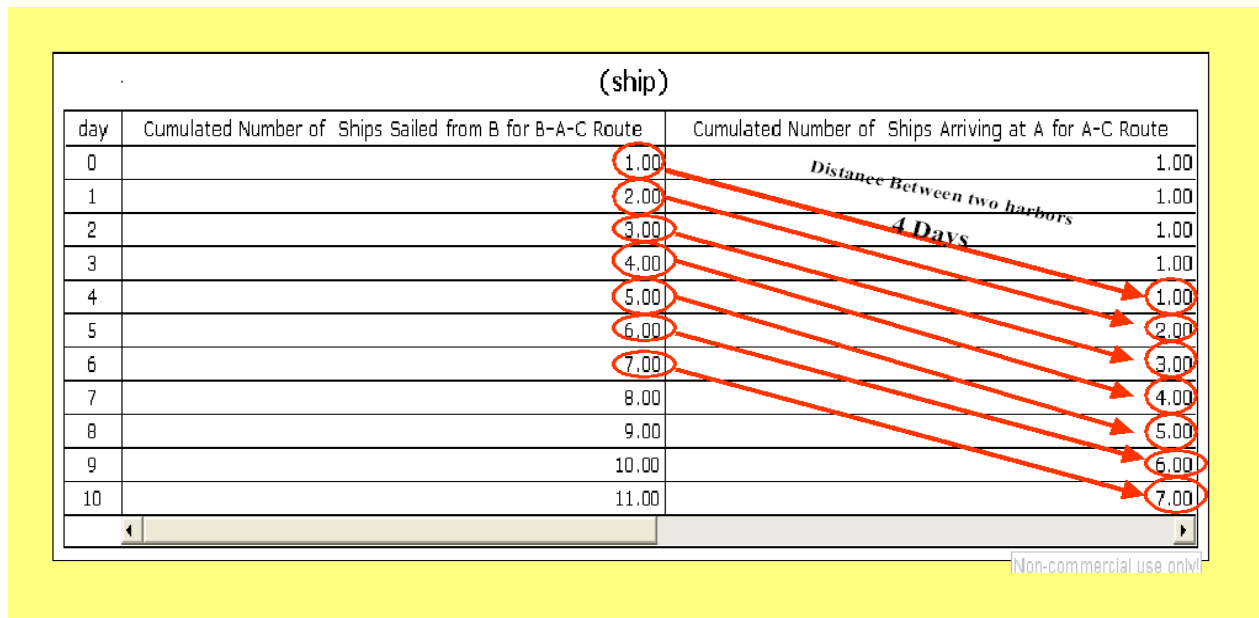
In harbor A, there are 3 arrival shipping directions and 3 departure directions. The departure shipping directions are A-C, A-B and A-B-C. The arrival directions are C-A, C-B-A and B-A-C. Route A-C originating from harbor A is the continuation of route B-A-C. Route B-A originating from harbor B is the continuation of route C-B-A. Route B-C originating from harbor B is the continuation of route A-B-C.



**Figure - 4.64**  
*The number of Ships Sailed and Arrived (Route B-A-C is Exemplified)*

**Figure - 4.64** shows the calculation of the number of the ships sailing from B-A-C and arriving at harbor A. Harbor A is the origin harbor of the shipping direction of A-B-C. The ship is loaded with the freight for A-C shipping direction at harbor A and sails. The remaining capacity of the ship loaded at harbor A for A-B-C direction determines the volume of the freight that can be loaded at harbor B for B-C direction. The capacity of the ship berthing at harbor B for B-C direction is the remaining capacity of the ship loaded at harbor A with a 17 day delay.

The ship sailing from harbor B for the route B-A-C arrives 17 days later at harbor A to load the freight for A-C route from harbor A. After the loading operations the same ship sails for A-C route from harbor A. It is assumed that the ship sailing from harbor B for B-A-C is the ship berthing 17 days later at harbor A to sail for A-C route from the harbor A. The assumptions in calculating the number of the arrivals and departures in the harbors are exemplified and simulated in a simple way. The travel time is assumed as 4 days in the simplified simulation on **Figure - 4.64** while the travel time from B to A is 17 days in the real conditions. It is assumed that everyday 1 ship is sailing from harbor B; i.e. the ship sailing from harbor B arrives at the harbor A on the 5<sup>th</sup> day. On the second day the 2<sup>nd</sup> ship is sailing from the harbor B and this ship arrives at the harbor A on the 6<sup>th</sup> day. The ship arrived at harbor A is the ship sailed 4 days ago from harbor B. **Figure - 4.65** justifies that the methodology in simulating the assumptions of the arrivals and sailings in the harbors is realistic and successful.



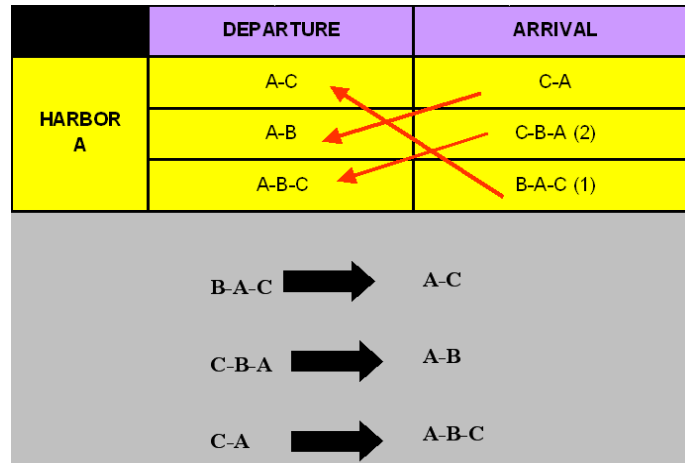
**Figure - 4.65**  
*Analysing the Simple Simulation Model Built on Figure -4.64 for the Assumption for Calculating the Number of Ships Arrived and Sailed in the Harbors.*



“Ship Capacity Graph of Ships for B-A-C Route” is created according to the assumption of each ship has a 3,000 container-carrying capacity. Containers are loaded according to this capacity. The ratio of the freight loaded to the ship capacity depicts how much per cent the ship is filled. The demand for transportation requires 1,500 containers and if the ship has a carrying capacity of 3,000 containers, the ship waits for 2 days in the harbor and at the end of the second day the ship sails or everyday 0.5 per cent of the ship sails. In both assumptions 2 days later the number of the ships sailing from the harbor is 1 ship. “Counting Ship at B for B-A-C Route” simulates this assumption. The variable of “Ship Departure Rate B-A-C” shows the number of ships sailing every day, “Cum. Number of Ships Sailed for B-A-C Route” is the cumulated number of ships sailed from the harbor B for B-A-C.

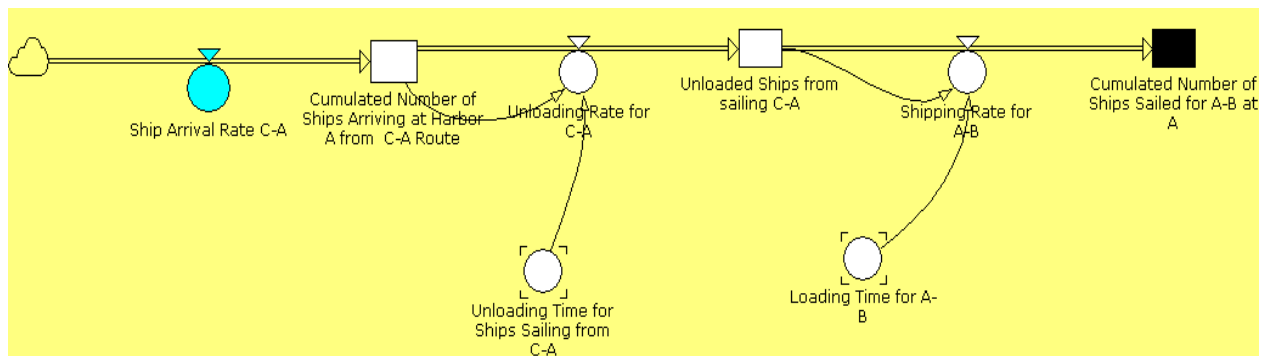
“Ship Arriving Rate from B-A-C” shows that the arrivals at harbor A is the 17 day delayed departures of harbor B; i.e. variable of “Ship Departure Rate B-A-C” with a 17 day delay. “Number of Ships waiting for loading operation” shows the number of ships berthed in the harbor A and waiting for the loading operations or undergoing the loading operations. The ship is in this stock as long as the loading operation continues. If the demand to load is high then the ship waits more in this stock. The ship completed the loading operation sails from the harbor and “Ship Departing Rate for A-C” represents the number of ships sailing daily from the harbor A. The variable of “Number of Ships Sailing from harbor A” is created on the assumption that number of ships in the ratio of the demand to the ship capacity sails everyday from the harbor. To illustrate, if the demand for transportation to A-C route is 1,375 containers per day and if the remaining capacity of the ship loaded in harbor B for B-A-C is 2,750 containers, then 1,375 containers per day divided by 2,750 containers per ship, i.e. 0.5 ships per day sails from the harbor.

“Cumulated Number of Ships Departed from Harbor A for A-C” is the cumulated number of ships sailed from the harbor. “Number of Ships arrived at A from B-A-C Route” is the cumulated number of ships arrived at the harbor A from harbor B.



**Figure - 4.66**  
*The Arrivals and Departures in Harbor A*

The ship sailing from B-A-C route arrives at harbor A and goes on sailing for A-C direction after loading the freight transported to A-C direction. The containers shipped from C-A and C-B-A arrive at their destination harbors. In real conditions the ship arriving at the destination harbor waits for new freight to load and sails again. **Figure - 4.66** is conducive in evaluating how much the model realistic. After berthing and unloading the freight, the ships sailing from the routes of C-A and C-B-A are vacant and there are two shipping directions the freight is shipped to: direction A-B and direction A-B-C. **Figure - 4.66** shows that arriving from C-A and C-B-A directions, the ships are appointed to transport new freight to the directions of A-B-C and A-C. Arriving at the destination harbors, ships sailing from route C-A and C-B-A go on sailing by loading the new demand from harbor A. **Figure- 4.66** shows that there is no vacant network in harbor. A



**Figure - 4.67**  
*Operations in the Harbor*

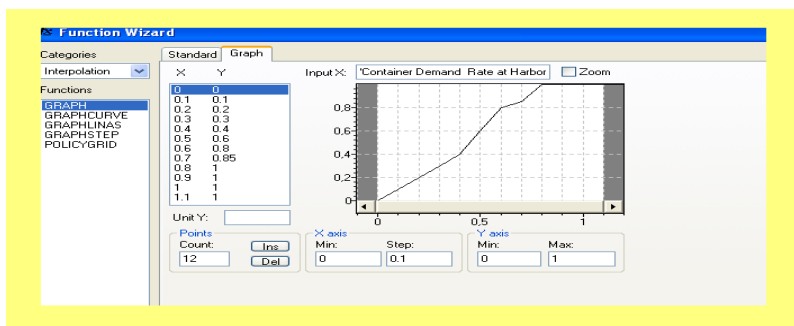
**Figure - 4.67** represents the process of the operations of a ship sailing from C-A route and arriving at its destination harbor A. Ship arrival rate is the 17 day delayed ship departing rate

of harbor C. The ship arrives at A from harbor C, the unloading operations begin. “Unloading Time for Ships Sailing from C-A” is calculated by dividing the value of the ship capacity sailing from C by the value of the number of containers unloaded. To illustrate, if daily 500 containers are unloaded and if the ship has 3,000 container capacity, it takes 6 days to unload the ship. The unloading operations are done, the ship sailing from C-A is allocated for the shipping direction A-B. Therefore, the ship is loaded with the freight transport to A-B direction. The loading time for A-B is calculated by dividing the ship capacity by the daily volume of demand for transportation for A-B route. The loading operations are done the ship sails from the harbor.

#### 4.6.12 MODULE-12 Inventory Level Effect on Transportation Selection Mode at Harbor A

There are three sorts of transportation modes in inland transportations: by rail, by barge and by truck. Each transportation mode’s capacity and transportation time was explained before. (*See Chapter – 4, 4.4.2 Inland Transportation Modes and Inland Transportation Capacity Features*) The effect of the container inventory of the harbors on the transportation mode selection is created by **MODULE-12**; i.e., if the container inventory reduced a critical level, the system chooses a faster transportation mode to transport containers from in land. Each inland transportation mode has a numeric effect of “1” on the inland container flows. The level of the container inventory reduces to a critical level, the inventory begins to affect each transportation mode by constricting the slowest transportation mode of transportation by barge. The container inventory reduces to its 85% level, the volume of the containers transported by barge is reduced 15% and the volume of the containers transported by truck is increased 15%.

A table function is created and named as “Effect of Container Demand on Inland Transportation Rate at A”. **Figure- 4.68** represents this non-linear relationship between the inventory level and transportation modes.



**Figure - 4.68**  
*Effect of Container Demand on Inland Transportation Rate at A*

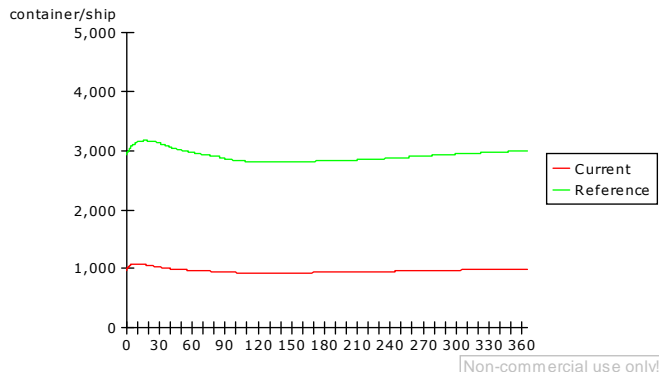




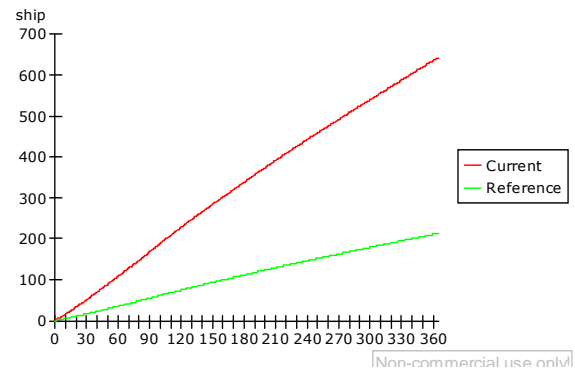
**Figure – 4.72** depicts that no container is loaded when the loading capacity is subjected to the extreme condition test. **Figure – 4.73** depicts that the container unloading operations go on until the containers in the inventories of “Unloaded Full Containers at A, B and C” are equal to ZERO and then the unloading operations stop.

#### 4.7.2 Sensitivity Tests

- **Capacity of Each Ship Reduced to 1,000 containers**



**Figure – 4.74**  
*Average Ship Capacity in the System*



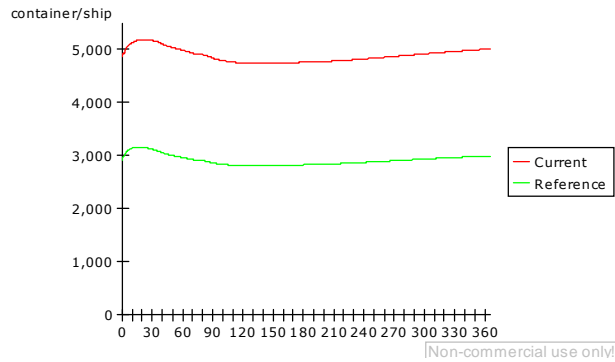
**Figure – 4.75**  
*Number of the Ships in the System*

Each ocean carrier’s capacity is 3,000 containers in the reference scenario; therefore the throughput transported by each ship is 3,000 containers on average. The simulation model is subjected to the sensitivity test and the capacities of ocean carriers’ are reduced to 1,000 containers. As showed on **Figure – 4.74** the model is sensitive to this modification and the throughput per each ship reduces to 1,000 containers on average.

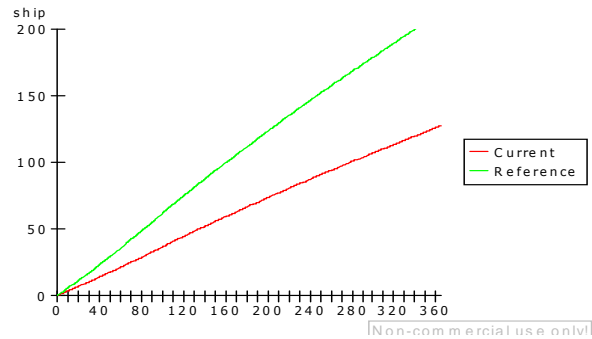
The ship capacity declines, the number of ships increases. The same amount of freight can be carried by more ships having less carrying capacity. **Figure – 4.75** depicts the increase in the number of ships due to the capacity decline. The increase is rational to the amount of the decline in the capacity. The model is subjected to the sensitivity by decreasing the average ship capacity to the 1/3 level; i.e. the ship capacity is reduced from 3,000 containers to 1,000 containers. The capacity declined to 1/3 of the capacity of the reference scenario, the number of ships is expected to increase 3 times. The cumulated number of ships sailed annually is 213 ships in the reference scenario. **Figure – 4.75** shows that the model is subjected to the test, the cumulated number of ships increases to 642 ships. These two values are compared, the ratio is exactly 3 and the result is exactly compatible to the expected value.

- **Capacity of Each Ship Reduced to 5,000 containers**

The model is subjected to the sensitivity test by increasing the average capacity of each ocean carrier to 5,000 containers.



**Figure – 4.76**  
**Average Ship Capacity in the System**



**Figure – 4.77**  
**Number of the Ships in the System**

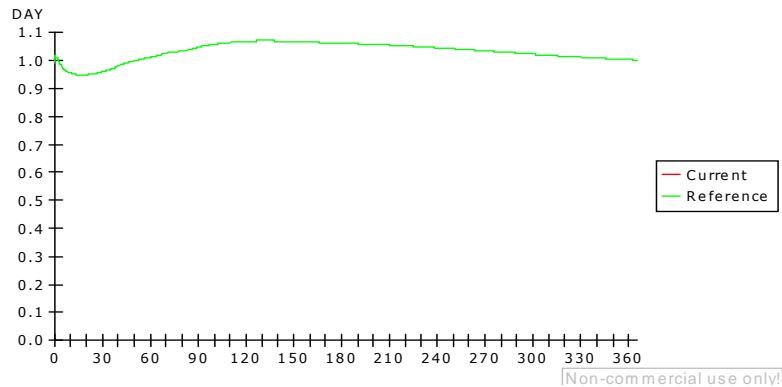
Compared to the reference scenario the average capacity of the ships is increased 60%, the number of ships is expected to decrease 60%; i.e. the number of the ships is expected to decline to 3,000 ships and the average carrying capacity of the ships is expected to increase to 5,000 containers.

The number of the ocean carriers is 213 in the reference scenario and the average throughput per ship is 3,000 containers. The average ship capacity is increased 60%, the number of the ocean carriers expected to decline to 127 ships and the average throughput per ship is expected to increase to 5,000 containers. **Figure – 4.76** depicts that the capacity increased 60%, the average throughput per ship increased to 5,000 containers. **Figure – 4.77** depicts that the ship capacity increased 60%, the number of ships declined 60% and the number of the ships in the reference scenario is 213. The model is subjected to the test of 60% increase in the ship capacity, the number of the ships decline to 127; i.e. the number of the ships in the reference scenario declines 60% and this amount of decrease is exactly compatible to the expected values.

- **Occupancy Ratio of The Harbor**

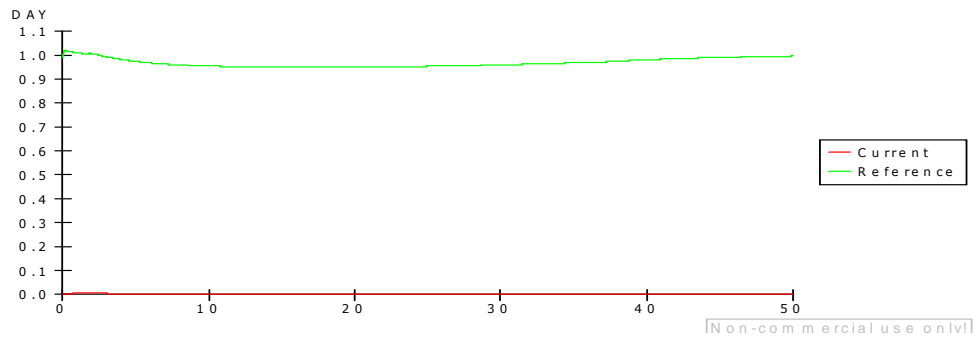
Conjunction in berthing time is excluded from the model. It is assumed that the shipping network is designed flawless. The carrier arrives at the harbor, berths without waiting. Harbors constitute 100% occupancy ratio according to ZERO conjunction in berthing time. The model subjected to a reduction in the average carrying capacity of the ships, the number of the ships is expected to increase but due to the assumption of no conjunction in berthing time, the occupancy ratio is

expected not to change. **Figure – 4.70** shows that the capacity or the number of the ocean carriers increased or decreased the harbor occupancy ratio doesn't change.



**Figure – 4.70**  
**The Occupancy Ratio of Harbor A**  
**Under the Sensitivity Test of the Average Ship Capacity is Reduced to 1,000 Containers**

Subjected to the extreme condition test of ZERO loading/unloading capacity, no berthing, no sailing facilities and no harbor operations are expected. **Figure – 4.71** vindicates there is no berthing or sailing if the loading/unloading capacity declines to ZERO.



**Figure – 4.71**  
**The Occupancy Ratio under the Extreme Condition Test of**  
**ZERO Loading/Unloading Capacity.**

### 4.7.3 Dimensional Consistency

The model is tested according to the dimensional consistency. The software settings are adjusted as unit dependable while building the model; therefore, in a case of a unit inconsistency the software gives caution scripts before running the model. The model doesn't give any monitions. Therefore it is concluded that the model is successful according to the dimensional consistency test.



#### ***4.7.4 Structural Assessment***

The model is subjected to the structural assessment. No stocks and no flows should be in violation of real conditions according to this test; there should be no negative stocks or no negative flows.

The three main stocks are the empty container inventories in the harbors. These inventories are consisted of six arrays, and in the beginning initial stock values are allocated to each array division. To illustrate,

{10000,10000,9791.66666666667,9791.66666666667,10000,9791.66666666667}<<container>>

exhibits the initial values of each array division. *If* function is created while creating an outflow, and the outflow is restricted with the total number of containers in the stock according to that function. The total number of containers in the stock is equal to ZERO or below ZERO the outflow is ZERO. The formulation is done:

***IF(ARRSUM('Empty Container Inventory at A')<=0<<container>>,0<<container/DAY>>***

In some cases it is observed that some array divisions reduce to below ZERO. For instance:

{5000,-1000,3000,10000,9791,10000}<<Container>>

This situation is tested several times and it was observed that there is no inviolation of real conditions. This negative value shows that the 2<sup>nd</sup> array division utilized 1,000 containers from another array division. But total stock level of the empty container inventories doesn't decline below ZERO level.

The model is subjected to the tests, 33 stocks are scrutinized and it is concluded that the model generated the behaviors compatible to the expected values. The sensitivity tests and extreme condition tests approve that the model is realistic; therefore the simulation model can be regarded as "Realistic".



# CHAPTER V

## 5. POLICY DEVELOPMENT

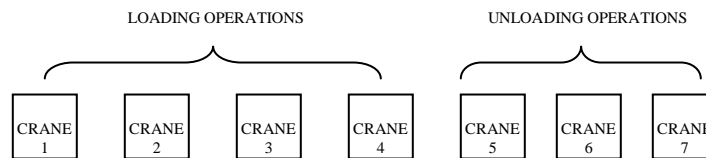
*In Chapter-I* the general characteristics of the container logistics, the main problems and the weak points of the container logistics structure were explained. It was given that the high volume of empty container movements and the high container idle time were the main problems of the container logistics. The ratio of the empty container movements to volume of the total container movements was regarded as “Empty Container Ratio”. The volume of the containers being idle was regarded as “Average Idle Level”. The idle level is evaluated as unproductivity of a container. A container is productive as long as it moves or flows. Two sorts of “Average Idle Levels” are calculated according to two different assumptions: only a container which is full and moving is productive, regardless of being full or empty if a container is moving it is productive. The variable of “Average Idle Level per Full Container” represents the idle container level calculated by the full container movements; and mostly this variable is utilized for the analyses.

*In Chapter-II*, it was given more information about the container logistics in detail and the logistics structure with numerical relations was introduced. *In Chapter-III* a general literature review was done.

*In Chapter-IV* a container logistics structure including the inland transportation and inland facilities were generated. Three harbors named as A, B and C were created. 7 cranes are installed in each harbor and 9 shipping directions were created. **Figure- 5.1** depicts the shipping directions from each harbor and **Figure- 5.2** depicts the crane installation structure in each harbor. Four of the cranes are allocated for loading operations and three of them are allocated for unloading operations. Crane-1 and crane-7 are allocated for empty container operations. Crane-1 and crane-7 are used for full container loading/unloading operations unless there are empty container movements; i.e. the empty container movements reduces the full container loading/unloading capacity by allocating two of the cranes for loading/unloading empty containers. A simulation model consisted of 12 modules replicating the harbor facilities and container flows were generated.

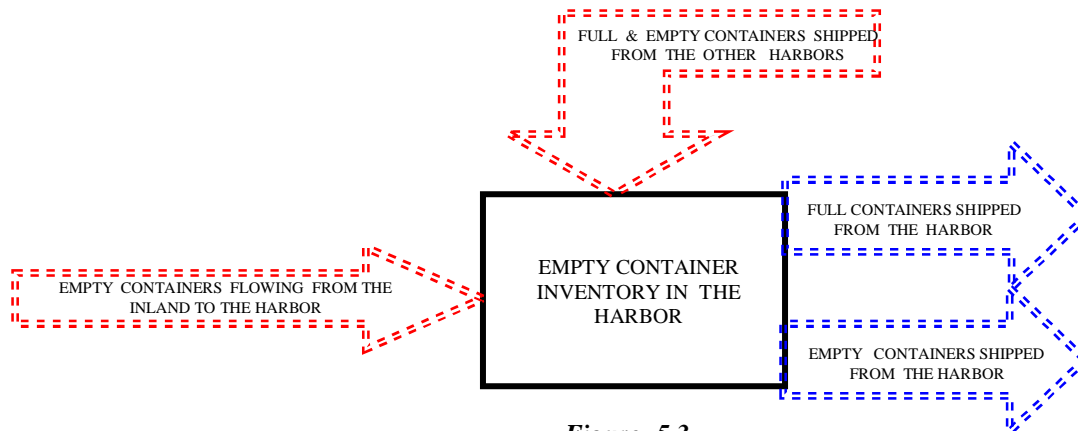
A-B	A-C	A-B-C
B-A	B-C	B-A-C
C-A	C-B	C-B-A

**Figure- 5.1**  
**Shipping Directions**



**Figure- 5.2**  
**Crane Installation Structure in the Harbor**

A harbor receives empty containers from the inland. The demand for transportation and for shipping is received in tonnage and this volume is converted into the number of containers according to the dimensional and carrying capacity of a container. The demand is received and the planning facilities are done, the containers are stuffed to be shipped. It is assumed that stuffing operations are done only in the harbors. Full and the empty containers shipped from the harbor and, full and empty containers are being received from the other harbors. The full containers shipped from the other harbors are directly sent to the inland warehouses when they arrive at the destination harbor. Delivery to the customers in the harbor site is neglected and deliveries to the customers are done only in the inland. Therefore the full containers arrived at the harbor cannot be utilized unless they are transported to the inland, delivered to the customers and sent back to the harbors from the inland. Thus; no full containers are kept in the harbors and therefore the container inventory in the harbors are regarded as “Empty Container Inventory”. **Figure- 5.3** depicts the inflows and outflows in the harbor. The empty containers arrived from the other harbors are added directly to the empty container inventory in the harbor and they are ready to be utilized when they arrive.



**Figure- 5.3**  
**Inflows and Outflows in the Harbor**

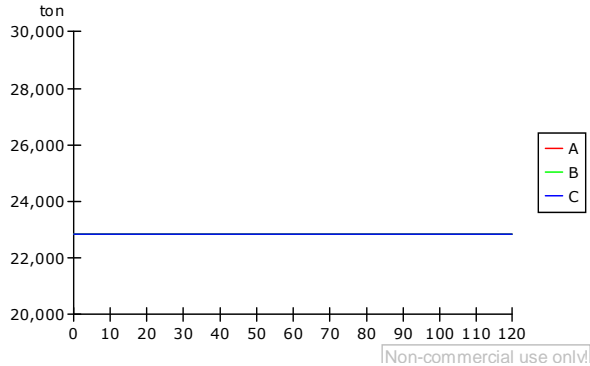
*Each harbor calculates all the expected empty container flows from inland. Each harbor sends empty container demand to the other harbors if the expected volume of the empty containers from inland is not enough to keep the empty container inventory at the desired level. The empty container demand is generated by the discrepancy between the number of containers arrived and the number of containers shipped from the harbor. It is emphasized that the discrepancy between the inflow and outflow of the empty containers in the harbor is the origin of the empty container flows.*

First of all, the model is put into equilibrium. Secondly, the current scenario is created and analyzed in this chapter. The system in equilibrium creates no empty container flows. That's the most desired, yet utopian situation. The most desired situation is generated with a stable demand for shipping. There are three shipping directions in each harbor. It is assumed that the demand for shipping is 22,860 ton/day in each harbor. The number of containers required for the shipping is calculated according to the stowage factor of the material to be transported, and according to the carrying and dimensional capacity of a container. *(See Chapter 4, MODULE-1)* 22,860 ton/day demand for shipping requires 750 container shipments per day in each harbor. The number of the containers required for the shipment is regarded as "The Demand for the Containers", i.e. the demand for the containers is the transportation demand converted into the number of containers. In equilibrium, the total demand for shipment is 68,580 ton/day in three harbors.

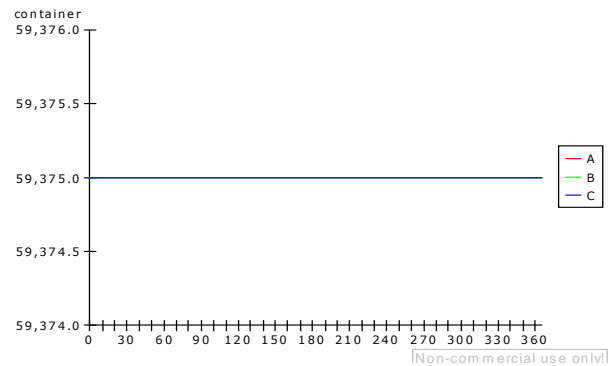
### **5.1 Equilibrium**

The demand is stable in each harbor in equilibrium. It is supposed that each harbor receives demand for freight transportation to three different directions. *(See Chapter-4, 4.4.6 Container Transportation Routes between the Harbors)*. The total demand for freight transportation each harbor receives is 22,860 ton per day. The demand for the freight to transport is converted into the number of containers in the planning phase. In harbor A, 750 containers per day are required

for shipping the freight to A-C direction. 500 containers per day are required for shipping the freight to A-B direction and 250 containers are required for A-C direction every day. In harbor B, 250 containers per day are required for each shipping direction of B-A, B-C and B-A-C. In harbor C, 250 containers per day are required for each shipping direction of C-A, C-B and C-B-A. **Figure – 5.4** and **Figure – 5.5** show each empty container level in harbor A, B and C in equilibrium.

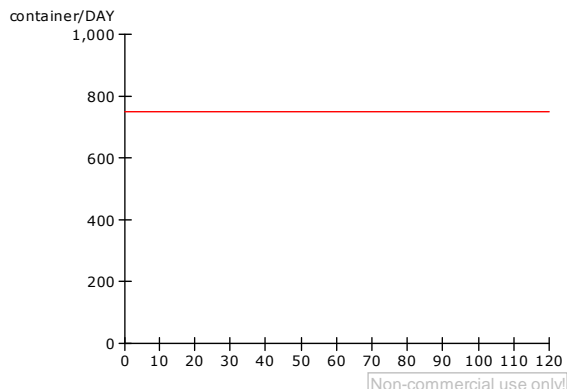


**Figure – 5.4**  
**Received Demand for Transportation in Tonnage in Harbor A, B and C in Equilibrium**

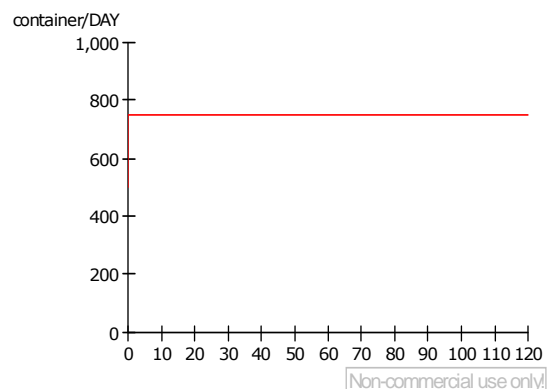


**Figure – 5.5**  
**Empty Container Inventory Level in Harbor A, B and C in Equilibrium**

It was explained that the discrepancy between the volume of the empty containers the harbor receive from the inland and the volume of the containers shipped from the harbor is the most important factor generating the empty container movements. In the equilibrium there is no empty container shipment and the volume of the containers shipped from the harbor is equal to the volume of the containers arriving at the harbor from the warehouses.



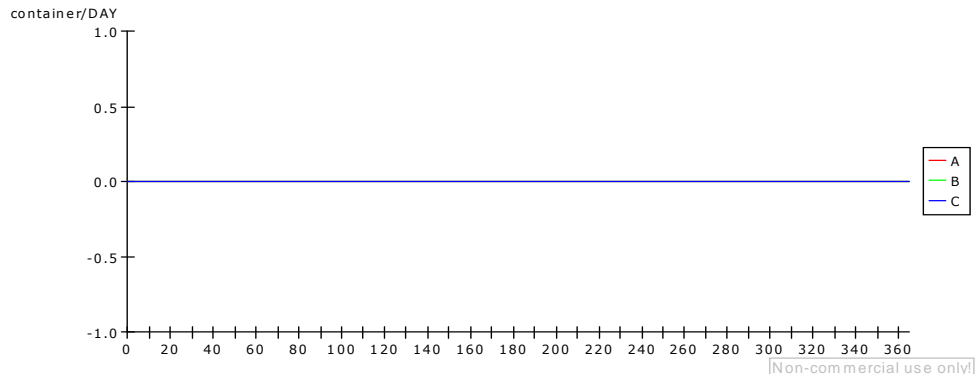
**Figure – 5.6**  
**Inland flows at A in Equilibrium**



**Figure – 5.7**  
**Full Container Flows Shipped from Harbor A in Equilibrium State**

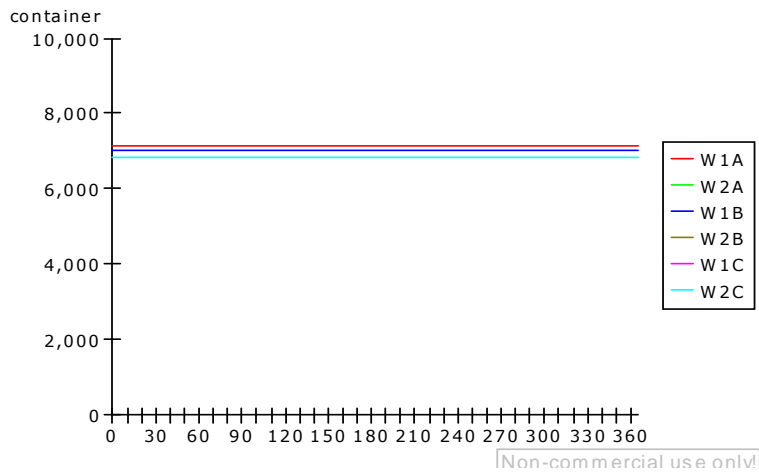
**Figure – 5.6** and **Figure – 5.7** represent that the volume of the containers shipped and the volume of the containers arrived at the harbor are equal. There is no discrepancy between the

inflow and the outflow of the container inventory in harbor A, harbor B and harbor C. Thus, no empty containers flow between the harbors.



**Figure – 5.8**  
**Empty Container Flows in Equilibrium**

**Figure – 5.8** shows that there is no empty container flow in the equilibrium. The empty container volume sent by each harbor is ZERO in the graph.



**Figure – 5.9**  
**The Level of the Empty Container Inventories of the Warehouses at A, B and C in Equilibrium**

**Figure – 5.9** depicts that all the stocks of the inland warehouses are in equilibrium. The inflow and the outflow are equal.

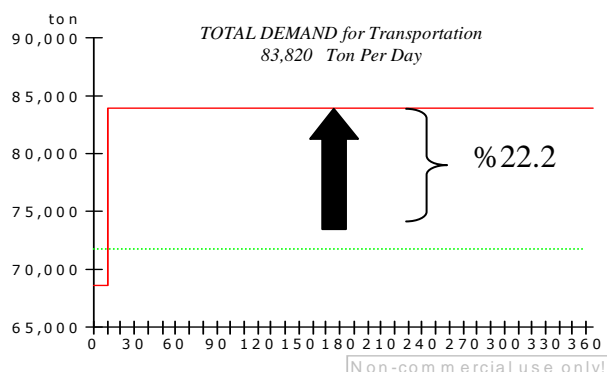
## 5.2 The Reference Scenario

The reference scenario is generated by increasing the demand. The increase is applied by two means:

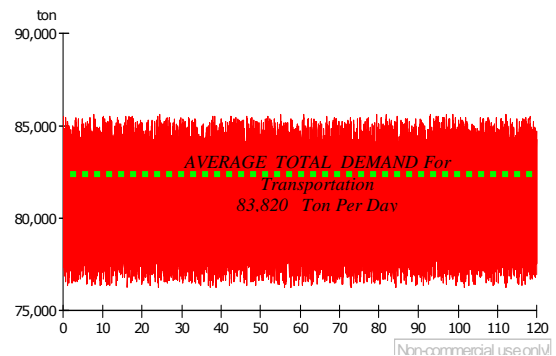
- Increase with a **Step** function: the demand is increased 22.2% with a step function. The total demand in the three harbors is 68,580 ton/day in the equilibrium. The demand for freight transportation is increased to 83,820 ton/day with a step function. **Figure – 5.10** represents the 22.2% step increase in the total demand for transportation.
- Increase with a **Random** function: the demand fluctuating with a 10% standard deviation is increased averagely 22.2 % with a random function; i.e. a noise is generated in the total demand. **Figure – 5.11** represents that the demand for freight transportation that increased 22.2% and fluctuating with a 10% standard deviation. The green line on **Figure – 5.11** shows the average increase with the demand.

In the equilibrium, the system is not utilizing its full capacity. With a 22.2% increase the system commence to utilize 100% of its capacity. While no container is sent to A-B-C direction in the equilibrium, in the reference scenario all the shipping networks and shipping directions are being utilized.

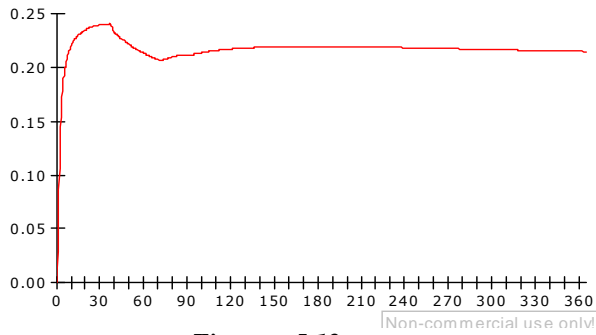
In equilibrium, the demand for freight transportation to A-B route requires 500 container shipments per day; to A-C direction the demand requires 250 container shipments per day and to A-B-C direction 250 container shipments are required per day. In harbor B, 250 containers/day are required for each direction of B-A, B-A-C and B-A. In harbor C, 250 containers/day are required for each shipping direction of C-A, C-B and C-B-A.



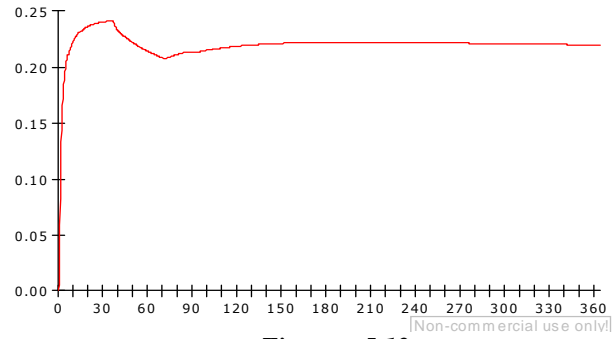
**Figure – 5.10**  
**10% Step Increase in the Total Demand**  
**for Transportation**



**Figure – 5.11**  
**Noise in the Total Demand**  
**(Demand is Increased 10% and is Fluctuating with a**  
**10% Standard Deviation)**



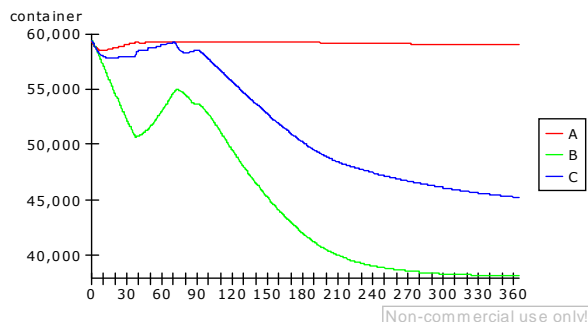
**Figure – 5.12**  
*The Empty Container Ratio with a 10% Step Increase in the Total Demand*



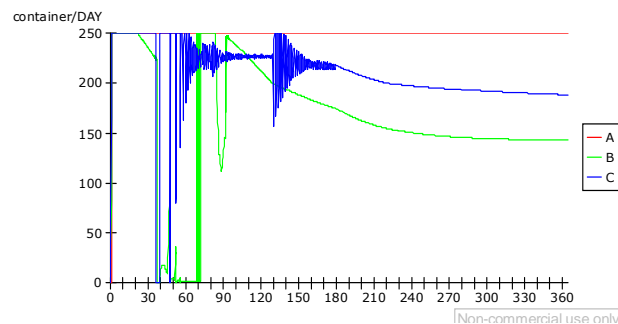
**Figure – 5.13**  
*Empty Container Ratio in Reference Scenario with a Noise Application on the Demand*

In reference scenario, the reference demand for freight transportation to A-B route requires 550 container/day, to A-C direction the reference demand requires 275 container/day and to A-B-C direction the reference demand for freight transportation requires 275 container/day. In harbor B, 275 containers/day are required for each direction of B-A, B-A-C and B-A. In harbor C, 275 containers/day are required for each shipping direction of C-A, C-B and C-B-A in reference scenario.

The outcomes of these two applications on the demand are showed on **Figure – 5.12** and **Figure – 5.13**. 22.2% step increase and a noise in the demand generate almost the same behavior in empty container flows. However, a demand fluctuating is more realistic and more compatible to the realistic situation. Therefore, a noise with a 22.2% average increase in the demand *is* used to generate the reference scenario. But, the 22.2% increase with step function is also used while analyzing the behavior of the model. **Figure – 5.13** shows the average empty container ratio in the reference scenario. While there is no empty flow in the equilibrium, the ratio of the empty container volume to the total number of containers flowing is around 20% in the reference scenario.



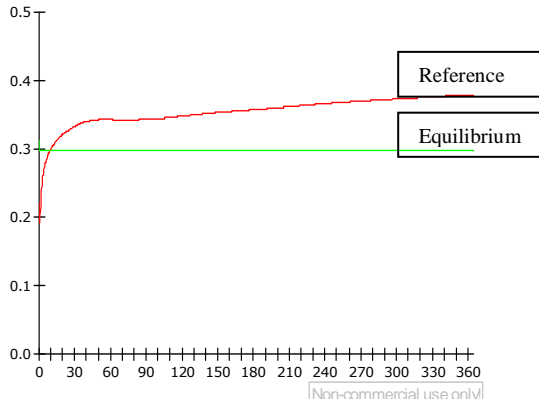
**Figure – 5.14**  
*Container Inventory Levels of Each Harbor in the Reference Scenario*



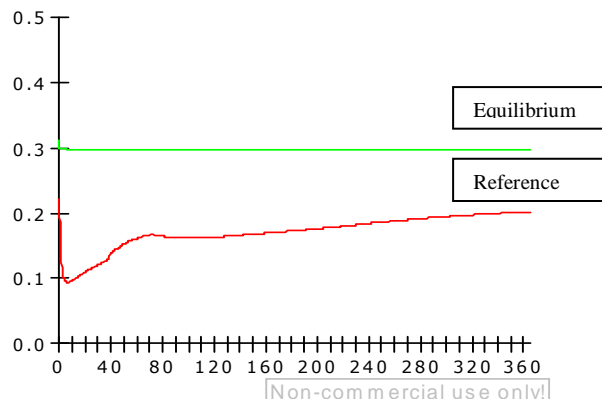
**Figure – 5.15**  
*Average Empty Container Ratio in the Reference Scenario*



**Figure – 5.14** depicts each empty container level of harbor A, B and C and the graph demonstrates that harbor B is the most vulnerable one to the vicissitudes in the demand in the reference scenario. Harbor A establishes a robust characteristic when the harbor is subjected to an increased demand.



**Figure – 5.16**  
*Average Idle Level of Containers in the Reference Scenario (Calculated According to the Full Container Movements)*



**Figure – 5.17**  
*Average Idle Level of Containers in the Reference Scenario (Calculated According to Both Empty and Full Container Movements)*

**Figure – 5.16 and Figure – 5.17** demonstrate the average idle level (unproductivity level) of a container. The idle container level is around 29% in the equilibrium. The full containers moving are assumed as productive, the average idle (unproductivity) level increases to 37% in the reference scenario. In the equilibrium there is no empty container flow. With the increased demand and increased discrepancy between the inflow and outflow in the harbor, empty containers begin to flow in the reference scenario. In the equilibrium, the cranes allocated for the empty equipment loading/unloading operations are allocated to assist in the other full container loading/unloading operations as well. Therefore the full container loading/unloading capacity is high during there are no empty container flows, and more full containers are loaded/unloaded when there are no empty container flows. On the other hand, the volume of the empty equipment flows increased, the cranes allocated for assisting in the full container loading/unloading operations stop assisting in the full container loading/unloading operations and commence to load/unload empty equipment. Therefore the volume of the full containers loaded/unloaded declines. The full container movements are accepted as productive, the productivity declines with the increasing volume of empty containers and the declined volume of full container movements. **Figure – 5.16** depicts the decline in average container productivity (Increase in idle container level) generated by the increased empty movements.

Regardless of being full or empty all the containers moving are assumed as productive, i.e. if all the containers flowing full or empty are assumed as productive, the productivity increases (Idle container level of a container decreases) with the increased number of empty container movements in the reference scenario. *Figure – 5.17* depicts the declined idle container level. The volume of empty container movement increases in the reference scenario. Although the full container movements declined, the increase in the empty container movement is almost 20% (*Figure – 5.13*). The unproductivity declines from 29% to 20% because of the increase in the empty container movements. The assumption of “Empty or full, if a container is moving it is productive” justifies this increase. (*See Figure – 5.17* )

### ***5.3 Analyzing the Empty Container Inventories in the Reference Scenario***

Three empty container inventories of harbor A, harbor B and harbor C are analyzed. Variable of “Gap” represents the discrepancy between the volume of the containers shipped to the other harbors and the volume of the containers flowing from the inland to the harbors.

$$\begin{array}{c}
 \text{Inflow} \\
 \underbrace{\hspace{15em}} \\
 \text{Gap} = (\text{Volume of the Containers Flowing From the Inland} + \text{Volume of the Empty Containers the Harbor Receiving From the Other Harbors}) \\
 - (\text{Volume of the Full Containers Shipped From the Harbor} + \text{Volume of the Empty Containers Shipped from the Harbor}) \\
 \underbrace{\hspace{15em}} \\
 \text{Outflow}
 \end{array}$$

*Figure – 5.18 Discrepancy between the Inflow and Outflow*

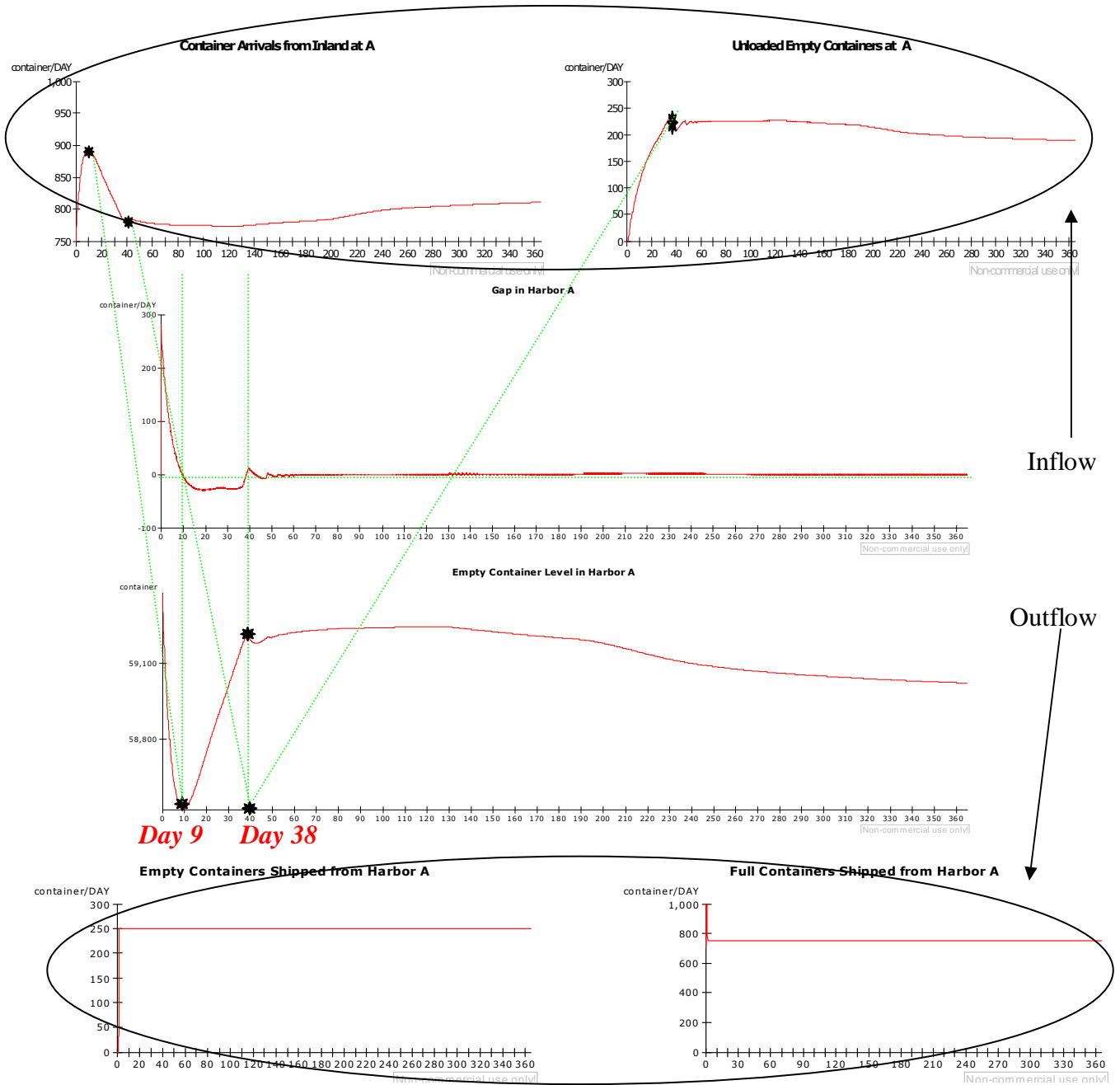
First of all, the graphs representing the inventory level, the gap, and the graphs demonstrating all the inflows and outflows in each harbor are put together. Secondly, the graphs representing the empty and full container shipments from each harbor to each shipment direction are put together. The empty container level in each harbor is analyzed by utilizing all these graphs. Moreover, empty container inventory of harbor B is analyzed by two means: a random increase is applied to the demand and a step increase is applied to the demand.

The variable of average gap is calculated by dividing the cumulated volume of the gap by the *TIME*. The average gap between the container inflows and container outflows gives a general aspect in evaluating the level of the inventories.

### 5.3.1 Inventory A

The inventory level in harbor A is analyzed in three phases:

- ❑ Day 0 - Day 9
- ❑ Day 0 - Day 38
- ❑ After day 38



**Figure – 5.19**  
*Outcomes of the Discrepancy between the Received and Shipped Container Volume and the Empty Container Inventory at A*

### *Day ZERO – Day 9*

In equilibrium, the transportation demand for A-C direction requires 500 containers/day, for A-B direction 250 containers/day and for A-B-C direction 0 containers/day. In the reference scenario the number of the containers required for the A-C direction is 550 per day, for A-B direction 275 containers/day and for A-B-C direction the number of the containers required is 275 per day. The increase in the demand on day ZERO generates the reference scenario. The demand increased on day ZERO with the random function.

On day 1 the gap increases around 290 containers. Then the gap declines. *Figure – 5.19* shows that between day ZERO and day 9 the gap between the inflow and outflow is positive; i.e. the outflow is larger than the inflow; therefore the inventory of empty containers in harbor A declines between day ZERO and day 9.

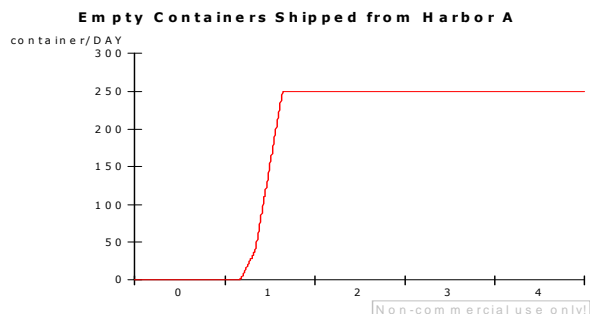
The desired empty container inventory level in each harbor is 60,000 containers. Each harbor is sending empty container demand for empty containers transportation from the inland to keep the inventory in the desired level. The increase in the demand means more container shipments from the harbor and more container transportation from the inland to the harbor to keep the empty container inventory in the desired level. The increase in the demand reduces the empty container inventory and the empty container inventory declines to its nadir on day 9.

The graph "Container "Arrivals from Inland" (*See Figure – 5.19*) demonstrates the containers transported from the inland. Due to the increased container demand, Harbor A increases the volume of the demand for empty container transportation from the inland. During day ZERO and day 9, the volume of the containers transported from the inland increased by the increased demand.

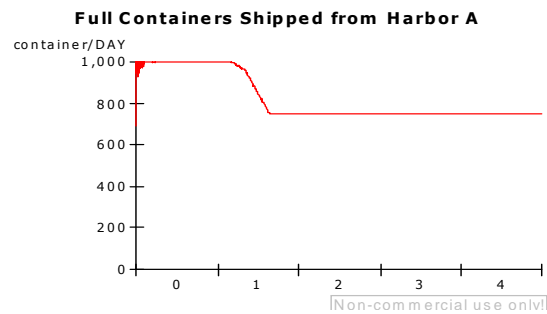
The volume of the empty containers shipped from the harbor (*See Figure – 5.19*) is ZERO on day ZERO. The increased demand increases the volume of the empty container shipments to 250 container/day level with a 1 day delay. After day 1 the empty shipments are stable.

On day ZERO the full containers shipped from the harbor is 1,000 and it declines to 750 container shipments/day on day 1. The full container shipments are stable after day 1. (*Figure – 5.19*). There is a 1 day delay in the empty and full container shipments; but it is difficult to recognize the delay on *Figure – 5.19*; therefore the full and empty shipments are demonstrated on a *Figure – 5.20* and *Figure – 5.21* in a 5 day time horizon. *Figure – 5.20* and

**Figure – 5.21** show that the demand increases on day ZERO, the empty and full containers are shipped 1 day later; i.e. the harbor reacts with a 1 day delay to the alteration in the demand. The delay is the outcome of the empty and full container shipment planning time. The harbor received the demand for the full and empty containers shipments, a pre-shipment planning facility is done. It is assumed that the planning facility takes one day. This phase is simulated with a one day 7 order material delay. Each pre-shipment planning in each harbor has the same characteristics and creates the same delay.



**Figure – 5.20**  
*Empty Containers Shipped from Harbor A*



**Figure – 5.21**  
*Full Containers Shipped from Harbor A*

### **Day 9 – Day 38**

Between day 9 and day 38 the gap is below ZERO; the outflow is smaller than the inflow; i.e. the volume of the containers arriving at harbor A is larger than the volume of the containers shipped empty or full from the harbor. Therefore, the negative gap causes an increase in the empty container inventory of harbor A. On day 38, the gap is equal to ZERO the empty container inventory increases between day 9 and day 38. On day 38 the inventory level reaches a peak.

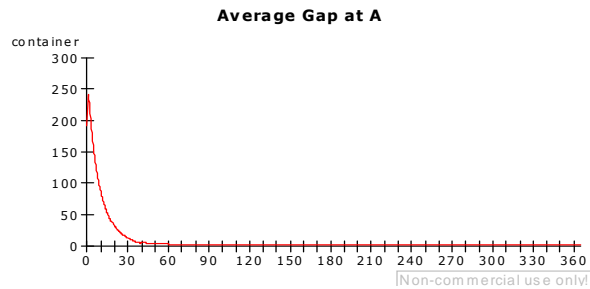
The harbor receives empty containers from the other harbors. The graph of “Unloaded Empty Containers” demonstrates these empty container arrivals. Between day 9 and day 38 the volume of the empty container arrivals is increasing. The empty container arrivals reach a peak on day 38. On day 38, the empty container inventory reaches a peak after the sudden decline on day ZERO. It is concluded that the peak of the empty container inventory is caused by the peak of the empty container arrivals on day 38.

Empty and full container shipments are stable between day 9 and day 38.

### **After Day 38**

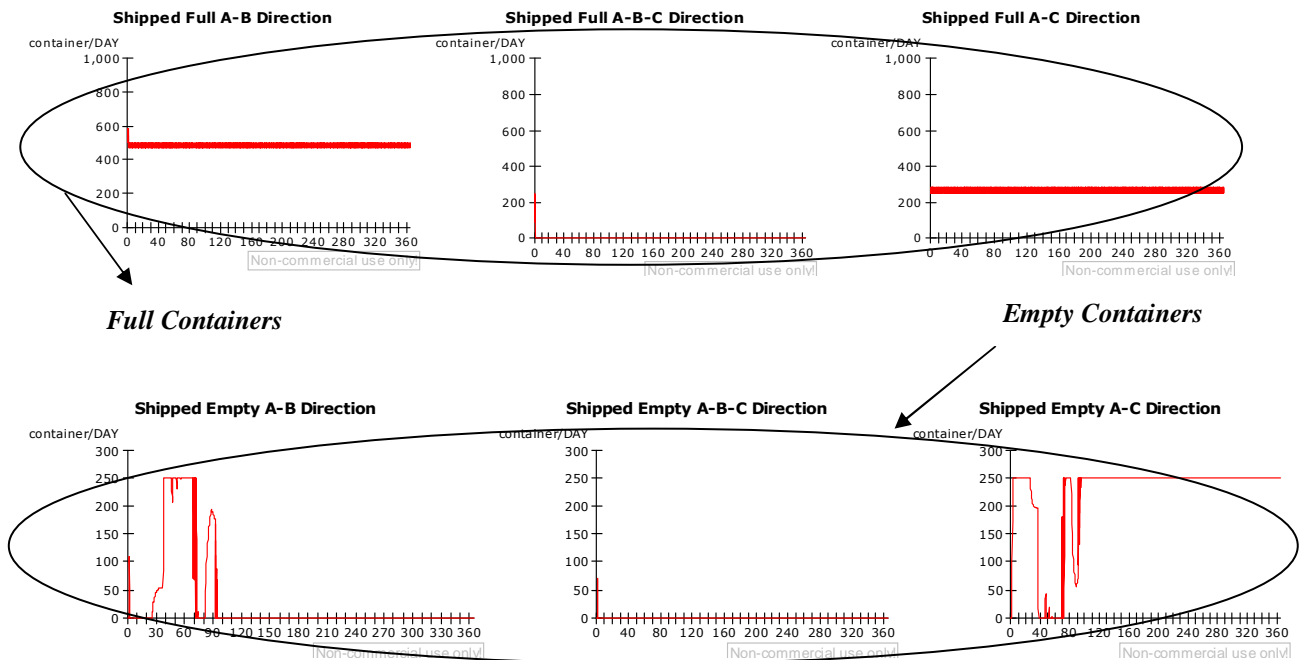
The gap increases over ZERO after day 38 and reaches its peak on day 40 after the sudden increase on day ZERO. The gap is around ZERO between day 38 and day 210. Therefore the empty container inventory level is roughly stable between day 38 and day 210. The gap increases

above ZERO on day 210 with small fluctuations. Therefore the empty container inventory declines slowly after day 210.



**Figure – 5.22**  
**Average Gap at A**

*Figure – 5.22* shows the average gap at A. The average gap gives a general aspect about the empty container inventory level at A. In general, the gap at A is around ZERO. Therefore, the empty container inventory at A doesn't fluctuate with oscillations.



**Figure – 5.23**  
**Volume of the Empty and Full Containers Shipped From Harbor A**

*Figure – 5.23* shows the volume of the empty and full container shipments from harbor A. Each shipment is classified according to the shipment directions from A. It is assumed that each harbor supports another harbor by prioritizing one of its shipment directions. Among the three harbors of A, B and C, harbor C is the one which has the most priority in harbor A. Therefore the shipment direction of A-C has the 1<sup>st</sup> priority in harbor A and the shipment direction of B-C has

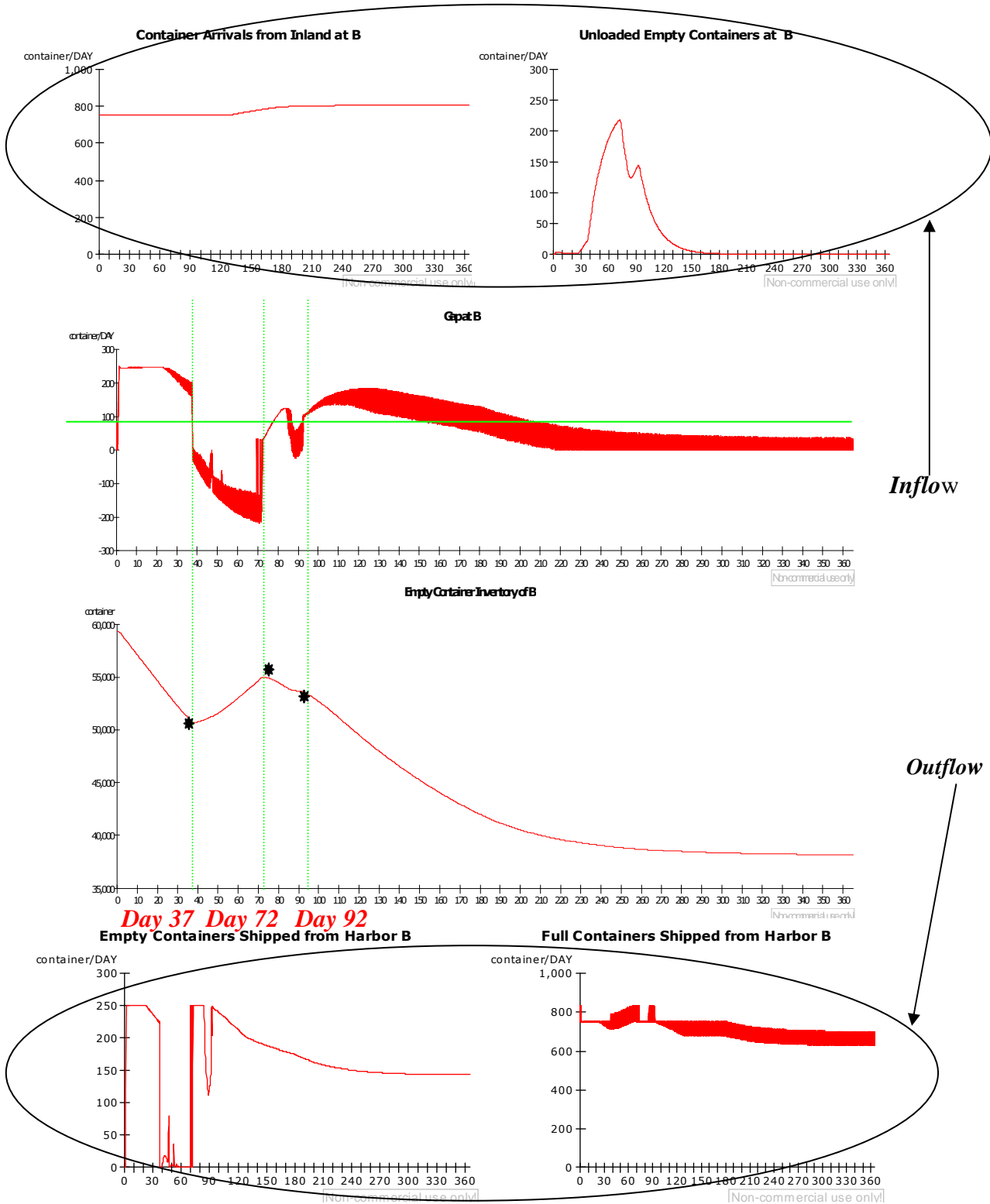
the 1<sup>st</sup> priority in harbor B. The container shipment directions from harbor A are: A-C, A-B and A-B-C. *Figure – 5.23* demonstrates that full containers are shipped from harbor A to A-C and A-B directions constantly. There is no full container shipment to A-B-C direction. The demand for the freight to transport to A-C direction requires 500 containers/day, to A-B direction the demand requires 250 containers/day and to A-B-C direction the demand requires 0 containers/day in the equilibrium. In the reference scenario the demand increases and the reference demand requires 550 containers/day for A-C direction, 275 containers/day for A-B direction and 275 containers/day for A-B-C direction. Totally the demand requires 1,100 containers for the full container shipments. On the other hand, the demand for empty containers is around 250 containers/day in the reference scenario. The total loading capacity is 1,000 containers per day (*See Chapter 4, 4.4.4 Loading Structure of the Harbors*); whereas the transportation demand requires 1,350 loading operations and 1,350 containers per day. Therefore, some demands for the transportation is rejected during the planning schedule. This rejection is done according to the priorities of the shipment directions. Shipment direction of A-B-C has the 3<sup>rd</sup> priority in harbor A; thus the demand for the freight to transport to the direction of A-B-C is rejected during the pre-planning phase. *Figure – 5.23* shows that there is no full container shipment to the direction of A-B-C due to the lack of loading capacity.

Between day 30 and day 70, empty containers are shipped to A-B direction instead of A-C direction although A-C direction has the 1<sup>st</sup> priority. It is concluded that those shipments are related to the empty container level of harbor C. *Figure – 5.28* shows that the empty container level of harbor C is almost at its desired level. On the other hand, *Figure – 5.24* depicts that the empty container inventory of harbor B declined more than 10% between day 30 and day 70. Therefore, harbor A sends empty containers to harbor B instead of harbor C between day 30 and day 70. After day 70, harbor A stops to ship empty containers to harbor B and it commences to ship empty containers to harbor C.

### **5.3.2 Inventory B**

Inventory B is analyzed in for phases:

- ❑ **Day ZERO – Day 37**
- ❑ **Day 37 – Day 72**
- ❑ **Day 72 – Day 92**
- ❑ **After Day 92**



**Figure – 5.24**  
**Outcomes of the Discrepancy between the Received and Shipped Container**  
**Volume and the Empty Container Inventory at A**  
**(Discrepancy is Generated with a Noise in the Demand)**



**Figure – 5.24** depicts all the inflows, outflows, the discrepancy between the inflow and outflow and the level of the empty container inventory of B.

#### **Day ZERO – Day 37**

On day ZERO the gap is ZERO. In the reference scenario the demand increases on day ZERO and the gap increases on day 1. This delay was explained previously as an outcome of pre-shipment planning time. (*See Figure – 5.20 and 5.21*) Between day ZERO and day 37, the gap is above ZERO; i.e. the outflow is larger than the inflow; therefore the empty container inventory of Harbor B is declining between day 1 and day 37. On day 37 the gap is equal to ZERO. The decline in the empty container inventory commences on day 1 due to the pre-shipment planning and on day 37 the empty container inventory reaches its nadir level.

The number of the container arrivals from inland B is 250 container/day between day ZERO and day 37. On day 37 the arrivals from inland B declines to ZERO. This situation is related to the empty container level of harbor C. Harbor C has the first priority among the shipment directions in harbor B. B-C shipment direction has the first priority. **Figure – 5.28** shows the empty container level of harbor C. The empty container level of harbor C between day 37 and day 72 is almost at its desired level; therefore harbor B stops sending empty equipment to harbor C between day 37 and day 70. Full containers shipped from harbor B is 750 containers/day between day ZERO and day 37.

Empty container arrivals from inland B is 750 containers/day between day ZERO and day 37. Unloaded empty containers in harbor B is roughly ZERO between day ZERO and day 37 and the volume of the unloaded empty containers increases on day 37.

#### **Day 37 – Day 72**

The gap at B is below ZERO between day 37 and day 72. The gap declines below ZERO on day 37 and then on day 72 the gap is equal to ZERO again. The gap is negative between day 37 and day 72; i.e. the inflow is larger than the outflow; therefore the empty container inventory increases between day 37 and day 72. On day 72, the empty container inventory of harbor B reaches the peak. Between day 37 and day 72 the volume of the empty container shipments is ZERO. ZERO empty container shipment is related to the high level of empty container inventory in harbor C. The volume of the full container shipments is increasing between day 37 and day 72. This situation is related to the loading capacity. Empty Container level in harbor C reaches its

desired level between day 37 and day 72; therefore there is no empty container shipment to harbor C between these days. Due to ZERO demand for empty containers, no empty equipment loading operations are done between day 37 and day 72. Thus; loading capacity is utilized for full container shipments; i.e. more demand for transportation is accepted, more full containers are required and more full containers are loaded between day 37 and day 72. (*See Figure – 5.24, Graph of Full Containers Shipped from Harbor B*). On day 72, the volume of the full containers shipped declines to 750 container shipments per day.

The volume of the unloaded empty containers in harbor B increases on day 37 and it reaches its peak on day 72. Empty containers unloaded in harbor B is one of the main inflows in harbor B; therefore the peak in the volume of the unloaded empty containers causes an increase and a peak in the empty container inventory level in harbor B on day 72.

#### ***Day 72 – Day 92***

Between day 72 and day 92, the gap is above ZERO; i.e. the outflow is larger than the inflow in harbor B between day 72 and day 92. Therefore the empty container level declines between day 72 and day 92.

The volume of the empty container arrivals is stable and is around 750 per day between day 72 and day 92. The volume of the empty containers unloaded in harbor B declines between day 72 and day 92. It is concluded that this decline causes the decline in the level of empty container inventory in harbor B between day 72 and day 92.

The volume of the empty container shipments increases to 250 per day between day 72 and day 80, and on day 80 the volume declines to 120 container shipments from 250 shipments per day. The decline in the volume of the empty container shipments between day 80 and day 92 causes an increase in the full container shipments in harbor B between day 80 and day 92. The volume of the empty containers shipped declined; the loading capacity is allocated for more full container loading operations. Therefore more full containers are shipped from harbor B between day 72 and day 92.

#### ***After Day 92***

The gap in harbor B is over ZERO between day 92 and day 250; i.e. the outflow is larger than the inflow; therefore the empty container inventory in harbor B declines between day 92 and day 250. The gap declines decreasingly. After day 250, the gap is fluctuating around ZERO and is

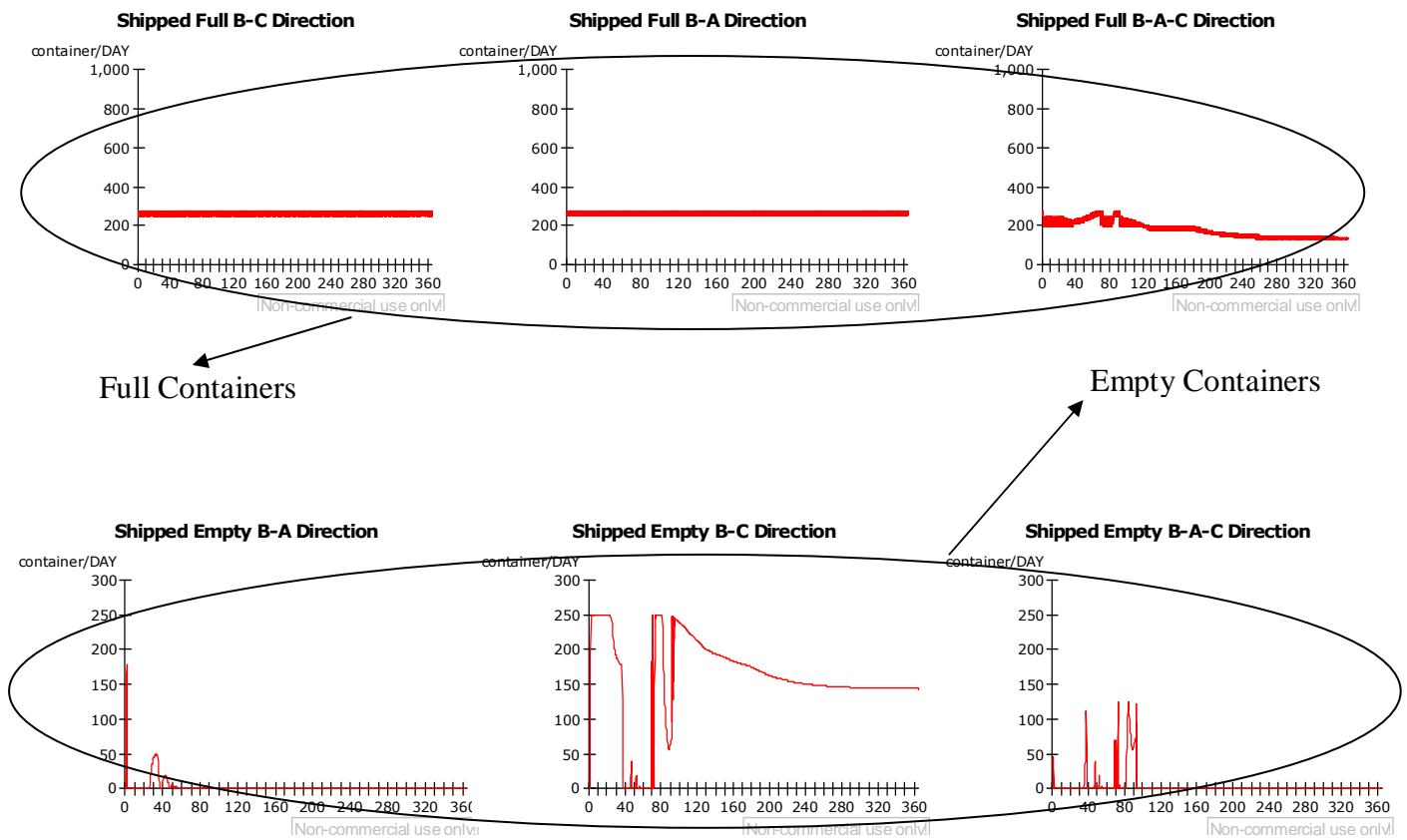
close to ZERO. Thus; empty container inventory in harbor B reaches a new equilibrium point after day 250.

The volume of the empty containers shipped from harbor B increases between day 87 and day 95. Between day 87 and day 95 the volume of the empty containers shipped from harbor B is below 250 shipments per day; therefore the volume of the empty container shipments below 250 is utilized by full container loading capacity. It is concluded that the empty container loading capacity is utilized by full container loading capacity between day 87 and day 95; therefore between these days more full containers are shipped and loaded and this situation is depicted on **Figure – 5.24** on the graph of “Full Containers Shipped from Harbor B” between day 87 and day 95.

The volume of the empty container arrivals is stable between day 92 and day 135. On day 135, the volume increases from 750 to 800 container transportation from the inland per day; i.e. containers transported from the inland are increased on day 135. This situation is related to the empty container level of harbor B. On chapter 4 (*See Chapter 4, page 121 and Figure - 4.71*) it was explained that the container inventory declined to critical level, the inland warehouses commence to prefer faster transportation modes to supply the empty container inventory in harbor. **Figure - 4.71** shows that the empty container inventory declines below 80%, the “Effect of Container Demand on Inland Transportation Rate” appears. It means that the effect reduces the volume of the containers sent by barge which requires 10 days journey; and the reduced volume is added to a faster transportation mode. Therefore more containers are arriving and the system is utilizing more transportation capacity. On day 135, the empty container level declines to 47,250 container level. This level is almost 20% below of the desired container inventory level and defined as a critical level; therefore **MODULE-12** (*See Chapter 4, page 121 and Figure - 4.71*) commences to effect the inland transportation.

Volume of the unloaded empty containers declines after day 92 and on day 165 the volume is equal to ZERO. This situation is related to the volume of the empty container arrivals from inland B. Due to the critical empty container inventory level in harbor B the empty container transportation volume increased (*See Chapter 4, page 121 and Figure - 4.71*) and that increase is concluded as to be enough to reduce the discrepancy between the outflow and inflow. **Figure – 5.24** shows that the gap commence to decline slightly on day 135; therefore harbor B is not sending demand for empty containers to be shipped from the other harbors. The harbor is

supplied by the inland after the day 165 and the volume of the unloaded empty containers in harbor B is ZERO on the same day.



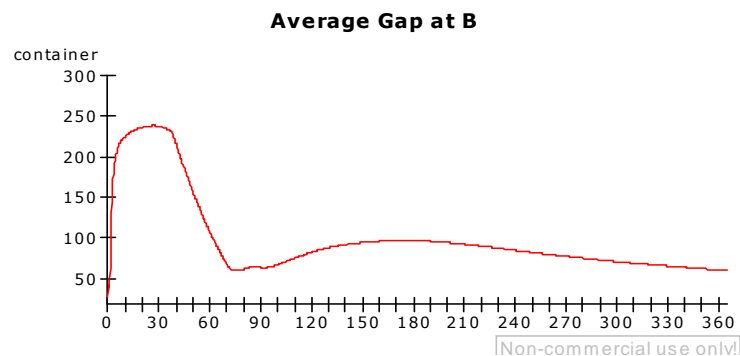
**Figure – 5.25**  
**Volume of the Empty and Full Containers Shipped From Harbor B**

**Figure – 5.25** shows that harbor B is shipping full containers to B-C, B-A and B-A-C directions. The situation is different from the situation in harbor A. Although there are three shipping directions in harbor A, due to the high volume of demand for transportation from A, some of the transportation demands were rejected during the pre-shipment planning phase. The rejections are done according to the priority of the shipment directions. Shipment direction of A-C has the 1<sup>st</sup> priority in harbor A, and the demand for transportation from harbor A to A-C direction is very high. The demand for transportation from harbor A to A-B-C direction is turned down because of A-B-C direction having the 3<sup>rd</sup> priority.

In harbor B, the volume of the demand for transportation to B-A, B-C and B-A-C directions is equal. Therefore the volume of the demand rejected is small. **Figure – 5.25** shows that the full containers shipped from harbor B to B-C and B-A direction is roughly 250 containers/day; whereas the volume of the full container shipments is around 200 per day for B-A-C direction.

This situation demonstrates that the harbor rejected some transportation demands to B-A-C direction due to lack of loading/unloading capacity; i.e. some demands for transportation to B-A-C direction were rejected because the shipment direction of B-A-C having the 3<sup>rd</sup> priority.

**Figure – 5.25** shows that harbor B is supplying harbor C with empty containers. The graph “Shipped Empty B-A Direction” depicts that harbor B shipped empty containers to harbor A between day 30 and day 40. This situation is related to the empty container level of harbor C. **Figure – 5.28** shows that between day 30 and day 40 empty container level of harbor C is almost at its desired level; therefore the empty containers are shipped to harbor A. After day 72, the empty container level of C declines (**Figure – 5.28**) therefore harbor B commence to ship empty containers to harbor C after day 72.

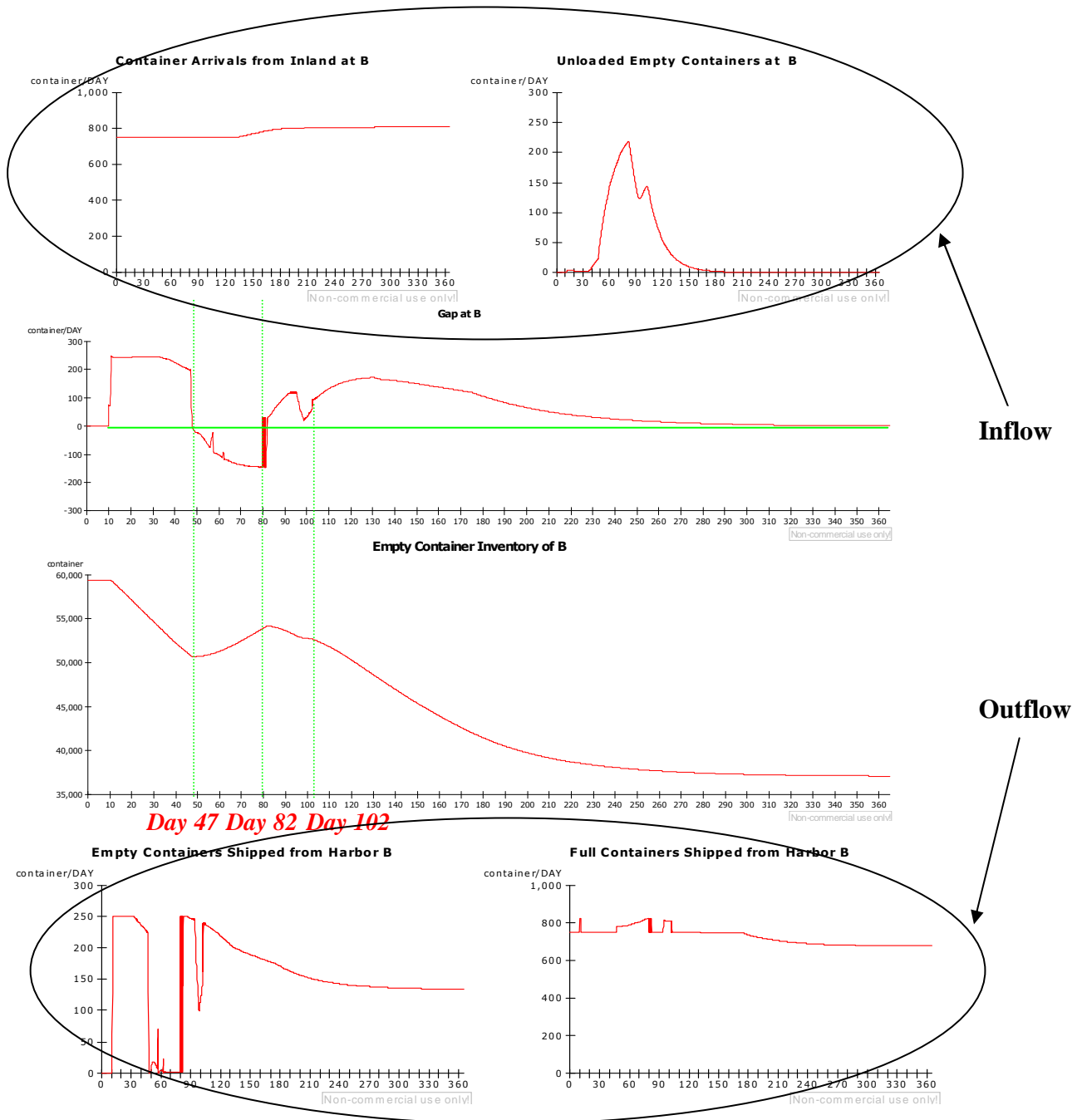


**Figure – 5.26**  
**Average Gap at B**

**Figure – 5.26** shows that the average gap is over ZERO. Therefore the empty container inventory of B declines. The high level of the average gap demonstrates that the discrepancy between the outflow and inflow is high and the outflow is larger than the inflow; and this causes a decline in the empty container inventory in harbor B.

***Inventory B is Analyzed with a Step Increase Application on the Demand***

The demand for freight transportation is increased with a step function and the behavior of the empty container inventory in harbor B is analyzed. The step increase is applied on day 10. **Figure – 5.24** shows the behavior of the empty container inventory in harbor B with the random increase application on the demand; i.e., the same reference scenario is generated with a step increase instead of a random function. **Figure – 5.26** shows the behavior of the empty container inventory in harbor B with a step increase application on the demand. In this part, **Figure – 5.24** and **Figure – 5.26** are compared and analyzed.



**Figure – 5.27**  
**Outcomes of the Discrepancy between the Received and Shipped Container**  
**Volume and the Empty Container Inventory at B**  
**(Discrepancy is Generated with Step Increase in the Demand)**

**Figure – 5.27** the graph of empty container inventory shows that the inventory is in equilibrium between day ZERO and day 11. The step increase is applied on day 10. Due to the pre-shipment planning time which is 1 day, the empty container inventory declines on day 11. The decline in

the inventory begins on day 11 and the decrease continues until day 47. Between day 47 and day 82, the empty container inventory in harbor B increases. Between day 82 and day 102 there is a slight decrease in the empty container inventory of B. Day 11, day 47, day 82 and day 102 are the critical days for the empty inventory of harbor B which the step increase is applied to. Day 1, day 37, day 72 and day 92 are the critical days for the empty container inventory of harbor B which the random increase application on the demand is applied to. (*See Figure – 5.24*)

The reference scenario created by the random increase (*Figure – 5.24*) compared to the reference scenario created by the step increase (*Figure – 5.27*), the empty container inventory in the reference scenario created by the step increase replicates the empty container inventory in the reference scenario created by the random increase with a 10 day delay.

### ***5.3.3 Inventory C***

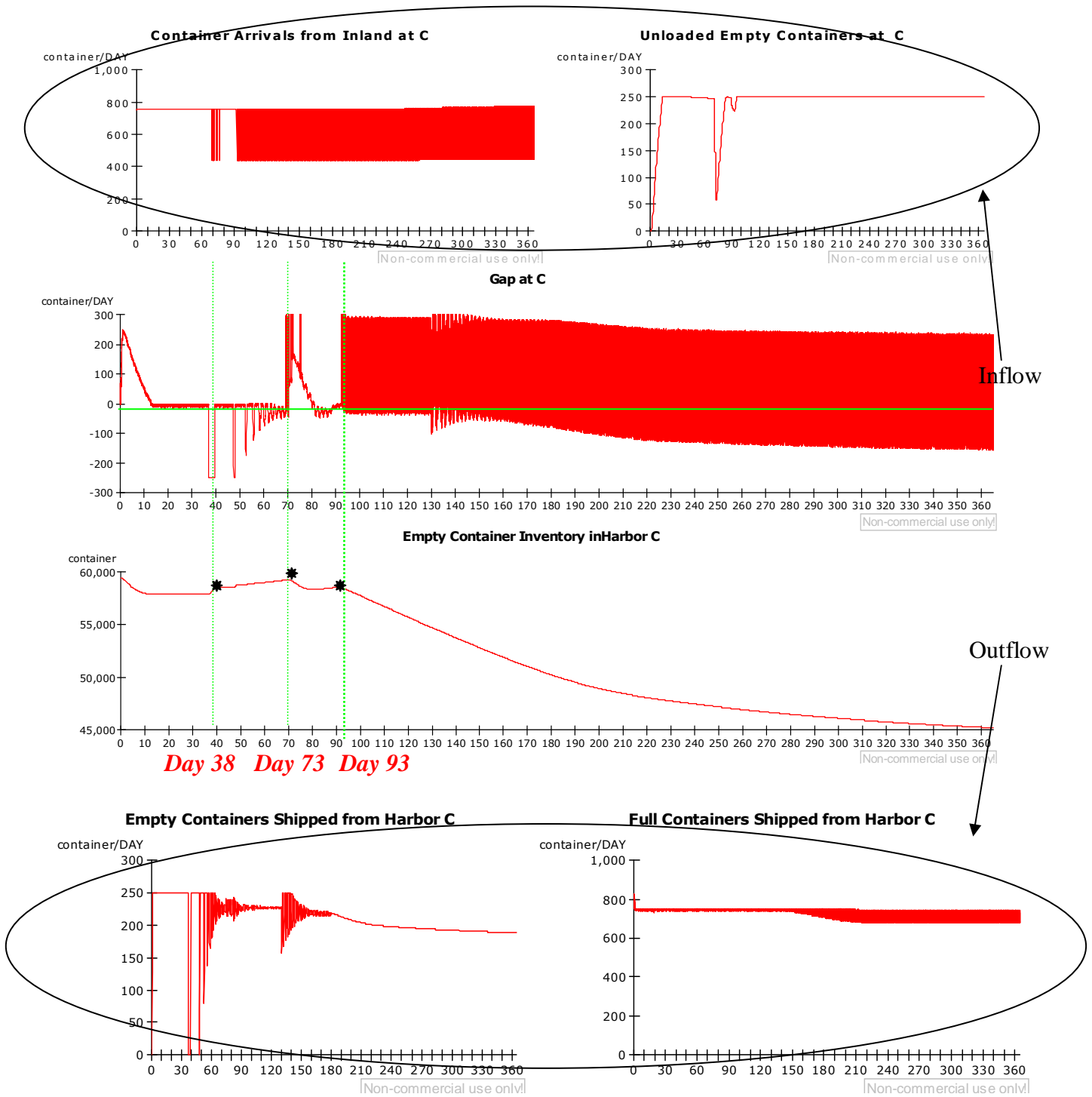
Empty container inventory in harbor C is analyzed in four phases:

- **Day ZERO - Day 38**
- **Day 38 - Day 73**
- **Day 73 - Day 93**
- **After Day 93**

*Figure – 5.28* depicts the empty container inventory level, the empty container arrivals from inland, the empty container arrivals from the other harbors, the full containers shipped from harbor C and the empty containers shipped from harbor C. The empty container arrivals from inland, the empty container arrivals from the other harbors are the inflows. Moreover, the full containers shipped from harbor C and the empty containers shipped from harbor C are the outflows of the empty container inventory in harbor C. The graph “Gap at C” shows the discrepancy between the outflow and the inflow in harbor C.

#### ***Day 0 - Day 38***

In reference scenario the reference demand increases on day ZERO. The gap increases with a 1 day delay. It was explained that the pre-shipment planning facility is simulated with a 7 order 1 day material delay. Gap at C declines between day 1 and day 12 and on day 12 the gap is equal to ZERO. The empty container inventory declines with the increased gap and the decline end on day 12 when gap is equal to ZERO.



**Figure – 5.28**  
*Outcomes of the Discrepancy between the Received and Shipped Container Volume and the Empty Container Inventory in Harbor C*

Between day 12 and day 38 the gap is stable; therefore the empty container inventory is stable. On day 38 the gap declines to below ZERO; i.e. the volume of the inflow increases on day 38.



On day ZERO and day 38, the volume of the empty containers shipped from harbor C is 250 per day. On day 38 this volume declines to ZERO.

#### ***Day 38 –Day 73***

Gap declines to ZERO on day 38. It is concluded that this decline is related to the decline in the empty container shipments from harbor C. Harbor C is mainly supplying harbor A. **Figure – 5.19** shows that on day 37 the empty container inventory in harbor A reaches a peak. Therefore the volume of the empty containers to be shipped to harbor A declined to ZERO. The decline in the empty container shipments decreases one of the outflows of the empty container inventory in harbor C; thus the gap declines. The gap fluctuates between day 38 and day 73; however the gap is around ZERO and below ZERO in general. Therefore the empty container inventory in harbor C keeps roughly the same level between day 38 and day 73.

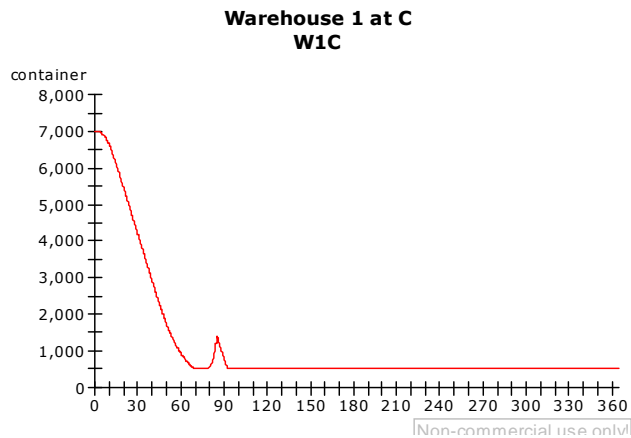
#### ***Day 73 – Day 93***

The gap is fluctuating and is over ZERO and around ZERO; therefore the empty container inventory declines very slightly between day 73 and day 93. It is concluded that the fluctuations in the gap is related to the volume of the empty container arrivals from the inland at C. **Figure – 5.28** depicts that the volume of the empty container arrivals from the inland at C fluctuates between day 73 and day 81. The fluctuations on the graph of “Empty Container Arrivals from the Inland at C” on **Figure – 5.28** shows that the volume of the containers transported from the inland declines. The decline in the volume of the empty containers transported from the inland reduces the volume of the inflow of the empty container inventory in harbor C; because the volume of the empty containers transported from the inland is one of the inflows of the empty container inventory in harbor C. Thus; the gap increases. On day 93 the gap begins to fluctuate very strongly between ZERO empty container transportation and 300 empty container transportations per day.

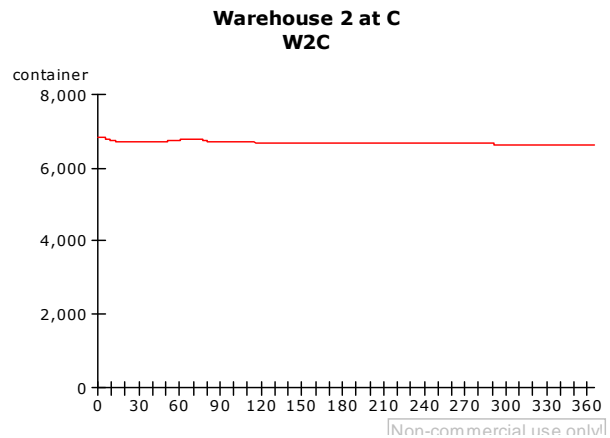
#### ***After Day 93***

On day 93 the gap begins to fluctuate very strongly between ZERO and 300 empty container transportations. The volume of the gap is over ZERO on average. Therefore the empty container inventory declines after day 93. It is concluded that the strong fluctuation in the gap is related to the empty container arrivals from inland at C. “Empty Container Arrivals from the Inland at C” on **Figure – 5.28** shows that the volume of the containers transported from the inland begins to fluctuate on day 93. The fluctuation in the volume of the containers transported from the inland is

scrutinized. The container inventory levels of Warehouse 1 and Warehouse 2 are examined. The fluctuation in the volume of the empty containers transported from the inland is related to the empty container inventories of the warehouses. *Figure – 5.29* and *Figure – 5.30* depict the empty container inventory levels of the warehouses at C.



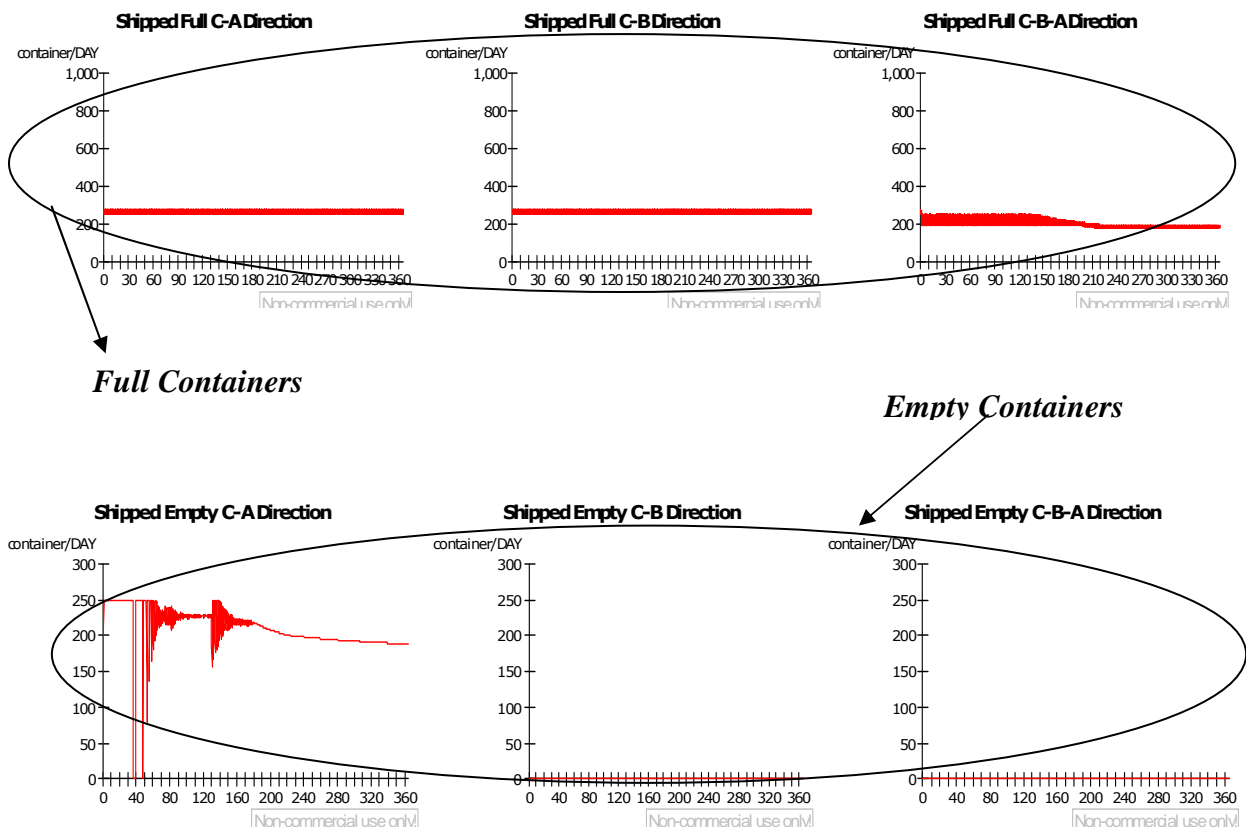
*Figure – 5.29*  
*Empty Container Inventory of Warehouse 1 at C*



*Figure – 5.30*  
*Empty Container Inventory of Warehouse 2 at C*

While empty container inventory level of Warehouse 2 is almost at its desired level, the empty container inventory level of Warehouse 1 declines very strongly in a short time; and after day 93 the empty container inventory is 500 containers. While the volume of the containers Warehouse 1 transports to harbor C declines, Warehouse 2 goes on supplying harbor C. The volume of the empty containers transported from the inland is an important inflow of the harbor. After day 93, empty container inventory of Warehouse 1 declines to a critical level. The main object of the warehouse is delivering the full containers to the customers. It is assumed that everyday on each land of A, B and C each warehouse delivers 500 containers. On each land there are two warehouses and on each warehouse area it is assumed that there are 50 clients whom delivered 10 containers everyday constantly; i.e. on each land 1,000 containers are delivered to the clients. Therefore each warehouse has to have minimum 500 containers in its container inventory to fulfill its mission. At the same time, the harbor sends demand to the warehouses for empty container transportation from the warehouse to the harbor. Due to the critical level, Warehouse 1 at C keeps the minimum volume of containers to fulfill its deliveries and cannot transport empty containers to harbor C everyday. Warehouse 1C can send empty containers to the harbor when the volume of the containers in the empty container inventory is over 500 containers; i.e. the level of the empty container inventory of Warehouse 1 is over 500, it transports containers to harbor C.

That creates the fluctuation on the volume of the empty containers transported from inland C. The declines and fluctuations in the volume of the empty containers transported from the inland decrease the inflow of the empty container inventory in harbor C; thus the discrepancy between the inflow and outflow increases and the empty container inventory level in harbor C declines. The decline is increasing between day 93 and day 200 and then the decline decreases after day 200. The decrease in the decline on day 200 is related to the decline in the volume of the containers shipped full from harbor C to C-B-A direction; i.e. the decline in one of the outflows. (See Figure – 5.31)

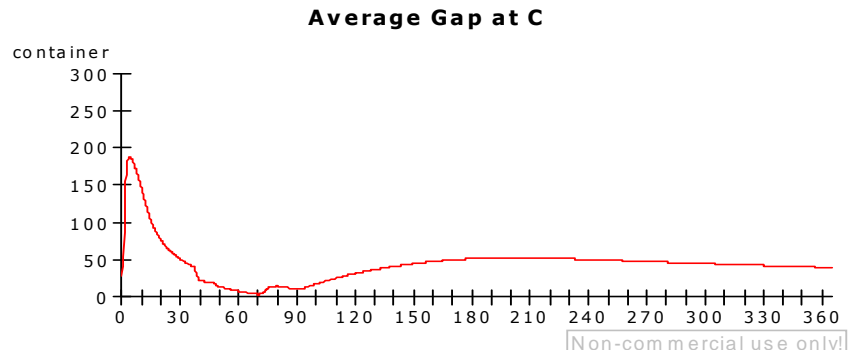


**Figure – 5.31**  
**Volume of the Empty and Full Containers Shipped From Harbor C**

Harbor C is shipping full containers to C-A, C-B and C-B-A directions. In the reference scenario, the volume of the demand for transportation to C-A, C-B and C-B-A from harbor C directions requires 275 containers/day equally. **Figure – 5.31** shows that the full containers shipped from harbor C to C-A and C-B direction is roughly 250 containers; whereas the volume of the full container shipments is around 200 for C-B-A direction. This situation demonstrates that the harbor rejected some transportation demands to C-B-A direction; i.e. some demand for

transportation to C-B-A direction was turned down due to lack of capacity. The volume of the demand rejected is subtracted from the transportation demand to direction C-B-A. The subtraction is done from the shipment direction because of C-B-A having the 3<sup>rd</sup> priority.

**Figure – 5.31** shows that harbor C is supplying mainly harbor A with empty containers.



**Figure – 5.32**  
**Average Gap at C**

**Figure – 5.32** shows that the discrepancy between the inflow and outflow is above ZERO; i.e. the outflow is larger than the inflow and this discrepancy causes the empty container inventory of C to decline.

#### **5.4 Policies Applied to the Model**

It was emphasized that the main problems of the container logistics are the high volume of empty container movements and the high level of idle container ratio (*See Chapter I, 1.1 Brief Problem Statement.*) All the policies are applied to the reference scenario to decrease the high volume of empty container movements and the idle container ratio. Moreover, harbor A’s productivity is calculated in detail. The productivity of harbor A is calculated by two means: annual throughput loaded/unloaded is calculated as tonnage, annual throughput loaded/unloaded in harbor A is calculated as number of containers. The consequences of these applications for low container movement, low idle container level and higher harbor productivity level are analyzed by comparing the outcomes of these applications to the reference scenario.

The policies applied to the reference scenario:

- ❑ **Policy-1** : Inland Transportation Capacity Increased 10%
  - **Policy-1.1** : Ramp Function
  - **Policy-1.2** : Step Function
- ❑ **Policy-2** : Loading/Unloading Capacity Increased 10%

- ❑ **Policy-3** : Customer Container Holding Time is Reduced to 3 Days
- ❑ **Policy-4** : Oversea Transportation Time is Reduced 1 Day by Designing Faster Ocean Carriers
- ❑ **Policy-5** : Unloading Cranes' Capacities Increased by Purchasing a 250 container Unloading Capacity Crane
- ❑ **Policy-6** : Ocean Carriers Carrying Capacities Decreased to 1,000 containers
- ❑ **Policy-7** : The Number of Containers and the Demand Increased 7% (The Empty Container Inventories in the Harbors Increased with a Step Function)
- ❑ **Policy-8** : The Number of Containers and the Demand Increased 7% (The Empty Container Inventories in the Warehouses Increased with a Step Function)
- ❑ **Policy-9**: W1C is Supplied by Leasing Containers.

#### 5.4.1 *Inland Transportation Capacity Increased 10%*

The reference scenario is subjected to a 10% inland transportation capacity increase. The purpose for the increase is closing the gap between the number of containers shipped from the harbor and the volume of the containers arrived at the harbor from the inland. Two sorts of increases are applied to the reference scenario: the inland transportation capacity is increased 10% with a step function, and an increase beginning on the day ZERO and peaking at 10% on the day of 365 is applied.

An increase beginning on the day of ZERO and reaching at 10% level on the day of 365 is concluded to be more compatible to the realistic situation. This aspect replicates a more realistic situation. However, the outcomes of this application can be recognized with a long time delay. Therefore, the outcomes are evaluated in two time horizons: 750 days and 1500 days. The increase beginning on the day of ZERO and reaching at 10% level on the day of 365 is generated by a **RAMP** function. *Figure – 5.33* represents that the increase in the capacity begins on the day ZERO and ends up on the day of 365.

The formulation is done:

$(IF(TIME \geq 365 \ll @day \gg, RAMP(0 \ll 1/day \gg * 1 \ll container/day \gg, STARTTIME) + 335.5 \ll container/day \gg, 305 \ll container/day \gg + RAMP(0.083561643835616438361 \ll 1/day \gg * 1 \ll container/day \gg, STARTTIME))) + 0 \ll container/day \gg$

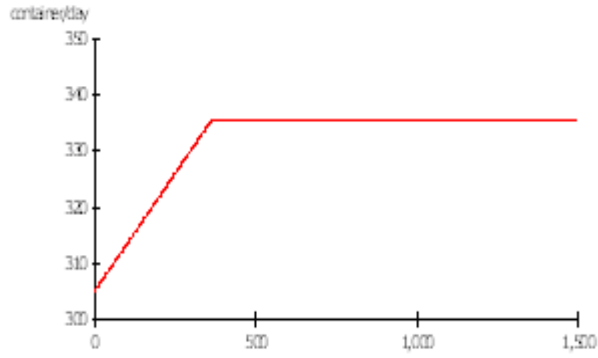


Figure – 5.33

*Each Inland Transportation Mode's Transportation Capacity is Increased 10%*

*Policy - 1.1 in a 750 day period,*

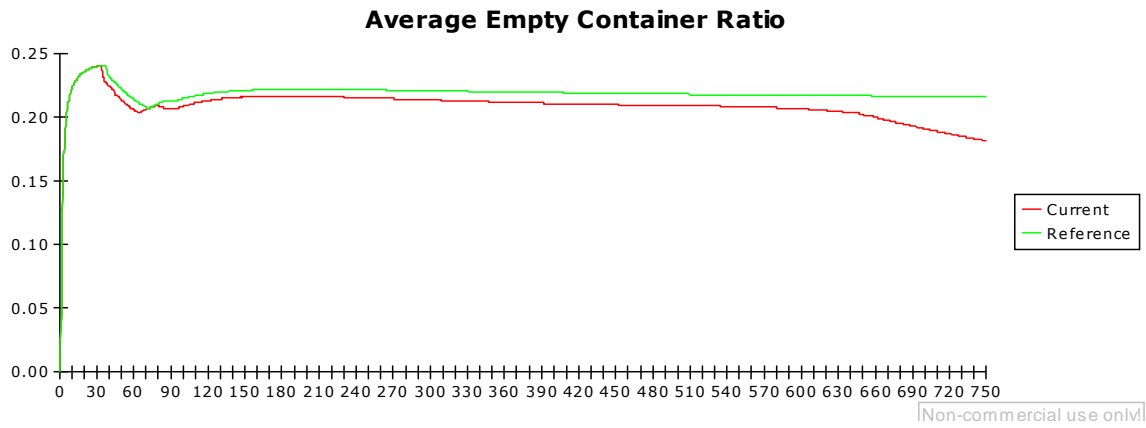


Figure – 5.34

*Policy - 1.1 : Average Empty Container Ratio  
(750 Day Period)*

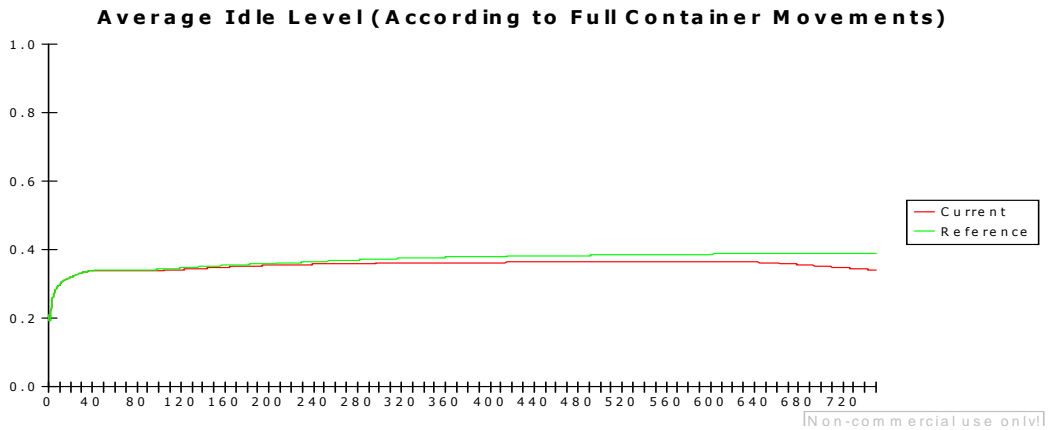


Figure – 5.35

*Policy - 1.1: Average Idle Container Level (750 Day Period)*

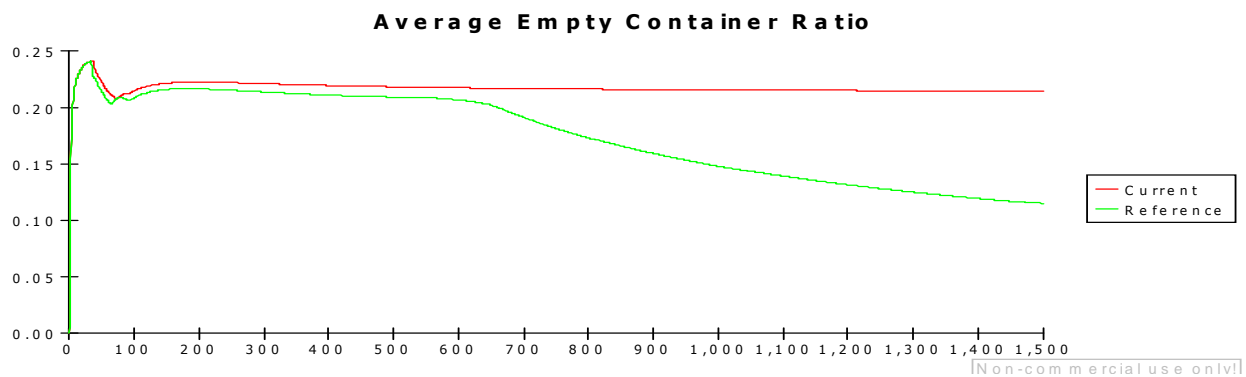
**Figure – 5.35** demonstrates the outcomes of this policy application in 750 days period. The results are compared to the reference scenario. The average empty container ratio is 22.014% in the reference scenario. Inland capacity increased 10%, the ratio declines to 18.16%.

The average idle level of containers is 37.86% in the reference scenario. Inland capacity increased 10%, the average idle level of containers declines to 34.25% (*See Figure – 5.35*).

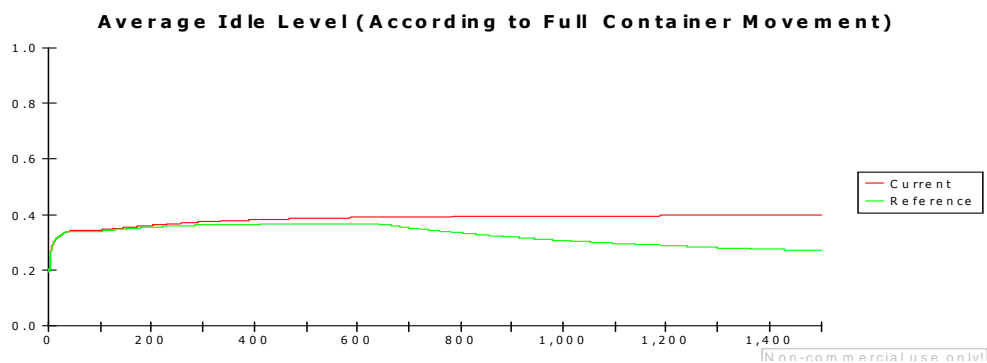
**Figure – 5.34** shows that outcomes of the policy application are more obvious from day 640 on.

This situation is concluded as: the outcomes of the increase in the capacity should be evaluated in long time horizon. Therefore, the policy is simulated in 1500 day time horizon

**In a 1500 day period,**



**Figure – 5.36**  
**Policy - 1.1: Average Empty Container Movements**  
**(1500 Day Period)**



**Figure – 5.37**  
**Policy - 1.1: Average Idle Level of Containers (1500 Day Period)**

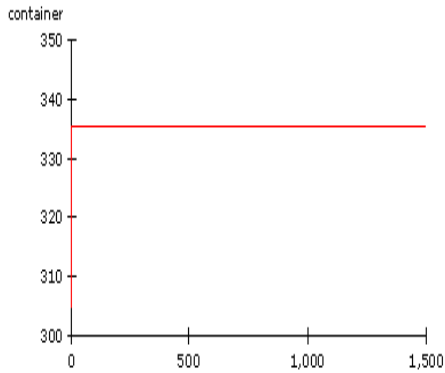
**Figure – 5.36** and **Figure – 5.37** show the outcomes of a 10% inland capacity increase in a 1500 day time horizon. **Figure – 5.36** compares the empty container ratio in reference scenario to the 10% capacity increased situation. **Figure – 5.36** depicts that the empty container ratio level of

22.014% declines to 11.48% 1500 days later, and **Figure – 5.37** depicts that the idle ratio declines from 39.76% to 26.98%.

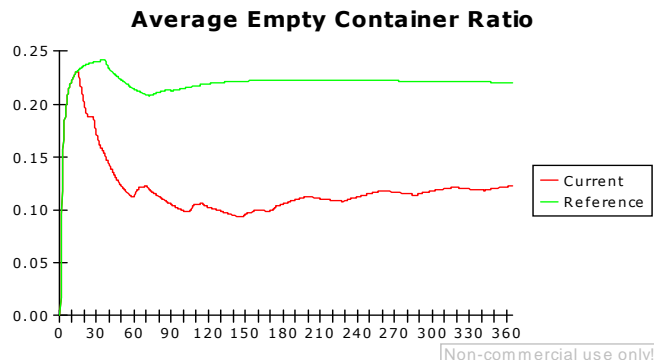
**Policy - 1.2: Step Function Increase**

The inland capacity is increased with a step function. A step increase is useful to observe the outcomes in a very short period. Therefore a 10% sudden increase is created with a **STEP** function. The step increase occurs on day 2.

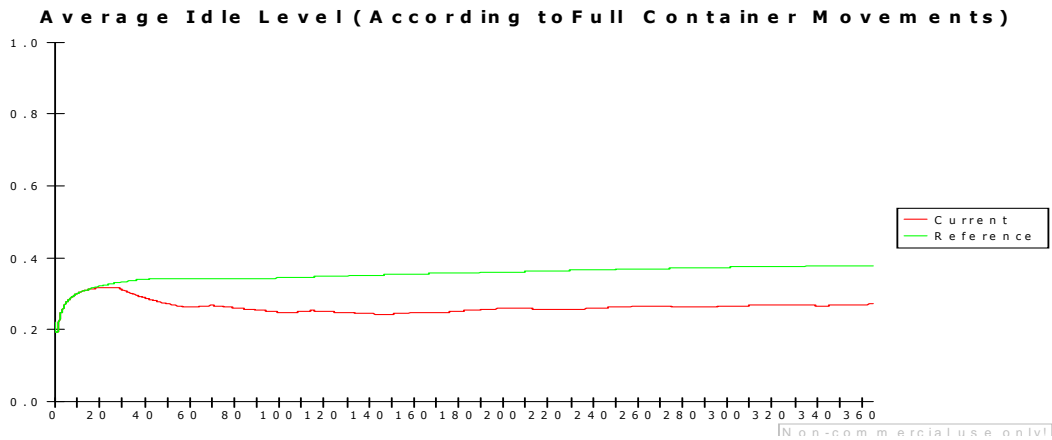
**305<<container>>+STEP(30.5<<container>>,2<<day>>+STARTTIME)**



**Figure – 5.38**  
**Inland Capacity Increased 10% with a Step Function (Policy - 1.2)**



**Figure – 5.39**  
**Policy - 1.2 : Average Empty Container Ratio**



**Figure – 5.40**  
**Policy - 1.2 : Average Idle Level of Containers**

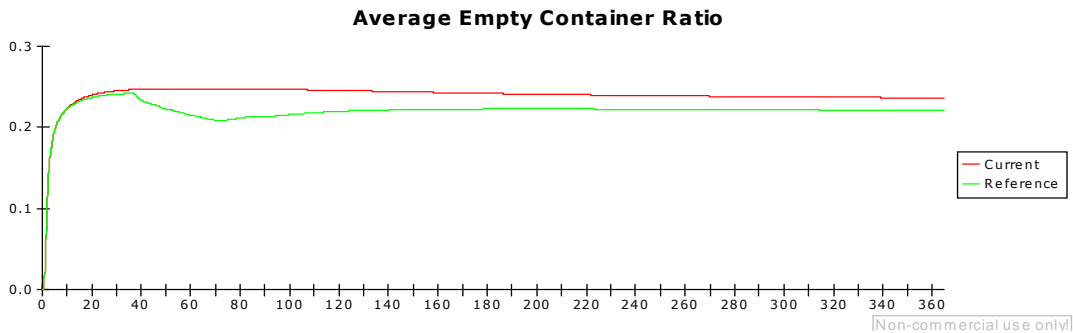
The results are compared to the reference scenario. **Figure – 5.39** shows that the average empty container ratio is 22.014% in the reference scenario. 10% increase is applied to the inland capacity with a step function, the average empty container ratio declines to 12.27%. **Figure – 5.40** shows that the average idle container ratio declines from 37.86% to 27.01%.



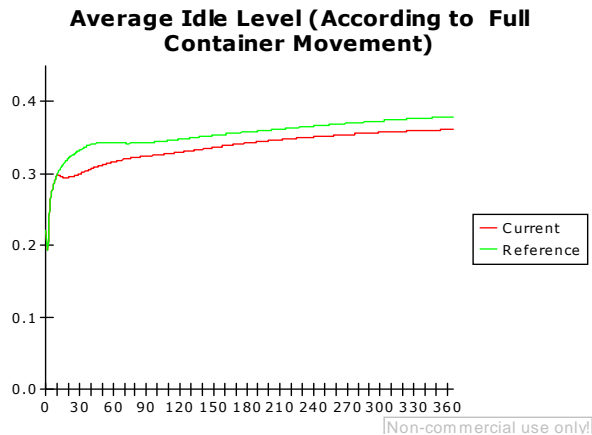
Consequently, a capacity increase can be a feasible policy to reduce the empty container movements. It should be underlined that, the outcomes of an increase in inland transportation capacity should not be evaluated in a very short time period. The expectations should be evaluated at least in 2 year period.

**5.4.2 Policy – 2 : 10% Increase in the Loading/Unloading Capacity**

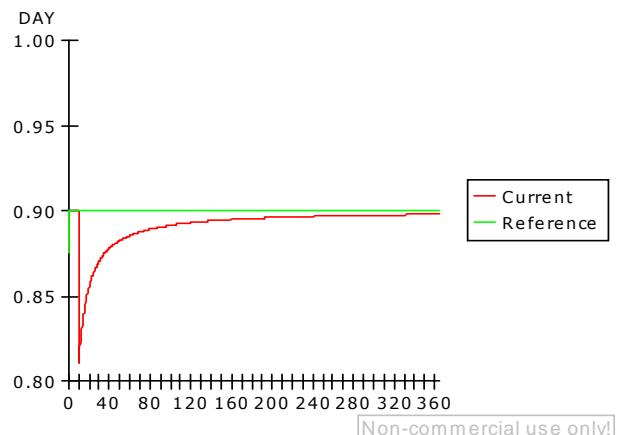
10% increase in loading/unloading capacity is applied as a policy. It is assumed that the loading/unloading capacity is increased by purchasing new equipments such as new cranes.



**Figure – 5.41**  
**Policy – 2 : Average Empty Container Ratio**



**Figure – 5.42**  
**Policy – 2 : Average Idle Level**



**Figure – 5.43**  
**Policy – 2 : Harbor Productivity**  
*(Harbor Productivity is Calculated According to the Number of Containers Loaded/Unloaded)*

**Figure – 5.41** shows that the loading/unloading capacity increases, the empty container ratio increases 1.45 %. **Figure – 5.42** shows the average idle container level. The loading/unloading capacity increases 10%, the average idle container level decreases from 37.83% to 36.08%. While the empty container ratio (volume of the empty container movements) increases, the

average idle level of containers (unproductivity of containers) declines. It means that the number of the full containers moving is increasing when the loading/unloading capacity increases. Due to the increase in the loading/unloading capacity, more demand is accepted and more full containers are shipped.

The idle level of containers are calculated by two means: only a container moving full is productive, regardless of being full or empty, if a container is moving it is productive. The average idle level on *Figure – 5.42* is calculated according to the assumption that just a full container moving is productive. Therefore, the average idle level of the containers decreases with the increased number of full container movements. Moreover, the empty container ratio increases with the increased loading/unloading capacity, because the number of empty containers loaded/unloaded increased with the increased loading/unloading capacity.

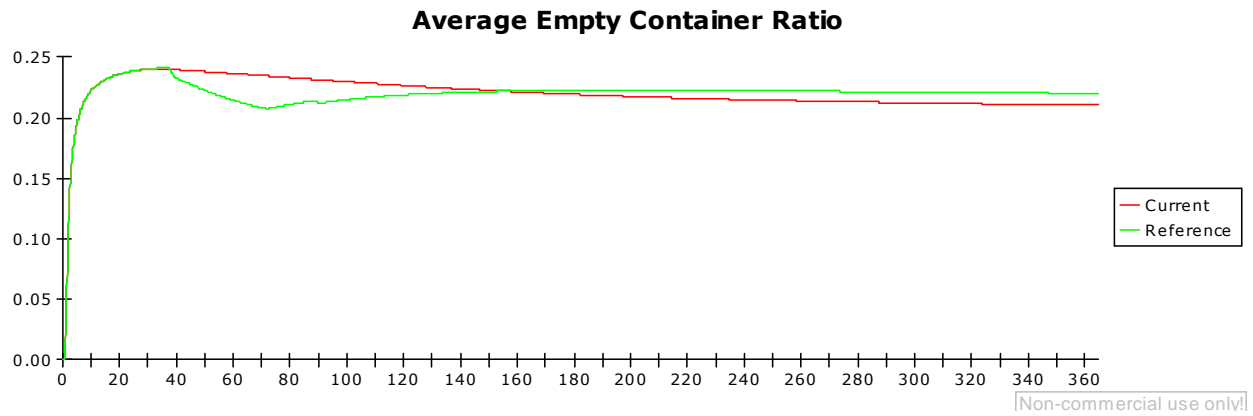
Consequently, capacity increase precipitates the container movements and this decreases the average idle level (increases the container productivity; but it is not a solution to attenuate the volume of the empty container flows.

*Figure – 5.43* shows the harbor productivity calculated according to the total number of containers loaded/unloaded annually (*See Chapter 4, 4.6.8 MODULE-8 Harbor Productivity*). The productivity of a harbor is calculated by two means: according to the total number of containers loaded/unloaded and according to the throughput as tonnage loaded/unloaded annually. The harbor productivity based on the total number of containers loaded/unloaded gives more accurate results and shows more fair values. Therefore the productivity based on the total number of containers loaded/unloaded is used as a reference. The loading/unloading capacity increases, the harbor productivity decreases; but this value is minor as to be neglected. Therefore, it is concluded that the capacity increase doesn't have a significant impact on the harbor productivity. Harbor productivity is more likely depending on how much efficiently the resources, the equipments and the capacities are allocated and utilized.

#### ***5.4.3 Policy – 3: Customer Container Holding Time is Reduced to 3 Days***

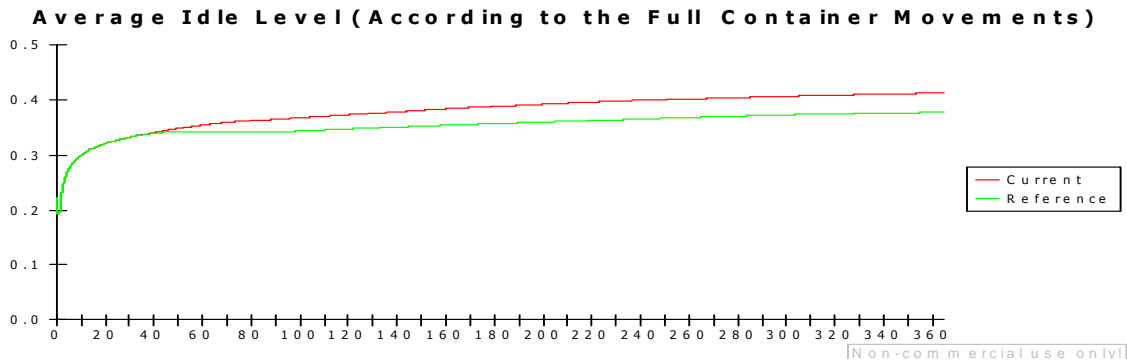
A customer can keep a container for 4 days in reference scenario. At the end of this time the container should be hand in back to the company. It is assumed that with *Policy – 3* application, the company commences to rule a more strict policy in container keeping time by reducing this time to 3 days. In this part this reduction is applied as a policy and the outcomes are evaluated

according to the average empty container rate, the container idle level and the harbor productivity.



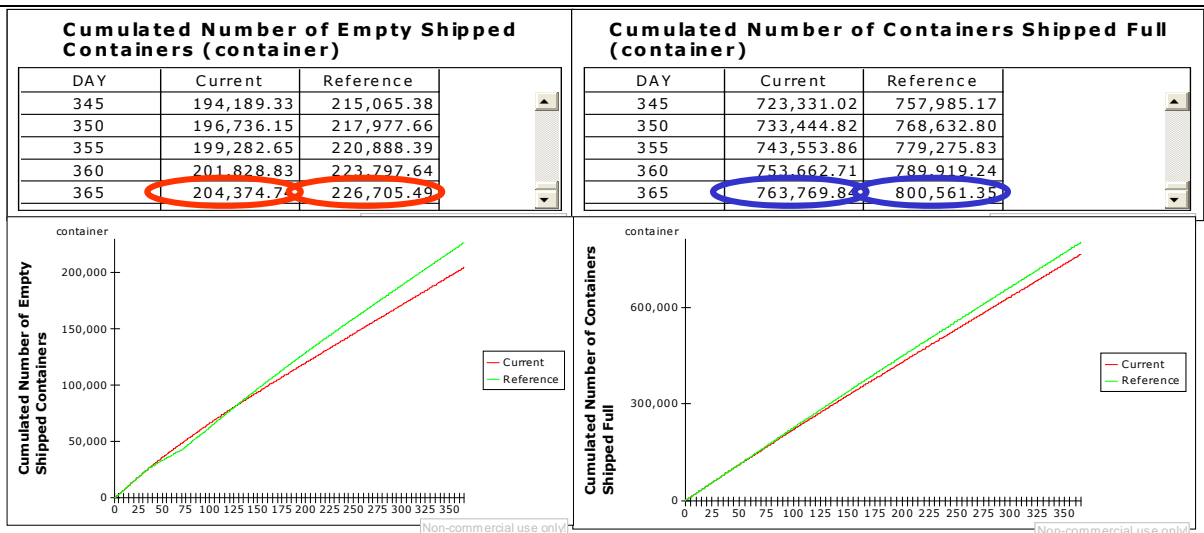
**Figure – 5.44**  
**Policy – 3 : Average Empty Container Ratio**

**Figure – 5.44** shows the average empty container ratio when the customer container keeping time is reduced to 3 days. The container keeping time reduced to 3 days, the average empty container ratio declines from 22% to around 21%.



**Figure – 5.45**  
**Policy – 3 : Average Idle Level (According to the Full Container Movements)**

The customer container keeping time reduced to 3 days, the average idle level increases and the empty container ratio decreases. Outcomes of **Policy – 3** application is showed on **Figure – 5.45** and a comparison is made with the reference scenario. **Policy – 3** applied, the average idle level increases from 37.83 % to 41.26%. A decrease in the empty container ratio (volume of the empty container movements) and an increase in the idle container level at the same time (unproductivity of a container) seem to be contradictory. A decrease in the empty container ratio occurs in a case of a decrease in the volume of empty containers shipped. The number of the empty containers shipped decreased, the number of full containers shipped is expected to increase. Therefore the

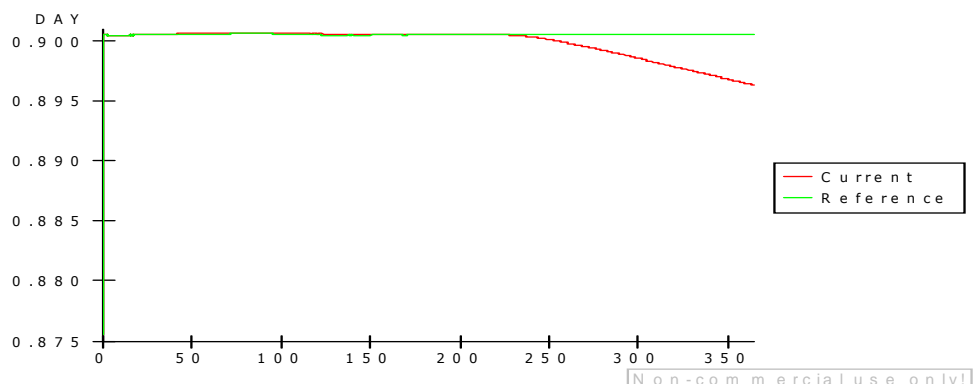


**Figure – 5.46**  
*Comparing the Cumulated Number of the Containers Shipped (Both Empty and Full) to the Reference Scenario*

idle level of containers is expected decline. Because the idle level is calculated based on the full container movements. A decline in the empty container movements should increase the full container movements and subsequently the idle level of containers should decrease. However, **Figure – 5.45** shows a direct contrary situation. In the beginning it was evaluated as a shortcoming of the model and a detailed analysis is done once more to find out the reason for this contradiction. The cumulated number of the containers shipped empty and full is calculated and this cumulated number is compared to cumulated number of empty and full containers shipped in the reference data. **Figure – 5.46** shows this comparison. The cumulated values of the containers revealed that after the application of the **Policy - 3** the number of the containers sent full or empty from each harbor declines. The cumulated volume of the full containers shipped declines to 763,000 containers from 800,000 containers and the cumulated volume of empty containers declines from 226,000 containers to 204,000 containers simultaneously. **Figure – 5.46** depicts the decline in the cumulated volume of empty and full shipments. The decline in the volume of the full container shipments is around 40,000 containers annually while the decline is around 22,000 containers in the volume of empty container shipments. The decline in the amount of full container shipments generates an increase in the idle container ratio. The more the full containers shipped, the less idle the containers are. Moreover, the decline in the volume of empty container shipments generates a decline in the empty container ratio. The few the empty containers shipped are, the less the empty container ratio is. As mentioned before, the containers are more productive with a decreased idle ratio, i.e. it means that the system sends and receives more full containers.

Therefore the empty container ratio is expected decline. The empty volume is decreasing and simultaneously the volume of the full containers shipped is declining as well. The container keeping time reduced to 3 days, the harbor is expected to supply itself faster from the inland warehouses, therefore the harbor is expected not to send demand for empty container transportation to the other harbors; i.e. few empty arrivals and few empty shipments are expected. It is concluded that the decline in both full and empty container shipments is related to the empty container levels in the harbors. The empty container inventory levels decline to critical levels, the harbors reduce the number of empty and full container shipments. The level of the empty container inventories has an impact on the filling, loading and unloading container operations. *(See Chapter 4, 4.6.10 MODULE-7 Filling Rate Planning at Harbor A)*

Reducing the client container keeping time renders the logistics system more dynamic, and the inventories in the harbors decline to critical levels; therefore the “Effect of Empty Containers On Capacity at A” and “Effect of Empty Containers on Shipping Empty Containers at A” begin to constrict the empty and full container loading rate. The level of the empty container inventory declines, the volume of the filling, loading and unloading operations declines. The productivity of the harbor declines with a declined loading/unloading capacity as well. **Figure – 5.47** shows the decline in the harbor productivity of harbor A. **Figure - 4.52** shows that the empty container level declines to critical level, the volume of the container loading/unloading operations slow down and reduced by the empty container inventory in the harbor. Although having the same loading/unloading capacity the harbor cannot load/unload containers due to the low level of container inventories and the restrictions on the container operations; thus the productivity of the harbor declines.

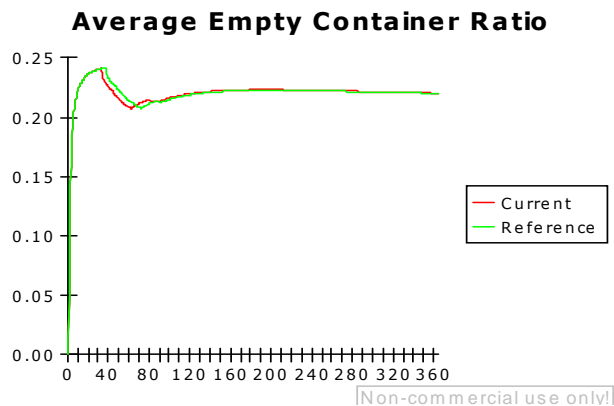


**Figure – 5.47**  
**Policy – 3 : the Harbor Productivity**

Consequently, ruling in a stricter customer policy by reducing the customer container keeping time to 3 days is not the best cure for reducing the volume of the empty container movements and for reducing the container idle level. It is concluded that *Policy – 3* is not useful.

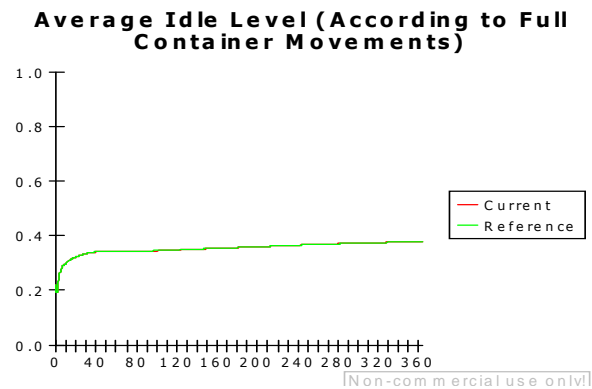
#### **5.4.4 Policy – 4: Oversea Transportation Time is Reduced by Designing Faster Ocean Carriers**

The average transportation time between the harbors is 17 days. It is assumed that faster ships are designed with the increased technology and the transportation time is declined to 16 days. Outcomes of this decline are analyzed in this part.



*Figure – 5.48*

*Policy – 4 : Average Empty Container Ratio*



*Figure – 5.49*

*Policy – 4 : Average Idle Container Level*

*Figure – 5.48* shows *Policy - 4* application and the empty container ratio. It is concluded that decreasing the transportation time by designing faster ships is not the best cure for reducing the volume of the empty container movements.

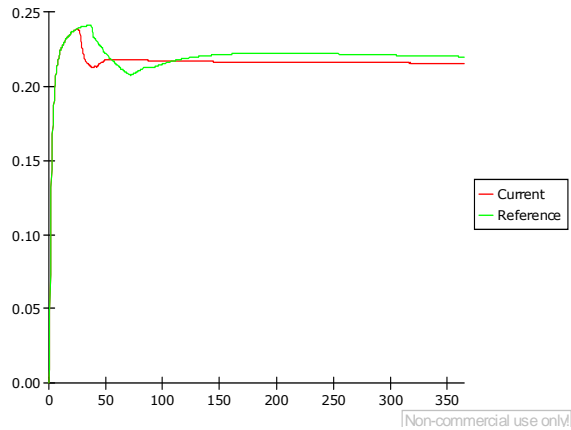
*Figure – 5.49* shows *Policy - 4* application and the idle level of containers. It is concluded that only decreasing the transportation time by designing faster ships is not the best cure for reducing the idle level of containers.

#### **5.4.5 Policy – 5 : Unloading Capacity Increased by Purchasing a 250 container Unloading Capacity Crane**

In the reference scenario the containers arriving at harbor A and B constitute a container accumulation problem. *Figure – 5.53* shows that big volume of containers are waiting in the ocean carriers to be unloaded in harbor A and *Figure – 5.55* shows that big volume of containers waiting in the ocean carriers to be unloaded in harbor C. The volume of the cumulated number of containers waiting to be unloaded in each harbor is depicted on *Figure – 5.53*, *Figure – 5.54* and *Figure – 5.55*. The problem is not caused by an inefficient shipping network design; the problem

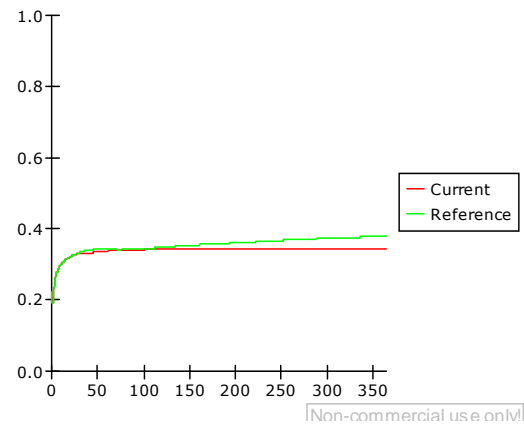
is caused by the low unloading capacity of the harbors. Compared to the loading capacity, the unloading capacity is almost 25% smaller. The gap between the loading and unloading capacity creates this accumulation.

By **Policy – 5** application, the unloading capacity increased 25% by purchasing a new crane and the outcomes of the policy application are analyzed.



**Figure – 5.50**

**Policy – 5: Empty Container Ratio**



**Figure – 5.51**

**Policy – 5 : Average Idle Container Level**

**Figure – 5.50** shows the outcome of increasing the unloading capacity 25%. The empty container ratio declines from 22.04% to 21.57% with the increase. The discrepancy between these two values is negligible.

**Figure – 5.52** shows the empty container inventories in the harbors. **Policy – 5** is applied, the level of the empty container inventory in harbor B declines to 52,000 containers. Moreover, the empty container level in harbor B is around 39,000 containers in the reference scenario. It is concluded that **Policy – 5** generates a more robust empty container inventory in harbor B.

**Figure – 5.53**, **Figure – 5.54** and **Figure – 5.55** depict that the unloading capacity increases 25%, the volume of the containers cumulated in the harbors declines to ZERO.

Consequently, it is concluded that increasing the unloading capacity isn't a cure for reducing the empty container ratio and the idle container ratio. However, this policy application reduces only the accumulation of the containers waiting to be unloaded as demonstrated on **Figure – 5.53**, **Figure – 5.54** and **Figure – 5.55**.

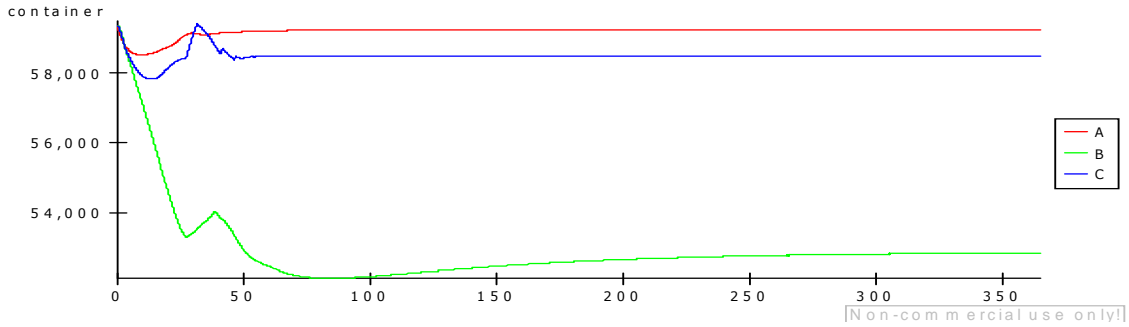


Figure – 5.52

Policy – 5 : Each Empty Container Inventory Level in Harbor A, B and C

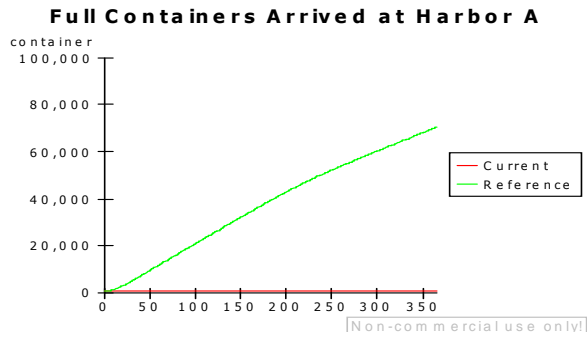


Figure – 5.53

Number of Containers Waiting to be Unloaded in Harbor A

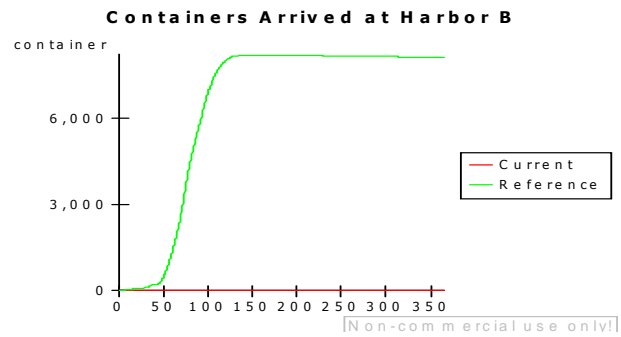


Figure – 5.54

Number of Containers Waiting to be Unloaded in Harbor B

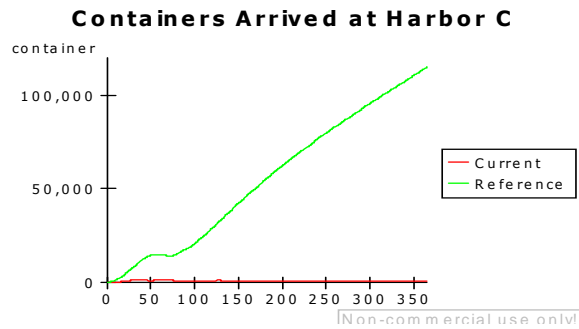


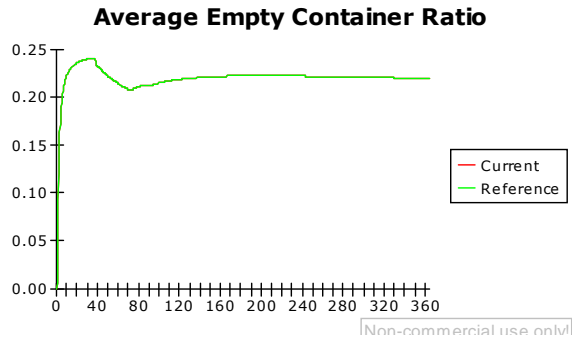
Figure – 5.55

Number of Containers Waiting to be Unloaded in Harbor C

#### 5.4.6 Policy – 6: Reducing the Ship Carrying Capacity to 1,000 Containers

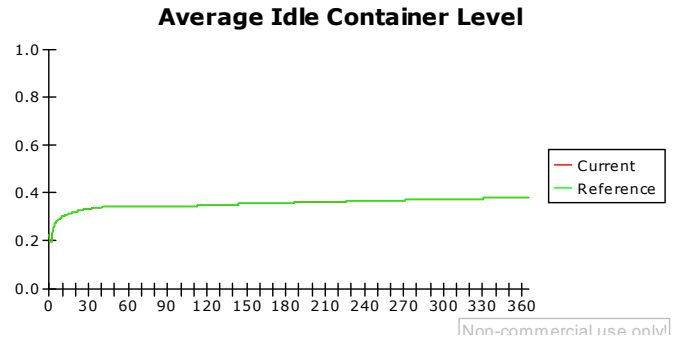
The average ship carrying capacity is 3,000 containers in the reference scenario. Carrying capacities of the ocean carriers are reduced to 1,000 containers and the outcomes are analyzed. **Figure – 5.56**, **Figure – 5.57** and **Figure – 5.58** show the average empty container ratio, the idle container ratio and the harbor productivity.





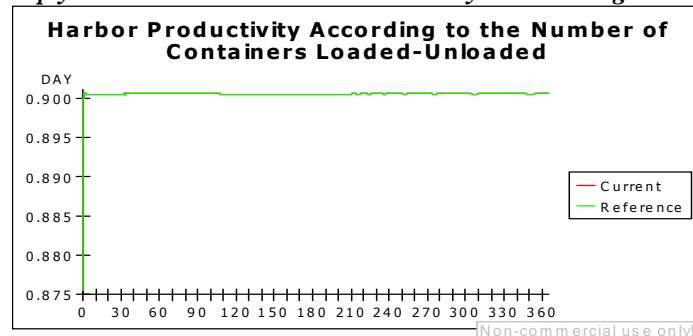
**Figure – 5.56**

**Policy – 5 : Average Empty Container Ratio**



**Figure – 5.57**

**Policy – 5 : Average Idle Container Level**



**Figure – 5.58**

**Policy – 5: Harbor Productivity Level.**

**Figure – 5.56, Figure – 5.57 and Figure – 5.58** demonstrate that the model is not sensitive to the modification in carrying capacities. Because “Harbor Berthing Conjunction” factor is excluded from the model. It is assumed that there is no waiting time to berth, a ship arriving at the harbor berths at once; therefore the capacity of the ships and the number of the ships sailing and berthing don’t have any impacts on the system. Thus; fulfilling the transportation with ocean carriers having smaller carrying capacities is not a cure to reduce the volume of the empty container movements and the idle container level.

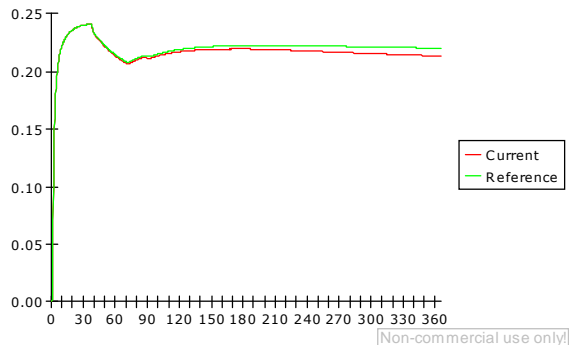
**5.4.7 Policy – 7: Number of Containers in the Harbors and the Demand for Transportation are increased 7%**

It is assumed that the demand for transportation will go on with an increase around 7% per year until the year 2015. (Helmick, Jon S, A 21st century status report, 2001). **Policy-7** is applied according this expectation. The demand and the container inventories are increased 7%. Each empty container inventory level of harbor A, B and C is 59,375 containers in the reference

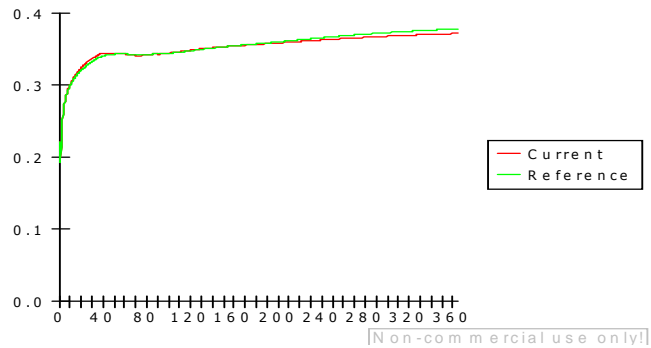
scenario and each harbor’s empty container inventory increased 6,570 containers with a **STEP** function on day 2.

The total volume of the demand for transportation is 83,820 ton per day. (See **Figure – 5. 11**). The demand for transportation increased 7% on day 2 as well.

**Figure – 5.59** and **Figure – 5.60** depict the empty container ratio and the average idle container level. **Figure – 5.59** show that **Policy – 7** application decreases the volume of empty container movements, but the decrease is very small and negligible.



**Figure – 5.59**  
**Policy – 7 : Empty Container Ratio**



**Figure – 5.60**  
**Policy – 7 : Average Idle Level**

**Figure – 5.60** show that **Policy – 7** application decreases the average idle level of containers, but the volume of the decrease is very small and that amount can be neglected.

It is concluded that **Policy – 7** is not a cure to reduce the volume of the empty container movements and the idle container level.

**5.4.8 Policy - 8: Number of Containers in the Warehouses and the Demand for Transportation is increased 7%**

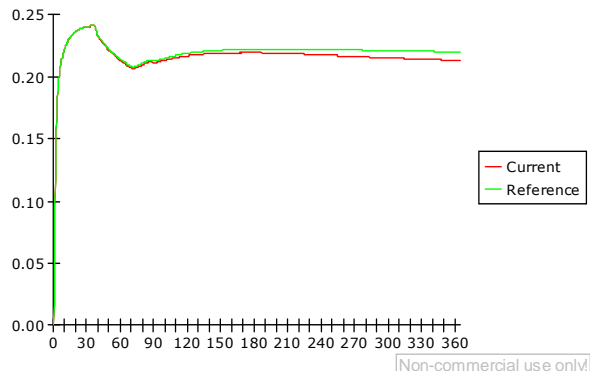
	Warehouse -1	Warehouse -2
A	7,125	7,125
B	7,000	7,000
C	7,000	6,847

**Figure – 5.61**  
**Empty Container Inventory Levels of the Warehouses in Reference Scenario**

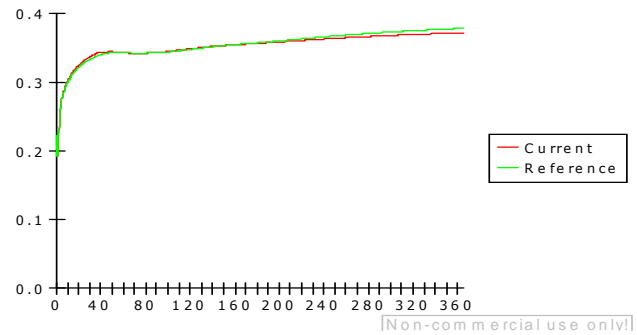
	Warehouse -1	Warehouse -2
A	10,450	10,450
B	10,300	10,300
C	10,300	10,147

**Figure – 5.62**  
**Policy – 8 : Empty Container Inventory Levels of the Warehouses**

The number of containers in the warehouse inventories and the demand for transportation is increased 7%. **Figure – 5.61** depicts each warehouse empty container inventory level in the reference scenario. **Figure – 5.62** depicts each warehouse empty container inventory level when **Policy – 8** is applied.



**Figure – 5.63**  
**Policy – 8 : Empty Container Ratio**



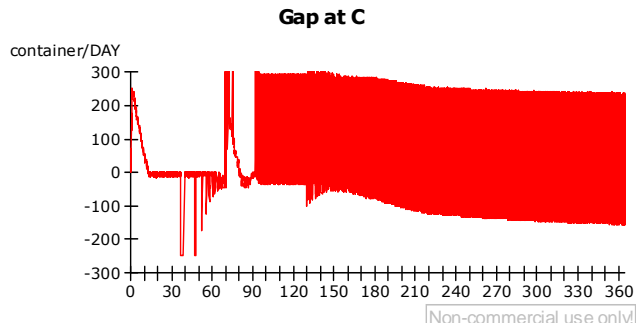
**Figure – 5.64**  
**Policy – 8 : Average Idle Level**

**Figure – 5.63** shows the volume of the empty container movements and **Figure – 5.64** shows the average idle container level. **Figure – 5.63** demonstrates that the demand and the volume of the empty containers in the warehouses increase, the volume of the empty container movements declines, but this value is very small and negligible. **Figure – 5.64** demonstrates that the demand and the volume of the empty containers in the warehouses increase, the average idle container level declines, but this value is very small and negligible.

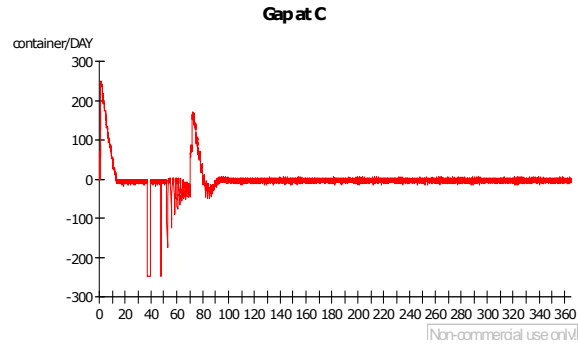
Consequently, it is concluded that **Policy – 8** doesn't establish a solution to reduce the volume of the empty container movements and the idle container level.

#### **5.4.9 Policy – 9: Empty Container Inventory of Warehouse – 1 C is Supplied with Leasing Containers**

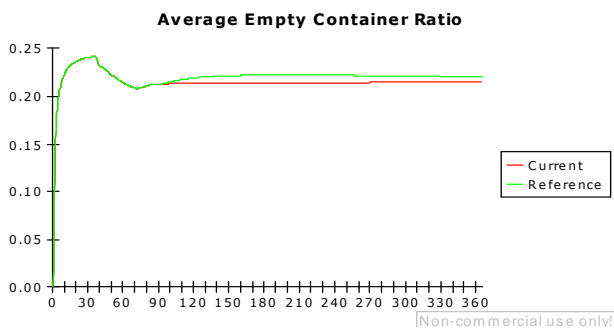
While analyzing inventory C it was revealed that Warehouse 1 at C declines very strongly and has difficulty to supply harbor C. (See **Figure – 5.29**). It was concluded that the strong decline in the empty container level of Warehouse 1 C generates oscillations in the volume of the empty containers transported from warehouse-1 C to harbor C. The oscillations in the volume of the empty containers transported from the inland to harbor C occurs on day 93 (See **Figure – 5.28 Graph of “Container Arrivals from C” and Graph of “Gap at C”**). **Policy – 9** is applied to reduce the volume of the empty container movements, the average idle container level and the oscillations in the volume of the containers transported from Warehouse 1 C to harbor C.



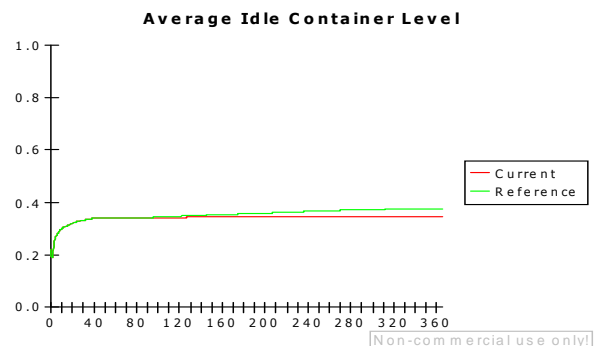
**Figure – 5.65**  
**Gap at C in Reference Scenario**



**Figure – 5.66**  
**Policy – 9 : Gap at C**



**Figure – 5.67**  
**Policy – 9 : Volume of Empty Container Movements**



**Figure – 5.68**  
**Policy – 9 : Idle Container Level**

**Figure – 5.65** shows the oscillations in the volume of the gap between the inflow and the outflow in harbor C in reference scenario. **Policy – 9** applied, i.e. Warehouse 1 C is supplied by leasing containers, the oscillations declines obviously and **Figure – 5.66** demonstrates the decline in the oscillations. Moreover **Figure – 5.67** shows the volume of the empty containers movements. Compared to the volume of the empty container movements in the reference scenario, **Figure – 5.67** demonstrates that the volume of the empty containers decline when **Policy – 9** is applied. The decline is around 1%. **Figure – 5.68** shows the idle container level. **Policy – 9** applied, the idle container level declines. The decline in the idle container level is around 1%. Consequently, it is concluded that **Policy – 9** successful in reducing the oscillations in the volume of the empty containers transported from Warehouse 1 C to Harbor C. On the other hand, **Policy – 9** doesn't cure the problems of high volume of empty container movements and the idle container level. The amelioration in these two problems is around 1% when **Policy-9** is applied.

# CHAPTER VI

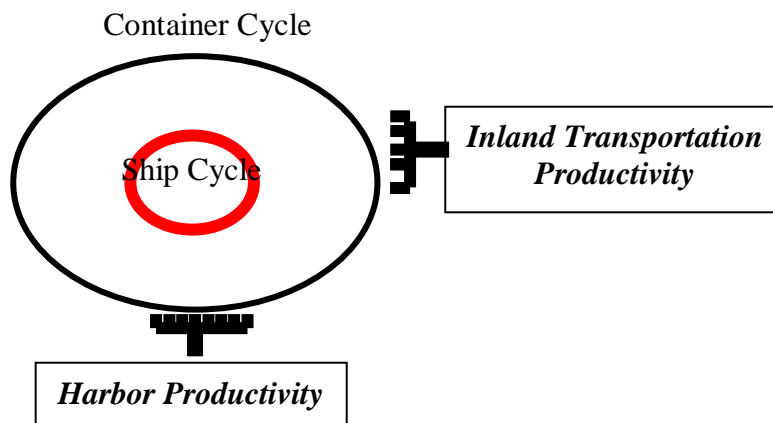
## 6. CONCLUSIONS

This study attempted to draw a mental picture of the container flows and the internal dynamics of structure that the containers flow in. The intermodal logistics structure has a big dynamism and the behavior of the system is far beyond complex to perceive. System Dynamics aspect is used as an usher while leading through this complex and dynamic path.

Harbor productivity is created based on two assumptions: the total throughput as container number and the total throughput as tonnage. It is observed that the calculations based on the total throughput as container numbers is more sensitive. Because, the calculations depending on the tonnage are neglecting the empty container movements. Therefore; while the harbor productivity is around 90% according to the throughput as container numbers, the productivity is around 70% when the total throughput is calculated as tonnage.

First of all, the internal dynamics of the container logistics system is revealed and the mental picture drawn is evaluated. It is observed that there are two main cycles in the system: the container cycles, the ship cycles. These two cycles can be depicted as two telescopic cycles.

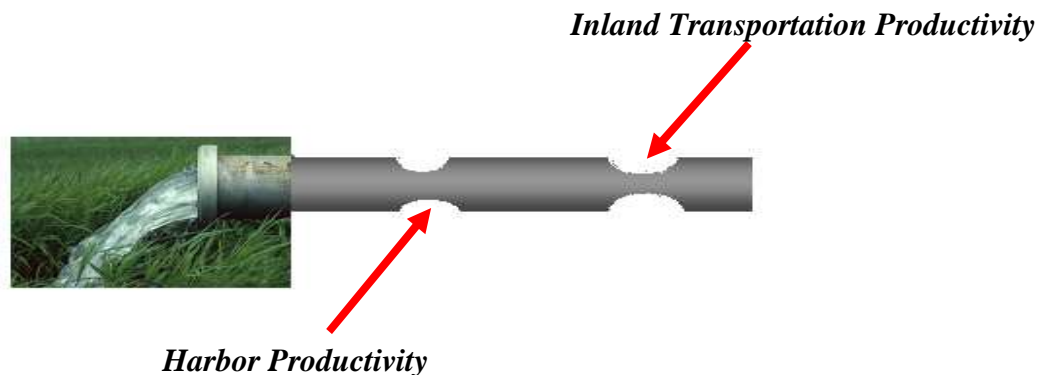
*Figure – 6.1* depicts this picture.



*Figure – 6.1*

*Mental Picture of the Cycles in the Logistics System*

The container cycle and the ship cycle effect each other's movement reciprocally. If the ship cycle slows down the container cycle slows down, and vice versa. The harbor productivity and the inland transportation productivity have a braking effect on these two cycles. This assumption is depicted on *Figure - 6.1*. If the harbor productivity is low then it slows down the container cycle movement due to the increased harbor operation times and the ships waiting for the loading operations wait more; therefore the ship cycle time increases as well. For a successful transportation, the ship cycle time and the container cycle time should be to synchronized and managed in optimum. The productivity problem has a chain effect. The declined productivity reduces the container productivity and the ship productivity; i.e. the owner of the containers and the ships cannot use their equipments properly. The outstanding feature of this system is that the system is as much fast as the slowest flow in the system or it is as much productive as the lowest productivity level in the system. This state resembles a pipe that the water is flowing through. The speed or the amount of the water is determined by the narrowest part of this pipe; i.e. the flow in the whole pipe is as fast as the water flowing through the narrowest point and the harbors and the inland facilities are these narrowest points in the water pipe.



*Figure – 6.2*  
*Mental Picture of the Harbor and Inland Operations in the Logistics System*

The narrow parts (Harbor and Inland) defined with System Dynamics aspect according to the mental picture drawn above. The empty container movements are one of the consequences of these narrow parts of the pipe. It is concluded that the inland transportation structure and its productivity are the main reasons for the empty container flows.

Nine policies are applied to the model and the outcomes are evaluated. It was observed that all the policies related to increase the container productivity in the inland or all the policies increasing the speed of the containers in the inland, reduced the volume of the empty container

flows. The policy increasing the inland capacity, and the policy reducing the customer container keeping time verify this assumption (*See Chapter 5, Part 5.4.1 Policy-1 and Part 5.4.3 Policy-3*). Accordingly, the studies focusing on increasing the inland operations' productivity should intensify. On the other hand, all the companies working in the logistics sector work with high profession profile. Namely, the companies are working with a productivity level very close to their optimum capacities or logistics abilities. Therefore new techniques focusing on increasing the inland operations productivity should be generated. Designing new ships and harbor equipments with new technology or purchasing new technology equipments require very high costs. The optimum way and the outcomes that can be harvested in the shortest period lie in the inland structure. Therefore the studies focusing on the inland structure constitute of big importance.

## References

Boile, M., Theofanis S., Golias M. and Mittal N. (2006) Empty Marine Container Management: Addressing Locally a Global Problem. *TRB Annual Meeting*.

Christiansen, Marill., Nygreen, Björn. (1998). Modelling Path Flows for a Combined Ship Routing and Inventory Management Problem. *Journal of Operational Research*.

Davidsen, Pål. (2007). Univerity of Bergen, GEO-304 Advanced System Dynamics Course Slides.

Fern, Li, Gan. (2006). Modeling Container Flows and Fleet Network Design for Feeder Shipping Services. Master Thesis in Transportation and Logistics.

Gambardella, Luca, Maria., Bontempi, Gianluca., Taillard, Eric., Romanego, Davide., Raso Guido., Piermari Pietro. (1998). Simulation and Forecasting in Intermodal Container Terminal. *Journal of Operational Research*.

Gambradella, L, M., Bontempi, Gianluca., Taillard, Eric., Romanego, Davide..(1996). Simulation and Forecasting in Intermodal Container Terminal. *Journal of Operational Research*.

Helmick, Jon S. (2001). Intermodal ports and liner shipping. *A 21st century status report*.

Hulter, Lars A.R. (1997). Container Logistics and its Management. *Ph.D study*. Report.32 Department of Transportation and Logistics, Göteborg., ES-IV-1 (Emprical Study of Container Logistics at Major Carriers, 1991)

Kutanoglu, Erhan., Cole, H, Michael. (2002). Empty Container Management for International Transportation Networks. *Journal of Shipping Management*.

Mat, Ramazan., Khalid, Husseyin.( 2000). Simulation and Analysis for the Kelang Container Terminal Operations. *Journal of Operational Research*.

Rizzoli, A.E., Mastrolilli, Gambradella, L, M., M., Zaffalon, M. (1999). Simulation for the Evaluation of Optimised Operations Policies in a Container Terminal. *Journal of Operational Research*.

Hassan, S, Ali. (1993). Port Activity Simulation: An Overview. *Journal of Operational Research*.

Harrison, P,Terry., Lee, L, Hau., Neale, J, John. (2003). The Practice of Supply Chain Management.

Ross, Frederick, David. (1998). *Competing Through Supply Chain Management*.

Sterman, John, D. (2000). *System Thinking and Modeling for a Complex World*: Iwrin MCGraw-Hill.



Stadler, Hartmut., Kilger, Christopher. (2005). *Supply Chain Management and Advanced Planning*.

Theofanis, Sotirios., Boile, Maria. (2007). Investigating the Feasibility of Establishing a Virtual Container Yard to Optimize Empty Container Movement in the NY-NJ Region. *Final Report*.

United Nations. (2005). Regional Shipping And Port Development Strategies (Container Traffic Forecast). *Research Document prepared with the support of U.N*  
[www.unescap.org/ttdw/Publications/TFS\\_pubs/pub\\_2398/pub\\_2398\\_fulltext.pdf](http://www.unescap.org/ttdw/Publications/TFS_pubs/pub_2398/pub_2398_fulltext.pdf)

Wei, Sun., Hoon, Sin, Hum. (2004). Container Deployment Problem. *Journal of Operational Research*.