

Tigrinya Applicatives
in
Lexical-Functional Grammar

Nazareth Amlesom Kifle

Dissertation presented in partial fulfilment
of the requirements for the degree philosophiae doctor (PhD)



Department of Linguistic, Literary and Aesthetic Studies
University of Bergen
2011

To the memory of my fallen brother
Abiel

Abstract

The primary goal of this thesis is to describe and analyze applicative constructions in Tigrinya. An applicative construction is characterized by a verb that bears an affix for an argument that either has a semantic role that is not normally entailed by the lexical meaning of the base verb or is specified as a peripheral argument. The choice of an applicative expression is motivated by semantic and discourse factors. Applicatively expressed arguments are associated with referents that possess high semantic prominence and discourse salience. The applicative phenomenon is viewed as a morphosyntactic strategy that introduces a core object function that is salient in the discourse event described by the verb. The theoretical motivation of this study is to explore the conditions that trigger object marking in Tigrinya so as to examine the semantic, functional and discourse properties of objects. The main theoretical framework used in this research is Lexical-Functional Grammar (LFG). This formalism assumes that the different linguistic information pertaining to functional, semantic and discourse structures can be modeled as interrelated parallel representations.

Formal syntactic theories classify applicative constructions into symmetrical and asymmetrical types according to the grammatical properties of objects coded in double object applicative clauses. Grammatical properties such as adjacency to the verb, pronominal marking and passivization are posited as parameters of object variation, and are assumed to be characteristic of the sole object of monotransitive clauses. In double object constructions object arguments that are implicated in these structures are regarded as possessing primary object properties. A theory of object asymmetries which predicts the patterns of objects across languages based

on applicative data predominantly from the Bantu languages assumes that in asymmetrical applicatives only one object argument, and most likely the applied object, displays primary object properties, whereas in symmetrical applicatives both object arguments, the base object of the verb and the applied object, display such properties (Bresnan and Moshi 1990, Alsina and Mchombo 1993). The object argument with primary object properties is assigned an OBJ grammatical function, and the argument object that lacks such traits is assigned an OBJ_θ grammatical function. The theory of object asymmetries is formulated within LMT, the sub-theory of LFG which deals with the mapping patterns of semantic arguments to grammatical functions. In this theory it is maintained that only one OBJ function can be realized in a clause, but there can be several restricted objects. Even though there can be two primary object arguments in symmetrical applicatives, only one of them can be analyzed as OBJ because this function must be unique in the clause. Due to this restriction, there is no difference in the analysis of object functions in asymmetrical and symmetrical applicative types; in both applicative types the two objects are analyzed as OBJ and OBJ_θ.

The Tigrinya data dealt with in this research indicate that the grammatical diagnostics that are posited to distinguish between symmetrical and asymmetrical objects do not converge into a single primary object property. In some double applicative constructions, objects reflect asymmetrical properties, and in others objects symmetrical properties. In asymmetrical applicatives the primary object properties are not correlated to differentiate between the applied and the base objects. With respect to some of the grammatical tests the applied object displays the opposite properties to what is predicted by LMT. Moreover, the Tigrinya data suggest that the classification of objects as OBJ and OBJ_θ cannot capture the similarity displayed by symmetrical objects. In Tigrinya, objects are coded in a complex interplay of word order, case marking and pronominal indexation which cannot be properly accounted for by the binary system proposed in LMT which assumes a straightforward contrast between objects. In this study we adopt the general constraint system in LFG in order to capture the different conditions on word order, case marking and pronominal indexation by which objects are distinguished. In addition, this research proposes that overt object coding cannot be regarded as a manifestation of primary objecthood in Tigrinya, since marked objects may or may not display genuine patient-like properties, but pronominally marked objects are all unified in their semantic and discourse properties.

Acknowledgements

ዝገበረልካስ ወይ ገበረሉ ወይ ንገረሉ ።

For those who have favored you,
either return the favor or tell others about it. (Tigrinya saying)

This thesis is the result of several years of research. The completion of it would not have been possible without the support and inspiration from many people who have been influential by directly contributing to my research or by providing me unfailing encouragement and love in my personal life. Though words fail me to express my gratitude to everyone, I still want to say THANK YOU!

I wish to express my gratitude to my advisor, Helge Dyvik, for his challenging and insightful comments on this thesis. I have learned a great deal of linguistics and grammar implementation skills from him. He has helped me to rectify linguistic blunders and imprecisions, and to correct grammar mistakes. I would like to thank him for all the assistance, whether academic, technical or administrative, he gave me during my period of research. Needless to say, all errors that remain in the text are my own.

This research has also benefited greatly from the discussions and comments from the members of my research group, LaMoRe. Especially, I consider myself very lucky for having been associated with Paul Meurer, Koenraad De Smedt and Victoria Rosén among my colleagues and friends. I would like to express my deep appreciation to Paul Meurer who has generously offered me his computational and linguistic expertise. My special thanks goes to Koenraad De Smedt and Victoria Rosén who since Day One of my arrival in Bergen have made sure that am com-

fortable in the research environment and in my adoptive country, Norway. They provided me with endless assistances wholeheartedly. I am very grateful to Koenraad De Smedt for introducing me to LaTeX, answering all my IT related questions promptly, editing various sections of the thesis, and for the supplies of exotic teas. I owe a special gratitude to Victoria Rosén for proofreading and commenting this thesis and thereby significantly improve the language and the presentation. I am also heartily thankful for her friendship and for being a constant source of motivation and support both in my personal and professional life.

I would also like to extend my appreciation to the members of the ParGram research group and the LFG community who on various occasions have offered me invaluable comments and feedback on different aspects of this work. I am particularly grateful for comments provided by Mary Dalrymple, Miriam Butt, Tracy Holloway King, Ron Kaplan, Yehuda Falk, Sam Mchombo and Anna Kibort. I am also grateful to Åshild Næss and Lars Hellan for commenting on some sections of this thesis.

I would like also to acknowledge the invaluable assistance from Tesfay Tewolde, whose linguistic expertise and enthusiasm for the Tigrinya grammar have greatly benefited this work. Our long email and telephone communications have helped me to deepen my knowledge of Tigrinya grammar. I am also grateful to Adi Ghebre, Chefena Hailemariam and John Abraha Ashkaba for their stimulating comments on the Tigrinya constructions in this work.

Further, I am sincerely grateful to the Ph.D. Research School in Linguistics and Philology at the University of Bergen, which has offered me opportunities to participate in seminars and to present my research. I would specially like to thank Jóhanna Barðdal, Kari Haugland, Kjersti Fløttum and Øivin Andersen for their constant encouragement and support.

I would like to recognize the financial support I have received from the Norwegian State Educational Loan Fund under the Quota Scheme and from the Department of Linguistic, Literary and Aesthetic Studies, University of Bergen. In this connection, I also would like to thank Sean O’Fahey, who through his connections at the Center for Development studies assisted me in finding placement in the Quota program. I also would like to extended my heartfelt gratitude to all my colleagues at the Section for Linguistics for providing me with the opportunity to take part in the teaching and research activities of the Section which was an extremely useful source of income and experience.

I wish to thank the library staff in the Social Sciences and Arts Library at the

University of Bergen, who I also had as colleagues when I worked as linguistics contact person for nine months last year. I would specially like to thank Maria-Carme Torras for encouraging me to send her my wish lists of important books for my research which were lacking from the library collections, which she promptly acquired and reserved them for my use. I am also grateful to Kari Normo for the wonderful services she offered me. She always made extra effort to track down and acquire from all over the world PhD monographs, journal articles and books which I desperately needed.

I am very grateful to Valerie Hannon Smitherman for helping me to edit and present my thesis more fluently and clearly. I would also like to thank Thomas Smitherman for facilitating the exchange of the material to be edited.

I owe an enormous debt of gratitude to all my special friends in Bergen and all over the world whose love and friendship has been a continuous source of motivation during this time. I treasure the times we spent together. Thank you for the coffee and lunch breaks, the cinema and concert tickets, the rendezvous in cafés and shops, the walks and hikes, the dinners with wines, cheeses and chocolates in the comfort of your homes, the encounters via email, Skype, telephone and Facebook, the holidays and vacations, the New Year, birthday, Easter, 17th of May, 24th of May, Eid ul-Fitr, Eid ul-Adha, Thanksgiving and Christmas celebrations we shared. I would specially like to thank Aasne Vikøy, Anders Gullestad, Else Ragni Yttredal, Gunn Inger Lyse, Jemila Seid, Maria-Carme Torras, Marco Gargiulo, Marie Skeie, Nazik Nurelhuda, Sølve Sætre, Shushan Berhe and Tsighe Siyum. Thank you for being a rock of support in the difficult times.

Last but certainly not least, I am grateful to my entire family: my parents, sisters, brothers, aunties, uncles, cousins, nieces and nephews, who have always been proud of my achievements. I miss all of you desperately as you also miss me, especially those of you whom I have not seen in the last eight years. I hope we will be reunited soon.

Praise be to God!

Abbreviations

1	1st person
2	2nd person
3	3rd person
ABL	ablative
ALL	allative
Appl	applicative
ben	beneficiary
Com	comitative
Caus	causative
Coord	coordination
dat	dative
Def	definite
Det	determiner
DT	detransitivizer
DistPro	distal demonstrative pronoun
DetPro	determinative pronoun
DetProx	proximal demonstrative
DetVoc	vocative determiner
Dir	directional preposition
Dist	distal demonstrative
F	feminine
Gen	genitive
H	honorific
Hort	hortative
Juss	jussive
IDcop	identity copula
Imperf	imperfective
Impr	imperative
Indef	indefinite

Infin	infinitive
Instr	instrumental
Loc	locative
Locop	locative copula
M	masculine
mal	malefactive semantic role
Neg	negative
Obj	objective case
Obl	oblique
OM ₁	affected object marker
OM ₂	non-affected object marker
Past	past tense
Perf	perfective
PerfH	perfective historic
PerfS	perfective simple
Pl	plural
Poss	possessive pronominal marker
POSS	possessive pronoun
Pres	present tense
Pro	pronominal affix
PRO	pronoun
PRORecip	reciprocal pronoun
PRORefl	reflexive pronoun
Prox	proximal demonstrative
ProxPro	proximal demonstrative pronoun
Purp	purposive
Recip	reciprocal
rec	recipient
Rel	relative
Refl	reflexive
SM	subject marker
Subjun	subjunctive
TA	tense aspect
th	theme
VN	verbal noun
VocDet	vocative determiner

Transliteration system

	ä	u	i	a	e	i	o		ä	u	i	a	e	i	o
h	ሀ	ሁ	ሂ	ሃ	ሄ	ህ	ሆ	ḥ	ዐ	ዑ	ዒ	ዓ	ዔ	ዕ	ዖ
l	ለ	ሉ	ሊ	ላ	ሌ	ል	ሎ	ẓ	ዘ	ዙ	ዚ	ዛ	ዜ	ዝ	ዞ
ḥ	ሐ	ሑ	ሒ	ሓ	ሔ	ሕ	ሖ	y	የ	ዩ	ይ	ያ	ዮ	ይ	ዮ
m	መ	ሙ	ሚ	ማ	ሚ	ም	ሞ	d	ደ	ዱ	ዲ	ዳ	ዴ	ድ	ዶ
r	ረ	ሩ	ሪ	ራ	ሬ	ር	ሮ	ḡ	ጀ	ጁ	ጂ	ጃ	ጄ	ጅ	ጆ
s	ሰ	ሱ	ሲ	ሳ	ሴ	ስ	ሶ	g	ገ	ጉ	ጊ	ጋ	ጌ	ግ	ገ
š	ሸ	ሹ	ሺ	ሻ	ሼ	ሽ	ሾ	t	ጠ	ጡ	ጢ	ጣ	ጤ	ጥ	ጦ
q	ቀ	ቁ	ቂ	ቃ	ቄ	ቅ	ቆ	č	ጨ	ጩ	ጪ	ጫ	ጬ	ጭ	ጮ
q̄	ቸ	ቹ	ቺ	ቻ	ቼ	ች	ቾ	p	ጸ	ጹ	ጺ	ጻ	ጼ	ጽ	ጾ
b	በ	ቡ	ቢ	ባ	ቤ	ብ	ቦ	ṣ	ጸ	ጹ	ጺ	ጻ	ጼ	ጽ	ጾ
v	ቨ	ቩ	ቪ	ቫ	ቬ	ቭ	ቮ	f	ፈ	ፉ	ፊ	ፋ	ፌ	ፍ	ፎ
t	ተ	ቱ	ቲ	ታ	ቲ	ት	ቸ	p	ፐ	ፑ	ፒ	ፓ	ፔ	ፕ	ፖ
č	ቸ	ቹ	ቺ	ቻ	ቼ	ች	ቾ	k ^w	ከ	-	ከ	ካ	ኪ	ከ	-
n	ነ	ኑ	ኒ	ና	ኔ	ን	ኖ	k̄ ^w	ኸ	-	ኸ	ኹ	ኸ	ኸ	-
ñ	ኸ	ኹ	ኺ	ኻ	ኼ	ኽ	ኾ	q ^w	ቄ	-	ቄ	ቅ	ቅ	ቄ	-
ʔ	አ	አ	አ	አ	አ	አ	አ	q̄ ^w	ቄ	-	ቄ	ቅ	ቅ	ቄ	-
k	ከ	ከ	ከ	ከ	ከ	ከ	ከ	g ^w	ጐ	-	ጐ	጑	጑	ጐ	-
k̄	ኸ	ኸ	ኸ	ኸ	ኸ	ኸ	ኸ								
w	ወ	ወ	ወ	ወ	ወ	ወ	ወ								

CONTENTS

Abstract	i
Acknowledgements	iii
Abbreviations	vii
Transliteration system	ix
I Preliminaries	1
1 Introduction	3
1.1 Theoretical motivation	3
1.2 Research questions	8
1.3 Thesis organization	13
2 The grammatical profile of Tigrinya	15
2.1 Introduction	15
2.2 Background	15
2.3 Nominals	18
2.3.1 Agreement	19
2.3.2 Pronouns	24
2.3.3 Determiners	27
2.3.4 Quantifiers	32

2.3.5	Possessive	33
2.3.6	Adjectives	37
2.3.7	Relatives	38
2.4	Verbals	39
2.4.1	Basic verbal inflection	40
2.4.2	Derived verbal roots	46
2.4.3	Copular derivation	49
2.4.4	Valence-changing morphology	52
2.5	Clause marking in Tigrinya	62
2.6	Concluding remarks	69
3	LFG basics	71
3.1	Introduction	71
3.2	C-structure	72
3.2.1	X' theory	75
3.2.2	Endocentric and exocentric categories	77
3.3	F-structure	78
3.3.1	Well-formedness conditions on f-structures	80
3.3.2	C-structure and f-structure correspondence	82
3.3.3	Grammatical functions	92
3.4	Discourse function representation	95
3.5	Summary	100
II	Applicative constructions	101
4	The applicative phenomenon	103
4.1	Introduction	103
4.2	The applicative operation	107
4.3	Applicative coding	111
4.4	Applied semantic roles	116
4.4.1	Recipient	118
4.4.2	Beneficiary, maleficiary and goal	119
4.4.3	Locative	122
4.4.4	Instrumental and path	125
4.4.5	Source	127
4.4.6	Experiencer	128

4.4.7	Possessor	133
4.5	Conclusion	134
5	Transitivity in applicative clauses	137
5.1	Introduction	137
5.2	Transitive vs. intransitive clauses	139
5.3	Applicative transitivity	142
5.3.1	Applicative transitivity in Tigrinya	147
5.3.2	Applicative formation and base verb transitivity	148
5.4	Concluding remarks	158
6	Applicative vs. oblique coding	159
6.1	Introduction	159
6.2	Oblique vs. adjunct distinction	160
6.3	Prepositional vs. applicative coding in Tigrinya	164
6.3.1	Directional <i>ni</i>	165
6.3.2	Beneficiary <i>ni, miʔinti and silä</i>	167
6.3.3	Purpose/reason <i>ni, miʔinti and silä</i>	170
6.3.4	Locative <i>ʔab</i>	174
6.3.5	Allative <i>nab</i>	177
6.3.6	Ablative <i>kab</i>	179
6.3.7	Instrumental <i>bi</i>	184
6.3.8	Topic/comment <i>bizaʕba</i>	188
6.3.9	Comitative <i>mis</i>	190
6.4	Primary applicative coding	191
6.4.1	Maleficiary	191
6.4.2	Possessor	192
6.4.3	Experiencer	193
6.5	Conclusion	194
III	Morphosyntactic and discourse approaches	195
7	Morphosyntactic approaches	197
7.1	Introduction	197
7.2	Morphosyntactic vs. morphosemantic operations	198
7.3	Relational grammar approach	201

7.4	Government and Binding approach	209
7.5	LFG's LMT approach to applicatives	218
7.5.1	Argument structure and thematic roles	219
7.5.2	A-structure to grammatical function mapping principles	226
7.5.3	Alternative mappings	228
7.6	Conclusion	236
8	Tigrinya objects and LMT	239
8.1	Introduction	239
8.2	Objecthood diagnostics	240
8.2.1	Word order, case marking and pronominal affixes	241
8.2.2	Passivization	260
8.2.3	Relativization	268
8.3	Which primary object property?	275
8.3.1	Affectedness of symmetrical objects	276
8.3.2	Affectedness of asymmetrical objects	282
8.3.3	Affectedness of monotransitive objects	286
8.3.4	Conclusion	288
8.4	Tigrinya applicatives according to LMT	290
8.4.1	Linking pattern in symmetric applicatives	290
8.4.2	Linking pattern in asymmetric applicatives in LMT	292
8.4.3	Linking pattern in applicatives of intransitive bases	294
8.5	Conclusions	299
9	Object topicality and DOM in Tigrinya	303
9.1	Introduction	303
9.2	Differential Object Marking	304
9.3	The function of DOM	307
9.3.1	Information structure roles: topic and focus	313
9.3.2	Verbal indexation: agreement vs. anaphoric marking	316
9.4	DOM and information structure roles	320
9.4.1	Alignment in monotransitive clauses	321
9.4.2	Alignment in ditransitive clauses	323
9.4.3	Alignment in applicatives of transitive bases	326
9.4.4	Alignment in intransitive applicatives	328
9.5	Conclusion	332

CONTENTS	xv
IV Implementation and conclusion	335
10 XLE implementation of Tigrinya	337
10.1 Introduction	337
10.2 Implementing an LFG grammar in XLE	338
10.2.1 CONFIG	340
10.2.2 RULES	341
10.2.3 LEXICON	342
10.2.4 TEMPLATES	343
10.2.5 Parsing	344
10.3 The nominal phrase in Tigrinya	346
10.4 The simple clause	353
10.5 The passive clause	361
10.6 Applicative clauses	362
10.6.1 Analysis of ditransitive clauses	363
10.6.2 Analysis of applied objects in transitive clauses	369
10.6.3 Analysis of applied objects in intransitive clauses	379
10.7 Conclusion	388
11 Conclusions	391

Part I

Preliminaries

CHAPTER 1

Introduction

1.1 Theoretical motivation

This thesis aims to describe and analyze the morphosyntactic and discourse properties of applicative constructions in Tigrinya. Pretheoretically, the applicative construction is a clause which involves a verb that bears a morphological affix for an object argument which normally is not among the verb's lexically entailed core arguments. To date, Tigrinya applicative constructions have not been investigated in any linguistic framework. The main theoretical approach used in this study is Lexical-Functional Grammar (LFG) even though the thesis will also make reference to research outside LFG that has made substantial contributions to the description and analysis of this phenomenon. In early studies, in approaches such as Relational Grammar (RG), Government and Binding (GB) and LFG, the applicative typology of the Bantu language family played a crucial role in the formulation of theories that predict the properties of applicatives across languages. Bantu applicatives were instrumental since these were the first to make their way into modern linguistic research, and they have thus popularized the phenomenon. In recent years, much research has discovered the phenomenon in a wide range of typologically and genetically diverse languages, and has observed applicative systems that diverge from the Bantu ones (Peterson 2007). The discovery of divergent applicative types warrants some revision of the existing theoretical models so that they can accommodate properties of the different systems.

position, applicative affix or prepositional marking – at their disposal to express peripheral semantic arguments.

In the standard terminological convention of applicative studies, the object that is initially subcategorized for by the verb is called the *base object* and the object that corresponds to the applicative morpheme is called the *applied object*. The base form of the verb is called the *base verb* and the verb that hosts the applicative morpheme is called the *applied verb*.

The morpholexical issue that applicative constructions display concerns the mapping pattern between semantic arguments and object functions. Semantic arguments represent the semantically entailed set of participants in an event described by a predicator/verb. These are often referred to by specific semantic role labels such as agent, patient, beneficiary and instrumental, etc. Grammatical functions are referred to as subject (SUBJ), object (OBJ), oblique (OBL). Double object applicative constructions as in (1) involve two object functions which are associated with a patient and an instrumental semantic role. Linguistic theories aim to characterize the syntactic categories of such objects and their linking pattern to semantic arguments based on certain grammatical properties. LFG assumes two types of object functions: primary object and secondary object, which are labeled as OBJ and OBJ_θ, respectively. LFG posits that only one OBJ function can be realized in a clause, but there may be more than one OBJ_θ function. Therefore, the puzzle that needs to be resolved in the applicative clause is to determine how semantic roles such as the theme/patient, the beneficiary and the instrumental are associated to object functions. For example, for the patient and the instrumental semantic roles in (1a), which of these four possibilities apply: does the patient link to OBJ or OBJ_θ, or does the instrumental link to OBJ or OBJ_θ?

A sub-theory within LFG known as the Lexical Mapping Theory (LMT) has been developed specifically to deal with such argument-function linking issues (Bresnan and Kanerva 1989). From its inception LMT was predominantly supported by extensive analysis of Bantu languages, and it is asserted to be generalizable cross-linguistically. LMT has been used by a huge body of research that aims to account for the functional category of objects and their linking patterns to semantic roles in double object and applicative constructions. Objects are assumed to be distinguishable by grammatical properties such as word order and pronominal indexation, on the one hand, and by the behavior they reflect when implicated in constructions such as the passive and relative clauses, among others, on the other hand. The ability of an object to appear in the verb-adjacent position in a clause,

to control a pronominal suffix and to function as a subject in passivization are assumed to be its primary objecthood properties. Alsina (1996:674) claims that these properties constitute a single underlying property of primary objects. In LMT this underlying primary objecthood property is formalized by the feature $[-r]$, which means semantically *unrestricted*. This feature classifies grammatical functions for their semantic versatility. OBJ is a $[-r]$ function, which means that arguments bearing any semantic role can fill this function. On the other hand, the lack of the primary objecthood property is formalized by the feature $[+r]$, which means semantically *restricted*. OBJ_{θ} is a $[+r]$ function, which means that only arguments with specific semantic role readings can fill this function. In addition, Bresnan and Kanerva (1989) propose that OBJ and OBJ_{θ} be classified as objective functions formalized by the feature $[+o]$. This feature marks objects for the complement role they play in transitive clauses.²

Bresnan and Moshi (1993) observe that Bantu languages are split into two types, symmetrical and asymmetrical object type languages. In the symmetrical object type languages both objects display primary object properties. In contrast, in the asymmetrical object type languages, only the applied object displays these properties. Bantu languages such as Chicheŵa (Baker 1990, Alsina and Mchombo 1993) and Kiswahili (Loogman 1965) are identified as asymmetrical applicative languages, whereas languages such as Kinyarwanda (Kimenyi 1980, Gary and Keenan 1977), Kichaga (Bresnan and Moshi 1990) and Bukusu (Peterson 2007:9) are identified as symmetrical applicative languages. Bresnan and Moshi (1990:171-172) propose a parameter of variation which they call the ‘‘Asymmetrical Object Parameter (AOP)’’ in order to account for the differences in the two applicative types. This parameter constrains the intrinsic classification of thematic roles by setting a condition that *only one semantic role* can be intrinsically specified as $[-r]$. This restriction is present in asymmetrical object type languages, but it is absent in symmetrical object type languages. What is regarded as a typical tendency is that in asymmetrical object languages only the applied semantic role can be intrinsically specified as $[-r]$, whereas the theme/patient semantic role receives the $[+o]$ specification which leads it to map onto the OBJ_{θ} function. On the other hand, since in symmetrical applicative languages the restriction given by the AOP is absent, the applied semantic role will always be specified as $[-r]$, but the theme/patient role can have the two

²Here we have only shown the feature decomposition system that applies to object functions. Subjects (SUBJ) and obliques (OBL) are also decomposed with respect to the features $[\pm r]$ and $[\pm o]$. A complete description which includes SUBJ and OBL will be presented in chapter 7.

alternative classifications [-r] or [+o]. Nevertheless, assigning the [-r] feature to both the applied role and the theme/patient role will violate an important condition, the well-formedness condition that LFG imposes on functional structure attributes such as SUBJ, OBJ and OBJ_θ. This condition demands that each lexically specified semantic role link to a unique grammatical function, and vice versa. This will rule out the presence of two OBJ functions in the same clause.

Applicative constructions in Tigrinya challenge some of the formulations of LMT that are concerned with object functions. Specifically, the pattern of object coding in Tigrinya challenges the feature decomposition system which is central in this theory. First, some of the grammatical properties which are assumed to compose “a single underlying property of internal arguments”³ (Alsina 1996:674), which dispose an argument to reflect primary object properties, do not converge to form a single feature (i.e. [-r]) in Tigrinya. Second, LMT does not properly account for the symmetrical properties of objects observed in applicative languages. In the analysis of Kichaga, a symmetrical applicative language, Bresnan and Moshi (1990:76) propose that the theme/patient argument will get different intrinsic classifications based on whether the applied verb is active or passive, which means the active and the passive variants of the same applied predicate have two different argument structures. In the argument structure of the active applied predicate the patient is assigned the [+o] feature, whereas in the argument structure of the passive applied predicate the patient/theme is assigned the [-r] feature. As argued by Kibort (2008), this conflicts with the explanation about the active-passive alternation maintained in LFG that the active and passive predicates must share the same argument structure (Bresnan 2001:26). Even so, Bresnan and Moshi assume that the variation between asymmetrical and symmetrical applicatives is attributed to the grammatical properties reflected by the object arguments involved, i.e. in the former type only one object argument possesses the properties expressed by the [-r] feature, whereas in the latter type two of the object arguments possess the properties expressed by [-r]. Nonetheless, for theory internal purposes the [-r] feature is rendered redundant by the alternative feature [+o] which is assigned to the patient/theme argument of the active predicate in an ad hoc fashion.

If in a given language object properties that are proposed to compose a primary object property [-r] do not converge, then we assume that these grammatical properties (e.g. pronominal indexation, case marking, word order vs. passivization) may be uncorrelated in that language. The problem of conflating grammatical properties

³Internal arguments are arguments that correspond to object functions.

such as word order and passivization as a test for grammatical function is discussed by Börjars and Vincent (2008), and they argue against the use of passivization as a diagnostic for grammatical functions in English. They maintain that in English dative-shifted double object constructions that involve a recipient/beneficiary and a theme argument, the beneficiary object is also restricted with respect to its semantic role reading, as is the theme. In current LMT, on the basis of passivizability the beneficiary is analyzed as unrestricted $[-r]$ and the theme as restricted $[+o]$, which leads them to be associated with OBJ and OBJ _{θ} , respectively. According to Börjars and Vincent the use of OBJ and OBJ _{θ} object classification in English ditransitive sentences does not capture the restrictedness of the beneficiary argument. We assume that symmetrical applicatives present the reverse of the problem noted by Börjars and Vincent (2008). In symmetrical applicatives the analysis of the theme object as OBJ _{θ} does not capture the nonrestrictedness $[-r]$ of this argument.

Based on these observations this thesis therefore aims to investigate the grammatical coding of objects and the grammatical properties they imply in Tigrinya. In addition, objects will be analyzed with respect to their involvement in construction types such as passive and relative clauses, and the type of object properties identified by these diagnostics will be examined.

1.2 Research questions

In the previous section we have outlined the problems with the formalization of object asymmetries in applicative constructions proposed by Bresnan and Moshi (1990). We have argued that the properties that are proposed to compose the unrestricted $[-r]$ feature do not converge to identify primary objecthood in Tigrinya. In this section we give an overview of the Tigrinya applicative data in order to show the pattern of object coding. We will provide a preliminary explanation for the motivations of the different coding strategies that interact in marking objects. In Tigrinya, object functions are coded in a complex interplay of word order, case marking and pronominal indexation. The different patterns that result from combinations of marked and/or unmarked objects identify object functions in double object constructions. Therefore, the properties for their identification must reflect these complexities, which currently are lacking in the binary feature decomposition method formalized in LMT. On the other hand, in Tigrinya only object arguments that are lexically entailed by the inherent meaning of a verb can undergo passivization. Even though non-core or peripheral arguments are allowed by virtue of the

applicative operation to be coded as core grammatical functions, they do not display the kind of semantic affectedness that core object arguments show. Based on this observation, we claim that pronominal marking and passivization indicate different grammatical properties of objects. This claim will be substantiated in the following.

In monotransitive clauses indefinite/nonspecific objects are unmarked (2a), while definite/specific objects are marked (2b). Marked objects involve the case marker *ni-* and pronominal object suffixes such as *-wa*, a suffix form glossed as *OM₁* in this work.

- (2) a. የኖስ መጽሐፍ ገዘኑ ።
 yonas mäṣḥaf gäzi-u
 Yonas.M book.Sg PerfS.buy-SM.3MSg
 ‘Yonas bought a book.’
- b. የኖስ ነታ መጽሐፍ ገዘኑዋ ።
 yonas n-äta mäṣḥaf gäzi?-u-wa
 Yonas.M Obj-Det.3FSg book.Sg PerfS.buy-SM.3MSg-OM₁.3FSg
 ‘Yonas bought the book.’

The phenomenon where objects with certain semantic features such as definiteness, animacy, humanness, etc. are coded differently than those objects which lack these properties is known as *Differential Object Marking* (DOM) (Bossong 1985, 1991). In Tigrinya object marking seems to be triggered by semantic features such as definiteness or specificity. In some languages the unmarked and marked objects may correlate with different object functions (Dalrymple and Nikolaeva 2011). However, in Tigrinya we do not assume that DOM induces changes in the grammatical function of object arguments. If this is the case, then pronominal indexation and case marking of objects have some other motivation than identifying the grammatical function of object arguments.

Based on this assumption, we argue that the criteria that are inducing DOM in monotransitive clauses are also inducing object marking in applicative clauses. In Tigrinya, intransitive (3a), transitive (3b) and ditransitive (3c) verbs allow applicative marking.

- (3) a. የኖስ ነታ ንል ጎዩዩዋ ።
 yonas n-ät-a g^wal g^wäyiy-u-wa
 Yonas.M Obj-Det-3FSg girl.FSg PerfS.run-SM.3MSg-OM₁.3FSg
 ‘Lit. Yonas ran after the girl./ Yonas chased the girl.’

- b. የኖስ ንሳባ መጽሐፍ ገዘኑላ ።
 yonas ni-Saba mäṣḥaf gäzi?-u-la
 Yonas.M Obj-Saba.F book.Sg PerfS.buy-SM.3MSg-OM₂.3FSg
 ‘Yonas bought Saba a book.’
- c. የኖስ ንሳባ መጽሐፍ ሂቡዋ ።
 yonas ni-Saba mäṣḥaf hib-u-wa
 Yonas.M Obj-Saba.F book.Sg PerfS.give-SM.3MSg-OM₁.3FSg
 ‘Yonas gave Saba a book.’

In (3a), the applied object *g^wal* ‘girl’ which is not initially entailed in the lexical meaning of the intransitive verb *g^wäyiy-u* ‘he ran’ is coreferenced on the verb by the object pronominal suffix *-wa* (OM₁) and the objective case *ni-*, similar to the definite object in monotransitive clause. Initially, this verb is subcategorized for an agent argument which corresponds to the subject Yonas. In (3b), the basic lexical meaning of the verb *gäzi?-u* ‘he bought’ only entails an agent and a theme argument which correspond to the subject Yonas and the object *mäṣḥaf* ‘book’, respectively. When the object pronominal suffix *-la*, which is a different form than *-wa*, is applied on the base verb, the verb acquires an applied object Saba which has a beneficiary semantic role. The applied object is also marked with the objective case *ni-*. In (3c), the ditransitive verb *hib-u-wa* ‘he gave her’ bears the object pronominal suffix *-wa*, the same suffix that is associated with the definite object of monotransitive verbs for the recipient object ‘Saba’. The objective case *ni-* is obligatory for recipient objects regardless of whether they are definite or not. The recipient and the beneficiary are identified with different object pronominal suffix forms – OM₁ and OM₂, respectively. The OM₁ and OM₂ indicate a difference in the transitivity property of verbs and the affectedness of objects.

The verb can only code one object at a time. When double object clauses involve two definite objects, the object that has greater discourse salience is prioritized for pronominal affixation. In (4) the object pronominal suffix corresponds to the theme object. With respect to pronominal marking, these objects are symmetrical.

(4) *definite theme object*

የኖስ ንግሉ ንወዲ ኅርኩ
 yonas ni-g^wal-u ni-wädi ሰርኩ
 Yonas.M Obj-daughter.FSg-Poss.3MSg Obj-son.MSg friend.Sg-Poss.3MSg
 ሂቡዋ ።
 hib-u-wa
 PerfS.give-SM.3MSg-OM₁.3FSg

‘Yonas gave his daughter to his friend’s son.’

In this discourse the theme object is more topical than the recipient object. In principle, either of the objects of ditransitive clauses can control verbal marking given that it is semantically prominent and salient in the discourse context. Based on the pattern of objects with respect to pronominal marking, we assume that this strategy does not code the grammatical function of objects, but their discourse status. Even though these objects are symmetrical, they can be distinguished by their word order. Definite theme objects must precede recipient objects. The order of objects becomes fixed when objects appear identical in their case marking. Otherwise, when their case marking pattern is different, the objects could switch position in order to render different pragmatic/discourse readings of the clause.

On the other hand, applicative clauses formed out of transitive verb bases involve asymmetrical objects. The applied object is obligatorily indexed on the verb. In (5a) the suffix OM₂ codes the locative argument *ṭawla* ‘table’, but when the verb codes the theme object *mäṣḥaf-u* ‘book’, the locative argument is expressed in a prepositional phrase (5b).

- (5) a. **ዮናስ ነታ ዘጽርኻያ ጣውላ**
 yonas n-ät-a zä-ṣrāk-a-ya ṭawla
 Yonas.M Obj-Det-3FSg Rel-PerfH.clean-SM.3MSg-OM₁.3FSg table.Sg
መጽሓፍ ኣንቢሩላ።
 mäṣḥaf-u ṗa-nbir-u-la
 book.Sg-Poss.3MSg Caus-PerfS.sit-SM.3MSg-OM₂.3FSg
 ‘Yonas put his book on the table that you cleaned.’
- b. **ዮናስ መጽሓፍ ኣብ’ታ**
 yonas mäṣḥaf-u ṗab-’t-a
 Yonas.M book.Sg-Poss.3MSg On-Det-3FSg
ዘጽርኻያ ጣውላ
 zä-ṣrāk-a-ya ṭawla
 Rel-PerfH.clean-SM.3MSg-OM₁.3MSg table.Sg
ኣንቢሩዎ።
 ṗa-nbir-u-wo
 Caus-PerfS.sit-SM.3MSg-OM₁.3MSg
 ‘Yonas put his book on the table that you cleaned.’

Objects in this applicative type reflect a different word order pattern from one which codes definite theme objects in ditransitive clauses. In applicative clauses that code locative, instrumental or source arguments, the applied object must precede a definite theme object. The tendency that discourse salient arguments are preposed on the left side of less salient arguments is quite prominent in Tigrinya syntax. Since this type of applicative clause cannot code double objects without the verb bearing a suffix for the applied object, the objects reflect an asymmetri-

cal property with respect to pronominal marking. The question is then, would the precedence for pronominal marking indicate that the applied object is the primary object in this applicative type? In our assumption, pronominal marking of applied objects indicates their core object status, but not a primary object property.

In passive clauses only the theme argument can link to the subject, but the applied argument may be indexed on the passive predicate (6a). The subject suffix cannot express an applied semantic role (6b). In contrast, in ditransitive clauses either the recipient (6c) or the theme (6d) argument can be associated with the subject in the passive.

- (6) a. ንሳባ መጽሐፍ ተገዘኡላ ።
 ni-saba mäṣḥaf tä-gäzi?-u-la
 Obj-Saba.F book.Sg DT-PerfS.buy-SM.3MSg-OM₂.3FSg
 ‘A book has been bought for Saba.’
- b. *ሳባ መጽሐፍ ተገዘኡ ።
 Saba mäṣḥaf tä-gäzi?-a
 Saba.F book.Sg DT-PerfS.buy-SM.3FSg
 ‘Saba has been bought a book.’
- c. ሳባ መጽሐፍ ተዋሂባ ።
 Saba mäṣḥaf tä-wahib-a
 Saba.F book.Sg DT-PerfS.give-SM.3FSg
 ‘Saba was given a book.’
- d. እቲ መጽሐፍ ንሳባ ተዋሂቡዋ ።
 ?it-i mäṣḥaf ni-Saba tä-wahib-u-wa
 Det.3MSg book.Sg Obj-Saba.F DT-PerfS.give-SM.3MSg-OM₁.3FSg
 ‘The book was given to Saba.’

Pronominal marking and passivization give uncorrelated results for applicative clauses formed out of transitive verb bases. According to the property indicated by pronominal marking, the applied object would be regarded as the primary object, but according to the property detected by passivization, the theme object would be regarded as the primary object. On the other hand, in ditransitive clauses both pronominal indexation and passivization indicate symmetrical properties of objects, thus both arguments would be regarded as having primary object properties.

The data presented indicate that Tigrinya applicatives cannot be properly accounted for by the formalization proposed in LMT. First, asymmetrical applicatives in this language suggest that pronominal marking and passivization cannot be conflated as a single property of primary objects. Second, the property of symmetrical objects in Tigrinya cannot be adequately captured by the binary feature decomposition method which due to the well-formedness conditions in LFG must

haphazardly change the unrestricted [-r] feature assigned to the theme/patient, and consequently, it violates the requirement for monotonic information resolution.

This study will closely examine the complex interplay of pronominal indexation, case marking and word order that distinguish between objects in Tigrinya clauses. We will investigate the alignment pattern of objects with regard to semantic roles, object functions and topicality.

The Tigrinya sentences used as data in this study are the author's own examples. However, they have been discussed with prominent Tigrinya linguists and with native speaker informants at various stages of the research.

1.3 Thesis organization

This thesis is divided into four parts. Part I contains three chapters, 1, 2 and 3, which are the preliminaries to this research. The present introduction constitutes chapter 1. Chapter 2 presents an overview discussion of Tigrinya grammar. The aim of this chapter is to give an introduction to the morphosyntax of nominal phrases and verbs, voice alternation constructions and clause marking in Tigrinya. Since little research has been done to describe Tigrinya syntax, this chapter will present original descriptive work that has been undertaken in this research. We also consider the content of this chapter as a reference for the implementation of the Tigrinya grammar which is presented in chapter 10. Chapter 3 introduces the LFG formalism. The aim of this chapter is to give basic information to readers who are unfamiliar with this framework. In addition, it serves as background reading to the LFG implementation part of the grammar.

Part II offers an extensive description of Tigrinya applicative constructions. This part consists of chapter 4, 5 and 6. Chapter 4 discusses the applicative phenomenon in Tigrinya, and gives some cross-linguistic comparison. The applicative construction is also examined in terms of the type of semantic roles it expresses, the type of markers it involves, and the nature of object affectedness coded by the two pronominal forms in Tigrinya. In chapter 5 we discuss the transitivity property of applicative constructions. The applicative is regarded as a transitivity inducing phenomenon. Here we investigate the nature of transitivity induced by attaching either of the pronominal suffix forms on different verb types. In chapter 6 we discuss the alternative prepositional coding of the applicatively expressed semantic roles. We examine the difference in discourse or pragmatic readings that the applicative and the prepositional expressions reflect. In Tigrinya some semantic roles can only be

expressed in an applicative construction, and some have distinct prepositions that restrict them to a specific semantic role reading.

Part III constitutes the analysis part of the thesis. It contains three chapters. Chapter 7 reviews the analyses of the applicative clauses in three different generative grammar approaches: Relational Grammar, Government and Binding, and Lexical-Functional grammar. The chapter discusses in detail Lexical Mapping Theory since it is this approach that we aim to assess in this study. In chapter 8 we discuss object properties in Tigrinya and their implications for the primary object properties assumed in LMT. The chapter offers a functional motivation for marking objects. Chapter 9 discusses differential object marking and its function as a topic object marker.

Part IV consists of two chapters that tie together the different issues raised in this work. Chapter 10 presents the implementation of Tigrinya grammar on the XLE platform, which is a linguistic environment for the computational implementation of LFG grammars. We show the LFG analysis of nominal phrases, simple clauses, and lexical rules such as the passive. In addition, we integrate the analysis of ditransitive and applicative constructions formed out of transitive and intransitive verb bases in the general grammar of Tigrinya. Currently, due to time constraints the discourse function of objects has not been implemented. Finally, chapter 11 concludes the thesis. It presents the general conclusion of the whole thesis, and offers concluding remarks for each chapter. We also outline some limitations, and some ideas for possible future research.

CHAPTER 2

The grammatical profile of Tigrinya

2.1 Introduction

The aim of this chapter is to outline some of the salient properties of the morphology and syntax of Tigrinya. This we hope will give a wider picture of the language so as to place the description and analysis of the applicative constructions undertaken in this study in perspective. General information about the grammar of Tigrinya can be found in Leslau (1941), Masson (1994), Kogan (1997), Mulugeta (2001) and Tesfay (2002).

This chapter is organized as follows. First, in section 2.2 the linguistic classification and typological features of the language will be presented briefly. Second, in sections 2.3 and 2.4 the basic structure of nominals and verbs will be described, respectively. Finally, the structure of the Tigrinya clause and the strategies of coding grammatical function in terms of word order, case marking and pronominal indexation will be outlined in section 2.5.

2.2 Background

Tigrinya is one of the Ethio-Eritrean Semitic languages, a sub-family of South Semitic languages.¹ The Ethio-Eritrean Semitic languages are further divided

¹In this work we adopt the name Ethio-Eritrean Semitic languages in order to embrace the change in the geopolitical map of the region. After Ferguson (1970), the Semitic languages of Eritrea and

into two sub-groups: North Ethiopian and Eritrean Semitic languages, and South Ethiopian Semitic languages. The former comprises Ge'ez, Tigré and Tigrinya.² Ge'ez and Tigrinya are common to both Eritrea and Ethiopia, but Tigré is spoken only in Eritrea. South Ethiopian Semitic languages include Amharic as well as over 20 other languages.

The majority of Tigrinya speakers are found in Northern Ethiopia in a region called Tigray where it is the administrative language. According to the census of 2008 conducted by the Central Statistical Authority of Ethiopia³, the number of Tigrinya speakers in Ethiopia is about 4.48 million. Tigrinya is also the mother tongue of the Tigrinya ethnic group who mainly inhabit the highlands of Eritrea. The number of Tigrinya speakers in Eritrea is estimated to be 2.54 million according to the census of 2006 quoted by (Lewis 2009). In both countries there are about 6.9 million Tigrinya speakers (Voigt 2009). Tigrinya serves as the official language of the state of Eritrea along with Arabic. There are many regional varieties within the Tigrinya spoken in Eritrea and that spoken in Ethiopia. However, as no dialectal research has been conducted, it is difficult to say how distant the dialects are from each other. Nevertheless, it is generally held that the different regional varieties are mutually intelligible (Tesfay 2002, Mulugeta 2001). The data dealt with in this study mainly reflect the standard variety found in Eritrea.

Tigrinya preserves several Proto-Semitic traits in its morphology, syntax and vocabulary. It is characterized by the Semitic root-pattern morphology where predominantly triconsonantal roots, which represent the semantic core of a stem, combine with vocalic templates to derive various inflectional and derivational forms. In addition, Tigrinya exhibits a typical Semitic phenomenon known as broken plurals with some of its nouns ((Palmer 1955), see also section 2.3.1). Moreover, Tigrinya determiners (e.g. *ʔi-t-* 'the/that') and demonstratives (e.g. *ʔi-z-* 'this') have cognates in many Semitic languages (e.g. Hebrew and Phoenician (Lipiński 1997:320-

Ethiopia have been conventionally classified as Ethiopian Semitic or Ethio-Semitic languages in most academic circles. This classification was based on the geopolitical context when Eritrea was considered as a region in Ethiopia. However, since now Eritrea is an independent country, the classification cannot reflect the current context. For instance, the fact that Tigrinya and Ge'ez, which are classified as North Ethiopian Semitic languages, are common to both countries and Tigré is found only in Eritrea is not properly covered by the old classification. A similar concern is also expressed by Tosco (2000).

²Ge'ez, Tigré and Tigrinya are alternatively spelled as Gi'iz, Tigre and Tigrigna in some scholarly work. In the native script these are written as ግዕዝ *gi'iz*, ትግረ *tigrä* and ትግርይና *tigrinya* or ትግርኛ *tigriña*, respectively.

³http://www.csa.gov.et/pdf/Cen2007_first-draft.pdf

321)). The Proto-Semitic feminine marker *-t* is also used with some nouns and adjectives (e.g. ሰብአይ *säbʔay* ‘man’ vs. ሰበይቲ *säbäy-ti* ‘woman’, ንጉስ *nigus* ‘king’ vs. ንግስቲ *nigis-ti* ‘queen’ and ጽቡቕ *ṣibuq̄* vs. ‘good.M’ ጽቡቕቲ *ṣibiq̄-ti* ‘good-F’). Verbs bear obligatory subject affixes which express person, gender, and number agreement. Moreover, it is widely observed in Semitic languages that objects which correspond to semantically prominent or discourse salient referents trigger case marking and/or pronominal indexation (Khan 1984). In Tigrinya most of the subject and object affixes have Semitic cognates (Lipiński 1997:307). The object pronominal suffix that is employed to code beneficiary, locative or instrumental object arguments contains the prepositional particle *-l-* which in most Semitic languages is a dative preposition.

Semitic typologists deduce that initially the syntax of the modern Ethio-Eritrean Semitic languages reflected a typical Semitic structure with a verb-initial clause (VSO), auxiliaries preceding main verbs and relative clauses following head nouns, before they came in contact with Cushitic languages, specifically with Bedja and Agew (Leslau 1945, 1952, Hetzron 1975, Thomason 2001, Tosco 2000). Now the modern Ethio-Eritrean Semitic languages employ a verb-final clause structure (SOV). Geʿez instead remained stable since it still retains a verb-initial clause structure, and also exhibits verbless or null copula predicative clauses like most of its Semitic peers (Lipiński 1997, Gragg 1997, Hetzron 1975:488).⁴ Cushitic syntax also had influence on the nominal phrases of these languages. Prototypical Semitic modifiers such as adjectives generally follow their heads, consistent with their head-initial syntactic structure; however, in Tigrinya modifiers precede the head nouns. The existence of converb constructions in the modern Ethio-Eritrean Semitic languages is also attributed to Cushitic influence (Azeb and Dimmendaal 2006:409) (see page 43 for a description of the converb construction).

Tigrinya is written with the Geʿez script. Geʿez is a syllabic writing system where consonant and vowel phonemes are combined in a single glyph known as ፊደል *fidēl*, i.e. a syllograph. A syllograph has seven different forms, traditionally known as orders/series. These are identified with seven signatures that represent vocalic phonemes, as is shown in Table 2.1 below.

For example, ሰ is a combination of *b* and *ä*, and ከ is a combination of the glottal stop *ʔ* and *ä*. The diacritic convention adopted in this work is the standard

⁴Geʿez does not have living speakers any longer. It exists as a liturgical language of the Orthodox and the Catholic churches in Eritrea and Ethiopia. It had ceased to function as a spoken language as early as the 9th century A.D.

The general linear order of elements in the nominal phrase is shown in (8) below.⁵

- (8) (Qall) (Det) (RelP) (POSS/PP_{poss}) (Q) (Adj) N

As the nominal phrase in (7) shows, Tigrinya employs complex morphology. Generally, nouns inflect for plural number. However, except for some, nouns are not overtly marked for gender. Gender is marked via specifiers, modifiers and verb inflections. Quantifiers and determiners inflect for number, gender and person. Adjectives inflect for number and gender. Personal and possessive pronouns show detailed number, gender and person agreement features. The different specifiers and modifiers must agree with each other and with the head noun. Below we will provide a brief account of the agreement pattern in the nominal phrase.

2.3.1 Agreement

The specifiers and modifiers such as quantifiers, determiners, adjectives and relatives agree in number and gender with the head noun. Tigrinya has a singular/plural number system, and a masculine/feminine gender system. In addition pronouns reveal extensive conjugation paradigms along the gender, number and person dimensions.

Number

The basic form of a noun serves as its singular form, while the plural form is inflected. Most nouns employ the regular (external) plural formation strategy by adding the suffix *-at* or *-tat* – depending on whether a noun ends with a consonant (9a, 9b) or a vowel (9c, 9d).

- | | | | | |
|-----|----|---|----|---|
| (9) | a. | ሰብ > ሰባት
säb > säb-at
person.Sg > person-Pl | c. | አደ > አደታት
ʔaddä > ʔaddä-tat
mother.Sg > mother-Pl |
| | b. | ሕጻን > ሕጻናት
ḥiṣan > ḥiṣan-at
baby.Sg > baby-Pl | d. | አቦ > አቦታት
ʔabbo > ʔabbo-tat
father.Sg > father-Pl |

Some nouns employ the so-called adjective plural suffix *-ti* or its variant *-wti* to inflect for plural. This is known as adjective suffix since it is very common with

⁵The round brackets enclosing the category labels such as the quantifier ‘all’ (Qall), determiner (Det), relative phrase (RelP), etc. indicate optionality.

plural inflection of adjectival nouns.⁶ The suffix *-ti* is used when a noun ends with a consonant (10a, 10b), whereas *-wti* is used when a noun ends with a vowel (10c, 10d).

- | | | |
|------|---|---|
| (10) | <p>a. መጽሐፍ > መጽሐፍቲ
mäṣṣḥaf > mäṣṣḥaf-ti
book.Sg > book-Pl</p> <p>b. ጽሓፊ/-ት > ጽሓፍቲ
ṣḥaf-i/-t > ṣḥaf-ti
writer-M/-F > writer-Pl</p> | <p>c. ገዛ > ገዛውቲ
gäza > gäza-wti
house.Sg > house-Pl</p> <p>d. መርዓዊ/ት > መርዓውቲ
märʾa-wi/-t > märʾa-wti
wedded-M/-F > wedded-Pl
'bride/groom' > 'bride and groom'</p> |
|------|---|---|

Tigrinya also has a considerable number of nouns that exhibit the Semitic phenomenon known as the 'broken plural' or internal system (Palmer 1955). This strategy is characterized by a systematic change in the pattern of vocalic templates which may also involve the deletion or insertion of some consonantal roots, and the addition of affixes, as illustrated in (11).

- | | | |
|------|--|--|
| (11) | <p>a. ኮከብ > ከዋክብቲ
koḵäb > käwäḵib-ti
book.Sg > book-Pl</p> <p>b. ኢድ > ኢድዓው
ʾid > ʾa-ʾid-aw
hand.Sg > hand-Pl</p> | <p>c. ወኻርያ > ወኻሩ
wäḵarya > wäḵaru
fox.Sg > fox.Pl</p> <p>d. ሓርማዝ > ሓራምዝ
ḥarmaz > ḥaramiz
elephant.Sg > elephant.Pl</p> |
|------|--|--|

For example, the plural noun in (11a) involves a pattern change (i.e. the first *ko* becomes *kä* and the second *kä* becomes *ḵi*), an infix (*w-*) and the adjective plural suffix (*-ti*). Similarly, the plural noun (11b) bears a prefix (*ʾa-*) and a suffix (*w*), and the vocalic patterns of the consonantal roots *ʾd* are also changed from *ʾid* to *ʾida*. In example (11c), the plural noun shows both pattern change and deletion. The consonantal root and its pattern *ya* are deleted, and the final consonantal root in the resulting radicals acquires a new pattern *r-u*.⁷ In example (11d) the vocalic templates that are associated with *-r-m-* are changed from *-rma-* to *-rami-*.

⁶The first *-t-* in *-tat* and *-w-* in *-wti-* are some of the hiatus consonants that appear in various phonological environments in order to regulate the syllabic structure of a word when affixes are added to it. For example, *-t-* is inserted in order to prevent a vowel sequence within the same syllable (e.g. *-ä-at* and *-o-at* in (9a) and (9b), respectively). Similarly, the glide consonant *-w-* is inserted between the noun stem and the plural suffix *-ti* when a noun ends with a vowel. However, the plural suffixes are directly attached to nouns that end with consonants.

⁷The final vocalic pattern *-u* is a productive internal structure of some broken plural forms. For example, it appears with plural form of ደርሆ *därho* 'hen' ደራሁ *därah-u* 'hens, chicken', ዕዋላ *ʾiwala*

Plural forms of inanimate nouns can agree with singular masculine specifier, modifier or verb forms in order to render a collective reading. However, the feminine forms of specifiers and modifiers cannot be used in the same way. Since plural forms of adjectives are not specified for gender, both the singular masculine and the plural forms can be used to modifier inanimate plural nouns, as in (12a).

- (12) a. እቲ ካዲሽ/ ካዲሽቲ መጽሐፍቲ ኩሉ ጠፊኡ።
 ?it-i hədiš/ hədäšti mäşḥaf-ti kul-u tǎfi?-u
 Det-3MSg new.MSg/ new.Pl book-Pl All-M Perf-lose-SM.3MSg
 ‘All the new books got lost.’
- b. *እታ መጽሐፍቲ ኩላ ጠፊኣ።
 ?it-a mäşḥaf-ti kul-a tǎfi?-a
 Det-3FSg book-Pl All-F Perf-lose-SM.3FSg
- c. እተን ካዲሽቲ መጽሐፍቲ ኩለን ጠፊኡን።
 ?it-än hədäšti mäşḥaf-ti kul-än tǎfi?-än
 Det-3FPI new.Pl book-Pl All-PIF Perf-lose-SM.3FPI
 ‘All the new books got lost.’

In contrast, it is ungrammatical to use the feminine form of the determiner in the same way (12b). Nouns that are assigned the feminine gender are perceived as individuated entities. Thus, when a plural noun is assigned a feminine gender, then the plural agreement value is obligatorily distributed in all the associated elements such as determiners, adjectives and verbal affixes. In this sense, there is an obligatory concord between determiners, modifiers and verbs (12c). Similarly, there is an obligatory number and gender concord in a nominal phrase with animate noun referents, as in (13a).

- (13) a. እቲ ጸለም/ እታ ጸለም ድሙ/*ደማሙ
 ?it-i şälim/ ?it-a şälam dimmu/dämamu
 Det-3MSg black.M/ Det-3FSg black.F cat.Sg/cat.Pl
 ‘the(M)/ the black cat’
- b. እቶም/ እተን ጸለምቲ ደማሙ
 ?it-om/ ?it-än şäläm-ti dämamu
 Det-3MPl/ Det-3FPI black-Pl cat.Pl
 ‘the(MPl)/ the(FPl) black cats’

In (13b) only the singular noun form is grammatical. In addition, as in (13b), distributing the plural agreement to the determiner is grammatical since the head noun has an animate referent.

‘delinquent’ ዓዋሉ sawal-u ‘delinquents’, ጭሩ çiru ‘bird’ ጨራሩ çärar-u ‘birds’ and ቁልዓ q^wälſa ‘child’ ቁልዑ q^wälſ-u ‘children’.

Gender

Nouns in Tigrinya are assigned to either of the two grammatical gender categories: masculine or feminine. Gender is fully expressed in the pronoun system of the language (2.3.2). Common nouns do not normally inflect for gender, except for a few that are cross-classified as adjectives or nouns, and thus employ the adjectival gender inflection form. For example, *-y* in **ተመሃራይ** *tämähara-y* ‘student-M’ and **ሕጹይ** *hiṣu-y* ‘fiancé/candidate-M’ and *-wi* in **መርዓዊ** *märṣa-wi* ‘groom’ mark a masculine gender, whereas *-t* in **ተመሃራት** *tämähari-t* ‘student-F’, **ሕጹይቲ** *hiṣ-iy-ti* ‘fiancé/candidate-F’ and **መርዓት** *märṣa-t* ‘bride’ mark a feminine gender. However, not all adjectival nouns are inflected for gender. For example, **መምህር** *mämhir* ‘teacher’, **ሓኪም** *hakim* ‘doctor/healer’, **ወተሃደር** *wätähader* ‘soldier’ can be employed for either male or female referents.

In Tigrinya only some nouns that denote biological sex distinctions have pre-determined gender values, for example, **ወዲ** *wäddi* ‘boy’, **ጎል** *g^wal* ‘girl’, **ላም** *lam* ‘cow’ and **ብዕራይ** *biṣray* ‘bovine male’. In contrast, nouns with animate referents that do not make a sex distinction, for example, **ሕጻን** *hiṣan* ‘baby/child’, **ዕየት** *ṣiyät* ‘lamb’, **ክልቢ** *kälbi* ‘dog’ and **ድሙ** *dimmu* ‘cat’ etc, are assigned a default masculine gender when they are used in generic statements (14a) and (14b) and when they refer to a mixed group in the plural form (14c).

- (14) a. **ክልቢ እሙን እንስሳ እዩ ።**
kälbi ṣimun ṣinsisa ṣiyy-u
 dog.Sg loyal.MSg animal Pres.IDcop.be-SM.3MSg
 ‘(A) dog is a loyal animal.’
- b. **ሕጻናት ብዙሕ ክንክን ይደልዩ ።**
hiṣan-at bizuh kinkin yi-däliyy-u
 baby-Pl lots-of care Imperf.3-need-SM.MPI
 ‘Babies need a lot of care.’
- c. **እቶም ዕያውቲ ተባዕትዮ ጥራሕ ኣይኮነን ።**
ṣit-om ṣiyawi-ti täbaṣit-yo ṣirah ṣay-kon-u-n
 Det-3MPI lamb-Pl male-Pl only Neg-Pres.be-SM.3MPI-Neg
 ‘The lambs are not only males.’

In these examples *kälbi* ‘dog’, *hiṣan-at* ‘babies’ and *ṣiyawi-ti* ‘lambs’ can only be specified as masculine, and a feminine specification would make the constructions ungrammatical. Gender-inflected adjectives or determiners are used when nouns are employed to denote a male or a female referent. For example, in (15) the gender value of the noun is expressed through adjectives.

- (15) ተባዕታይ/ ኣንስተይቲ ድመ
 tābaʿitay/ ʔanistä-ti dimmu
 male/ female cat.Sg
 ‘male/female cat’

For this reason, Tigrinya is said to have a grammatical gender where a noun can be assigned masculine or feminine gender invariably. Animate entities such as ኣባጊዕ *ʔabagiʿi* ‘sheep/flock of sheep’, ደርሁ *därhu* ‘chicken/hens’, ኣዕዋፍ *ʔaʿiwaf* ‘birds’ and ከብቲ *käbti* ‘cattle’ are specified as feminine when they refer to a herd or a flock consisting of both male and female members. The feminine gender assignment for such nouns appears to deviate from the default gender norm, i.e. the masculine. This convention may be rooted in the farming tradition of Tigrinya society where farmers keep mostly female sheep, goats, cattle, chickens etc. in their herd or flock, whereas they keep only a few males for breeding purposes. Thus, since the female members of the herd or flock constitute the majority, nouns that denote such practices are classified as feminine.

Gender assignment in nouns that denote inanimate entities is either utterly arbitrary or at least quite flexible. Tigrinya has few nouns that refer to unique entities that have predictable grammatical gender; for example, ጽሓይ *ṣihay* ‘sun.F’, ወርሂ *wärhi* ‘moon.F’, ምድሪ *midri* ‘earth.F’, ሰማይ *sämay* ‘sky/heaven.M’, ጠፈር *ṭäfar* ‘cosmos.M’. Gender assignment for such categories seem to be based on their semantic properties. Elements perceived as contained or having a definite shape are assigned feminine gender, whereas elements that have a property of vastness or fluidity are assigned masculine gender. Nouns that refer to concrete entities can be freely used as either masculine or feminine. For example, ኢት/ኢታ መጽሓፍ *ʔit-i/ʔit-a mäṣṣhaf* ‘the-3MSg/3FSg book’, ኢት/ ኢታ ገዛ *ʔit-i/ʔit-a gäza* ‘the-3MSg/3FSg house’, ኢት/ኢታ መርፍእ *ʔit-i/ʔit-a märʿäʔ* ‘the-3MSg/3FSg needle’ and ኢት/ኢታ ገቦ *ʔit-i/ʔit-a gobo* ‘the-3MSg/3FSg mountain’.

In general, the alternative assignment of masculine or feminine gender does not bring about a major difference in meaning. However, in some contexts gender assignment may have a pragmatic function. For example, masculine gender may express that something is unexpectedly or undesirably large, thus having a derogatory connotation, and the feminine gender may express that the noun referent is unexpectedly small with a diminutive or affectionate connotation. For more information on the assignment of gender in Tigrinya see Brindle (2005, 2006).

2.3.2 Pronouns

Tigrinya has subject and object pronoun forms. The pronoun system reflects exhaustive number, gender and person agreement values. Both subject and object pronoun stems are marked with similar pronominal suffix forms that are distinct for the gender, number and person combination they mark. The subjective and the objective pronouns are listed in Table 2.2.

Subjective personal pronouns	Objective personal pronouns	Agreement
ንሱ niss-u	ንዓኡ (ንኣኡ) niʔaʔ-u (niʔaʔ-u)	3MSg
ንሳ niss-a	ንዓኣ (ንኣኣ) niʔaʔ-a (niʔaʔ-a)	3SgF
ንሶም niss-om	ንዓኦም (ንኣኦም) niʔaʔ-om (niʔaʔ-om)	3MH
ንሰን niss-än	ንዓኣን (ንኣኣን) niʔaʔ-än (niʔaʔ-än)	3FH
ንሳተም nissa-tom	ንዓኣተም (ንኣኣተም) niʔaʔa-tom (niʔaʔa-tom)	3MPI
ንሳተን nissa-tän	ንዓኣተን (ንኣኣተን) niʔaʔ-tän (niʔaʔ-tän)	3FPI
ንሰኻ nissi-ka	ንዓኻ (ንኣኻ) niʔa-ka (niʔa-ka)	2MSg
ንሰኺ nissi-ki	ንዓኺ (ንኣኺ) niʔa-ki (niʔa-ki)	2FSg
ንሰኹም nissi-kum	ንዓኹም (ንኣኹም) niʔa-kum (niʔa-kum)	2M[PI/H]
ንሰኽን nissi-kin	ንዓኽን (ንኣኽን) niʔa-kin (niʔa-kin)	2F[PI/H]
ንሰኻትኩም nissi-kaatkum	ንዓኻትኩም (ንኣኻትኩም) niʔa-kaatkum (niʔa-kaatkum)	2MPI
ንሰኻትክን nissi-kaatkin	ንዓኻትክን (ንኣኻትክን) niʔa-kaatkin (niʔa-kaatkin)	2FPI
ኣነ ʔan-ä	ንዓይ (ንኣይ) niʔa-yi (niʔa-yi)	1Sg
ንሕና nih-na	ንዓና (ንኣና) niʔa-na (niʔa-na)	1Pl

Table 2.2: Tigrinya subjective and objective personal pronouns

In Tigrinya overt pronouns do not normally occur as anaphors, i.e. as co-referents of nominal arguments that are mentioned in the preceding discourse. Since Tigrinya is a pro-drop language, when there is no overt pronoun, verbal pronominal affixes have anaphoric function. Subjects are obligatorily marked through verbal affixes. Definite and referential objects are also indexed on the verb through object suffixes. The following example illustrates the role of pronominal markers in discourse (16).⁸

⁸This excerpt is taken from the Tigrinya translation of Jostein Gaarder's (1991) novel *Sofies verden*

- (16) a. ሶቅራጠስ እዚ ምስ ነገሩዎ ብስምዓዊ
 soqiratäs ?iz-i mis nägär-u-wo bi-simbadä
 Socrates DetProx-3MSg when told-SM.3MPI-OM₁.3MSg by-shock
 ደረቆ፡ ተገረመ ከአ፡፡
 dārāq-ä፡ tä-gäräm-ä kääʔa
 became=rigid-SM.3MSg DT-Per.be=surprised-SM.3MSg also
 ‘Socrates was paralyzed from shock and was astonished when they told him this.’
- b. ብድሕሪኡ ሓሲቡ ሓሲቡ፡ ናብ ሓደ
 bi-dihiri-ʔu hasib-u hasib-u፡ nab had-ä
 Instr-behind-3MSg thought-SM.3MSg thought-SM.3MSg to one-M
 ካልእ ኩሉ ህዝቢ ኣተነ፡ ዋላ ሶቅራጠስ ባዕሉ ለባም
 kaliʔ kul-u hizbi ʔatänä wala soqratäs baʕl-u läbam
 another all-M people Athens even Socrates self-3MSg wise
 እዩ ዝበሎ ሰብ
 ʔiyy-u zi-bäl-o säb
 Pres.IDcop.be.3MSg that-call.SM.3MSg-OM₁.3MSg person
 ከይዱ ሕቶታት ሓተቶ፡፡
 käyd-u hito-tat hatät-o
 went-SM.3MSg question-Pl asked.SM.3MSg-OM₁.3MSg
 ‘After that, he thought hard, and he went to another person who all people of Athens and Socrates himself say is wise and asked him questions.’

For example, in (16a) the verb of the adverbial subordinate clause, *nägär-u-wo* ‘told-SM.3MSg-OM₁.3MPI’, bears subject and object suffixes juxtaposed one after another. The subject suffix corresponds to the referent which is not overtly realized in the clause; however, it can be traced from the previous discourse. Thus, the Tigrinya subject pronominal suffix has the same function as the translationally equivalent pronoun *they* in English. The object pronominal suffix corresponds to the subject of the main clause *Socrates*. Similarly, the subject marker on the conjoined verb *tä-gäräm-ä* ‘be=surprised.SM.3MSg’ does not have an overtly realized referent within the conjoined clause, but it refers back to the subject of the first part of the conjoined clause. In (16b) the referent of the subject argument is not realized in the same clause, thus the subject suffixes in *hasib-u hasib-u* ‘thought-SM.3MSg thought-SM.3MSg’⁹, *käydu* ‘went-SM.3MSg’ and *hatät-o* ‘asked.SM.3MSg-OM₁.3MSg’ have anaphoric function since they correspond to a referent of the subject ‘Socrates’ mentioned in the preceding discourse.

‘Sophie’s World’.

⁹In Tigrinya repetition of words marks recurrence and intensification. In *hasib-u hasib-u* the word is repeated in order to intensify the meaning of the verb. This strategy is also common with time expressions such as ሙዓልቲ ሙዓልቲ *mäʕalti mäʕalti* ‘every day’ and ዓመት ዓመት *ʕamät ʕamät* ‘every year’ to express reoccurrence.

the plural form since it can only have plural referents. Like the reflexive forms, its object function is indicated by the case prefix *ni-*. The examples in (18) illustrate the uses of reciprocal pronouns.

- (18) a. ናይ ሓድሕድ ሓልዮት ኣድላዩ እዩ ።
 nay ḥadḥid ḥalyot ?adlay-i ?iyy-u
 Gen PRORecip care important-M Pres.IDcop.be-SM.3MSg
 ‘The care of each other is important.’
- b. እቶም ኣሕዋት ንኣድሕዶም ተሓላፊዮም ።
 ?it-om ?aḥwat ni-ḥadḥid-om tā-ḥalaliy-om
 Det.3MPI brother.Pl Obj-PRORecip-3MPI TM-Recip=PerfS.care-SM.3MPI
 ‘The siblings cared for each other.’

The unmarked form *ḥadḥid* in (18a) does not have an anaphoric function since it is employed as a regular noun to modify another noun. On the other hand, in (18b) *ni-ḥadḥid-om* has an anaphoric function, and thus is a reciprocal pronoun. It serves as an object argument that has the subject as its reciprocating mate.

2.3.3 Determiners

Grammatical elements such as articles, demonstratives, quantifiers and numerals can be grouped together as determiners. Determiners specify nouns in terms of their referential status. One of their functions is to supply features of definiteness and indefiniteness to nouns. For example, definite articles express the presupposition that the hearer or the addressee is familiar with or can identify the referent of the noun that is being determined. Based on these grammatical properties, determiners are identified as functional elements, as opposed to lexical elements. Languages may differ in the classification of functional words. Certain elements that belong to the determiner category in one language, may correspond to elements that are classified as modifiers in another. A phrase that consists of a determiner and its complement is identified as a determiner phrase (DP) in modern syntactic theories such as LFG. The determiner plays the role of a functional head in this phrase, and it takes an optional nominal complement. In this section we will illustrate the general structure of determiner phrases in Tigrinya.

Tigrinya does not have separate classes of definite articles and demonstratives. There is only one form that serves both functions. According to Lyons (1999:18), definite articles and demonstratives are related to each other through the concept of identifiability. Demonstratives express deixis relations in terms of spatial or temporal reference. Demonstratives locate the entities in spatial and temporal contexts

relative to some point of reference, for example, the distance between the speaker and the entity that is being specified. In this sense, demonstratives are of two types: proximal, referring to a location closer to the speaker, and distal, referring to a distance away from the speaker. The determiner forms are given in Table 2.3.

Agr.	Det/Dist	Dist pronoun	Det/Prox	Prox pronoun
3MSg	እቲ ?it-i	እቲ ?it-i	እዚ ?iz-i	እዚ ?iz-i
3FSg	እታ ?it-a	እቲኣ -?iti-?a	እዛ ?iz-a	እዚኣ ?izi-?a
3MH	እቶም ?it-om	እቲኦም ?iti-?om	እዞም ?iz-om	እዚኦም ?izi-?om
3FH	እተን ?it-än	እቲኡን ?iti-?än	እዞን ?iz-än	እዚኡን ?izi-?än
3MPI	እቶም ?it-om	እቲኣቶም ?iti-?atom	እዞም ?iz-om	እዚኣቶም ?izi-?atom
3FPI	እተን ?it-än	እቲኣተን ?iti-?atän	እዞን ?iz-än	እዚኣተን ?izi-?atän

Table 2.3: Tigrinya determiners

Determiners in Tigrinya inflect in two ways, except for the singular masculine forms ?it-i ‘the/that-M’ and ?iz-i ‘this-M’. One of these is a short form which consists of the stem ?it-, distal, or ?iz-, proximal, and the pronominal suffixes *-om* ‘3MPI’, *-a* ‘3FSg’ and *-än* ‘3FPI’ which are the same endings found in the pronoun system. The second is a long form which involves the stem ?iti or ?izi-, the consonantal infix *-?* and the pronominal suffixes *-om* ‘3MPI’, *-a* ‘3FSg’ and *-än* ‘3FPI’. The two determiner forms reflect a difference in their grammatical distribution. The short forms require obligatory noun complements, whereas the long forms have optional noun complements. However, the singular masculine forms are underspecified for these functions. Let us consider the following examples (19).

- (19) a. እቲ ወዲ መጸኡ ።
 ?it-i wädi mäši?u
 Det-3MSg boy.Sg PerfG-come-SM.3MSg
 ‘The boy has come.’
- b. ኣየናይ ወዲ?
 ?ayän-ay wädi
 Which-3MSg boy.Sg
 ‘Which boy?’
- c. እቲ ታማሊ ዝረኽብናዮ ።
 ?it-i timali zi-räkäb-na-yo
 Det-3MSg yesterday Rel-PerfH.meet-SM.1Pl-OM₁.3MSg
 ‘The one (he whom) we met yesterday.’

The determiner in (19a) specifies the referent of the noun *-wädi* ‘boy’. In this utterance the speaker assumes that the addressee can identify the referent. However, from the question in (19b) we understand that addressee fails to identify the referent. Then, the speaker gives more clarification in the form of a relative clause

- d. **ኣቲ ንስኹ ናብሊ ንዲ!**
 ?att-i nissi-ki nab-zi niʔ-i
 DetVoc-2FSg PRO.2FSg Loc-DetProx-3MSg Impr.come-SM.2FSg
 ‘Hey you(F) come here!’

Vocatives can stand alone as full pronouns (23a). They can also take various types of noun complements, for example, common nouns (23b) and personal nouns (23c). They can even specify/predetermine pronouns (23d), which is not possible with the third person determiners.

Tigrinya does not have articles to express indefiniteness, thus indefinite nouns are unmarked. Some Tigrinya grammar books identify the cardinal determiners *had-ä* ‘one-3MSg’ and *hant-i* ‘one-3FSg’ as marking indefinite nouns optionally (Mulugeta 2001, Tesfay 2002). However, a close look at their function reveals that they are markers of specificity. Lyons (1999:103) says that marking specific indefinites is a more common case than marking non-specific indefinites in the languages of the world. In accordance with this, in Tigrinya a noun with a non-specific indefinite referent appears bare and a noun with a specific indefinite referent appears with cardinal determiners, as illustrated below (24).

- (24) a. **ምስ ቀልዓ ኣይትምከር፡ ምስ ከልቢ**
 mis qolfa ?ay-ti-mkär mis kälbi
 Com child.Sg Neg-Imperf.2-confide.SM.MSg Com dog.Sg
ኣይትተሓባእ፡
 ?ay-ti-tä-ḥaba?
 Neg-Imperf.2-DT-hide.SM.MSg
 ‘Do not confide in a child; and do not hide yourself with a dog.’ (Tigrinya proverb)
- b. **እዚ [ዓል እትሰርሖ ስራሕ]**
 ?iz-i g^wal ?it-ti-särḥ-o ḥira
 DetProx-3MSg lady.Sg Rel-Imperf.3-work.SM.FSg-OM₁.3MSg work/job
ኣይኮነን፡
 ?ay-konä-n
 Neg-Pres.be.SM.3MSg-Neg
 ‘This is is not a job that a lady/woman can do.’
- c. **ሓደ ጊዜ ኣብ ሓደ ዓዲ ሓደ ቀልዓን ሓደ ከልብን**
 ḥadä gize ?ab ḥadä ?adi ḥadä qolʔa-n ḥadä kälbi-n
 one.M time Loc one.M village one.M child.Sg-Coord one.M dog.Sg-Coord
ነበሩ፡
 näbäru
 Past.be-SM.3MPI
 ‘Once upon a time there were a child and a dog in a certain village.’

- d. ኣብ ባቡር ምስ ኣንቲ ንል እናዕለልኩ ተጓዒዘ።
 ጎab babur mis ḥanti g^wal ጎina-ጎilälku täg^waጎizä
 Loc train Com one.F lady while-chat-1Sg DT-PerfG.travel-SM.1Sg
 ‘I traveled chatting with a certain lady on the train.’

In (24a) *qolጎa* ‘child’ and *kälbi* ‘dog’ are employed in a non-specific context and their referents can be any child and any dog. In (24c), however, *qolጎa* ‘child’ and *kälbi* ‘dog’ refer to a child and a dog that lived in a certain time and in a certain village. This strategy is used in order to set the scene for a fictitious story in an imaginary world. Thus, the story starts with specific characters placed in a specific time and location. In (24b) *g^wal* ‘girl/lady’ refers to women in general, thus is a non-specific identification, while in (24d) the noun *g^wal* ‘girl/lady’ refers to a specific person that the traveler spoke to, thus it is uniquely identifiable.

2.3.4 Quantifiers

Quantifiers are also classified as functional categories. They specify the referent of a noun in terms of size or amount. They also indicate partitive, existential and universal references. Words such as *ኩሉ kulu* ‘all.Coll’, *ገለ gälä* ‘some.Coll’, *ነፍሲ ወነፍ näfsi wäkäf* ‘every/each’, *ብዙስ bizuḥat* ‘many.Coll’, *ወሓድ wiḥudat* ‘few.Coll’, etc. and numerals such as *አደ/አንቲ ḥad-ä/ḥant-i* ‘one-M/one-F’ and *ክልተ kilitä* ‘two’ function as quantifiers in Tigrinya. This does not mean, however, that they have similar grammatical distribution patterns. For example, *ብዙሓት bizuḥat* ‘many.Pl’ and *ወሓዳት wiḥudat* ‘few.Pl’ and numerals can also be regarded as adjectives on the basis of their derivational forms and some of their grammatical properties. However, it is beyond our scope to go into a detailed discussion of this issue. Like determiners, quantifiers can bear pronominal markers, as in *ኩሉም kull-om* ‘All-3MPI/ all of them.M’, *ኩሉን kull-än* ‘All-3FPI/ all of them.F’, *ገለኡም gälit-om* ‘some-3MPI/ some of them.M’ and *ገለኡን gälit-än* ‘some-3FPI/ some of them.F’, etc. Furthermore, pronominally marked quantifiers carry a partitive reading in some contexts.

In the default reading, the universal quantifier *ኩሉ kullu* ‘all’ appears at the leftmost edge before deictic articles/demonstratives, but it can also occur in various positions to express different scoping relations (25).

- (25) a. ኩሉን እተን መጽሓፍቲ
 kull-än ጎit-än mäጱጎaf-ti
 All-FPI Det-3FPI book-Pl
 ‘all the books’

- b. እተን ኩለን ዮናስ ዝገዘአን መጽሓፍቲ
 ?it-än kull-än Yonas zi-gäz?-än mäṣḥaf-ti
 Det-3FPI All-FPI Yonas Rel-PerfH.buy.SM.3MSg-OM₁.3FPI book-PI
 ‘all of the books that Yonas bought’
- c. እተን ዮናስ ዝገዘአን መጽሓፍቲ ኩለን
 ?it-än Yonas zi-gäz?-än mäṣḥaf-ti kull-än
 Det-3FPI Yonas Rel-PerfH.buy.SM.3MSg-OM₁.3FPI book-PI All-FPI
 ‘the books that Yonas bought, all of them’

When the determiner is placed at the leftmost edge, it scopes over the whole nominal phrase (25a). It can also appear after determiners to express a partitive reading, as in (25b). It can also be positioned at the end of nominal phrase for emphasis, and it then stands in apposition with the nominal phrase, as can be seen from its meaning in (25c).

2.3.5 Possessive

A head noun can be modified by different types of possessive modifiers. Tigrinya has various ways of expressing possessive readings. Some frequent possibilities are nominal structures with genitive prepositions, possessive pronouns, possessive pronominal marking, double possessive, NN phrase and a construct state possessive. The prepositional possessor expression is marked by the genitive preposition ናይ *nay* ‘Gen/of’, as in (26).

- (26) (ናይ ተስፋይ) መጽሓፍ (ናይ ተስፋይ)
 (nay täsfay) mäṣḥaf (nay täsfay)
 (Gen Tesfay.M) book.Sg (Gen Tesfay.M)
 ‘book of Tesfay’

The canonical position of the prepositional possessive modifier is pre-nominal, therefore it precedes the head noun. PP possessive modifiers can also appear post-nominally, and in this structure they are emphasized.

Tigrinya also has possessive pronouns which are formed out of an invariable component – *nat* – and pronominal suffixes for the possessor. Table 2.4, lists the possessive pronoun forms of Tigrinya.

In some varieties of Tigrinya, possessive pronouns are formed by suffixing pronominal markers for the possessor directly on the genitive preposition *nay-*, as in ናይ *nay-u* ‘Gen-3MSg’ and *nay-a* ‘Gen-3MSg’ (Esayas 2003:46). However, it is not clear whether the radical *-t-* is a determiner or just a hiatus consonant to demarcate the syllabic boundary, as in ናቲ *na-t-u* ‘POSS-3MSg’ (27).

Possessive pronouns	Agreement values
ናቱ nat-u	POSS-3MSg
ናታ nat-a	POSS-3FSg
ናቶም nat-om	POSS-3MH
ናትን nat-än	POSS-3FH
ናታቶም nat-atom	POSS-3MPI
ናታተን nat-atän	POSS-3FPI
ናትካ nat-ka	POSS-2MSg
ናትኪ nat-ki	POSS-2FSg
ናትኩም nat-kum	POSS-2MH
ናትክን nat-kin	POSS-2FH
ናታትኩም nat-atkum	POSS-PI-2M
ናታትክን nat-atkin	POSS-F2PI
ናቲይ nat-äy	POSS-1Sg
ናትና nat-na	POSS-1PI

Table 2.4: Tigrinya possessive pronouns

- (27) **ናቱ መጽሐፍ**
 nat-u mäṣḥaf
 POSS-3MSG book.Sg
 ‘his book’

The noun head can also directly bear a pronominal suffix for the possessor, as in (28). The pronominal possessive structure appears to be more common than the overt possessive pronoun structure for reasons similar to those given in section 2.3.2 in the case of null and overt pronouns. However, the pronoun possessive structure and the pronominal possessive structure reflect different constraints than pronouns and pronominal verbal suffixes. For example, a possessive pronoun cannot occur overtly when the noun is pronominally marked (28b).

- (28) a. **መጽሐፍ**
 mäṣḥaf-u
 book.Sg-Poss.3MSG
 ‘his book’
- b. ***ናቱ መጽሐፍ**
 nat-u mäṣḥaf-u
 POSS-3MSG book-Poss.3MSG’

In the possessive expression the possessive feature is supplied either from the possessive pronoun or the pronominal suffix.

Like definite articles and demonstratives, possessive pronouns are functional heads of nominal phrases, but they are not in complementary distribution with other determiners. They can be predetermined by other determiners and they can optionally take a noun complement. When the referent of the possessee expression is

obvious, the head noun can be dropped from the possessive expression, and thus the possessive pronoun stands alone, as in (29).

- (29) a. **እዚ መጽሐፈይ እዩ።**
 ?iz-i məšħaf-äy ?iy-u
 DetProx-3MSg book-Poss.1Sg Pres.IDcop.be-SM.3MSg
 ‘This is my book.’
- b. **ናትካ ኣበይ ኣሎ?**
 nat-ka ?abäy ?all-o?
 POSS-2MSg where Pres.exist-SM.3MSg
 ‘Where is yours?’

In the first sentence (29a), the possessive expression consists of the head noun *mäšħaf* ‘book’, which corresponds to a possessee referent, and the pronominal marker -*äy* ‘Poss-1Sg’, which corresponds to a first person possessor referent. In the second sentence (29b), the possessive expression consists only of the possessive pronoun **ናትካ** *nat-ka* ‘POSS-2MSg’, the complement noun is dropped since it can be understood as referring to the book from the context given in the first clause.

The possessive structure in (30) is identified as a double possessive since the possessor is both realized as an overt noun and is also marked on the head noun through a pronominal suffix. The noun that corresponds to the possessor can be positioned on either side of the pronominally marked head noun and it is optional. The possessor noun obligatorily bears the prepositional objective case *ni*.

- (30) a. **(ንኣኡ/ ንተስፋይ) መጽሐፍ**
 (ni-?a?-u/ ni-tesfay) məšħaf-u
 (Obj-3MSg/ Obj-tesfay) book.Sg-POSS.3MSg
 ‘Tesfay’s book/ Lit. his book to Tesfay’
- b. **መጽሐፍ (ንኣኡ/ ንተስፋይ)**
 məšħaf-u (ni-?a?-u/ ni-tesfay)
 book.Sg-POSS.3MSg (Obj-3MSg/ Obj-tesfay)
 ‘Tesfay’s book/ Lit. his book to Tesfay’

The possessive expression with the possessor preceding the possessee is understood as the neutral word order (30a). In the neutral word order, the possessor noun has a focus discourse function. In this structure, the speaker presupposes that the addressee may not know the referent of the possessor noun, thus the speaker supplies new information which was not mentioned earlier in the discourse. On the other hand, in the expression where the possessor is in postposition (30b), the speaker assumes that hearer can identify the referent of the possessor noun which is marked through the pronominal suffix on the possessee noun.

In addition, Tigrinya employs a noun sequence as a possessive expression. The NN possessive structure is an exception to the typical head-final phrase and clause structure of Tigrinya. In the NN sequence, the first noun is the locus or head which codes the possessee and the second noun codes the modifier or the possessor, as in (31).

- (31) መጽሐፍ ተስፋይ
 mäṣḥaf täsfay
 book.Sg Tesfay.M
 ‘Tesfay’s book’

This possessive expression is formed by juxtaposing two uninflected nouns. The nouns are not inflected either for case or possessive pronominal agreement.

Tigrinya also employs the Semitic genitive structure known as the construct state to code a possessive reading. This construction is similar to the NN possessive except that the possessee noun in the construct state is morphologically inflected. It acquires the -ä- vocalic pattern in its final consonantal root. For example, the free forms ቤት *bet* ‘house’, ሰብ *säb* ‘person/people’ መዝገብ *mäzḡäb* ‘register’ and ንጉሥ *nigus* ‘king’ are inflected as ቤተ *betä*, ሰበ *säbä*, መዝገበ *mäzḡäbä* ‘register’ and ንጉሥ *nigusä*, respectively, when used as construct forms. This structure is common in phrases such as ቤተ መንግስቲ *betä mängisti* ‘house of government’ meaning ‘government’s administrative building’, ቤተ ክርስቲያን *betä kiristian* ‘house of Christian’ meaning ‘church’ or ቤተ ሰብ *betä säb* ‘house of person’ meaning ‘family’, ሰበ ስልጣን *säbä silṭan* ‘people of authority’ meaning ‘authorities’, መዝገበ ቃላት *mäzḡä bäqalat* ‘dictionary/ Lit. register of words’ and ንጉሥ ነገሥታት *nigusä näggästat* ‘king of the kings’. The construct state is considered to be an archaic construction, and is no longer productive in modern Tigrinya. In modern Tigrinya the NN structure is very common. Most of the construct state compounds reflect established idiomatic readings as in the meaning of ‘church’, ‘authorities’ and ‘family’. It should be also noted that both the NN and the construct state nominal structures can be syntactically ambiguous. They can code wider semantic relations or meanings other than the possessive since the same structure can be used to derive noun-noun compounds. For example, the NN sequences ክዳን ቀልጻ *kidan qolṣa* ‘garment child’ can mean a garment belonging to a certain or of the kind worn by children.

Possessive pronouns are classified as determiners in some languages (e.g. English, French) and as adjectives in others (e.g. in Italian). In Tigrinya, however, they reflect mixed properties. As shown in (32), possessive pronouns and determiners are not mutually exclusive.

- (32) እቲ ናታ መጽሐፍ
 ?it-i nat-a mäšħaf
 Det-3MSg PRO-Poss.3FSg book.Sg
 ‘(the) her book’

The determiner and the possessive pronoun can coexist in the same nominal expression. In Tigrinya the possessive pronoun behaves more like a modifier than a determiner.

2.3.6 Adjectives

Adjectives inflect according to the gender and number of the head noun. In (33a) the adjective is internally inflected for the masculine gender, and in (33b) it is inflected for the feminine gender. In most adjectives, the morpheme *-ti* marks the feminine gender along with internal changes in the vocalic templates of some of the consonantal roots. However, some adjectives do not inflect for gender, and thus they are used for both masculine and feminine, as shown in (33c).

- (33) a. ንፍዕ ወዲ
 nifuʔ wädi
 clever.M boy.MSg
 ‘a clever boy’
- b. ንፍዕቲ ንል
 nifiʔ-ti g^wal
 clever-F girl.FSg
 ‘a clever girl’
- c. ሓራቕ/ ዓሻ ሰብኣይ /ሰበይቲ
 ħaraq/ ʕaša säbʔay /säbäyti
 angry.Sg/ foolish.Sg man.MSg /woman.FSg
 ‘an angry/foolish man/woman’

Adjectives and nouns employ the same plural markers. For example, in (34a) the plural marker *-at* is suffixed on the adjective *nifiʔ-at* ‘clever-Pl’ and the noun *säb-at* ‘person-Pl’, and in (34b) the plural marker *-ti* is suffixed on the adjective *ʕabäy-ti* ‘big-Pl’ and the noun *mäšħaf-ti* ‘book-Pl’.

- (34) a. ንፍዓት ሰባት
 nifiʔ-at säb-at
 clever-Pl person-Pl
 ‘clever people’

- b. **ዓበይቲ መጽሐፍቲ**
 ʿabäy-ti mäṣṣḥaf-ti
 big-Pl book-Pl
 ‘big books’

2.3.7 Relatives

Relative modifiers are introduced via a morphological particle in Tigrinya (Palmer 1962). The particle *zi-*, which can also appear as *zi-* and *zä-* depending on the phonological environment in which it occurs, is the most common relative clause marker in Tigrinya. Other forms such as *ni-* and *?i-* are also used with some conjugations of the imperfective verb forms. The particle *?i-* is used when the person prefix is *ti-*, as with all second person subjects and third person feminine subjects, and *ni-* is used with first person plural subjects. The relative marker is the outermost prefix in the verb stem. It precedes all other kinds of inflectional (e.g. subject), derivational (e.g. causative, passive) and clausal (e.g. negation) prefixes. The relative marker attaches to both nouns and verbs. When it marks a noun it yields a possessive relative reading, and when it marks verbs it yields a nominal relative reading. The Tigrinya relative marker is underspecified for the various relative pronoun forms ‘which’, ‘who’, ‘that’, ‘whom’, ‘when’ ‘where’ and ‘whose’ found in languages such as English. Let us consider the following examples (35).

- (35) a. **እታ ዘጠፍአት መጽሐፍ**
 ?it-a zi-ṭäfi?ä-t mäṣṣḥaf
 Det-3FSg Rel-PerfH.disappear-SM.3FSg book.Sg
 ‘the book which/that has disappeared’
- b. **እታ እትፈትዎ ዓል**
 ?it-a ?i-ti-fätiw-a g^wal
 Det-3FSg Rel-Imperf.2-like.SM.MSg-OM₁.3FSg girl.Sg
 ‘the girl whom you like’
- c. **እታ ሓዲሽ ዘገበራ መጽሐፍ**
 ?it-a ḥadish zi-gäbär-a mäṣṣḥaf
 Det-3FSg new.MSg Rel-cover.Sg-Poss.3FSg book.Sg
 ‘the book with a new cover/ Lit. the book whose cover (is) new’

In (35a) and (35b) the relative morphemes *zi-* and *?i-* are prefixed to perfective and imperfective verb forms, respectively. However, in (35c) *zi-* is prefixed to a noun, and yields a possessive relative reading.

The relative modifier tends to precede other modifiers within the nominal phrase, as in (36).

- (36) እተን ናተይ ሓዲሽ ዝገበረን ክልተ ንበይቲ መጽሓፍቲ
 ?it-än natäy ḥadish zi-gäbär-än kiltä ?abäy-ti mäṣḥaf-ti
 Det-3FPI POSS.1Sg new.MSG Rel-cover.Sg-Poss.3FPI two big-PI book-PI
 ‘(the) my two big books whose covers (are) new’

The relative modifier *ḥadish zi-gäbär-än* ‘whose cover new’ comes right after the determiner and before all other modifiers.

2.4 Verbals

The morphology of the Tigrinya verb is often very complex. Like other Semitic languages, the derivational morphology of Tigrinya is characterized by the root-and-pattern or templatic morphology. The basic unit of a word is the ‘root’ which constitutes its semantic core. It is an abstract form since it does not exist as a word in the lexicon of a language. In most cases, the root consists of three consonants, also known as radicals, but the number may vary from two to five. These consonants interlock with different vocalic templates and are associated with prefixes and suffixes in order to derive a stem. For example, the radicals of the root **ሰብር** *sbr* combine with the vocalic pattern *ä* to derive the historic perfective stem **ሰበረ** *säbärä* ‘he broke’, and they combine with the vocalic patterns *ä*, *i* and *u*, respectively, to derive the simple/gerundive perfective stem **ሰቢሩ** *säbiru* ‘he broke’.

Moreover, some verbs geminate (double, lengthen) the middle radical of the verbal root in certain conjugational forms. Different vocalic templates together with prefixes and suffixes code tense-aspect, mood and agreement. The stem can also bear derivational prefixes and can vary in vocalic pattern to code a change in argument relations; for example, to derive detransitivized predicates (e.g. passive, reflexive and reciprocal) and causatives. The verb many also bear affixes to code phrase and clause information, for example, in relativization, complementation, negation and coordination phenomena.

In this section we will expand some of these points in order to illustrate the salient properties of verbs and the verbal elements that constitute verbals. We will use the term verbal for the Tigrinya verbal group in order to distinguish it from what is normally taken as a verb phrase (VP), a constituent that consists of a verb and its complements.

2.4.1 Basic verbal inflection

In Semitic languages verbs are portrayed as involving a two-way inflectional system – perfective and imperfective. Traditionally, the opposition between the perfective and imperfective verb forms is assumed to characterize a basic aspectual distinction. Perfective verbs are known as suffix forms since the subject is marked with a suffix. On the other hand, imperfective verbs are known as prefix forms since the subject is marked with a prefix. The suffix forms code a completed single whole action, while the prefix forms code an uncompleted action. Uncompleted actions are considered as non-past, and completed actions as past. Therefore, tense-aspect (TA) is treated as a single complex category in Semitic languages. Traditionally, verbs in Tigrinya are also classified along the bipartite, i.e. perfective vs. imperfective, inflectional system. Tigrinya has developed an additional perfective verb form which is designated as ‘gerund/gerundive’ in Tigrinya grammar books (Masson 1994:50), (Kogan 1997:439), (Tesfay 2002). The term ‘gerundive’ is a misnomer, however, since this verb form is inflected for tense-aspect and agreement, and it can also occur independently as a predicate in a main clause. The term was probably adopted to refer to its adverbial function in converb constructions. There, it expresses an action/event simultaneous with or an anterior to that expressed by a main verb (Lipiński (1997:418); Azeb and Dimmendaal (2006)). In this study we will refer to this verb form as a simple perfective, in contrast to the historic perfective, to emphasize its function as a tense-aspect marker of simple or single completed events.

Like in other Semitic languages, in Tigrinya perfective and imperfective verb forms are contrasted as suffix and prefix conjugations, respectively. This is because, in the perfective forms the subjects’ person, gender and number categories are coded by suffixes. On the other hand, some imperfective forms involve only a prefix, and some involve both a prefix and a suffix. This is illustrated in Table 2.5 through the perfective and imperfective conjugation of the verbal root ስብር *s-b-r* ‘break’.

PerfH	meaning	Imperf	meaning
ሰበረ säbär-ä	he broke	ይሰበር yi-säbbir-i	he breaks
ሰበሩ säbär-u	they (M) broke	ይሰበሩ yi-säbbir-u	they (M) break

Table 2.5: Suffix vs. prefix forms

In the perfective forms the vocalic patterns -ä and -u that are associated with the third radicals mark a 3MSg subject and a 3MPI subject, respectively. Since the

markers are vowel phonemes, they are not realized as distinct suffixes. Instead, they appear as vocalic patterns of the third radicals. In contrast, in the imperfective forms the prefix *yi-* codes a third person subject. In addition to the prefixes, imperfective verbs involve suffixes, *-i* ‘3MSg’ and *-u* ‘3MPI’, to code the gender and number categories of the subject. As in the perfective forms, since these are vowels, they appear as vocalic patterns of the last radical.

Tigrinya has four basic verb inflectional forms. Three of these, the historic perfective, the simple perfective and the imperfective, code tense-aspect, and the fourth form, the inflection for imperative, jussive and hortative, codes mood. The following table (2.6) illustrates these four basic inflectional forms through the conjugation of the verbal roots – **ሰብር** *s-b-r* ‘break’, **ፍጹም** *f-ṣṣ-m* ‘finish, accomplish’ and **ብርኽ** *b-r-k* ‘bless’ – for third person masculine singular subject.

Perfective		Imperfective		Root meaning
PerfH	PerfS	Imperf	Jussive	
ሰበረ säbär-ä	ሰበሩ säbir-u	ይሰብር yi-säbbir	ይሰበር yi-sbär	break
ፈጸመ fäṣṣäm-ä	ፈጸሙ fäṣṣim-u	ይፍጹም yi-fiṣṣim	ይፈጸም yi-fäṣṣim	finish
ብረኽ baräk-ä	ብረኹ barik-u	ይብርኽ yi-barik	ይብርኽ yi-barik	bless

Table 2.6: Perfective vs. Imperfective verb forms

These verbs belong to different verb types that are distinguished on the basis of their gemination patterns. Gemination is not orthographically marked in Tigrinya. Nevertheless, it becomes orthographically visible when the verbal roots of geminated consonants interact with certain vocalic patterns and inflectional affixes. For example, when the causative prefix *ʔa-* attaches to a non-geminated stem **ሰብረ** *ʔa-sibärä*, the vocalic template of the first consonant changes into *-i-*, whereas when it attaches to a geminated stem **ፈጸመ** *ʔa-fäṣṣämä*, the templates remain unchanged. Verbs of the **ሰብር** *s-b-r* type (also known as type A) undergo gemination only in the imperfective forms that do not bear suffixes, i.e. the imperfective conjugation of 1Sg, 1Pl, 2MSg, 3MSg and 3FSg. Verbs of the **ፍጹም** *f-ṣṣ-m* type (also known as type B) geminate in all basic inflectional forms, while verbs of the **ብርኽ** *b-r-k* type (also known type C) do not geminate at all.

Perfective

As mentioned earlier, Tigrinya has two perfective verb forms. These are distinguished by the vocalic pattern associated with the middle radical of a root consisting of three consonants. In the perfective historic stem the middle radical has the

vocalic pattern -ä-, while in the simple perfective stem the middle radical has the vocalic pattern -i-. The two perfective stems also differ in the agreement suffixes for the third person and the first person singular subjects. Agreement markers consisting of vowels merge with the last radical in the template, whereas those which consist of syllabic forms (i.e. consonant plus vowel) appear as distinct suffixes. This is shown in Table 2.7.

Agr. Values	Perfective		Imperfective	
	PerfH	PerfS	Imperf	Jussive
3MSg	säbär-ä	säbir-u	yi-säbbir-ø	yi-sibär-ø
3FSg	säbär-ät	säbir-a	ti-säbbir-ø	ti-sibär-ø
3MPI	säbär-u	säbir-om	yi-säbir-u	yi-sibär-u
3FPI	säbär-a	säbir-än	yi-säbir-a	yi-sibär-a
2MSg	säbär-ka	säbir-ka	ti-säbbir-ø	sibär-ø
2FSg	säbär-ki	säbir-ki	ti-säbir-i	sibär-i
2MPI	säbär-kum	säbir-kum	ti-säbir-u	sibär-u
2FPI	säbär-kin	säbir-kin	ti-säbir-a	sibär-a
1Sg	säbär-ku	säbir-ä	?i-säbbir-ø	?i-sibär-ø
1Pl	säbär-na	säbir-na	ni-säbbir-ø	ni-sibär-ø

Table 2.7: Suffix and prefix inflection

Both perfective verb forms denote completed events, and they may be used in both main and dependent clauses. The historic perfective expresses a completed event that consists of a chain of events. It serves to mark cohesive relations in narration. In this sense, it can be said that it has a pragmatic function. Even though the single event denoted by it is completed and is independent, it reflects some sort of suspense in that the narrator is expected to say more about the story. In fact, this verb form is very common in story telling and narratives of past events. Let us consider the following examples (37).

- (37) የኖስ ብ1985 ኣብ ከረን ተወልደ። ክሳብ ወዲ ዓስርተ ዓመት
 Yonas bi-1985 ?ab kärän tä-wälidä kisab wädi ?asärtä ?amät
 Yonas.M Instr-1985 Loc Keren DT-PerfH.bear.SM.3MSg until boy ten year
 ዝኸውን ምስ ወለዱ ዓበየ።
 zi-käwin mis wälädu ?abäyä
 Rel-PerfH.become.SM.3MSg Com parent-Poss.3MSg PerfH.grow.SM.3MSg
 ድኸሪኡ ወለዱ ንገዳም
 di?hri-?u wälädu ngädäm
 after-Det-3MSg parent-Poss.3MSg DIF-monastery PerfH.send-SM.3MPI-OM₁.3MSg
 ሰደዱዎ።
 sädäd-u-wo

‘Yonas was born in 1985 in Keren. Until he was a ten year old boy, he grew up with his parents. After that his parents sent him to a monastery....’

These three sentences in example (37) constitute a narrative chain, thus the main verbs are in the historic perfective. These sentences give only some details out of Yonas' life history, and so the ending of the last sentence leads one to wonder what will happen next.

On the other hand, for a completed single and isolated event that denotes the result of an action in the past the simple perfective form is used. For example, when we ask a question and give an answer based on the story in (37), we would use the simple perfective form, as in (38) and (39).

- (38) a. **ዮናስ ምግስ ተወለዱ?**
 Yonas miገas tä-wälid-u
 Yonas.M when DT-PerfS-bear-SM.3MSg
 'When was Yonas born?'
- b. **ብ1985 ተወለዱ።**
 bi-1985 tä-wälid-u
 Instr-1985 DT-PerfS-bear-SM.3MSg
 'He was born in 1985.'
- (39) a. **ዮናስ ምስ መን ዓብዩ?**
 Yonas mis mäm ገabiy-u
 Yonas Com who PerfS.grow-SM.3MSg
 'With whom did Yonas grow up?'
- b. **ምስ ወለዱ ዓብዩ።**
 mis wäläd-u ገabiy-u
 Com parent-Poss.3MSg PerfS.grow-SM.3MSg
 'He grew up with his parents.'

The simple perfective is widespread in converb constructions. The converb construction employs two simple perfective verb forms to express notions of adverbial subordination, comparable to clauses in English beginning with *while*, *when* and *after*. The converb expression denotes an action simultaneous with or anterior to the action expressed by the main verb. The order of the verbs codes the chronological order of the events. The adverbial interpretation depends on the lexical aspect (Aktionsart) of the verbs involved, and also on the interaction of their meanings. For example, with punctual verbs the converb is interpreted as anterior, whereas with durative verbs it is interpreted as simultaneous with the event denoted by the main verb. In (40) we contrast the adverbial senses of a punctual simple perfective verb (40a) and a durative simple perfective verb (40b) followed by simple perfective forms.

- (40) a. በሊዑ መጸኢ ።
 bälīyī-u mäsīʔ-u
 PerfS.eat-SM.3MSg PerfS.come-SM.3MSg
 ‘He ate before he came.’
- b. ዮናስ ነታ መጽሐፍ ሒዘዎ
 Yonas nä-t-a mäṣṣəḥaf hiz-u-wa
 Yonas.M Obj-Det-3FSg book.Sg PerfS.held-SM.3MSg-OM₁.3FSg
 መጸኢ ።
 mäsīʔ-u
 PerfS.come-SM.3MSg
 ‘Yonas came and brought the book (F) along with him. Lit. Yonas held the book, and then he came.’

The difference between the two types of verbs lies within their inherent aspectual meaning. Grammatically, the event denoted by the converb is completed, in the sense that the actions of eating and holding are accomplished. For punctual verbs such as ‘eat’ the achieved state cannot be continued, thus it is halted, whereas for durative verbs such as ‘hold’ the achieved state can be extended. Therefore, these aspectual differences give rise to the adverbial reading of ‘anterior’ and ‘simultaneous’ in converb constructions, and as we are going to see later, the same phenomenon is reflected in the derivation of sub-aspectual meanings such as the progressive, inceptive, prospective, etc. The converb does not bear any adverbial marking, that is, it is not inflected in a special manner to indicate its dependence. Therefore, it is a finite form. This is a special property of converbs in Tigrinya, as in Amharic, a related Ethiopian Semitic language, converbs are inflected for this function, and are thus distinct from the independent perfective verb form (Azeb and Dimmendaal 2006:410-411).

Imperfective

The imperfective form is used to denote an uncompleted event that occurs repeatedly and habitually. The examples in (41) illustrate these functions.

- (41) a. ዮናስ ኩሉ ጊዜ ብርጭቆ ይሰበር ።
 Yonas kulu gize birçiqo yi-säbir
 Yonas.M all-M time glass.Sg Imperf.3-break.SM.MSg
 ‘Yonas always breaks a glass.’
- b. ዮናስ ስርሑ ብግቡኣ ይፍጽም ።
 Yonas siriḥ-u bi-bibu? yi-fiṣṣim
 Yonas.M work-Poss.3MSg Instr-responsibility Imperf3-accomplish.SM.MSg
 ‘Yonas accomplishes his job responsibly.’

- b. ነቲ ብርጭቕ ስበሮ!
 nä-t-i birçiqo sibär-o
 Obj-Det-3MSg glass.Sg Impr.break.SM.2MSg-OM₁.3MSg
 ‘Break the glass!’
- c. ኩልና ነቲ ብርጭቕ ንስበሮ
 kuli-na nä-t-i birçiqo ni-si bär-o
 All-1Pl Obj-Det-3MSg glass.Sg Hort.SM.1Pl-break-OM₁.3MSg
 ‘Let us all break the glass.’

The jussive is the volitive mood of the third person (42a). It can denote wish, permission or command depending on the context of use. The jussive form codes third person subjects, and it bears a person prefix similar to that of the imperfective verb form, but it is associated with different vocalic templates than the imperfective. The imperative is the volitive mood of the second person (42b), and it mainly expresses a command submitted by the speaker for immediate action (here and now), but can also express other milder nuances such as permission, wish, insistence, etc. when expressed with a soft tone of voice. The verb codes a second person subject which is indicated only through vocalic patterns. The hortative is the volitive mood of the first person (42c), and it expresses the speaker’s wish, intention, desire or self-encouragement to perform the action (1Sg), or an exhortation or proposal to do something together with others (1Pl). Like the jussive, it bears person prefixes similar to that of the imperfective, but it is associated with vocalic patterns that are different from those used in the imperfective form.

2.4.2 Derived verbal roots

Some of the basic inflectional forms are used as a basis for the derivation of other verb forms. The imperfective is used as the base of the purposive, and the perfective historic is used as the base of the subjunctive. The verbal noun is also another derived form. However, the base it uses is not associated with the perfective or imperfective templates. Table 2.8 illustrates the derivation of these three verb forms.

Purposive=ki-Imperf	subjunctive=mi-PerfH	VN mi-CiCaC
ኪሰበር k-i-säbir	ምስበረ mi-säbärä	ምስበር / mi-sbar
ኪፍጸም k-i-fäṣṣam	ምፈጸም mi-fäṣṣämä	ምፍጸም mi-fäṣṣam
ኪባርኽ k-i-barik	ምባረኽ mi-baräkä	ምባረኽ mi-brak

Table 2.8: Derived verb form

This particle *ki-* is attached to the imperfective stem to derive a purposive verb. This verb form is used in the expression of future tense and in complement

The particle **ም** *mi-* is prefixed to the verbal template -CiCaC to derive verbal nouns. The stem that this particle prefixes to is not related to any of the aspectual or mood inflectional forms discussed above. The verbal noun is the only verbal form in Tigrinya which is not inflected for tense-aspect and is not marked for subject agreement. On the other hand, it can bear a pronominal suffix to mark a possessor which indicates its nominal category (45a). It is also used to name actions and states, similar to gerunds in English. This is illustrated in (45b) and (45c).

- (45) a. **ምምጻእካ ኣይፈለጥኩን ።**
 mi-mṣaʔ-ka ʔay-fälät-ku-n
 VN-come-Poss.2MSg Neg-PerfH.know-SM.1Sg-Neg
 ‘I did not know (about) your coming’
- b. **ዮናስ ምስዕሳዕ ይኸእል እዩ ።**
 Yonas misiʔsaʔ yi-kiʔil ʔiyy-u
 Yonas VN-dance Imperf.3-be=able.SM.MSg Pres.IDcop.be-SM.3MSg
 ‘Yonas is able to dance (dancing).’
- c. **ምንጋር ኣብያትኒ ።**
 mi-ngar ʔaby-at-ni
 VN-tell PerfS-refuse-SM.3FSg-OM₁.1Sg
 ‘She refused to tell me./ She refused telling me.’

The particle **ም** *mi-* attaches to the historic perfective form to derive a subjunctive verb form to express a wish and a condition contrary to fact. The subjunctive form is used to express a hypothetical state of affairs in conditional sentences (46a) and to express a wish in simple clauses (46b). The subjunctive form is also used to express pragmatic functions such as politeness and conjecture (46c).

- (46) a. **ገንዘብ እንተ ዚደልይ ፡ ካባይ**
 gänzäb ʔintä z-i-däliy-ø kab-ay
 money if Rel-Imperf.3-want-SM.3MSg ABL-Pro.1Sg
ምወሰድ ።
 mi-wäsäd-ä
 Subjun-PerfH.take-3MSg
 ‘If he wants money, he would take from me.’
- b. **ኣብዚ ክትህልዉ ምደለኹ ።**
 ʔab-z-i ki-t-hiliw-u midäläläḵ-u
 Loc-Det-3MSg Purp-Imperf.2-be/exist-Sg Subjun-PerfH.want-1Sg
 ‘I wish you would be here.’
- c. **እታ መጽሓፍ ምሃብካኒ ዶ?**
 ʔit-a mäṣḥaf mi-hab-ka-ni do
 Det-3FSg book.Sg Subjun-PerfH.give-SM.2MSg-OM₁.1Sg Q
 ‘Would you give me the book?’

In the following section we will briefly discuss the derivation of copula verbs and their function in predication constructions.

2.4.3 Copular derivation

Copula verbs are a type of verb that serves to link a subject with a predicate complement. In contrast to other verbal complements, the predicate complements do not identify a participant or an individual, rather they express a predication about the identity, state or location of the subject, among other things. For this reason, copula verbs are assumed to be semantically null, in the sense that they do not have a meaning of their own. Hence, they function just as linking elements to connect the subject with what is predicated about it.

Tigrinya has two types of copula verbs: **እዩ** *?iyy-u* ‘be-3MSg’ and **ኣሎ** *?all-o* ‘exist/locate-3MSg’, which select different predicate types. The former predicates properties that are considered essential to the subject, whereas the latter predicates states that are considered accidental. The former is associated with nominal and adjectival predication that refers to permanent properties, and the latter with locational and temporal predication. In order to help us distinguish them, we will call **እዩ** *?iyy-u* the identity copula (IDcop) and **ኣሎ** *?all-o* the locative copula (Locop). The Tigrinya copulas seem to contrast with the copula verb distinction found in Italian and Spanish, as in ‘essere/ser’ and ‘stare/estar’ in their function (Bernini (2003:162), Arche (2006:15-18)). Moreover, copula verbs are very peculiar in their inflectional system. They do not follow the regular conjugation that involves interdigitation of consonantal roots with vocalic templates in the present since they do not contain full consonantal roots. as may be seen from the forms in Table 2.9.

Present	past/PerfS	neg-present	neg-PerfH	root meaning
እዩ <i>?iyy-u</i>	ነዩሩ <i>näyyir-u</i>	ኣይኮነን <i>?ay-konä-n</i>	ኣይነበረን <i>?ay-näbärä-n</i>	be-identity
ኣሎ <i>?all-o</i>	ነዩሩ <i>näyyir-u</i>	የሎን <i>y-ällo-n</i>	ኣይነበረን <i>?ay-näbärä-n</i>	be-locative

Table 2.9: Copula verbs

In the present tense the invariable form *?iyy-* for the IDcop and the invariable form *?all-* for the Locop are used as bases to which agreement suffixes are added. The IDcop employs the nominal agreement types, while the Locop employs the object suffix form. Both copula forms have the same past tense form which is conjugated in the simple perfective. However, different verbal roots are employed for the present and past negation forms.

Tigrinya uses linking verbs extensively, unlike the prototypical Semitic lan-

guages. The verbless predicational construction is known to be an important typological property of Semitic languages, including Ge'ez (Dillmann and Bezold 2005:497). However, this phenomenon is absent in the modern Ethio-Eritrean Semitic languages.

The alternation between the two types of copula, the IDcop and the Locop, is semantically motivated to a large extent. The type of predications they make correlates with different properties that are predicated about the subject. The properties predicated by IDcop are essential and integral to the individual or the entity referred to by the subject, or are properties that are characteristic of it (47).

- (47) a. የናስ ተመሃራይ እዩ ።
 Yonas tämäharay ?iyy-u
 Yonas.M student.Sg Pres.IDcop-be-SM.3MSg
 'Yonas is a student.'
- b. የናስ ጽቡቕ እዩ ።
 Yonas şibbuq ?iyy-u
 Yonas.M good.MSG Pres.IDcop.be-SM.3MSg
 'Yonas is handsome./ Lit. Yonas is good-looking.'

In (47a) the IDcop links the subject and a nominal predicate complement, predicating being a student is characteristic of the subject referent. In (47b) the IDcop links the subject and an adjectival predicate complement, expressing that being handsome is a characteristic property of the subject referent.

In contrast, the properties predicated by Locop refer to spatial and temporal manifestations, i.e. states and locations, of the subject. The following examples illustrate this distinction (48).

- (48) a. የናስ ጽቡቕ ኣሎ ።
 Yonas şibbuq ?all-o
 Yonas.M good-Pres. Pres.Locop.exist-SM.3MSg
 'Yonas is fine.'
- b. የናስ ኣብ ገዛ ኣሎ ።
 Yonas ?ab gāza ?all-o
 Yonas.M Loc home.Sg Pres.Locop.exist-SM.3MSg
 'Yonas is at home.'

Sentence (48a) expresses a temporal state reading which can be contrasted with the permanent state reading expressed by sentence (47a). The adjective şibbuq assumes different meanings depending on the type of copula verb employed. In (47a) it is interpreted as 'handsome' or 'beautiful' to predicate a permanent property that is integral to the individual's physical or psychological self, whereas in (48a) şibbuq

is interpreted as ‘fine’ or ‘good’, referring to the individual’s well-being, which is perceived as a temporal state. Similarly, locational predications are also perceived as a temporal manifestation of the entity predicates, as in (48a).

When an object pronominal suffix is attached to the locative copula, the copula expresses possession. The object pronominal suffixes of the type OM₁ code the possessor, and the subject pronominal suffixes code the possessee. Heine (1997:50-53) reports several languages (Turkish, Fijian, Estonian and Modern Irish, among others) that use this kind of schema for their possessive constructions. The possessive construction is coded as a topicalized construction, thus the typical word order in a possessive construction is OSV. Let us consider the following examples (49).

- (49) a. (ን)ዮናስ ኣብዑር ኣሎዉዎ ።
 (ni-)Yonas ?abiʕur ?allo-wu-wo
 (Obj-)Yonas bull.MPI Pres.Loc-loc.exist-SM.3MPI-OM₁.3MSg
 ‘Yonas has bulls./Lit. (For) Yonas, bulls exist.’
- b. (ን)ዮናስ ላዎ ኣላቶ ።
 (ni-)Yonas lam ?all-a-to
 (Obj-)Yonas cow.FSg Pres.Loc-loc.exist-SM.3FSg-OM₁.3MSg
 ‘Yonas has a cow./Lit. (For) Yonas, a cow exists.’

As we can see from these examples, the subject marker varies according to the gender and number of the subject referent. In (49a) the subject suffix shows 3MPI agreement with ?abiʕur ‘bulls’, while in (49b) the subject suffix shows 3FSg agreement with lam ‘cow’. The nominal that is associated with the possessor bears an optional objective case marker. In Tigrinya there is a tendency to optionally case mark topicalized object functions. (This tendency is also observed in preposed experiencer applied objects, see section 4.4.6). The possessor is portrayed as the most prominent argument and since the possessee is less prominent, they are postposed. This kind of structure is analyzed as an applicative phenomenon (see also section 4.4.7 for more information). Let us compare the following locative applicative (50) with the possession constructions in (49).

- (50) እታ ገዛ ሰብ ኣሎዎ ።
 ?it-a gäza säb ?all-o-wa
 Det-3FSg house person Pres.Loc-loc.exist-SM.3MSg-OM₁.3FSg
 ‘The house has a person in it./There are people in the house.’

As this example shows, the locative applicative and the possessive construction are structurally equivalent. The difference is in their meaning. The locative and possessive readings are obtained from the semantic properties of the referents.

In addition, copula verbs also function as auxiliaries and modal verbs to express various sub-aspectual (Aktionsart) types, tense and modality in combination with the basic aspectual forms – perfective vs. imperfective – and the derived purposive form.

In the following section, we will briefly present derivational affixes that code changes in valence in the verbal stem.

2.4.4 Valence-changing morphology

Tigrinya has two morphological operations that affect the argument structure of the basic verbal stem. One has detransitivizing and the other a transitivizing function. The detransitivizing operation is characterized by argument reduction. Typically, it applies to transitive verbs and demotes the highest argument of the verb which assumes an actor or agent semantic role. The detransitivization operation brings about various phenomena such as passivization (personal and impersonal), anticausative, reflexivization and reciprocation. It can also attach to a few intransitive verbs to derive impersonal readings. The detransitivized verb form involves both prefixes and change in vocalic templates. The causative operation, on the other hand, increases the number of arguments in the argument structure of the basic predicate. It brings an extra argument which bears a causer semantic role. When it applies to transitive verbs, the causer is expressed as a subject and the original agent argument of the basic predicate is coded as an object. These points will be illustrated in more detail in the remainder of this section.

Valence reducing devices (detransitivizing)

A detransitivizing device (DT) is a morphological means for coding various patterns of redundancy of subcategorizable arguments such as passive, reflexive and reciprocal. Arguments that are made redundant are not available for mapping onto grammatical functions in a canonical manner. Tigrinya employs prefixes and vocalic pattern changes to code detransitivization. Imperfective and perfective verb forms involve different types of derivational processes. The imperfective form involves changes in vocalic templates, whereas the perfective forms are marked with the passive prefix **†** *tä-*. Detransitivized forms of the perfective and imperfective stems of the root **ሰብር** *sbr* ‘break’ are given in Table 2.10, and these can be compared with the basic verbal inflectional forms given earlier in Table 2.6.

For example, the active imperfective stem *yi-säbbir* ‘he breaks’ and the detran-

Agreement	DT Perfective Historic	DT Perfective Simple	DT Imperfective
3MSg	ተሰበረ tä-säbär-ä	ተሰበሩ tä-säbir-u	ይሰበር yi-sibbär
2MSg	ተሰበርካ tä-säbär-ka	ተሰበርካ tä-säbir-ka	ትሰበር ti-sibbär
1Sg	ተሰበርኩ tä-säbär-ku	ተሰበረ tä-säbir-ä	እሰበር ?i-sibbär

Table 2.10: Detransitivized verb forms

sitivized stem *yi-sibbär* ‘it breaks/ it is broken’ are differentiated by the vocalic patterns of the first and the second radicals. The active and the detransitivized imperfective stems can be schematized by the templates $-C_1\ddot{a}C_2C_2iC_3-$ and $-C_1iC_2C_2\ddot{a}C_3-$, respectively. In contrast, the active perfective stems *säbärä* ‘he broke’ and the detransitivized stem *tä-säbärä* ‘it broke/ it was broken’ are differentiated only by the DT prefix *tä*.

The passive reading is commonly obtained from a transitive predicate. Transitive predicates are subcategorized for two arguments: an agent and a theme/patient. In the active, the actor/agent argument is morphosyntactically expressed as a subject, whereas, in the passive, it is the theme/patient argument that corresponds to the subject. The following example contrasts active and passive clauses (51).

- (51) a. **ሳባ ነቲ ስራሕ ብሓደ መዓልቲ**
 Saba(F) n-ät-i sirah bi-ḥadä mäʿalti
 Saba.F Obj-Det-3MSg job Instr-one day
ፈጸመቶ።
 fäṣṣim-a-to
 PerfS.complete-SM.3FSg-OM₁.3MSg
 ‘Saba completed/did the job in one day.’
- b. **እቲ ስራሕ ብሓደ መዓልቲ ተፈጸመ።**
 ?it-i sirah bi-ḥadä mäʿalti tä-fäṣṣim-u
 Det-3MSg job Instr-one day DT-PerfS.complete-SM.3MSg
 ‘The job was completed/done in one day.’

In (51a) the subject pronominal suffix corresponds to ‘Saba’, which is the referent of the agent argument. The object pronominal suffix corresponds to the theme argument which has *sirah* ‘job’ as its referent. In the passive construction (51b) the passive predicate bears the perfective DT prefix *tä-* and a subject pronominal suffix which corresponds to the theme argument *sirah* ‘job’.

The agent argument usually remains unexpressed since it sounds monotonous to overtly express it in a neutral clause. The expression of the agent argument in passive constructions can create a difference in meaning (52).

- (52) a. **ኣነ ኣይእባረኸን እየ!**
 ?anä ?ay-?i-baräki-n ?iy-ä
 PRO.1Sg Neg-Imperf.SM.1Sg-DT.bless-Neg Pres.IDcop.be-1Sg
 ‘I will not be blessed!’
- b. **ኣነ ብኣኻ ኣይእባረኸን እየ!**
 ?anä bi-?aka ?ay-?i-baräki-n
 PRO.1Sg Instr-Pro.2MSg Neg-Imperf.SM.1Sg-DT.bless-Neg
 Pres.IDcop.be-1Sg
 ‘I will not be blessed by YOU!’

In the clause where the agent is omitted (52a), the patient argument is topical and the predication about it, i.e. the statement about its referent’s refusal to be blessed, is focused in the discourse. On the other hand, the agent argument has a focus function when it is overtly expressed through an agentive adjunct phrase, the prepositional phrase marked by *bi* -‘by’ (52b).

In Tigrinya, some intransitive verbs can also be detransitivized. For example, ergative verbs such as **ተገዮያ** *tä-g^wäyiy-a* ‘she has been run after’, **ተበጸሐ** *tä-bäsih-a* ‘she/ has been arrived at (i.e. visited)’, **ተኣተያ** *tä-?atiy-a* ‘It.F has been entered’ and **ተላሐቐ** *tä-sahiq-a* ‘she has been laughed at’ code referential arguments that correspond to obliques semantic roles to express a goal argument reading. However, some unaccusative verbs can also be detransitivized, but then the subject in the passive predicate corresponds to a non-referential argument, as in (53). In this example, the verb is marked with a subject pronominal suffix which corresponds to an impersonal subject, and an object pronominal suffix which corresponds to a locative applied object.

- (53) a. **እታ/ነታ ዓራት ተደቂሱላ**
 ?it-a/n-ät-a ?arat tä-däqis-u-lu
 Det-3FSg/Obj-Det-3FSg bed DT-PerfS.sleep-SM.3MSg-OM₂.3FSg
ነይሩ ።
 näyr-u
 Pres.be-3MSg
 ‘The bed had been slept in.’
- b. **እታ/ነታ ኣዳራሽ ብዙስ ጊዜ**
 ?it-a/n-ät-a ?addarašbizuḥ gize tä-safisiḥ-u-la
 Det-3FSg/Obj-Det-3FSg hall many time
ተሳዕሲዑላ **ነይሩ ።**
 näyir-u
 DT-PerfS.dance-SM.MSg-OM₂.3FSg Past.be-SM.3MSg
 ‘In the hall, it has been danced in many times.’

The subject verbal suffix (3MSg) in these examples does not correspond to a referential argument. Since the predicate is detransitivized, it cannot code an agent with the subject suffix. However, the agent argument can be expressed through adjunct phrases such as ብከሙማት *bi-ḥimumat* ‘by patients’ or ብአጋይሽ *bi-ʔagayiš* ‘by guests’ in these clauses which shows that the subject of these passive predicates do not have referential arguments. The object suffixes correspond to the applied locative arguments *ʕarat* ‘bed’ (53a) and *ʔaddaraš* ‘hall’ (53b). Thus applicative constructions have a topicalization function. The locative applied object is in clause initial position and bears an optional objective case marking.

An impersonal passive structure is also used to express irony, sarcasm or mockery, as it expresses comments indirectly. Sarcastic passive comments are employed when the speaker does not fully believe that the person who does something is good enough at it or manages to do it well. It can also imply that the speaker is surprised that someone manages to do something unexpected of them both in a positive and a negative sense. Let us compare an active and a passive sarcastic expression (54).

- (54) a. **ሳዕሲዐ** **ኢልካ** **ዲኻ?**
 saʕsiʕ-ä ʔil-ka d-i-kaʔ
 PerfS.dance-SM.1Sg PerfS.say-2MSg Q-pres.Id.cop.be-2MSg
 ‘So, you think you have danced?!/Lit. Are you saying ‘I have danced?!’
- b. **ተሳዕሲዐ-ለይ** **እኮ** **’ዩ!**
 tä-saʕsiʕ-u-läy ʔiko ’y-u
 DT-PerfS.dance-SM.3MSg-OM₂.1Sg indeed ’Pres.Id.Loc.be-3MSg
 ‘As matter of fact, he thinks he danced well./ Lit. Indeed, it has been danced for me!’

The intransitive predicate *tä-saʕsiʕ-u-läy* ‘it has been danced for me’ (54b) is in the detransitivized form. The applicatively marked argument, which is indexed as first person (1Sg) object, can be interpreted as a beneficiary or maleficiary argument depending on the type of comment the speaker intends to make.

Another phenomenon that involves a detransitivized verb form is the anticausative. The anticausative is the inverse of causative (Dixon and Aikhenvald 2000:7). The anticausative derives an intransitive predicate out of a transitive. The argument coded as the subject in the anticausative structure corresponds to the undergoer in the intransitive clause. Predicates that involve the anticausative structure within their lexical meaning imply that the state or action denoted by them can happen ‘spontaneously’ without the involvement of an agent or a causer. Since there is no formal distinction between the passive and the anticausative, the detransitivized predicate can be ambiguous in these cases. Let us consider the following examples

(55).

- (55) a. ዮናስ ነታ ጥርመዝ ሰቢሩዋ ።
 Yonas n-ät-a ṭirmuz säbir-u-wa
 Yonas.M Obj-Det-3FSg bottle.Sg PerfS.break-SM.3MSg-OM₁.3FSg
 ‘Yonas broke the bottle.’
- b. እታ ጥርመዝ ተሰቢራ ።
 ?it-a ṭirmuz tä-säbir-a
 Det-3FSg bottle.Sg DT-PerfS.break-SM.3FSg
 ‘The bottle broke.’
- c. እታ ጥርመዝ ባፅላ ተሰቢራ ።
 ?it-a ṭirmuz baʿila tä-säbir-a
 Det-3FSg bottle.Sg self-3MSg DT-PerfS.break-SM.3FSg
 ‘The bottle broke by itself.’

In the absence of a clear context, the sentence (55b) can have a passive or an anticausative reading. The anticausative reading stresses that the ‘breaking’ can also happen without having been caused by anyone. The anticausative reading can be enhanced by using the emphatic reflexive pronoun *baʿila* ‘self-F’ which highlights the fact that there was not any external causer involved (55c).

In addition to the passive and the anticausative phenomena, detransitized verb forms also have reflexive readings. The reflexive structure involves a different argument reduction pattern than the structures discussed above. The reflexive clause has only one referential argument expressed as a subject which can assume the role of an agent and a theme simultaneously. Thus, the reflexive argument structure codes two semantic arguments that link to the same grammatical function. Tigrinya expresses reflexivization in two ways, through the nominal reflexive and the verbal reflexive structures. The nominal reflexive structure involves an active transitive verb which is subcategorized for a subject as well as an object realized as a reflexive pronoun. The object argument is coreferential with the subject argument. The reflexive pronoun is marked with the objective case, thereby indicating its grammatical function status. Haspelmath (2008:44) terms the kind of verbs (e.g. kill, like, hate, love, hear, etc.) commonly used in this reflexive expression as ‘extroverted’ verbs (Haspelmath 2008:44). The nominal reflexive strategy was already presented in section 2.3.2. Below (56) we repeat example (17a) for the sake of illustration.

- (56) ኣምላኽ ንባፅላ ክፈጥር
 ?amilak ni-baʿil-u k-i-fäṭṭir
 God.M Obj-PRORefl-Poss.3MSg Purp-Imperf.3-create.SM.MSg

ይኸአል	ድዩ?
yi-kǝʔil	di-y-u
Imperf.3-be=able.SM.MSg	Q-Pres.be-SM.3MSg
‘Is God able to create himself?’	

In this example, the verb *kǝʔtir* ‘he to create’ is an active transitive predicate. It requires an agent argument, the entity that creates, and a theme argument, the entity that is been created. The reflexive reading is realized through the use of the objective reflexive pronoun *nǝbaʕlu* ‘to himself’ which is coreferential with the subject *ʔamilak* ‘God’.

The second reflexive strategy, the verbal reflexive, employs a detransitivized verb form. Verbs that denote self-grooming events or activities that are performed on one’s own body such as **ተሐጸበ** *täḥaṣbä* ‘he washed himself’, **ተላጸዩ** *tälaṣäyä* ‘he shaved himself’ and **ተመሸጠ** *tämäṣätä* ‘he combed himself’, etc. are commonly employed in these expressions. Haspelmath (2008:44) terms such verbs as ‘introverted’ types. It is also common to express the locus of self-grooming overtly through a noun phrase in apposition to the subject (57).

- (57) a. **ሳባ ሰውነታ ተሐጸባ ።**
 Saba säwnät-a tä-ḥaṣib-a
 Saba.F body-Poss.3FSg DT-PerfS.wash-SM.3FSg
 ‘Saba washed herself./ Lit. Saba, her body has been washed.’
- b. **ዮናስ ጭሕሙ ተላጸዩ ።**
 Yonas çihm-u tä-laṣiy-u
 Yonas.M beard-Poss.3MSg DT-PerfS.shave-SM.3MSg
 ‘Yonas shaved himself./Lit. Yonas, his beard has been shaved.’

The apposition is optional, as the expression would be well-formed without it. The nominal that corresponds to the locus of the grooming event bears a pronominal suffix for the possessor that binds it to the subject argument. The subject is perceived to have both agent and undergoer argument roles simultaneously.

Similar to the passive and the anticausative, the reflexive construction can also yield ambiguous readings when there is not enough context to specify that the activity is carried out by the agent or someone else. For example, the clause in (58a) can have a passive or a reflexive reading.

- (58) a. **እታ ቀለጎ ተሐጸባ ።**
 ʔit-a qolʕa tä-ḥaṣib-a
 Det-3FSg child.Sg DT-PerfS.wash-SM.3FSg
 ‘The child has been washed./ The child washed herself.’

- b. እታ ቀልጻ ባልላ ተሓጸቢ።
 ?it-a qolʕa baʕl-a tä-ḥaʕib-a
 Det-3FSg child.Sg self-Poss.3FSg DT-PerfS.wash-SM.3FSg
 ‘The child washed herself (emphatic).’

The ambiguity can be avoided by using emphatic reflexive pronouns in order to stress that the event was carried out by the agent itself, not by someone else (58b). The emphatic reflexive pronoun is realized in subjective form indicating that it cannot correspond to a different referent.

The detransitivizing strategy is also employed to derive a reciprocal verb form. In addition to the detransitivizing process the reciprocal also involves a change in the vocalic pattern and a reduplication of consonantal roots. The reciprocal codes a different vocalic pattern than the phenomena we have discussed earlier. Table 2.11 illustrates the reciprocal verb derivation process through the conjugation of the verbal root s-b-r- ‘break’ and b-r-k- ‘bless’ for the 2MPI.

Aspect/mood	Pattern change	Reduplication
PerfH	ተሳበርኩም tā-sabär-kum	ተበረረኹም tā-bäraräk-kum
PerfS	ተሳበርኩም tā-sabir-kum	ተበረረኹም tā-bärariki-kum
Imperf	ትሳበሩ ti-sabär-u	ትበረረኹ ti-bäraräk-u
Juss	ተሳበሩ tā-sabär-u	ተበረረኹ tā-bäraräk-u

Table 2.11: Reciprocal stem derivation

As with most of the detransitivizing phenomena, the reciprocal structure is formed from a transitive verb. The reciprocalized predicate codes two arguments whose referents simultaneously initiate and undergo the affair denoted by the event. The agent and the theme/patient arguments are collapsed into one argument slot, and their merging is indicated by an obligatory plural coding of the subject pronominal suffix. The arguments coded by the reciprocalized event are expressed as subjects. The reciprocalized clause can also contain an optional reciprocal pronoun which is coreferential with the referent of the subject. The reciprocal pronoun agrees with the subject in person, gender and number, and bears an objective case marker (refer to section 2.3.2). The reciprocal phenomenon is illustrated in (59).

- (59) a. ዮናስን ሳበን ንሓድሕዶም
 Yonas-n Saba-n ni-ḥadhīd-om
 Yonas-Coord Saba-Coord obj-PRORecip-3MPI
 ተሳበሮም።
 tā-sabir-om
 DT-Recip.PerfS.break-SM.3MPI
 ‘Yonas and Saba struck each other./Lit. Yonas and Saba broke each other.’

- b. ተበራራኝዎ ብ
 tä-bärarik-om
 DT-Recip.PerfS.bless-SM.3MPI
 ‘They blessed each other.’

In (59a) the coordinated noun phrase codes a reciprocated subject which agrees in number with the reciprocal pronoun and the subject verbal suffix. The reciprocal verb can also stand alone to constitute a complete clause as in (59b) where neither a subject nor a reciprocal pronoun are overtly expressed, and thus the pronominal suffix supplies information about the unexpressed reciprocal subject.

To sum up, the different detransitivizing processes discussed above derive a verbal predicate that morphologically codes reduction of an argument from the verb’s basic argument structure. Processes such as passive, reflexive, anticausative and reciprocal reflect various types of associations of semantic arguments with grammatical functions.

Valence-increasing devices

There are two phenomena that are characterized as valence-increasing operations: the causative and the applicative. The applicative, as it is the subject of our inquiry, was introduced in chapter 1. Therefore, in this section we will only give a brief overview of the causative phenomenon. The causative construction codes a complex event composed of a causing and a caused events. In the causing event, the causer does or initiates an action or a state. In the caused event, the causee carries out the action or undergoes a change in state as a result of the action of the causer (Comrie 1989:165-166).

Tigrinya has two types of causative expressions: the periphrastic and the morphological. In the periphrastic causative, the expression of the causer’s action is introduced in an independent clause headed by the verb ገበረ *gäbärä* ‘he made’ and the caused event is embedded as its complement. Thus, this structure is syntactically biclausal, as is illustrated in (60).

- (60) a. ዮናስ [ላባ ነቲ ጥርመዝ
 Yonas Saba n-äti ṭimuzi
 Yonas Saba Obj-Det-3MSg bottle
 ከምትሰብር] ገጹሩዋ ብ
 kim-ʔi-ti-säbir-o gäyr-u-wa
 Comp-Rel-Imperf.3-break.SM.FSg-OM₁.3MSg PerfS-made.SM.3MSg-OM₁.3FSg
 ‘Yonas made Saba break the bottle./Lit. Yonas made (disposed) Saba such/so that she breaks the bottle.’

- (62) a. **የሰብር**
 yä-sibbiri =yi+ʔa >yä
 Imperf.3.Caus-break.SM.MSG Imperf.3+Caus >Imfer3.Caus
 ‘He causes to break.’
- b. **አየሰብርን**
 ʔa.yä-sibbiri-n =ʔay+yi+ʔa >ʔa.yä
 Neg-Imperf.3-Caus-Break.SM.MSG-Neg Neg+Imperf.3+Caus >Neg.Imperf.3.Caus
 ‘He does not cause to break.’

In the morphological causative, the expressions of the causer’s and the causee’s action are denoted in one predicate. The notion of a causer is marked through the causative morpheme which is directly applied to the base verb. Thus, the morphological causative is a monoclausal structure.

In conclusion, we would like to note that some verbs are obligatorily marked with either the causative or the detransitivizer marker, since their basic perfective stems are grammatically invalid forms. Some of these verbs are deponents since they have transitive applications even though they bear the detransitivizer prefix, as shown in Table 2.12.

Perf stem	active-perfective		Nominal forms	
*ṣawätä	tä-ṣawätä	he played	ṣawäta	‘play, game’
mäsäḥä	tä-mäsḥä	he ate lunch	misaḥi	‘lunch’
zäräbä	ti-zaräbä	he talked	zäräba	‘talk, speech’
säkämä	tä-säkämä	he carried	säkämi	‘weight, burden’

Table 2.12: Deponents

The roots that constitute these verbal stems are semantically meaningful because they can be applied to derive independent verb classes. For example, they are used to derive nominal forms. However, their active perfective conjugation does not have a grammatical application. The detransitivized forms of these verbs function as active perfective forms. The consonantal roots appear in nominal patterns from which it is possible to derive nouns.

With some verbs the detransitivizer codes the semantic relation of the argument that is associated with the subject, as is shown in Table 2.13. In the case of most of these verbs, the subject argument does not reflect a strong agent-like property.

Not unlike the examples given above, the verbal roots of these verbs do not have basic perfective stems. The detransitivized forms act as their active perfective forms and, in addition, they also alternate in causative form. The subject argument of verbs such as *tä-qäbälä* and *tä-läqīḥä* reflects a recipient-like property, and the

Perf stem	active-forms	active reading	Caus-form	caus-reading
*qābälä	tä-qābälä	‘he received’	?a-qābälä	‘he passed over’
läqāhā	tä-läqāhā	‘he borrowed’	?a-läqāhā	‘he lent’
ṣābäyā	ti-ṣābäyā	‘he waited’	?a-ṣābäyā	‘he made wait’
ḥag ^w äsä	ti-ḥag ^w äsä	‘he got happy’	?a-ḥag ^w äsä	‘he pleased’
rädä?ä	tä-rädi?ä	‘he understood’	?a-rädi?ä	‘he made understand’

Table 2.13: Obligatory affixes

subject argument of *ti-ṣābäyā* reflects a theme/patient-like property, while that of *ti-ḥag^wäsä* and *tä-rädi?ä* reflects experiencer-like properties.

2.5 Clause marking in Tigrinya

In Tigrinya, the basic word order is SOV (Raz 1980, Tesfay 2002, Girma 2003, Weldu 2004). The language employs extensive head marking and limited dependent marking strategies. Marked elements can leave their canonical position when they are intended to mark changes in discourse construal. Embedded clauses come before main clauses, as modifiers precede their heads. Tigrinya is a pro-drop language, which means that when the head bears pronominal markers for the arguments it controls, the clause may not contain overt expressions for these arguments.

Tigrinya is identified as a nominative-accusative language (Weldu 2004, Girma 2003). Nominal phrases that function as subjects do not bear any case marking. Moreover, there is no distinct accusative case marker that identifies objects of monotransitive clauses. Tigrinya has a very rudimentary case marking system. It only marks objects that have definite and individuated referents. When the subject and the object are indistinctly coded in terms of case, they are strictly ordered according to the basic SOV word order, as in (63a). Under these circumstances, switching the order of the subject and the object makes the clause ungrammatical, as example (63b) shows, because the ‘feminine’ agreement value of the referent coded in the subject position clashes with the ‘masculine’ agreement feature required by the subject verbal suffix. The verb obligatorily bears an agreement affix for the subject, regardless of whether it is definite or not.

- (63) a. ብዕራይ ላም ርእየ ።
 biṣray lam riʔy-u
 bull.M cow.F PerfS.see-SM.3MSg
 ‘A bull saw a cow.’

- b. ***ላም ብዕራይ ርእዩ** #
 lam biɾay riʔy-u
 cow.F bull.M PerfS.see-SM.3MSg
- c. **እቲ ብዕራይ ነታ ላም ርእዩዋ** #
 ʔit-i biɾay n-äta lam riʔy-u-wa
 Det-3MSg bull Obj-Det.3FSg cow.FSg PerfS.see-SM.3MSg-OM₁.3FSg
 ‘The bull saw the cow.’

Case marking and pronominal coding is obligatory when an object is definite, as in (63c). The determiner that codes the definite object is prefixed with the prepositional case marker **ʔ ni-**. This preposition also marks oblique expressions of a recipient, beneficiary or goal semantic role, as well as an adjunct expression of a reason or cause semantic role. The definite object ‘the cow’ is also indexed on the verb through the pronominal suffix OM₁, which codes object arguments that are lexically entailed by the meaning of the verb.

Tigrinya alternative word order positions code variations in information structure. Topics tend to occur in the sentence initial position and foci in the immediate preverbal position. As defined by Lambrecht (1998:117), a topic is the entity that is talked about. It is associated with previously mentioned or old information. Lambrecht (1998:206) defines focus as a part of a proposition expressed by a sentence that supplies new information, i.e. information which is not recoverable from the previous discourse.

In Tigrinya, when grammatical functions are coded through case and pronominal affixes, word order becomes less fixed. Case marked and pronominally indexed objects can be fronted, as in (64). The entity that corresponds to the fronted constituent is pragmatically marked, i.e. it is the main topic that the speaker wants to tell the listener about. In fact, the topicalized part is set apart by a short pause from the rest of the sentence.

- (64) **ነታ ላም እቲ ካረስታይ ገዚኡዋ** #
 n-ät-a lam ʔit-i harästay gäziʔ-u-wa
 Obj-Det-3FSg cow.FSg Det-3MSg farmer PerfS.buy-SM.3MSg-OM₁.3FSg
 ‘The cow, the farmer bought her.’

Moreover, Tigrinya is not, strictly speaking, a head-final language. When the verb carries agreement suffixes for both the subject and the object, it can precede the subject and object, as in (65).

- (65) “ደው በል” ደብሎ ኣደ
 däw bäl yi-bil-o ḥade
 still Impr.be.SM.2MSg Imperf.3.-say.SM.MSg-OM₁.3MSg one
 ካብቶም ቀለው ነቲ ሰብኣይ ።
 kab-t-om qolʿu n-ät-i säbʿay
 ABL-Det-3MPI child.Pl Obj-Det-3MSg man.Sg
 ‘One of the children tells the man to stop./ Lit. “Stop!” says one of the children to the man.’

(Hadas Ertra 2007, Issue 16, no. 236)

As noted in section 2.3.2, overt pronouns occur when they function as topics in a discourse, thus they are stressed or accented, otherwise they are not normally overtly expressed. In this case, both the subject and object NPs may be dropped altogether, leaving the verb to stand alone as a complete clause, as in (66). The arguments which are expressed through pronominal markers are retrieved from the previous discourse. In this case, the verbal affixes function as incorporated pronouns to supply the pronominal features of the argument functions required by the verb.

- (66) ገዘኡዋ ።
 gäziʿ-u-wa
 PerfS.buy-SM.3MSg-OM₁.3FSg
 ‘He bought her.’

The subject, the object or the predication in copula construction can occupy a postverbal position to code different discourse construals. This is especially common with copulative clauses. The copulative clause follows the constituent order of a basic transitive clause, i.e SOV. The copula subject is cross-referenced through agreement suffixes on the copula. The examples in (67) illustrate alternative word orders that code variation in information structure role.

- (67) a. ንሳ መምህር ኣያ ።
 niss-a mämiḥir ኣייy-a
 PRO-3FSg teacher.Sg Pres.IDcop.be-SM.3FSg
 ‘She is a teacher.’
 b. መምህር ንሳ ኣያ ።
 mämiḥir niss-a ኣייy-a
 teacher.Sg PRO-3FSg Pres.IDcop.be-SM.3FSg
 ‘She is a teacher.’

function, i.e. it is grass not something else that the farmer gave to the cattle.

- (70) a. **እቲ ሓረስታይ ነተን ከብቲ ሳዕሪ ሂቡወን ።**
 ?it-i ḥarästay n-ät-en käbti saʕri hib-u-wän
 Det-3MSg farmer Obj-Det-3FPI cattle grass PerfS.give-SM.3MSg-OM₁.3FPI
 ‘The farmer gave the cattle grass.’
- b. **እቲ ሓረስታይ ሳዕሪ ነተን ከብቲ ሂቡወን ።**
 ?it-i ḥarästay saʕri n-ät-en käbti hib-u-wän
 Det-3MSg farmer grass Obj-Det-3FPI cattle PerfS-give-SM.3MSg-OM₁.3FPI
 ‘The farmer gave the cattle grass.’

When the theme object is definite, it is obligatorily placed before the recipient object, as shown in (71a). Switching the order in which they occur brings about change of meaning, in the sense that *saʕri* ‘grass’ would be interpreted as the recipient and *käbti* ‘cattle’ as the theme (71b). In this structure, in order for the pronominal object suffix to refer to the theme object, the theme object must appear before the recipient. Thus, indexing a theme object placed after a recipient would result in an ungrammatical construction, as in (71c).

- (71) a. **እቲ ሓረስታይ ነቲ ሳዕሪ ነተን ከብቲ**
 ?it-i ḥarästay n-ät-i saʕri n-ät-en käbti
 Det-3MSg farmer Obj-Det-3FSg grass Obj-Det-3FPI cattle
ሂቡወን ።
 hib-u-wän
 PerfS.give-SM.3MSg-OM₁.3FPI
 ‘The farmer gave the cattle the grass.’
- b. **እቲ ሓረስታይ ነተን ከብቲ ነቲ ሳዕሪ**
 ?it-i ḥarästay n-ät-en käbti näti saʕri
 Det-3MSg farmer Obj-Det-3FPI cattle Obj-Det-3FSg grass
ሂቡወን ።
 hib-u-wän
 PerfS.give-SM.3MSg-OM₁.3FPI
 ‘The farmer gave the cattle to the grass.’
- c. ***እቲ ሓረስታይ ነተን ከብቲ ነቲ ሳዕሪ**
 ?it-i ḥarästay n-ät-en käbti näti saʕri
 Det-3MSg farmer Obj-Det-3FPI cattle Obj-Det-3FSg grass
ሂቡዎ ።
 hib-u-wo
 PerfS.give-SM.3MSg-OM₁.3MSg

Only one object can be indexed at a time through pronominal suffixes on the verb. When both objects are definite, the object that is considered more topical is indexed on the verb. In Tigrinya, whether a referent is animate or human does not seem to play a role in marking objects with verbal affixes. This implies that object marking is motivated by discourse, rather than by semantics.

The example given above reveals that object functions are coded through the interplay of case marking, pronominal indexation and word order. When objects are coded differently in terms of case marking, they can be displaced in order to code variation in information structure. However, when elements are ambiguous because they are equally unmarked or marked, they are constrained to appear in a fixed position.

When both objects in a ditransitive clause are indefinite, the verb does not bear a suffix for either of them (72).

- (72) እቲ ሰብኣይ ኩሉ ንገዘቡ ንድኻታት ሂቡ፡
 ?it-i säb?ay kulu gänzäb-u ni-diḵa-tat hibu:
 Det-3MSg man All-M money-Poss.3MSg Dir-poor-PI PerfH.give-SM.3MSg
 ንገዳም ክይዱ።
 ni-gägam käyd-u
 Dir-monastery PerfH.go-SM.3MSg
 ‘The man gave all his money to the poor and went to the monastery.’

The constituent that corresponds to the recipient argument bears the prepositional marker *ni-* regardless of whether it has a definite referent. When the referent of the recipient argument is a definite entity, we analyze *ni-* as a grammatical case, as in (70) and (71). Since definite recipient objects can also be cross-referenced through pronominal suffixes, we take this as evidence that they are core objects. In Tigrinya, prepositions that consist of a single syllable such as *ni-* and *bi-* are directly cliticized to a noun (refer to chapter 8 for further discussion).

Like recipient objects, objects with semantic roles such beneficiary, locative and instrument can also be coded through object pronominal suffixes in Tigrinya. However, these objects do not employ the same form of suffixes as theme and recipient objects. Since these objects correspond to inherently oblique semantic roles, they are distinguished from objects that are semantically entailed by the meaning of the base verb by means of pronominal suffixes. They are coded by suffixes which are composed of the preposition *-li* plus the gerundive person, gender and number suffixes. For example, *-la* is composed of *-li* and *-a*, which is a 3FSg agreement suffix, as shown in (73).

- (73) a. ዮናስ ብግንካይ በሊዑ።
 Yonas bi-manka-y bäliʕ-u
 Yonas spoon-Poss.1Sg PerfS.eat.SM.3MSg
 ‘Yonas ate with my spoon.’

- b. የሃሳስ ነታ ማንካይ በሊዮላ ብ
 Yonas n-ät-a manka-y bäliŋ-u-la
 Yonas Obj-Det-3FSg spoon-Poss.1Sg PerfS.eat.SM.3MSg-OM₂.3FSg
 ‘Yonas ate with my spoons.’

The clause in (73a) codes a transitive verb *bäli* ŋ-u ‘eat’ which is inherently subcategorized for both an agent and a theme argument. The agent is expressed as subject, but the expression of the theme argument is omitted. This clause also contains a nominal which is marked by the instrumental prepositional particle *bi-*. The verb bears a pronominal suffix for the subject only. In (73b), the instrumental argument is topicalized through the applicative coding, thus the verb bears the applicative object suffix *la-* for it. A detailed description of applicative constructions can be found in chapters 4, 5 and 6.

2.6 Concluding remarks

In this chapter, we reviewed some of the basic nominal, verbal and clause structures of Tigrinya. We saw that Tigrinya is a predominantly head-final language with respect to the organization of constituents both in nominal phrases and basic clauses. The language employs extensive number, gender and person agreement. Determiners, quantifiers and adjectives also agree with the head noun in number and gender. Nouns can bear pronominal suffixes for a possessor, and verbs are obligatorily marked with subject pronominal suffixes; however, object marking depends on the discourse salience of referents. A verb in Tigrinya can be morphologically very complex. The root-pattern conjugation system is employed to derive and inflect verbs for tense-aspect and mood. In addition, basic verb forms can also bear derivational suffixes that indicate changes in argument relations. The basic order of elements in a clause is SOV; however, this order is violated in different discourse contexts.

CHAPTER 3

LFG basics

3.1 Introduction

This chapter will present a short introduction to Lexical-Functional Grammar (LFG). LFG was developed by Joan Bresnan and Ronald M. Kaplan in the 1970's. Bresnan, a linguist, and Kaplan, a computational linguist with a background in psychology, were interested in developing a model of a grammar that combines psychological plausibility and computational tractability (Sells 1985). The first description of this theory appeared in a book entitled *The Mental Representation of Grammatical Relations*, edited by Bresnan (1982b). The basic account of the formalism is laid out in chapter 5 of this book, a contribution by Kaplan and Bresnan (1982). The formalism has evolved considerably since its inception. Currently, it is used for the analysis of various well-known linguistic phenomena and for the description of numerous languages. Some important current works are Bresnan (2001), Dalrymple (2001), Falk (2001) and Kroeger (2004).

LFG is a surface-oriented declarative approach, thus it does not posit an intermediate level of syntactic representation like the deep-structure in the Government and Binding Theory. Instead, different levels of linguistic information are given as parallel representations. The representations are related to one another by functional correspondences. Thus, LFG does not involve movement of constituents or transformations to describe a sentence. In LFG, a grammatical analysis of an utterance is subject to various constraints that exist at the different levels of representation. A

well-formed sentence is licensed when all the interacting constraints are satisfied. As its name indicates, LFG puts strong emphasis on the lexicon and on syntactic functions. A standard LFG analysis of a sentence consists of a constituent structure (c-structure) which gives the phrase organization of the surface form of a sentence, and a functional structure (f-structure) which encodes the grammatical functions assumed by significant constituents of the sentence. In addition, the f-structure also contains a representation of the predicate's argument structure (a-structure). The a-structure represents the subcategorizable arguments of a predicator such as a verb. Normally, the a-structure is not given as a separate level of representation. It is given within the f-structure. C-structure, f-structure and a-structure are the most basic representations, and also the most researched ones. LFG may also include other levels of representation such as semantic structure (s-structure) (Dalrymple 2001) and discourse structure, also called information structure (d-structure or i-structure) (Butt and King 1996, King 1997, Choi 1999).

In this chapter we will lay out the basic concepts of LFG, focusing on aspects that will help us to lay the groundwork for later discussions. This chapter will be organized as follows. In section 3.2, we will discuss the main facets of the c-structure representation, c-structure rules, c-structure trees and X' theory. This will be followed by a discussion of f-structure in section 3.3 which will briefly present functional annotations, c-structure and f-structure correspondences, well-formedness conditions and grammatical functions in LFG. Finally, in section 3.4 we will outline discourse/information structure. In the course of our discussion, we will mainly cite examples from English, and some examples from Tigrinya when necessary.

3.2 C-structure

The c-structure is a representation of the phrase structure configuration of the surface form of a sentence. It provides information about the syntactic category of words, phrasal grouping and linear order of constituents. Since languages reflect great variation in their surface organization, the c-structure codes language-specific information such as variation in phrase categories and word order. LFG uses conventional phrase structure trees which are determined by a context-free phrase structure grammar. These are well-formed labeled bracketings that reflect the superficial arrangement of words and phrases into sentences. It codes precedence and dominance relations among constituents. The c-structure rules used in LFG are of

the sort given in (74). These rules can describe a simple clause in English.

(74) *C-structure rules*

S → NP VP

VP → V NP

NP → (DET) N

The parentheses surrounding DET indicates that this category is not obligatory. Thus the third line in (74) is a rule schema, an abbreviation of two c-structure rules: NP → N and NP → DET N. In (75), the Kleene star operator ‘ * ’ indicates that there may be zero or more PPs.

(75) VP → V (NP) PP*

Such devices make it possible to abbreviate a large number of phrase structure rules.

Phrase structure trees must be licensed by the phrase structure rules of a language in order to be grammatical structures. For example, the c-structure tree (76) for the English sentence *Yonas ate the banana*, is licensed by the rules given in (74).

(76) *Phrase structure tree*

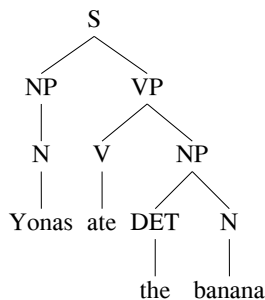

The c-structure tree codes two types of information about the categories. Meaning bearing words such as nouns (N), verbs (V), adjectives (Adj), prepositions (P)

and arguably adverbs (Adv) are identified as lexical categories. These words head the phrases designated by them, for example, N is the head of NP, V is the head of VP, etc. These phrases are projections of their lexical heads. The head determines the properties of the phrase it projects since the properties of the head project or percolate to the entire phrase it is head of. In addition to the lexical categories, linguistic theories such as LFG assume the existence of functional categories that play a role in organizing the syntax of some languages (Dalrymple 2001:53). Some of the widely used functional categories are: determiners (DET), inflectional units (I) and complementizers (C), which head functional projections such as DP, IP and CP, respectively. Bresnan (2001:99) states that “functional categories are specialized subclasses of lexical categories which have a syncategorematic role in the grammar (such as marking subordination, clause type or finiteness).” For example, the functional category I is identified as being the organizing element of the syntax of languages such as English (Falk 1984), Tagalog (Kroeger 1993) and most Scandinavian languages (Börjars et al. 1999), among many others. In the Scandinavian languages, the category I is occupied by finite verbs and auxiliaries which tend to appear in a special clause position known as the second position. Hence, since this functional category is the head of a finite clause, the sentence itself is identified as IP in these languages. Bresnan (2001:100) also identifies the functional category determiner (DET) as the head of the functional projection DP (determiner phrase) in English. The simplified phrase structure rules in (74) are modified in (77) in order to include the functional projections IP, I' and DP of the functional categories I and DET. These rules license the c-structure representation in (78) (page 75) for the English sentence *The boy is eating a banana*.

(77) *IP category: c-structure rules*

$$\begin{aligned} \text{IP} &\rightarrow \text{DP} \quad \text{I}' \\ \text{I}' &\rightarrow \text{I} \quad \text{VP} \\ \text{VP} &\rightarrow \text{V} \quad \text{NP} \\ \text{DP} &\rightarrow \text{DET} \quad \text{NP} \\ \text{NP} &\rightarrow \text{N} \end{aligned}$$

(78) *IP category: tree representation*

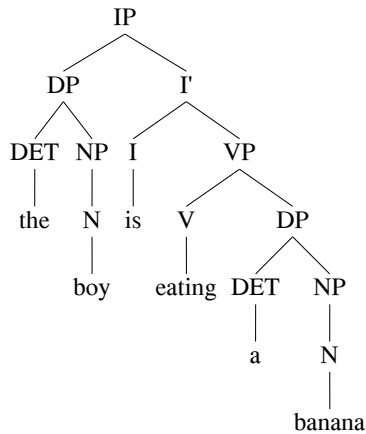

Some languages lack the functional category DET, for example, Hebrew (Falk 2001:38), and also Amharic, which like Hebrew marks definiteness through inflectional affixes on head nouns and adjectives.

3.2.1 X' theory

The regularities and relations among categories is captured by X' theory. The idea that all phrases have heads of the same category, i.e. N heads an NP, I heads an IP, V heads a VP, etc., is one of the powerful assumptions of this theory. As Bresnan (2001:120) points out, X' theory posits an internal structure to the category labels that allows to capture their relations. For example, V and P are assumed to be categories with transitive properties because of their ability to take direct object complements, whereas N and A do not take complements. In contrast, V and A are assumed to be categories with predicative properties because of their ability to take an external subject of predication, but they cannot function as arguments themselves. Furthermore, the phrase categories reflect a regularity where a phrase on the left hand side of the rule, let us say XP (X is a variable name that can be replaced with I, N, D, V, A, Adv and so on) expands into X which is the head of the phrase, and another category YP (Y is a variable name for a category different than X) on the right hand side of the rule. The phrase YP is identified as a complement, and it is the sister of the head X. The generalized phrase structure rule is shown in (79).

(79) $XP \rightarrow X \ YP$

This rule states that every phrase branches into a head and a complement. However, this is not a complete specification of the theory, since with this we can only capture the regularity in particular types of phrases. A more powerful phrase structure would be one that applies to all types of phrases regardless of their category, a kind of universal one. In order to realize this notion, X' theory decomposes c-structure categories into three structural levels - 0, 1, 2 - known as bar levels. A lexical or functional category is identified as the 0 bar level written as X^0 or just X, and it has phrase projections of 1 bar level X' and two bar level X'' . The X' and X'' projections are also identified as the intermediate and the maximal projections. The decomposed c-structure categories reflect a pattern where X^0 is the c-structure head of X' , and X' is the c-structure head of X'' , as in (80) (Bresnan 2001:121).

(80) a. $XP \rightarrow YP, \ X'$
 b. $X' \rightarrow X^0, \ ZP$

In addition to the complement (ZP in 80b), in the analyses above we also identify a specifier position, the YP in (80a), as the sister of the X' projection dominated by the maximal projection XP. The comma separating the sisters indicates that the categories are not linearly ordered. This is schematically represented in (81) (Dalrymple 2001):

(81) *X' theory*

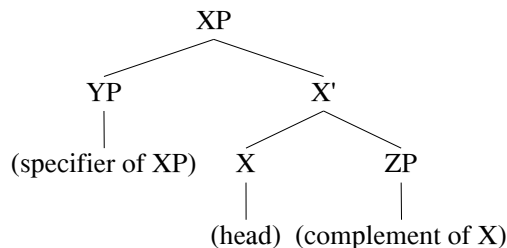

The phrase configuration of adjuncts is described either by adjoining an intermediate projection (X') with another intermediate projection (82a), or a maximal projection (XP) with another maximal projection (82b) (Bresnan 2001).

- (82) a. $X' \rightarrow X', YP^*$
 b. $XP \rightarrow XP, YP^*$

In this way, an adjunct (YP^*) is analyzed as a sister of X' dominated by X' , or a sister of XP dominated by XP .

3.2.2 Endocentric and exocentric categories

The notion that X is a head of the maximal projection XP and of the medial or nonmaximal projection X' is known as endocentricity. Highly configurational languages such as English employ the endocentric pattern where their maximal phrase XP has a c-structure head. These languages obey the principles of X' theory.

However, there are also languages which have a category which is not a headed maximal projection. These languages do not reflect the configuration assumed in X' theory, and are identified as having an exocentric pattern. Therefore, LFG allows an exocentric S which is a nonprojective category, as it lacks a fixed categorial head like the I which heads the endocentric category IP (Bresnan 2001:110). These languages use morphological means such as case and/or pronominal marking to encode grammatical functions. The exocentric structure is a flat clausal structure where S dominates any kind of lexical or phrase category such as NP , A or V . The exocentric structure is admitted by the following c-structure schemata (83) (Falk 2001:51).

- (83) a. $S \rightarrow X^*$
 b. $S \rightarrow XP, X^0$
 c. $S \rightarrow NP, XP$

Theoretically, the S rule in (83a) can dominate any number of lexical categories, and this exocentric pattern is thought to exist in languages which are nonconfigurational in the radical sense. For example, Warlpiri is assumed to reflect this structure (Bresnan 2001:6). In these languages, the asymmetry between arguments is captured at a-structure and f-structure levels (Bresnan 1994). The S category in (83b) is used in the analysis of languages which lack the category VP , and display a flat structure, while exhibiting an endocentric structure in other categories, e.g. in their nominal category. Languages such as Malayalam (Falk 2001:50), Urdu (Butt and King 2007) and Turkish (Gongordo and Oflazer 1995:302) reflect this pattern. The S category in (83c) describes languages which distinguish the subject and predicate positions such as Tagalog (Kroeger 1993:10-11) and Welsh (Sadler 1997, 1998),

where the predication phrase *XP* can be filled with an *NP*, a *VP*, an *AP* or a *PP*. These languages combine endocentric and exocentric structures.

We assume that Tigrinya uses the exocentric category *S* (83b) as it lacks strong evidence for the existence of a *VP* category. However, since the language uses independent determiners to express definiteness, and has a minimal phrase headed by a noun, we assume its noun phrase is organized by the endocentric *XP*. For example, the sentence in (84) is admitted by the c-structure tree in (85).

- (84) የኖስ ነታ ባናና በሊዑዋ ።
 Yonas n-ät-a banana bäliŷ-u-wa
 Yonas.MSg Obj-Det-3FSg banana.Sg PerfS.eat-SM.3MSg-OM₁.3FSg
 ‘Yonas ate the banana.’

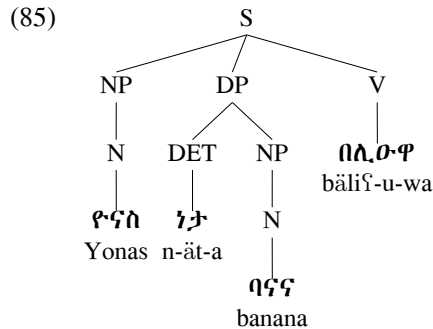

In the following section, we will present a brief overview of how LFG motivates the correspondence between c-structure and f-structure.

3.3 F-structure

F-structure is a representation of grammatical features and functions. It is assumed to be cross-linguistically comparable since the notion of functions adopted in LFG accords with the traditional notions of grammatical functions such as subject, object, complement and adjunct. LFG is also suitable for the description of typologically unrelated languages because the sort of grammatical functions employed in this theory allows us to capture cross-linguistic generalizations in terms of argument-function realization, despite the different syntactic expressions they use to code grammatical functions. In LFG, a sentence is assumed to reflect an abstract functional syntactic organization which is modeled by the f-structure. For

example, the verb functions as a predicator (PRED), an NP with certain properties functions as a subject (SUBJ), another with different properties functions as an object (OBJ) and a PP with certain properties functions as an oblique (OBL) and another one as an adjunct (ADJ), etc. A brief sketch of grammatical functions is given in section 3.3.3.

The f-structure is represented by an Attribute-Value Matrix (AVM). It is defined as a mathematical function from attributes to values (Bresnan 2001:47; Dalrymple 2001:30). For example, the f-structure in (86) contains four attributes, PRED, PERS, NUM and GEND, vertically listed on the left side.

$$(86) \begin{bmatrix} \text{PRED} & \text{'boy'} \\ \text{PERS} & 3 \\ \text{NUM} & \text{sg} \\ \text{GEND} & \text{masc} \end{bmatrix}$$

These attributes can either have features such as 3, *sg* and *masc*, or a semantic form such as 'boy' as values. The semantic form is enclosed in single quotes in order to indicate that it is instantiated to a unique value for each use of the lexical entry that it is associated with (Dalrymple 2001:104). An attribute can also take a subsidiary f-structure as its value. For example, the f-structure in (86) can be given as a value of the function attribute SUBJ in a larger f-structure, as in (87).

(87) F-structure of *The boy robbed a bank*

$$f_1 \begin{bmatrix} \text{SUBJ} & f_2 \begin{bmatrix} \text{PRED} & \text{'boy'} \\ \text{PERS} & 3 \\ \text{NUM} & \text{sg} \\ \text{GEND} & \text{masc} \\ \text{DEF} & + \end{bmatrix} \\ \text{PRED} & \text{'rob(SUBJ, OBJ)'} \\ \text{TENSE} & \text{past} \\ \text{OBJ} & f_3 \begin{bmatrix} \text{PRED} & \text{'bank'} \\ \text{NUM} & \text{sg} \\ \text{DEF} & - \end{bmatrix} \end{bmatrix}$$

The attributes and values represent the grammatical functions and features of the sentence. Thus the f-structure encodes morphosyntactically marked functional information. Grammatical information that belongs to the same grammatical category (e.g. agreement) may flow from different parts of the syntactic structure

to form a unified f-structure. For this reason, an f-structure is viewed as a set of attribute-value features in which the merging of the elements is performed by a mathematical operation known as unification, as shown in (88).

(88) Unification

$$\begin{array}{ccc}
 \text{a. } \left[\begin{array}{cc} \text{A} & \text{b} \\ \text{C} & \text{d} \end{array} \right] & & \text{b. } \left[\begin{array}{cc} \text{C} & \text{d} \\ \text{E} & \left[\begin{array}{cc} \text{F} & \text{g} \end{array} \right] \end{array} \right] \\
 & & \text{c. } \left[\begin{array}{cc} \text{A} & \text{b} \\ \text{C} & \text{d} \\ \text{E} & \left[\begin{array}{cc} \text{F} & \text{g} \end{array} \right] \end{array} \right]
 \end{array}$$

The unification operation combines consistent features of the attribute-value pairs in (88a) and (88b), and makes them identical by merging them into a new structure, as in (88c). The unified structure is the union set which contains all the information from the unified feature structures, but no additional information. However, the operation would fail if an attribute is specified for two different values. For this reason, unification accounts for ungrammaticality that results from incompatible information. For example, if a SUBJ is specified for both [NUM sg] and [NUM pl], this will not unify since the SUBJ is inconsistently described. LFG ensures grammaticality by constraining the f-structure by means of well-formedness conditions, which will be discussed in the following section.

3.3.1 Well-formedness conditions on f-structures

LFG posits well-formedness conditions on f-structures that rule out ungrammatical sentences. The most important conditions are: *completeness*, *coherence* and *uniqueness/consistency*. The completeness condition ensures that the arguments that are selected by a certain predicator are present in the f-structure. For example, the PRED in the main f-structure (f_1) in (87) has a semantic form ‘rob’ which is subcategorized for two arguments, SUBJ and OBJ. The f-structure is constrained to contain both of these arguments. Thus, the ungrammaticality of the string **The boy robbed* is explained by its being incomplete.

The coherence condition checks that no superfluous arguments emerge in the f-structure, i.e. it filters arguments that are not selected by the predicator. For example, it will rule out the sentence **The boy sleeps the sofa* as ungrammatical, since *sleep* only requires one governable argument realized as SUBJ. This is stated by the value of the PRED feature in the main f-structure in (89). Since the OBJ argument is superfluous, the f-structure is ill-formed.

(89) non-coherent f-structure **The boy sleeps the sofa*

SUBJ	PRED	‘boy’
	PERS	3
	NUM	sg
	GEND	masc
	DEF	+
PRED	‘sleep⟨SUBJ⟩’	
TENSE	pres	
OBJ	PRED	‘sofa’
	NUM	sg
	DEF	+

The completeness and coherence conditions concern governable functions only, i.e. arguments that are required by a predicator. If *sofa* is expressed as the object of a preposition as in *The boy sleeps on the sofa*, the f-structure would not fail since the prepositional expression *on the sofa* is analyzed as a non-governable ADJ. Moreover, if the sentence contained a modifying adjunct, for example, *today* as in *The boy sleeps on the sofa today*, the f-structure will be coherent, as adjuncts are non-governable functions. This is shown in (90).

(90) Adjuncts ‘The boy sleeps on the sofa today.’

SUBJ	PRED	‘boy’
	PERS	3
	NUM	sg
	GEND	masc
	DEF	+
PRED	‘sleep⟨SUBJ, OBL _{on} ⟩’	
TENSE	pres	
ADJ	}	PRED ‘on⟨OBJ⟩’
		OBJ
		PRED ‘sofa’
		NUM sg
		DEF +
		PRED ‘today’

The attribute ADJ has a set value, enclosed inside curly brackets. LFG employs sets to represent structures that may contain an unbounded number of members. For example, a sentence can contain more than one modifying adjunct such as adjectives

and adverbs.

The uniqueness condition specifies that an argument must have a unique value. Bresnan (2001:47) states that the uniqueness condition emanates from the nature of the f-structure, which is also assumed to be a function in the mathematical sense. This means that unification, i.e. the operation by which f-structures are merged together, requires an f-structure attribute to have a unique (single) value. In other words, its value must be consistent (Falk 2001:64). The uniqueness condition does not rule out two different attributes that have the same values; however, a single attribute cannot have different values. For example, the f-structure representation of the sentence *They sleeps.* is inconsistent since NUM has conflicting values, sg and pl, as shown in (91).

- (91) Inconsistent f-structure
- $$\left[\begin{array}{ll} \text{PRED} & \text{'sleep(SUBJ')} \\ \text{TENSE} & \text{pres} \\ \text{SUBJ} & \left[\begin{array}{l} \text{PRED 'they'} \\ \text{NUM sg/pl} \end{array} \right] \end{array} \right]$$

The verb will require its subject's number to be singular, whereas in the noun phrase the subject's number is plural. Thus, these conflicting information will not unify.

In the following section, we will discuss how the two levels of representation, c-structure and f-structure, are related to each other.

3.3.2 C-structure and f-structure correspondence

The c-structure and the f-structure are related by functional correspondence. Their correspondence is achieved through functional annotation which creates parallel and simultaneous representations to license an analysis of a sentence. This is based on the notion that c-structure nodes have a relation to parts of f-structures. Their correspondence is expressed through functional schemata that annotates c-structure nodes with the functional information that it bears. The formal system of annotation is illustrated in (92). We illustrate the annotation schema by annotating the endocentric rule for English which was given in (92) (Dalrymple 2001:126; Falk 2001:73).

(92) Functional annotation

IP	→	DP	I'
		(↑ SUBJ)=↓	↑ = ↓
I'	→	I	VP
		↑ = ↓	↑ = ↓
VP	→	V	NP
		↑ = ↓	(↑ OBJ)=↓
DP	→	DET	NP
		↑ = ↓	↑ = ↓
NP	→	N	
		↑ = ↓	

The upward pointing arrow \uparrow refers to the f-structure that belongs to the mother node, and the downward pointing arrow \downarrow refers to the f-structure that is associated with the daughter node. For example, the annotation $(\uparrow \text{SUBJ})=\downarrow$ specifies that the SUBJ in the f-structure of the mother node, i.e. the IP, is identical to the f-structure of the daughter node, i.e. the NP specifier of IP. Recall that the endocentric pattern abides by the principles of X' theory. Thus, the phrase configuration is also reflected in the annotation of the rules. The heads of the phrases (e.g. the functional head I and the lexical head V) are annotated with $\uparrow=\downarrow$. This expresses the notion that a phrase and its head is associated with the same f-structure. In addition, co-heads of functional categories (e.g. the VP complement of I) also bear the $\uparrow=\downarrow$ annotation to express the fact that they are also f-structure co-heads. The complement of a lexical category (e.g. V), i.e. NP, is annotated with the $(\uparrow \text{OBJ})=\downarrow$.

In addition to the functional information annotated on the phrase structure rules, information about grammatical features such as tense, definiteness and agreement categories is annotated on the lexical entries. In LFG, the lexicon plays a central role in the analysis of a sentence. For instance, the lexical entry for a verb codes its subcategorizational frame given in the form of a predicate-argument structure. The subcategorization frame is for grammatical functions such as subject (SUBJ), primary object (OBJ), secondary object (OBJ_θ) and oblique (OBL_θ). Function-changing phenomena such as the passive and the applicative are accounted for by generalizations observed in the lexicon. These phenomena are handled via lexical rules that describe changes in the mapping from a-structure to f-structure (a de-

tailed discussion of a-structure is provided in chapter 7.5.1). Bresnan (1982a) notes that many of the statements that are made by transformational rules in the transformational paradigm are formulated as lexical rules in LFG. In this strong lexicalist theory words are considered to be atoms, that is they can neither be created nor can they be analyzed by syntactic rules. This is stated as the *Lexical Integrity Principle* (93):

(93) *Lexical Integrity Principle* (Bresnan 2001:93)

Morphologically complete words are leaves of the c-structure tree and each leaf corresponds to one and only one c-structure node.

Therefore, the lexical entries are described in their full inflectional forms prior to the operation of syntactic rules and are associated with the functional schemata that generate their f-structure. The functional schemata for the lexical entries of the words in the English sentence *Yonas ate the banana.* are shown in (94).

(94) Lexical entries

ate	V	(↑ PRED)='eat'⟨ (↑ SUBJ), (↑ OBJ)⟩ (↑ TENSE)=past
Yonas	N	(↑ PRED)='Yonas' (↑ NUM)= sg (↑ DEF)=+
the	DET	(↑ DEF)=+
banana	N	(↑ PRED)='banana' (↑ NUM)= sg

Meaning-bearing words such as *ate*, *Yonas* and *banana* are lexical heads, and thus they contribute the PRED features which express their semantic forms in addition to grammatical features such as tense, number and gender. The semantic form of the verb *ate* is a complex form which also contains information about the type of syntactic arguments that the verb is subcategorized for, as in 'eat'⟨(↑ SUBJ, ↑ OBJ)⟩'. Functional categories such as DET provide information on definiteness.

The lexical entries in (94) and the c-structure rules in (92) admit the annotated tree in (95) to model the analysis of the English sentence *Yonas ate the banana.*

(95) Annotated tree

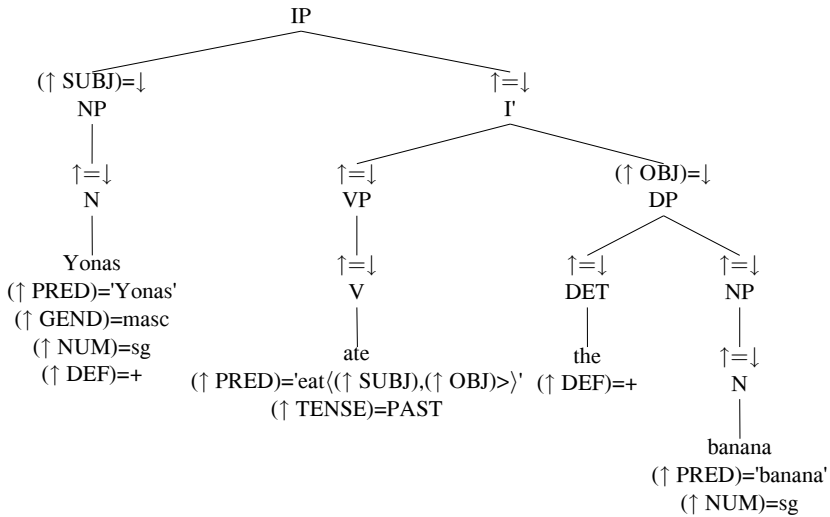

The up and down arrows in the functional annotations of the c-structure are known as metavariables since they are instantiated by variables leading to a set of functional equations. We will illustrate this point in a partial tree (96) by assigning number labels 1 to the maximal projection IP, 2 to the specifier daughter NP, 3 to the second daughter I' and 4 to the N daughter of NP.

(96) Labeled c-structure nodes

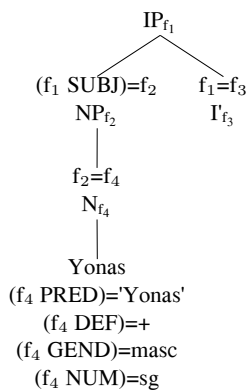

The up arrows at a node are instantiated by the variables that are associated with the node that immediately dominates it, and the down arrows at a node are instantiated by the variables that are associated with the node itself. Thus, f_1 represents the f-structure corresponding to *IP* (i.e. the mother node), and f_2 and f_3 represent the f-structures corresponding to *NP* and *I'* (i.e. the nodes immediately dominated by *IP*), respectively. Likewise, f_4 refers to the f-structure of the node immediately dominating the terminal node with the lexical item that bears the f-structure annotations. A set of such equations is known as a *functional description* (f-description). The equations in (97) constitute the f-description of the subject *NP* through the instantiations given in (96).

- (97) f-description
 $(f_1 \text{ SUBJ})=f_2$
 $f_1=f_3$
 $f_2=f_4$
 $(f_4 \text{ PRED})='Yonas'$
 $(f_4 \text{ DEF})=+$
 $(f_4 \text{ GEND})=\text{masc}$
 $(f_4 \text{ NUM})=\text{sg}$

The f-description in (97) is used to build a partial f-structure representation in (98).

- (98) From f-description to f-structure
- $$f_{1,3} \left[\begin{array}{c} f_{2,4} \left[\begin{array}{cc} \text{PRED} & \text{'Yonas'} \\ \text{NUM} & \text{sg} \\ \text{GEND} & \text{masc} \\ \text{DEF} & + \end{array} \right] \\ \text{SUBJ} \end{array} \right]$$

Since the functional equation $f_2=f_4$ expresses that f_2 and f_4 are the same f-structure, *NP* inherits its f-structure from *N*. This shows that the mapping from c-structure to f-structure is many-to-one, since both nodes, *NP* and *N*, are mapped to the same f-structure. Let us now complete the instantiation procedure of the annotated tree representation in (95) in (99).

(101) F-structure ‘Yonas ate the banana.’

$$\begin{array}{l}
 f_{1,3,5,6} \left[\begin{array}{l}
 \begin{array}{l}
 f_{2,4} \left[\begin{array}{l}
 \text{PRED} \quad \text{'Yonas'} \\
 \text{NUM} \quad \text{sg} \\
 \text{GEND} \quad \text{masc} \\
 \text{DEF} \quad +
 \end{array} \right] \\
 \text{SUBJ}
 \end{array} \\
 \text{PRED} \quad \text{'eat(SUBJ, OBJ)'} \\
 \text{TENSE} \quad \text{past} \\
 \begin{array}{l}
 f_{8,9,10,11} \left[\begin{array}{l}
 \text{PRED} \quad \text{'banana'} \\
 \text{NUM} \quad \text{sg} \\
 \text{DEF} \quad +
 \end{array} \right] \\
 \text{OBJ}
 \end{array}
 \end{array} \right]
 \end{array}$$

The f-structure representation tends to be more similar crosslinguistically than the c-structure, since, in general, languages display great variability in their phrase configurations, but they may encode similar syntactic functions such as SUBJ, OBJ and ADJ. In order to illustrate this, we are going to provide an f-structure analysis of the Tigrinya sentence in (84), repeated here as (102).

(102) የኖስ ነታ ባኖኖ በሊዑዋ ።
 Yonas n-ät-a banana bäliŋ-u-wa
 Yonas.MSg Obj-Det-3FSg banana.Sg PerfS.eat-SM.3MSg-OM₁.3FSg
 ‘Yonas ate the banana.’

We use the exocentric structure to create a c-structure representation in Tigrinya, as was shown in (85). Tigrinya employs word order, dependent marking and head marking to code grammatical functions. In Tigrinya, the OBJ is not strictly required to appear adjacent to the verb since the SUBJ and the OBJ can switch positions when the NPs that are associated with them bear overt marking, and also when they are marked on the verb by means of pronominal suffixes. Constituents realizing grammatical functions can also be dropped altogether from the clause when the verb bears suffixes to code them (refer to section 2.5). Therefore, grammatical functions do not need to be configurationally encoded as in the case of English. The c-structure rules in (103) can account for a simple sentence in Tigrinya.

(103) Tigrinya annotated c-structure rules

S	→	XP*,	V
		{ (↑ SUBJ)=↓ }	↑ = ↓
		(↑ OBJ)=↓ }	
DP	→	D	NP
		↑ = ↓	↑ = ↓
NP	→	N	
		↑ = ↓	

At phrase level, Tigrinya is considered to be a free word order language. As can be seen from the rule above, shuffling is encoded by the comma which is placed between the maximal projection XP and the V constituent. In addition, as noted earlier, we do not posit a VP category in the language since there is no evidence for the configuration of a subject (specifier) and a complement position. The XP constituent is a maximal projection which universally applies for phrase projections such as NP, DP, AP, POSSP, etc. Subjects and indefinite objects are unmarked for case. Subjects are obligatorily marked on the verb through pronominal affixes, but only definite objects bear case marking and are cross-referenced on the verb. When objects bear overt marking, they may be alternatively reordered with respect to the other elements in order to express pragmatically marked meanings. This grammatical property is expressed by means of a constraint that prohibits the object from preceding the subject, i.e. (SUBJ) <h (OBJ) where '<h' means subjects precede objects. The S rule in (103) may thus be expanded to include the constraints in (104).

$$(104) \quad (\uparrow \text{OBJ})=\downarrow \\
\{ \sim(\downarrow \text{DEF})=+ \\
\sim(\downarrow \text{CASE}) \\
\sim(\downarrow \text{OBJ}) <h (\uparrow \text{SUBJ}) \\
| (\downarrow \text{DEF})=+ \\
(\downarrow \text{CASE})=_{c} \text{obj} \\
(\downarrow \text{AGR})=_{c}+ \}$$

The notation { ... | ... } represents disjunction. The first disjunct in the rule expresses that non-case marked and non-definite objects cannot precede the subject. The second disjunct specifies that definite objects are obligatorily case marked. This rule expresses that globally all elements are not linearly ordered. It requires the object and subject to occur in a fixed position under the condition that the object is indefinite and is not case marked. Moreover, the last two constraining equations refer to requirement that freely moving objects bear the objective case and be definite. A constraining equation requires a particular feature to be present, and it is defined by subscripting the letter *c* to the equal sign. For example, the equation $(\downarrow \text{CASE})=_{c} \text{obj}$ specifies that the object must bear objective case marking.

In (105), we illustrate the functional schemata associated with the lexical entries for the sentence in (102).

(105) Lexical entries

በኢዮታ -bäliŋuwa	V	(↑ PRED)='eat' ((↑ SUBJ), (↑ OBJ))' ((↑ SUBJ PRED)='PRO') (↑ SUBJ GEND)=masc (↑ SUBJ NUM)=sg (↑ SUBJ PERS)=3 ((↑ OBJ PRED)='PRO' ~ (↑ OBJ PRED)='PRO') (↑ OBJ DEF)= _c +) (↑ OBJ GEND)=f (↑ OBJ NUM)=sg (↑ OBJ PERS)=3 (↑ ASPECT)=PerfS
ዮናስ -Yonas	N	(↑ PRED)='Yonas' (↑ GEND)=masc (↑ NUM)= sg (↑ DEF)=+
ነጎሳ -näta	DET	(↑ SPEC DET PRED)='näta' (↑ DEF)=+ (↑ CASE)= _c obj (↑ GEND)=f (↑ NUM)=sg (↑ PERS)=3
ባናና -banana	N	(↑ PRED)='banana' (↑ NUM)= sg

The lexical entries for the Tigrinya sentence are richer morphologically than the entries for the equivalent English sentence given in (94). In addition to the number and types of arguments, the lexical entry for the Tigrinya verb specifies that both the object and the subject can be pro-dropped through the optional equations ((↑ SUBJ PRED)='PRO') and ((↑ OBJ PRED)='PRO'). This is because both the subject and the object are pronominally marked on the verb *bäliŋu-wa* 'he ate it (F)'. Pronominal markers give gender, number and person agreement values. In addition, the object is constrained to be definite when it is coded on the verb. However, since constraining equations will require the object NP to be overtly realized, we employ the constraint (~ (↑ OBJ PRED)='PRO') in order to specify that the pro-drop phenomenon is exempted from the requirement. The determiner *nät-a* 'obj-det-3FSg' is marked with the objective case, and it is also specified for gender, number and person. Common nouns such as *banana* are specified for number agreement, but not for gender or definiteness. Gender and definiteness are assigned by the determiner. Now we will use the annotated rule (103) and the lexical entries (105) to show the correspondence between the c-structure and f-structure (106).

(106) Annotated tree

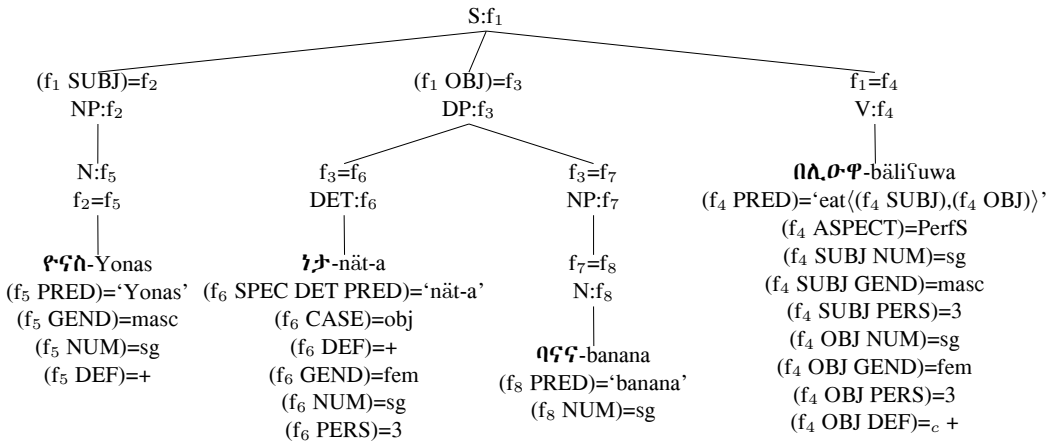

The f-structures representation for (102) is given in (107).

(107) F-structure for 'Yonas näät-a banana bäliſuwa'

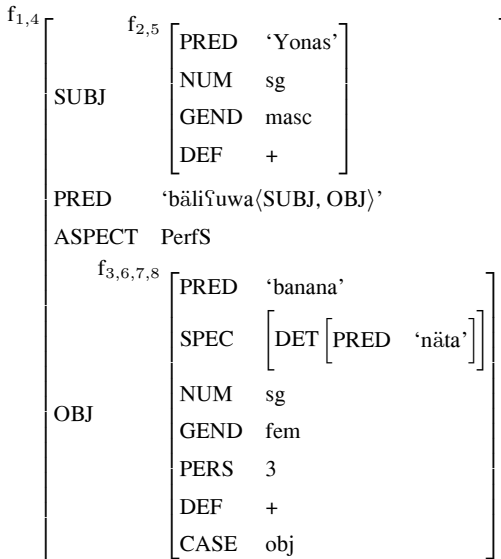

Even though Tigrinya and English have very different phrasal organization, their f-structure representations are nevertheless comparable, as we can see from the English f-structure in (101) and the Tigrinya f-structure in (107). Tigrinya is morphologically richer than English, thus grammatical functions need not be

coded through structural configuration. Certain grammatical features that are not expressed in English are given as morphological features in Tigrinya. For example, the definite article is not specified for gender, number and case in English, whereas, in Tigrinya, it is specified for such features.

Grammatical functions such as SUBJ and OBJ play a central role in LFG. In the following section, we will briefly review the grammatical function categories that are assumed in LFG.

3.3.3 Grammatical functions

Grammatical functions (GFs) are characterized by abstract internal coherence which is not definable in terms of phrase configurations and semantic roles (Falk 2001:57). For this reason GFs are posited as theoretical primitives in LFG, as their function cannot be derived from theoretical constructs such as phrase structure configuration and semantic roles. Andrews (1985:62) states that grammatical functions such as SUBJ and OBJ are functional relations that a noun phrase possesses by virtue of the role it plays in a sentence. A subject can be coded by different syntactic or morphological expressions in different languages. In English, it is configurationally coded as the specifier of the endocentric clause, i.e. IP, as we noted in section 3.2.2. In Norwegian, the same position, i.e the specifier, is reserved for topics, and the subject can occupy this position when it coincides with a topic discourse function. Otherwise, if there are other topicalized elements, the subject will occur after the verb since the verb is constrained to appear in second position in the clause. In languages with rich case morphology, such as Latin and Finnish, subject noun phrases and object noun phrases will be identified with different case markers. Consequently, these functions do not need to occur in fixed positions in the clause. Moreover, GFs such as SUBJ and OBJ cannot be defined in terms of semantic roles since these do not bear the same role in the various constructions in which they occur. For example, in English, the subject can assume various semantic roles such as agent, instrumental, recipient, experiencer, theme, etc., or it may not have a semantic role at all, as in the case of a sentence like *It is raining*. LFG assumes the following universal inventory of GFs, in the sense that they are claimed to exist cross-linguistically (Bresnan 2001:96, Dalrymple 2001:9).

(108) SUBJ, OBJ, OBJ_θ, COMP, XCOMP, OBL_θ, ADJ and XADJ

It is beyond the scope of this chapter to discuss each of these grammatical functions in detail. Here we intend only to give a general overview of the GFs that are

significant to our study, i.e. OBJ, OBJ_θ, OBL and ADJ. Moreover, these grammatical functions are discussed in detail in various sections of this thesis. For a discussion of applied objects, obliques and adjuncts the reader is referred to chapters 4, 6, 7 and 8.

The GFs listed in (108) can be cross-classified in various ways. They can be distinguished as *governable* and *non-governable (modifier)* functions, as shown in (109).

(109)

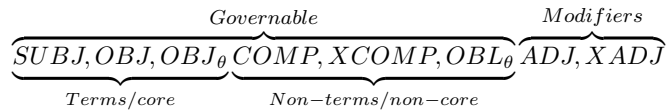

The governable functions are ‘relators’ or ‘links’ that connect the c-structure to the a-structure since these are argument functions (a-fns) for which a predicate is subcategorized (Bresnan 2001:9). Modifiers are non-subcategorizable functions as they are not semantically required arguments. In LFG, these are identified as ADJ (adjunct) functions. The governable functions are further classified as *terms* and *non-terms*. Terms are also known as core GFs, and they are distinguished from non-terms by certain properties. For example, terms are expressed with nominal phrases and can be marked with nominal case markers such as the nominative and the accusative. Moreover, terms trigger grammatical agreement. In contrast, non-terms lack such grammatical properties.

GFs can also be classified as *semantically unrestricted* or *semantically restricted*. SUBJ and OBJ reflect the former property, while OBJ_θ and OBL_θ reflect the latter property. The *θ* subscript on these grammatical functions indicates the affinity that these objects have to specific semantic roles. The objects that reflect the restricted property are usually coded with a case marker or a prepositional particle that identifies their specific meaning. For example, some languages assign a dative case to the arguments of certain verbs that are semantically subcategorized for them. Such dative arguments are assumed to be associated with the restricted object function OBJ_{ben}. Moreover, many languages have distinct prepositions that mark semantic relations such as locative, ablative, allative and instrumental relations. Such prepositional arguments are associated with the family of oblique functions OBL_θ. Semantically unrestricted functions are not tied to a particular semantic role, as they can assume several different semantic roles. As the Tigrinya examples in (110) show, the SUBJ can be associated with an agent (110a), a theme (110b), an experiencer (110c), an instrument (110d), or a recipient (110e), among others.

- (110) a. ገግግ/ግ^wäyiy-a ‘she ran’ > agent
- b. ገገገ/däqis-a ‘she slept’ > theme
- c. ለለ/ገhazin-a ‘she became sad’ > experiencer
- d. ገገ ለገገ/ገkarra ገharid-u-wa ‘A knife cut her.’ > instrumental
- e. ገገገገ/tä-qäbil-a ‘she became happy’ > recipient

Like SUBJ, OBJ is also assumed to be unrestricted with respect to semantic roles. For example, in English the OBJ function, also known as the primary object, is associated with a theme/patient semantic role in monotransitive clauses, and with a recipient/beneficiary semantic role in dative-shifted clauses. In Chichewa, OBJ relates to the theme/patient role in monotransitive clauses, and to applied roles such as the beneficiary, locative and instrumental in double object applicative clauses (Bresnan and Moshi 1993). Further discussion on the unrestricted vs. restricted property of objects can be found in chapters 7.5.1 and 8.2.

The object functions OBJ and OBJ_θ assumed in LFG do not consistently map with the category of objects assumed in traditional grammar. Traditional grammar, as well as Relational Grammar (RG) (discussed in chapter 7.3), employ the direct object (DO) and indirect object (IO) designations to refer to the two objects of double object clauses. The DO is associated with the theme or patient role or the sole object argument of a monotransitive verb, while the indirect object refers to arguments that bear semantic roles such as a recipient or a beneficiary. Thus, the DO and IO classification is based on the object’s alignment to semantic roles rather than to its grammatical function (Kroeger 2004:15); however, these object categories cannot describe objects in all languages. For example, the DO and IO distinction corresponds with OBJ and OBJ_θ, respectively, in languages such as German (Kroeger 2004:21) and Korean (Müller-Gotama 1994:42), where the semantic distinction between dative and accusative objects is well preserved. However, in languages such as English and Chichewa, the IO description does not correspond to OBJ_θ, nor the OBJ to DO. In these languages, the recipient/beneficiary arguments in double object clauses assume the OBJ function, whereas the theme semantic role assumes the OBJ_θ function (Bresnan and Moshi 1990:159).

Grammatical functions such as COMP, XCOMP and XADJ are identified as clausal functions. These functions cannot be classified as semantically unrestricted or restricted functions since they do not code arguments with participatory roles in the verbal event. Rather, they describe or name events or situations. COMP and XCOMP have a predicate complement function since they are governable functions, but XADJ has a predicate adjunct function since it is a non-governable function. These clausal functions can be classified as either closed or open functions. COMP is a closed function because it has an internal subject, whereas XCOMP and XADJ are open functions since they do not have an internal subject. As these grammatical functions are not directly relevant to the theme of this thesis, we will not elaborate upon them further. For detailed discussion the reader may refer to Dalrymple (2001:24) and Kroeger (2004:266-268).

In the following section, we will discuss another level of grammatical representation in LFG known as discourse structure representation. The type of functions that are considered in discourse representations are called discourse functions. Discourse functions are relevant to this thesis since applicatives are assumed to code a change in discourse construal of the applicatively expressed arguments. Applied objects are perceived to be the discourse prominent arguments in the applicative clause (Nazareth 2007). The discourse function of applied objects will be discussed in chapters 6 and 9.

3.4 Discourse function representation

Discourse functions (DFs) are integrated in two ways in LFG. Commonly, discourse functions such as TOPIC and FOCUS are enclosed in the f-structure (Bresnan and Mchombo 1987, Butt and King 1996, Bresnan 2001, Dalrymple 2001, Falk 2001). Alternatively, some studies have opted for a separate projection called i-structure (information structure) or simply d-structure (discourse structure), for example, King (1997), Choi (1999), Butt and King (2000), among others. In some cases, due to the property sharing characteristics of the functional annotation system, discourse functions may be incorrectly scoped over larger constituents. Such issues necessitate a separate i-structure projection in LFG.

In early LFG the discourse functions TOPIC and FOCUS were regarded as grammaticalized or syntacticized functions. The role these discourse functions play is specifically indicated in syntactic phenomena such as relative clauses, interrogative clauses, extraction constructions and left dislocation. Bresnan and

In the clause (115b) there is no displaced constituent with which the FOCUS element needs to identify functionally or anaphorically, as the Extended Coherence Condition (ECC) would require grammaticalized discourse functions to do. Instead, it is analyzed as FOCUS on the basis of its role as a pragmatic assertion in the proposition conveyed in the discourse. However, DFs can only be regarded as grammaticalized functions when they are associated with some kind of grammatical marking or marked by prosodic means such as stress or accent.

Wh-questions involve a type of focus domain known as argument focus or narrow focus, as in (115a). In argument-focus constructions, the focus element corresponds to a specific argument or participant. When information structure roles scope over specific arguments, then it is not problematic to represent the discourse structure in the f-structure, as pointed out by King (1997). However, she also observes that information structure roles assigned to f-structure heads cannot be properly represented within the f-structure. A discourse function assigned to an f-structure head scopes over all the elements projected by it, thus it becomes impossible, for example, to express that it is only the lexical head that is the focus domain. Let us consider the example in (116).¹

- (116) a. Did she eat the banana?
 b. No, she [THREW] it.
 FOCUS

If we assume that sentence (116b) is given as a reply to the question in (116a), the verb *threw* is picked out as the prominent new information.

King (1997) proposes independent f-structure and i-structure projections because phenomena such as contrastive focus on verbs (116b) and focus of a VP (118) results in incorrect scoping of focus to maximal projections, including the argument and the predicate.

- (117) Ona [pročítala knihu]
 FOCUS
 She read book

King (1997) suggests that contrastive focus such as the predicate focus in the Russian sentence (117) should be analyzed in separate f-structure (118b) and i-structure (118c) projections. The FOCUS discourse function is assigned only to the relevant node by annotating it with $(\downarrow \text{ PRED FN}) \in (\uparrow_i \text{ FOCUS})$. The PRED contains the extension FN which will enable us to refer only to the semantic form

¹The word is written in capital letters to mark its intonation as a stressed or accented element.

without instantiating the subcategorized arguments (SUBJ and OBJ) of the predicate (Kaplan and Maxwell 1996:89).

(118) a. I-structure annotation

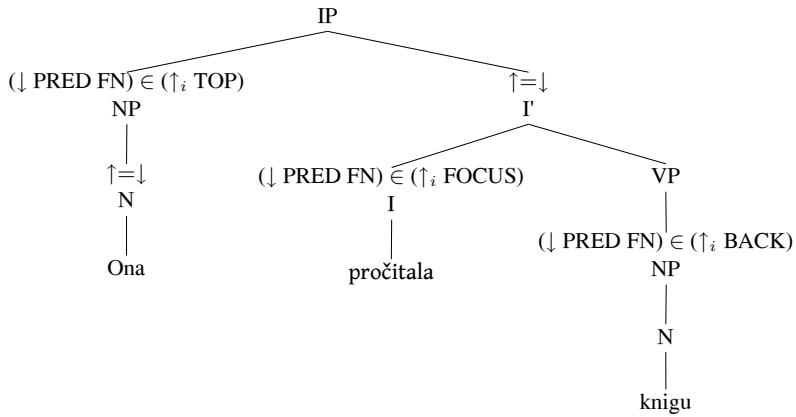

b. F-structure

PRED	‘read ⟨SUBJ, OBJ⟩’
PRED FN	‘read’
SUBJ	[PRED ‘she’]
OBJ	[PRED ‘book’]

c. I-structure

TOPIC	{‘she’}
FOCUS	{‘read’}
BACK	{‘book’}

The f-structure in (118b) contains a separate f-structure for the core semantic form ‘read’ which is the focus domain. The PRED attribute has the extension ‘FN’ to refer to the component of the semantic form as the focus domain. In the i-structure representation (118c), the core meaning of the verb appears as the value of the FOCUS feature.

It is beyond the scope of this thesis to review all the studies that have dealt with discourse structure or i-structure representation in LFG. Here we only aim to give a few examples of the state of the art. The interested reader should consult Butt and King (2000), Choi (1999), King and Zaenen (2004), O’Connor (2006), Asudeh (2004) and Mycock (2006) for further discussion of i-structure and d-structure rep-

resentation in LFG.

The kind of information structure roles relevant to our study can be integrated in the f-structure easily. Therefore, in this study we will not consider a separate d-structure projection.

3.5 Summary

This chapter discussed the main tenets of LFG. We presented various levels of representation, such as c-structure, f-structure, a-structure and d-structure. The a-structure and d-structure are commonly represented within the f-structure, even though it is also possible to model them in separate projections. The functional annotation system we illustrated in relation to f-structure and d-structure gives LFG strong grammatical modularity where grammatical information about phrase organization, grammatical functions, predicate-arguments and discourse functions can be modeled as parallel and independent structures which are held together by constraints declared through the annotation system. Most of the points discussed in this chapter will be expanded in subsequent chapters in this thesis.

Part II

Applicative constructions

CHAPTER 4

The applicative phenomenon

4.1 Introduction

The term ‘verbos applicativos’ was used for the first time in 1645 in the grammar of Nahuatl, an Uto-Aztec language (Carochi s.j. 2001:247). In this work, the term is used to denote verbal suffixes that correspond to object arguments which bear peripheral semantic roles. Later the term was used by Bantu scholars for similar phenomena (Stapleton 1903). Since research on Bantu languages pioneered most studies on applicative constructions within generative linguistic theories such as GB (Baker 1988a,b) and LFG (Bresnan and Moshi 1990, Alsina and Mchombo 1993, Harford 1993), this phenomenon has been recognized as an important property of this language family for a long time. However, recent studies reveal that there are many other languages which employ this phenomenon, some of them even more productively than Bantu languages (Peterson 2007, Polinsky 2005). For instance, applicative constructions are attested in *Tukang Basi* and *Bajau*, both Austronesian languages (Donohue 1996, 2001), in more than 20 Salish languages spoken in British Columbia and the northwestern United States (Kiyosawa 2006), in *Hakha Lai*, a Sino-Tibetan language (Peterson 2007, 1999), and in *Amharic*, an Abyssinian (Ethiopian) Semitic language (Amberber 2000, 1996).

In *Tigrinya* the applicative phenomenon has never been studied in its own right, and there are very few grammar books of the language that even identify the phenomenon. The first book that refers to these constructions is *Grammatica Analitica*

della Lingua Tigray (Leonessa 1928:104-108) which is perhaps the only book to describe the applicative suffixes in detail. Leonessa identifies two types of pronominal object suffixes which he designates as ‘suffissi di oggetto o di caso diretto’ (suffixes of object or of direct case) and ‘suffissi di oggetto o caso indiretto obliquo’ (suffixes of object or indirect oblique case). His categorization correlates with the object suffix forms that are glossed as OM₁ and OM₂ in this study. In addition, this work associates these verbal suffixes with recipient, beneficiary and locative semantic roles. Other writers who mention applicative verbal suffixes include Abba Mathewos (1951) and Masson (1994).

Since definitions of applicative constructions reflect the theoretical assumptions of the linguistic framework they are couched in, the term *applicative* requires some explanation. Here, we would like to present a brief review of some formulations by researchers working within various theoretical frameworks. Comrie (1985:316), working within a syntactic typology and descriptive framework, views the applicative as a verb derivation process which employs explicit and formal marking of verbs to indicate valency change leading to increase and/or rearrangement of objects relative to the valency of the basic non-derived verb form. Some languages employ this formal mechanism more freely than others by allowing wider classes of verbs to host the applicative affix, whereas others may restrict it to certain verb classes. Increase in valency implies adding a new object argument bearing a semantic role that has no correlation to the basic meaning of the verb, while rearrangement involves transforming a semantically bound argument of a verb (i.e. an oblique object) into an argument more closely bound by the verb (i.e. a direct object). According to Comrie (1985), in some cases, there is no clear distinction between these two processes, since the applicative process may effect both increase and rearrangement. For example, a semantically peripheral argument (e.g. an adjunct with an instrumental semantic role that can be expressed by a prepositional phrase) can be advanced to a more central object argument leading to both an increase and a rearrangement of valency. He identifies the applicative verbal affixes as *prepositional* in nature. In fact, he uses the term ‘applicative verb’ interchangeably with ‘prepositional verb’. According to Comrie, these verbs commonly introduce objects that bear a benefactive/maleficiary, recipient, or motion towards, semantic role. He provides examples of applicative constructions from a variety of languages such as German (Indo-European, Germanic), Russian (Indo-European, Slavic), Chukchee (Chukotko-Kamchatkan, Northern Chukotko-Kamchatkan spoken in Russia), Classical Nahuatl (Uto-Aztecan, Aztecan), Wolof (Niger-Congo,

Northern Atlantic) and Swahili and Luganda (both Niger-Congo, Bantu).

Another more theoretically focused characterization of applicative constructions is given by Baker (1988a) in his incorporation analysis within the Government and Binding program. According to Baker (1988a:9), the term applicative refers to a set of closely related GF (grammatical function) permutations that allow obliques, indirect objects and null preposition objects¹ to become objects. Baker argues that the applicative construction can be crosslinguistically analyzed as the incorporation of adpositions, which originally license oblique or adjunct phrases, into the verb stem. The incorporated adpositions may be associated with dative/goal, benefactive/malefactive, instrumental, or locative semantic roles. According to The Uniformity of Theta Assignment Hypothesis (UTAH), the applicative affix that the verb bears is a prepositional marker that case (theta) marks the applied object. The process is identified as a type of head movement (Baker 1988a:229) since the assumption is a prepositional marker which heads a PP moves to adjoin to the head of another category, i.e. the verb. The theoretical implication of this type of analysis will be discussed in Chapter 7.

In LFG, the formation of the applicative verb is viewed as a lexical process. Bresnan and Moshi (1990:48) state that “the applicative construction arises from a derived verb form that introduces a new object argument to the base verb”. This characterization emphasizes the role of the applied predicate which by virtue of the applicative suffix is subcategorized for an applied object. LFG’s treatment of applied objects will be discussed in Chapter 8.

In some definitions of applicative constructions, notions such as ‘peripheral’, ‘adjunct’ and ‘non-subcategorizable’ as opposed to ‘core’ and ‘subcategorizable’ are somehow vaguely used to describe the type of arguments that are implicated in applicative coding. One such definition is given by Peterson (2007:1) as in, “Applicative constructions are a means some languages have for structuring clauses which allow the coding of a thematically peripheral argument or adjunct as a core-object argument”. Since applicative affixes can be associated with arguments that range from subcategorizable to non-subcategorizable, designations such as ‘thematically peripheral’ or ‘non-subcategorizable’ do not adequately describe the aspect of gradience that characterizes semantic arguments. For example, when the applied

¹Since Baker assumes that every applied object is assigned a semantic role by a preposition, applied objects of intransitive verbs are assumed to have the same deep representation as those which have oblique counterparts even though at a surface level they do not have overt prepositions, and thus they are null.

morpheme assigns core argument status to the recipient of verbs like *give* or the maleficiary/beneficiary of verbs like *die*, the applied arguments involved are not thematically peripheral to the same degree.

The definitions we discussed above mainly emphasize the morphosyntactic aspect of applicative constructions. There are also other studies which highlight the discourse aspect of these constructions (Givón 1983, Rude 1986, Donohue 2001, Peterson 1999, Dalrymple and Nikolaeva 2007). Rude (1986) and Donohue (2001), for instance, argue that alternative expressions of a given semantic role as an oblique or applicative argument is motivated by the discourse salience of the referents. They assume that applicatively expressed arguments have higher discourse salience than their oblique counterparts. Dalrymple and Nikolaeva (2007) follow a similar line of reasoning suggesting an information structure role approach to account for differential coding of objects. They argue that languages can signal information structure roles, i.e. topic and focus, of object arguments through grammatical encoding such as case and pronominal marking. They point out that objects that are preferentially treated for case and pronominal marking indicate higher discourse salience than those which are dispreferred. It is commonly observed that the need to employ an applicative expression is motivated by a variety of semantic and discourse factors. Much research seems to indicate that in most cases the applied object has discourse prominence and the overall result of the action affecting the applied object itself is often highly topical or central in the discourse event (Gerds and Kiyosawa 2006). The discourse function of applied objects will be elaborated in Chapter 9.

Therefore, we would like to combine these two aspects that characterize applicative constructions in this work. We define the applicative construction as a grammatical expression that morphosyntactically codes an altered construal of an event. The applicative clause involves a verb with an applicative morpheme by virtue of which an object argument which may bear a semantic role such as recipient, goal, beneficiary, maleficiary, instrumental, locative, source, comitative, etc. is subcategorized for, and the resulting applied argument has a greater discourse salience.

In the remainder of this chapter we will describe the applicative phenomenon in detail with data from Tigrinya alongside some parameters that are believed to vary cross-linguistically. In Section 4.2 we will present the morphosyntactic and discourse perspectives through which the applicative operation can be explained. In Section 4.3 we will explore the morphological coding of applied objects. Following that, in Section 4.4 we will outline the semantic roles that can be coded

applicatively.

4.2 The applicative operation

From a morphosyntactic point of view, the applicative construction is a morphosyntactic process that operates on the argument structure of a verb. In this construction, the verb is marked with an applicative morpheme by virtue of which a new object argument is introduced to the basic argument list of a verb (Peterson 2007, Bresnan and Moshi 1990). The object argument that is introduced in this manner may bear one of a number of semantic roles: recipient, beneficiary, maleficiary, instrumental, locative, goal or source. Example (119) illustrates this process.

- (119) a. **ዮናስ ነቲ መጽሓፍ ገዘኡዎ ።**
 yonas n-ät-i mäṣḥaf gäzi?-u-wo
 Yonas.M Obj-Det-3MSg book.Sg PerfS.buy-SM.3MSg-OM₁.3MSg
 ‘Yonas bought the book.’
- b. **ዮናስ ንሳባ መጽሓፍ ገዘኡላ ።**
 yonas ni-saba mäṣḥaf gäzi?-u-la
 Yonas.M Obj-Saba.F book.Sg PerfS.buy-SM.3MSg-OM₂.3FSg
 ‘Yonas bought Saba a book.’
- c. **ንዮናስ እምኒ ወዲቕዎ ።**
 ni-yonas ?imni wädiq̄-u-wo
 Obj-Yonas stone.Sg Perf.fall-SM.3MSg-OM₁.3MSg
 ‘A stone fell on Yonas.’

In (119a) the verb *gäzi?ä* ‘he bought’ is subcategorized for agent and theme arguments which are expressed as subject and object, respectively. The subject NP *yonas* ‘Yonas’ and the definite object NP *n-ät-i mäṣḥaf* ‘the book’ are marked with the pronominal suffixes *-u* and *-wo* on the verb. However, in (119b) the verb carries a different verbal suffix, *-la*, which corresponds to the object NP *ni-saba* ‘(for) Saba’ that fills the beneficiary argument. In (119c) the intransitive verb *wädäq̄ä* ‘it fell’, which initially is subcategorized for a theme argument, through the verbal suffix *-wo* codes the applied object *ni-yonas* ‘(on) Yonas’ that has a maleficiary semantic role. The applied object is preposed since it corresponds to a semantically prominent argument. As these examples show, in Tigrinya applied objects are coded via verbal suffixes.

Discourse based approaches, on the other hand, emphasize the factors that necessitate the applicative expression. Research indicates that the use of applicative

constructions correlates with a number of semantic and discourse oriented factors (Rude 1986, Givón 1976, 1978, Donohue 2001). Discourse-prominent referents routinely co-occur with certain semantic classes of nouns, i.e. with animate, pronominal, definite, specific, identifiable, etc. referents rather than with inanimate, non-pronominal, indefinite, non-specific, non-identifiable ones. In some languages this differentiation is overtly indicated through obligatory case or/and pronominal marking of objects that rank high in these semantic features. In Tigrinya only definite/specific objects trigger case and pronominal marking, as in (120).

- (120) a. **ዮናስ ንድኻታት ገንዘብ ሂቡ ።**
 yonas n-diḳa-tat gänzäb hib-u
 Yonas.M to-poor-Pl money PerfS.give-SM.3MSg
 ‘Yonas gave money to (the) poor.’
- b. **ዮናስ ነቲ ገንዘብ ንድኻታት**
 yonas n-ät-i gänzäb n-diḳa-tat
 Yonas.M Obj-Det-3MSg money to-poor-Pl
ሂቡዎ ።
 hib-u-wo
 PerfS.give-SM.3MSg-OM₁.3MSg
 ‘Yonas gave the money to (the) poor.’
- c. **ዮናስ ነቶም ድኻታት ገንዘብ ሂቡዎም ።**
 yonas n-ät-om diḳa-tat gänzäb hib-u-wom
 Yonas.M Obj-Det-3MPI poor-Pl money PerfS.give-SM.3MSg-OM₁.3MPI
 ‘Yonas gave money to the poor people.’
- d. **ዮናስ ነቲ ገንዘብ ነቶም ድኻታት**
 yonas n-ät-i gänzäb n-ät-om diḳa-tat
 Yonas.M Obj-Det-3MSg money Obj-Det-3MPI poor-Pl
ሂቡዎም ።
 hib-u-wom
 PerfS.give-SM.3MSg-OM₁.3MPI
 ‘Yonas gave the money to the poor people.’

The examples in (120) involve a ditransitive verb which is subcategorized for two object arguments bearing theme and recipient semantic roles. In (120a) the verb does not bear any object suffix since both objects are indefinite. The marker *nä-* functions both as a nominal case marker when it codes definite theme objects, as in *n-ät-i gänzäb* ‘the money’ (120b), and as a prepositional marker which is semantically linked to recipient and beneficiary arguments regardless of whether they are definite, as in *n-ät-om diḳa-tat* ‘to the poor people’, or not, as in *n-diḳa-tat* ‘to (the) poor’. In (120b) the verb bears an object suffix that corresponds to the definite theme object *n-ät-i gänzäb* ‘the money’, whereas in (120c) the object suffix corresponds to the definite recipient object *n-ät-om diḳa-tat* ‘the poor people’. The

theme and the recipient objects are coded with the same object suffix. The verb can accommodate only one object marker at a time. Thus, in situations where both objects are definite, the object that is perceived as central to the event/discourse is prioritized for pronominal marking. Since information questions, i.e. wh-questions, are a good basis for analyzing discourse structures (Lambrecht 1998:283), we employ this technique in order to illustrate the discourse motivation of applicatives (121).

- (121) a. የኖስ ነቶም ድኻታት እንታይ ሂቡዎም?
 yonas n-ät-om dika-tat ?intay hib-u-wom
 Yonas.M Obj-Det-3MPI poor-Pl what PerfS.give-SM.3MSg-OM₁3MPI
 ‘What did Yonas give to the poor?’
- b. ገንዘብ ሂቡዎም ።
 gänzäb hib-u-wom
 money.Sg PerfS.give-SM.3MSg-OM₁.3MPI
 ‘He gave them money.’

The speaker in (121a) assumes that the addressee is familiar with the subject referent ‘Yonas’ and the recipient object referent ‘the poor’ both introduced as definite and identifiable, i.e. as topics. According to Lambrecht (1998) subject referents tend to constitute primary topics, whereas object referents that are worthy of being cast as topics tend to constitute secondary topics. The verb in (121a) carries a verbal suffix for the definite recipient object. The wh-expression ?intay ‘what’ evokes the filler of the missing argument, thus since the referent is unfamiliar to the speaker, it constitutes the focus domain of the discourse. The reply to this question (121b) carries over the previously established pragmatic context. The fact that both the subject and the recipient object referents are not overtly realized as full noun phrases indicates that these are discourse-old referents, and thus are anaphorically expressed through verbal affixes. In this discourse context, the recipient object is cast as a secondary topic, while the theme object represents new information expressed as a full NP and therefore cannot be pronominally indexed on the verb. On the other hand, if we change the discourse context, as in (122) we notice a different grammatical encoding of the discourse referents.

- (122) a. የኖስ ነቲ ገንዘብ ንመን
 yonas n-ät-i gänzäb n-män
 Yonas.M Obj-Det-3MSg money.Sg to-who
 ሂቡዎ?
 hib-u-wo
 PerfS.give-SM.3MSg-OM₁.3MSg
 ‘To whom did Yonas give the money?’

- b. ንድኻታት ሂቡዎ ።
 n-dika-tat hib-u-wo
 to-poor-Pl PerfS.give-SM.3MSg-OM₁.3MSg
 ‘Yonas gave the money to the poor.’

In (122a) the subject and the theme object are topical since both have definite and identifiable referents. The controller of the verbal suffix corresponds to the topical theme object *n-ät-i gänzäb* ‘the money’. The wh-expression *n-män* ‘to whom’ evokes the missing argument, and thus constitutes the focus domain of the discourse which in (122b) is supplied with the expression of the recipient. Therefore, in Tigrinya, object verbal suffixes can only be associated with topical arguments, whereas object arguments that do not control object verbal suffixes constitute the foci domain of the discourse.

Discourse oriented approaches point out that applicative and the oblique expressions have different pragmatic functions. Donohue (2001:218) argues that the reason for choosing an applicative expression of a semantic role when a language has an option for coding that same semantic argument with an oblique phrase is motivated by discourse. The applicative codes higher discourse salience than the oblique expression of an argument. As we saw in examples (121) and (122) the recipient argument that controls a verbal suffix (121b) is more prominent in discourse than the one which does not (122b). We will further illustrate this point by giving two discourse situations in (123).

- (123) a. Discourse context: Yonas is told by his mother to place the book that he was reading on the bookshelf, but he instead puts it on a table. His brother reports this as follows.

አደ! ዮናስ ነታ መጽሐፍ ኣብ ጣውላ
 ?adä Yonas n-ät-a mäṣḥaf ?ab ʔawla
 mother Yonas Obj-Det-3FSg book on table
 ኣንቢሩዎ ።
 ?anbir-u-wa
 PerfS.place-SM.3FSg-OM₁.3FSg

‘Mother! Yonas placed the book on a table.’

- b. Discourse context: Yonas’ mother has cleared the table to set it for dinner, but Yonas had not noticed this, and thus he puts a book on it. His brother reports this to their mother.

አደ! ዮናስ ነቲ ጣውላ መጽሐፍ ኣንቢሩሉ ።
 ?adä Yonas n-ät-i ʔawla mäṣḥaf ?anbir-u-lu
 Mother Yonas Obj-Det-3MSg table book PerfS.place-SM.3MSg-OM₂.3MSg

‘Mother! Yonas placed a book on the table.’

In example (123a) the object pronominal suffix *-wa* corresponds to the argument that bears the theme semantic role, *māṣīḥaf* ‘book’, and the argument that bears the locative role, *ṭawla* ‘table’, is realized as an oblique phrase marked by the locative preposition *ʔab* ‘on’. In this discourse, the book has pragmatic salience since it is an identifiable and definite object; whereas the locative argument ‘table’ is less important in the discourse. It is one of the possible locations in the house where Yonas could have placed the book, in contrast to the bookshelf where the book was supposed to be placed. Its mention increases the addressee’s knowledge about where the book is placed. However, since it is not central to the event describe in the discourse, it is not coded as an applicative object. On the other hand, in the second discourse (123b) the locative argument has greater pragmatic salience which makes it worthy to be coded as an applied object. The verbal suffix *-lu* agrees with this locative argument which is also expressed in the nominal phrase with the objective case maker *ni-* instead of the oblique locative preposition *ʔab* ‘on’. The indefinite theme object has focus status in this discourse. An applied object that is highly topical in the discourse event may be cast as a core argument through the applicative morpheme. Therefore, an applicative construction can be viewed as a topicalization construction similar to passivization and relativization where only core arguments have more access to. We will discuss this topic further in Chapter (9).

4.3 Applicative coding

By definition, applicative constructions are signaled by verbal affixes in all languages that employ the phenomenon. In fact, this is the main property that distinguishes an applicative operation from other strategies that bring about double object construction; for example, the dative-shifted construction. Languages differ in the number and the grammatical category of the applicative markers. Some languages use a default applicative morpheme to code a variety of semantic roles. For example, most Bantu languages use a single applicative marker for various semantic roles. The realization of the marker may vary slightly within this class: *-i*, *-il* and *-ir*, which can vary depending on vowel harmony, are the most common markers of applicatives in Bantu languages. These are used in Swahili, Kichaga, Ndendeule, Bukusu, Chicheŵa and Chishona to code a set of semantic roles such as goal, beneficiary, maleficiary, instrumental, locative, motive, purpose, direction, etc. (Baker 1988a, Bresnan and Moshi 1990, Alsina and Mchombo 1993, Harford

1993, Ngonyani 1998, Peterson 2007). Kinyarwanda, in contrast, codes certain semantic roles with distinct applicative markers. The affixes *-ho* and *-mo* are used to code locative and instrumental applicatives, respectively, while *-er* marks a set of semantic roles such as a recipient, goal, beneficiary and maleficiary. Some languages use even more detailed applicative markers which correlate to adpositions that obliquely mark the corresponding semantic roles. In these languages the applicative markers and prepositions are homophonous forms. Two extreme instances of these are Hakha Lai, a Tibeto-Burman language and Abaza, a Northwest Caucasian Language. Hakha Lai, for example, uses *-piak* for benefactive/ malefactive, *-tse?m* for additional benefactive, *-pii* for comitative, *-hno?* for malefactive/allative, *-ka?n* for prioritive, *-taak* for relinquitive and *-naak* for instrumental (Peterson 2007).

Some languages allow multiple applied objects. In this case an applied verb hosts multiple applicative morphemes for each applied object. Some of the well known languages that allow multiple applied objects are Abaza, a Northwest Caucasian language (O'Herin 2001), Kinyarwanda, Kichaga and Kikuyu which are Bantu languages (Ngonyani and Githinji 2006), Koyraboro Senni, a Nilo-Saharan language (Heath 1999) and *Tukang Besi*, an Austronesian language (Donohue 2001, Peterson 2007). In the next section (4.3), we will describe the coding of applied objects in Tigrinya.

Tigrinya has two verbal suffix forms that are associated with applied objects. These are glossed OM₁ and OM₂ in this work. In the following group of examples, OM₁ codes a base object of a transitive verb (124a), a recipient object of a ditransitive verb (124b) and an applied object of an intransitive verb (124c).

- (124) a. የኖስ ነቲ መጽሐፍ ገበኡዎ ።
 yonas n-ät-i mäṣḥaf gäzi?-u-wo
 Yonas.M Obj-Det-3MSg book PerfS.buy-SM.3MSg-OM₁.3MSg
 'Yonas bought the book.'
- b. የኖስ ነቲ መጽሐፍ ንሳባ ካብኡዎ ።
 yonas n-ät-i mäṣḥaf ni-saba hib-u-wa
 Yonas.M Obj-Det-3MSg book Obj-Saba.F PerfS.give-SM.3MSg-OM₁.3FSg
 'Yonas gave Saba the book.'
- c. የኖስ ንሳባ ጎይዩዎ ።
 yonas ni-saba g^wäyy-u-wa
 yonas.M Obj-Saba.F PerfS.run-SM.3MSg-OM₁.3FSg
 'Yonas ran after/chased Saba.'

In example (124a) the verb bears the simple form object suffix *-wo* to code the definite base object *mäṣḥaf* 'book'. Indefinite objects are not marked with a

pronominal suffix however, as was mentioned earlier in connection with (119a). Example (124b) illustrates that the simple form also codes recipient/goal objects in double object constructions which result from ditransitive verbs. When OM₁ is attached to ditransitive verbs, it can ambiguously code either the base object or the goal object. In (124c) the intransitive verb *g^wäyäyā* ‘he ran’, in its basic form, has an agent role as its sole argument. However, when OM₁ is applied to it, the applied verb form codes an object argument with a maleficiary/affectee role which corresponds to the NP *nī-saba* ‘Saba’ in example (124c) .

Tigrinya uses the same pronominal morphemes as subject and object verbal suffixes. The subject and the object verbal suffixes are identified by their order in the verb stem. The subject suffix comes before the object suffix. For example, in *gäzi?-na-ka* ‘we bought you’ *-na* marks the subject and *-ka* marks the object, and they have first person plural and second person masculine singular agreement values, respectively. However, when the order is reversed as in *gäzi?-ka-na* ‘you bought us’, *-ka* and *-na* mark the subject and the object, respectively. In some phonological contexts the combination of the subject and the object agreement morphemes causes the OM₁ form to vary. In Tigrinya neither vowel sequences nor consonant clusters are allowed, and an obligatory consonant or semivowel onset is required for the formation of a valid syllabic structure. When an object pronominal marker that begins with a vowel is placed after a subject pronominal marker which ends with a vowel, an epenthetic marker emerges which serves as a syllabic boundary (Tesfay 2002:45). The following Table 4.1 lists the possible forms of OM₁ that can occur with the perfective-factual (traditionally called gerundive) verb forms.

gäzi?- ‘bought’ Subject	Object										
	3MSg	3FSg	3MPI	3FPI	2MSg	2FSg	2MPI	2FPI	1Sg	1PI	
3MSg	u	wo	wa	wom	wän	ka	ki	kum	kin	ni	na
3FSg	a	to	ta	tom	tän	tka	tki	tkum	tkin	tni	tna
3MPI	om	wo	wa	wom	wän	ka	ki	kum	kin	ni	na
3FPI	än	ʔo	ʔa	wom	ʔän	ka	ki	kum	kin	ni	na
2MSg	ka	yo	ya	yom	yän	-	-	-	-	ni	na
2FSg	ki/i	yo	ya	yom	yän	-	-	-	-	ni	na
2MPI	kum	wo	wa	wom	wän	-	-	-	-	ni	na
2FPI	kin	ʔo	ʔa	ʔom	ʔän	-	-	-	-	ʔ/a-ni	ʔ/a-na
1Sg	ä	yo	ya	yom	yän	ka	ki	kum	kin	-	-
1PI	na	yo	ya	yom	yän	ka	ki	kum	kin	-	-

Table 4.1: OM₁ of Perfective-factual verb

As is shown in 4.1, *-w* in *gäzi?-u-wa* and *-y* in *gäzi?-ka-ya* emerge as phonological boundaries to separate the vowel sequences *u-a* and *a-a*, respectively.

The second form, glossed here as OM₂, is formed out of the prepositional par-

ticle *-li* and the agreement morphemes. For example, *-la* in *gäzi?-u-la* is composed of the prepositional clitic *-li* and *-a*, the feminine third person singular agreement morpheme. In Ge'ez and Amharic, and in some dialects of Tigrinya, *-li* is used as a dative case marker or as an indirect object preposition. However, in standard Eritrean Tigrinya it does not exist as an independent preposition, it is only found as a formative of the OM₂ verbal suffix. When OM₂ is applied on transitive or ditransitive verbs, it can code a beneficiary, maleficiary, locative or instrumental semantic role, and when it is applied to intransitive verbs it codes a beneficiary semantic role, as is shown in (125).

- (125) a. አቲ መምህር ነቲ ሰደቓ መጽሐፍ
 ?it-i mämhir n-ät-i sedeqa mäṣḥaf
 Det-3MSg teacher Obj-Det-3MSg desk book
 ኣንቢሩሉ።
 ?anbir-u-lu
 PerfS.place-SM.3MSg-OM₂.3MSg
 ‘The teacher placed a book on the desk.’
- b. ዮናስ ንሳባ ጎይይላ።
 yonas ni-saba g^wäyy-u-la
 yonas-M Obj-Saba.F PerfSrun-SM.3MSg-OM₂.3FSg
 ‘Yonas ran for Saba.’

In example (125a) *-lu* corresponds to the object NP *näti sädäqa* ‘the desk’ which fills the locative argument, but in (125b) it agrees with the object NP *ni-saba* ‘Saba’ which bears a beneficiary semantic role. With OM₂ the phonological situation discussed above does not occur. Since the marker *-li* occurs between the subject and object suffixes, it serves as a boundary marker. Table 4.2 illustrates the repertoire of the different possible combinations of the subject and object suffixes for the perfective-factual verb forms.

gäzi?- ‘bought’ Subject	Object										
	3MSg	3FSg	3MPI	3FPI	2MSg	2FSg	2MPI	2FPI	1Sg	1PI	
3MSg	u	lu	la	lom	läñ	lka	lki	lkum	lkin	läy	lna
3FSg	a	ti-lu	ti-la	ti-lom	ti-län	ti-lka	ti-lki	ti-lkum	ti-lkin	ti-läy	ti-lna
3MPI	om	lu	la	lom	läñ	i-lka	i-lki	i-lkum	i-lkin	läy	lna
3FPI	än	a-lu	a-la	a-lom	a-län	a-lka	a-lki	a-lkum	a-lkin	a-läy	a-lna
2MSg	ka	lu	la	lom	läñ	-	-	-	-	läy	lna
2FSg	ki/i	lu	la	lom	läñ	-	-	-	-	läy	lna
2MPI	kum	lu	la	lom	läñ	-	-	-	-	läy	lna
2FPI	kin	a-lu	a-la	a-lom	a-län	-	-	-	-	a-läy	a-lna
1Sg	ä	lu	la	lom	läñ	lka	lki	lkum	lkin	-	-
1PI	na	lu	la	lom	läñ	lka	lki	lkum	lkin	-	-

Table 4.2: OM₂ of Perfective-factual verb

In the examples discussed above, the two types of object markers, OM₁ and OM₂, seem to semantically distinguish between event internal and event external objects. For example, the semantic difference between recipient and beneficiary objects is overtly reflected by the way in which they are morphologically coded. Recipients give the notion of an end point for the transfer of an object between two individuals. Thus, they are internal to the event denoted by the verb. Beneficiaries, on the other hand, denote a relation between an event and an individual external to the event. This distinction can also be extended to applied objects of intransitive verbs which usually use OM₁ and OM₂ to code the semantic roles affectee/goal contrasted with beneficiary/locative, respectively. Let us consider example (126).

(126) a. *Affectee object argument*

ዮናስ ነታ ኸርሲ ኮፍ ኢሉዋ ።
 yonas n-ät-a k^wursi kof ?il-u-wa
 yonas-M Obj-Det-3FSg chair.Sg sit PerfS.be-SM.3MSg-OM₁.3FSg
 ‘Yonas sat (on) the chair.’

b. *Locative object argument*

ዮናስ ነታ ኸርሲ ኮፍ ኢሉላ ።
 yonas n-ät-a k^wursi kof ?il-u-la
 yonas-M Obj-Det-3FSg chair.Sg sit PerfS.be-SM.3MSg-OM₂.3FSg
 ‘Yonas sat on the chair.’

In example (126a) the object is perceived as being affected by the event, that is to say, the chair sustains the weight of the sitter. In example (126b), on the other hand, the object argument has a locative role and is understood as a location where the sitter is situated without giving any information on its involvement in the event.

In some languages, the applicative verbal suffixes code both the semantic role of the argument and its agreement value. However, in other languages, the applicative marker codes only the semantic role of the argument without specifying its agreement values. These differences may have significant bearing on the grammar of applicatives.

In addition to verbal suffixes, definite base and applied objects are coded with a case marker. Definite base objects as in example (124a) bear an obligatory case marker *nɨ*, whereas indefinite base objects are unmarked. Applied object NPs are also marked with the same marker *nɨ*, as can be seen from examples (126a) and (126b). Thus, since Tigrinya does not have distinct case markers that distinguish between different object functions, the conventional name ‘objective case’ will be used to identify the *nɨ* marker, and it will be glossed as ‘Obj’ in this work.

4.4 Applied semantic roles

Languages differ as to the number and types of semantic roles they allow in their applicative constructions. Some of the semantic roles that are attested cross-linguistically in applicative constructions are: recipient, benefactive, malefactive, goal, locative, directional, allative, ablative, source, comitative, prioritive, relinquitive, reason, purpose, stimulus, experiencer, circumstantial, possessor, etc. The list may be longer or shorter depending on how one wants to distinguish all the particular semantic roles that a verb may assign, or it may contain general labels which subsume various semantic roles with shared semantic properties.

In principle, an applied object may bear any semantic role other than that of theme/patient and agent roles. The most cross-linguistically attested applied semantic roles tend to be those of beneficiary and recipient/goal, followed by locative and instrumental semantic roles (Kiyosawa 2006, Polinsky 2005). According to a survey conducted by Peterson (2007, 1999) using a sample of fifty languages, a significant number of languages employ a comitative role. Applied comitative constructions seem to be even more frequent than the dative/goal applied semantic role, as is shown in Table 4.3.

	ben	com	dat/goal	inst	loc	mal	all	circ	abl
freq.	41	27	22	22	18	13	13	9	8

Table 4.3: Frequency of occurrence of various semantic roles according to Peterson (2007:247)

However, some languages reflect anomalies with respect to certain semantic roles. As Kiyosawa (2006:327) points out, instrumental, comitative and source applicatives are not common in Salish languages. For example, out of the twenty-seven Salish languages she investigated, only one language, Bella Coola, contains instrumental applicatives, although instrumental applicatives appear to be very common elsewhere.

Even though frequency surveys such as the one given in Table 4.3 can be informative in terms of which semantic roles are cross-linguistically attested, they should not be used as accurate figures to derive a cross-linguistic ranking of applicative semantic roles. Owing to the fact that the data for such surveys come from secondary sources (which is the case for the surveys by Peterson (1999, 2007) and Polinsky (2005)), it is difficult to ensure comparability of the applicative semantic roles outlined for each language in these sources. In addition, there is no agreement

among linguists on the number and type of semantic roles for a given language, let alone for the world's languages. Kiyosawa (2006) points out that the frequency of the circumstantial semantic role might be skewed up in Peterson's survey because the circumstantial role may be employed as a cover term for reason and stimulus semantic roles as well. According to Kiyosawa (2006:328) what Donohue (1994:416) identifies as a circumstantial semantic role in *Tukang Besi* is properly understood as a reason semantic role, as is shown in (127).

- (127) No-mate-ako te buti
 3REALIS-die-Appl CORE fall
 'They died in a fall.'

There is also a tendency to include semantic roles such as recipient, ablative, allative or source under general labels such as beneficiary, maleficiary, goal or locative semantic roles. In fact, it is cross-linguistically observed that many languages employ polysemous applicative morphemes for a set of semantic roles that share certain properties. For example, in *Hakha Lai* a polysemous applicative marker -*ʔaʔ* is used to mark the following semantic roles: beneficiary, maleficiary, locative, allative and ablative (Peterson 2007:41). In addition, the beneficiary -*tseʔm*, comitative -*p̄ii*, prioritive -*kaʔn*, relinquitive -*taak* and instrumental -*naak* semantic roles are coded by distinct markers. Another language, *Nomatsiguenga*, an Arawakan language spoken in Peru, contains distinct markers, -*ne-* for beneficiary, -*mo-* for locative and -*te-* for allative applied objects (Peterson 2007:42). Languages that employ distinct applicative markers for individual semantic roles exhibit less semantic ambiguity. *Nomatsiguenga* exhibits less semantic ambiguity than *Hakha Lai*. When a language employs a polysemous applicative morpheme, a specific reading of a distinct semantic role is foregrounded through the use of specific contexts and events. For example, the allative reading may emerge more evidently with verbs such as *carry*, *bring*, *take*, *transport*, etc., and the goal reading may be more apparent with verbs that express a spatial or temporal path such as *reach*, *arrive*, *come*, *go*, *run*, *walk*, etc.

Another interesting issue is the overlap of semantic roles, i.e. an argument filling more than one role simultaneously. Some of the semantic overlap seems quite reasonable. For example, in *Tigrinya* the applied object of the verb *fall* as in (119c) can have both locative/goal and maleficiary/affectee readings. However, some overlap cases fail to conform to a traditional categorization of semantic roles. For example, an additional beneficiary (glossed as -ADD BEN in (128a)) in *Hakha Lai* (Peterson 2007:41) and a possessor beneficiary/maleficiary in *Okanagan* (Gerdts

and Kiyosawa 2005:53) can be expressed with a single applicative morpheme, as in (128).

- (128) a. *Hakha Lai*
 thiŋ ʔa-ka-laak-tseʔm
 wood 3Sg.S-1Sg.O-carry-ADD BEN
 ‘He carried wood for me (in addition to carrying wood for himself).’
- b. *Okanagan*
 Mary ʕác-ł-t-s iʔ ttwít iʔ kðwáp-s
 Mary tie-POS-TR-3ERG ART boy ART horse-3POSS
 ‘Mary tied the boy’s horse (for him).’

In (128a) the additional beneficiary applicative implies that both the applied object and the subject benefit from the event denoted by the verb, and the applied object in (128b), in addition to being a possessor, is also perceived as an implied beneficiary. In the following sections we aim to explore the semantic roles of applied objects in Tigrinya. Applicative constructions in Tigrinya allow for the coding of recipient, beneficiary, maleficiary, goal, source, locative, instrumental, path, experiencer and possessor semantic roles. An applied expression with a comitative semantic role, however, is not commonly attested, except for a few verbs, such as *tä-sämamʕä* ‘he agreed’, *tä-wäʕaʕalä* ‘he contracted’ and *tä-ħababärä* ‘he cooperated’, that morphologically mark an associative function on the verb. Otherwise, comitative semantic roles are incompatible with applicative expressions. For example, the comitative argument in clauses such as *He weeded his field with his friend* cannot be expressed applicatively in Tigrinya. The reading of a semantic role depends on the form of the applicative affix, the semantics of the base verb and the context of use. Semantic properties of the base and applied verbs will be discussed further in Chapter 5. In this section we will only focus on the types of semantic roles that can be expressed applicatively in Tigrinya.

4.4.1 Recipient

In Tigrinya there is a small number of verbs that can be characterized as prototypical ditransitives since the recipient object of these verbs is coded in the same way as the theme, and they exhibit syntactic properties that are characteristic of theme objects. We characterize the recipient arguments of these verbs as implicated or affected objects. Typically an affected or implicated applied object has a recipient or goal/locative semantic role reading (affected locatives are discussed in section 4.4.3). Implicated recipient objects are coded with the suffix OM_1 , which is also

employed for coding definite theme objects in monotransitive clauses. Verbs such as *habä* ‘he gave’, *ʕaddälä* ‘he distributed’, *ʕaräkäbä* ‘he handed’, *ʕaläqḥä* ‘he lent’, *käfälä* ‘he paid’, *mäcälä* ‘he shared/divided’, *ʕakaräyä* ‘he rented out’, *nägärä* ‘he told’, *mäharä* ‘he taught’, *ḥatätä* ‘he asked’ and *habbärä* ‘he directed/ he informed’ are typical examples of this class. The examples in (129) illustrate applicative constructions that involve some of these verbs.

(129) *implicated recipients*

- a. **እቲ ሓረስታይ ነተን ከብቲ ሳዕሪ**
 ʕit-i ḥarästay n-ät-än käbti saʕri
 Det-3MSg farmer.Sg Obj-Det-3FPI cattle grass
ሂቡዎን።
 hib-u-wän
 PerfS.give-SM.3MSg-OM₁.3FPI
 ‘The farmer gave the cattle grass.’
- b. **እቲ መምህር ነተን ተመሃሮ መጽሓፍቲ**
 ʕit-i mämhir n-ät-än tämähar-o mäṣḥaf-ti
 Det-3MSg teacher.Sg Obj-Det-3FPI student-Pl book-Pl
ዓዲሉዎን።
 ʕadil-u-wän
 PerfS.distribute-SM.3MSg-OM₁.3FPI
 ‘The teacher distributed books to the (female) students.’
- c. **እቲ ሰብኣይ ነቶም ስራሕተኛታት ደሞዞም**
 ʕit-i säbʕay n-ä-tom säraḥtäña-tat dämoz-om
 Det-3MSg man.Sg Obj-Det-3MPI worker-Pl salary-POSS.3MPI
ከፈሉዎም።
 käfil-u-wom
 PerfS.paySM.3FSg-OM₁.3MPI
 ‘The man paid the workers their salary.’

In these examples, the object NPs *käbti* ‘cattle’ in (129a), *tämähar-o* ‘students’ in (129b) and *säraḥtäña-tat* ‘workers’ in (129c), which have a recipient argument reading, are coded with OM₁. The recipient objects of such ditransitive verbs are perceived as fully involved participants in the event described by the verbs, and this information is inherently lexicalized within the core meaning of these verbs.

4.4.2 Beneficiary, maleficiary and goal

There is also a class of ditransitive verbs that code the recipient/beneficiary argument as an incidental/unaffected object. Incidental recipient objects are indexed on the verb through the suffix OM₂, and they lack some of the basic syntactic properties that a core object of a monotransitive clause exhibits. Verbs such as *wäfäyä*

‘he donated/offered’, *ʔabärkätä* ‘he presented’, *mälläsä* ‘he answered’, *šäyätä* ‘he sold’, *sädädä* ‘he sent’, *mäläsä* ‘he sent back/returned’, *wäsädä* ‘he took’ may either code the recipient object with OM₂ or the theme object with OM₁. The applied objects coded by this suffix (OM₂) may be ambiguously associated with a variety of semantic roles such as those of recipient, goal, beneficiary, maleficiary or a source semantic role, as the examples in (130) show.

(130) a. *recipient or beneficiary*

እቲ ሰብኣይ ነታ ንል ደርሆ
 ʔit-i säbʔay n-ät-a g^wal dārho
 Det-3MSg man Obj-Det-3FSg girl chicken
ወፊዩላ ።
 wäfy-u-la
 PerfS.donate-SM.3MSg-OM₂.3FSg

‘The man donated a chicken to/for the girl.’

b. *goal, beneficiary or maleficiary*

እቲ ሰብኣይ ነታ ሰበይቲ ደርሆ
 ʔit-i säbʔay n-ät-a säbäyti dārho
 Det-3MSg man Obj-Det-3FSg woman chicken
ሸይጡላ ።
 šäyt-u-la
 PerfS.sell-SM.3MSg-OM₂.3FSg

‘The man sold a chicken to/for/on the woman.’

c. *goal, source, beneficiary or maleficiary*

እቲ ሰብኣይ ነታ ንል መጽሓፍ
 ʔit-i säbʔay n-ät-a g^wal mäṣḥaf-a
 Det-3MSg man Obj-Det-3FSg girl book-Poss.3FSg
ወሲዱላ ።
 wäsidi-u-la
 PerfS.take-SM.3MSg-OM₂.3FSg

‘The man took the girl her book/took her book away from the girl/ took her book from the girl/ took her book for her.’

d. *goal or beneficiary*

እቲ ወዲ ነዲኡ ደብዳቤ
 ʔit-i wäddi n-ädiʔ-_u däbdäbe
 Det-3MSg boy Obj-mother.FSg-Poss.3MSg letter
ሰዲዱላ ።
 sädid-u-la
 PerfS.send-SM.3MSg-OM₂.3FSg

‘The boy sent a letter to/for his mother.’

In (130a), the *-la* suffix corresponds to the applied object NP *n-ät-a g^wal* ‘the girl’ which may ambiguously bear a recipient or a beneficiary semantic role. The

event depicted by the verb *wāfāyā* ‘he donated’ involves primarily an interaction which involves a donor and a donation, and an incidental recipient. In contrast to the implicated/affected recipient argument of the Tigrinya verb *wihu-wo* ‘he give him’, the involvement of the recipient argument in the *wāfiyu-lu* ‘he donated for him’ event is marginal. This semantic difference is morphologically indicated by the use of the two types of object suffix, OM_1 and OM_2 , in coding the recipient objects of the two types of ditransitive verbs. In addition, the verb *wāfāyā* ‘he donated’ allows a beneficiary applied object reading since its meaning depicts a positive intention, and as a result there is no maleficiary reading of the applied object. As this example shows, the semantic role restriction follows from lexical property of the verb. In (130b), the applied object may have a goal, beneficiary or maleficiary reading. In Tigrinya the participant that plays the role of a buyer in the selling transaction is best identified as a goal argument. The fact that this role can also be expressed alternatively through an oblique phrase which is coded by the allative preposition *nab* ‘to’, which is distinct from the dative preposition *ni-* ‘to’, suggests that the recipient role should be distinguished from the goal semantic role. The semantics of the verb *šāyātā* ‘he sold’ can also admit beneficiary and maleficiary semantic roles. Thus, the applied object in this example may bear a goal semantic role, the participant to whom the *dārho* ‘chicken’ is sold, a beneficiary semantic role, the participant who would benefit from the selling of the chicken, or a maleficiary to whose detriment the chicken is sold. In (130c) the lexical meaning of the verb *wāsādā* ‘he took’, in addition to the theme argument, may express a goal argument, as in ‘he took (something) to’, or a source argument, as in ‘take (something) from’. Moreover, a beneficiary reading can be retrieved from the former sense, and a maleficiary reading from the latter. The specific reading of ambiguously coded semantic roles may be deciphered from the pragmatic context. For example, the possessive pronominal maker on *māṣḥaf-a* ‘her book’ specifies that the book belongs to the referent of the applied object. Based on our pragmatic understanding, i.e. ‘taking away a belonging from someone is disadvantageous to the owner’, we perceive the applied object as a maleficiary argument. In (130d) the reading of a goal applied object is contained within the lexical meaning of the verb. In addition, the verb may also allow beneficiary and maleficiary semantic role readings. However, since receiving a letter from one’s own son is normally considered more of a benefit rather than a disadvantage, the beneficiary reading is more evident than the maleficiary reading. As examples (130a, 130b and 130d) show, we also need to appeal to world knowledge in order to get a specific reading of a semantic role. This suggests that

the markers OM₁ and OM₂ do not encode a specific reading of an applied semantic role, and thus the markers are underspecified for the various applied semantic roles (e.g. beneficiary, goal, maleficiary, source, etc.).

4.4.3 Locative

Tigrinya can also express a locative role applicatively. A locative applied role can arise either as an inherently lexicalized argument of a verb or as a semantically peripheral argument. For instance, the verbs *säqälä* ‘he hung’ and *däqäsä* ‘he slept’ can both host the verbal suffix OM₂ for an applicative locative role. In the case of the former verb the presence of a locative argument is inherently lexicalized in the meaning of the verb, whereas in the latter verb it is not. The applicative expression of the locative semantic role can also be conveyed by OM₁. A locative argument that is marked by OM₁ registers an affectedness meaning. In this sense, the location stands in some central relation to the event described by the verb, as is illustrated in (131).

- (131) a. እቲ ሓረስታይ ነታ እምኒ ኮፍ
 ?it-i ḥarästay n-ät-a ?imni kof
 Det-3MSg farmer Obj-Det-3FSg rock sit
 ኢሉዋ/ላ ።
 ?il-u-wa/la
 PerfS.say-SM.3MSg-OM₁/OM₂.3FSg
 ‘The farmer sat on the rock.’²
- b. (ኅ)እታ ገረብ ኣዕዋፍ ሰፊረኅኣ/ላ ።
 ni-?it-a gärab ?aʔwaf säfir-än-?a/la
 Obj-Det-3FSg tree bird.FPl PerfS.lodge-SM.3FPl-OM₁/OM₂.3FSg
 ‘The birds nested on the tree.’
- c. እቲ ሓረስታይ ነታ እምኒ
 ?it-i ḥarästay n-ät-a ?imni
 Det-3MSg farmer Obj-Det-3FSg rock

²The verb *kof ?ilu* ‘he sat down’ belongs to a type of verbs known as composite verbs (Hetzron 1972, Appleyard 2001). A composite verb consists of two elements: an uninflected ideophone that constitutes the lexical meaning of the composite verb and an inflected invariant verb derived from the verb *bähalä* ‘he said’, but it can also acquire different meanings such as ‘be’, ‘do’, or ‘make’, depending on the meaning of the ideophone that it co-occurs with. Ideophones depict sensory events by imitating the sound or the movement of objects, or by describing their posture or configuration. They are not nouns, verbs or adverbs. They are classified as an independent word class. The verbal function is performed via the verb *bähalä* ‘he said’ which has inflectional potential. In *kof ?ilu* ‘he sat down’, the ideophonic word *kof* depicts the sitting posture, whereas the verb *?ilu* which literally means ‘he said’ serves as a morphosyntactic unit that codes inflectional information such as tense-aspect and agreement, without contributing to the lexical meaning of the composite expression.

ደይቡዋ/ላ ።

däyb-u-wa/la

PerfS.climb-SM.3MSg-OM₁/OM₂.3FSg

‘The farmer climbed the rock./ The farmer climbed using (with) the rock.’

- d. **እቲ መምህር ነቲ ሰደቻ መጽሓፍ**
 ?it-i mämhir n-ät-i sedeqa maṣṣḥaf
 Det-3MSg teacher Obj-Det-3MSg desk book

አንቢሩሉ ።

?anbir-u-lu

PerfS.place-SM.3MSg-OM₂.3MSg

‘The teacher put/placed a book on the desk.’

- e. **እቲ ሓረስታይ ነታ በዓቲ ማሕረሻ**
 ?it-i ḥarästay n-ät-a bäʿati maḥräša
 Det-3MSg farmer Obj-Det-3FSg cave plough.Sg

ሓቢኡላ ።

ḥabi?-u-la

PerfS.hide-SM.3MSg-OM₂.3FSg

‘The farmer hid a plough in the cave.’

In example (131a) and (131b) *kof ?ilu* ‘he sat down’ and *säfarä* ‘it nested on’ may host either OM₁ or OM₂ for an affected and unaffected locative applied object, respectively. In contrast, the verb *däyabä* ‘he climbed’ in (131c) can only encode an affected locative/goal object through the suffix OM₁. The suffix OM₂ cannot express an unaffected locative applied object reading, but can express an instrumental reading. This seems to be due to the telic property of the verb *däyabä* ‘he climbed’. According to Hopper and Thompson (1980) telicity reflects a higher degree of transitivity and affectedness. In addition, the affected applied object reading yielded by this verb seem to be due to the unergative property of the verb. The referent of the applied object is directly affected by the action of an agent participant. Like the patient arguments of monotransitive verbs, referents of applied objects of unergative verbs are directly affected by the action of the agent argument. In this example, the climber walks on the rock from the bottom to the top, thus the rock sustains the momentum of walking. However, the locative applied arguments of the verbs *?anbärä* ‘he placed/put down’ (131d) and *ḥab?-ä* ‘he hid something’ (131e) are perceived as incidentally affected applied objects. When there is minimum contact or interaction between the agent and the locative argument, the locative argument is perceived as an unaffected applied object and is coded with the suffix OM₂. In these examples, the agent argument does not act directly upon the locative argument since it is the referent of theme argument that is acted upon; however, the referent of the locative argument is indirectly effected by the action. The *desk* in (131d) and *cave* (131e)

are portrayed as mere locations that carry or contain the referent of the theme object without coding any information concerning the interaction of the locative and theme referents.

Depending on the semantics of the base verb a locative argument can acquire different types of affectedness. In the examples (132) the locative arguments of the verbs *ṣāʿanā* ‘he loaded’, *zerʾä* ‘he sowed/planted’, *läkäyā* ‘he smeared/painted’ and *mälʾä* ‘he filled’ are perceived as affected objects on the basis of different kinds of semantic relations.

- (132) a. **እቲ ሓረስታይ ነታ ኣድጊ ሳዕሪ**
 ʾit-i ḥarästay n-ät-a ʾadgi saʿri
 Det-3MSg farmer Obj-Det-3FSg donkey hay
ጸዓኑዋ ።
 ṣāʿin-u-wa.
 PerfS.load-SM.3MSg-OM₁.3FSg
 ‘The farmer loaded the donkey with hay.’
- b. **እቲ ሓረስታይ ነታ ግራት ማሸላ**
 ʾit-i ḥarästay n-ät-a girat mašäla
 Det-3MSg farmer Obj-Det-3FSg field millet
ዘሪኡዋ ።
 zeriʾ-*u-wa*
 PerfS.sow-SM.3MSg-OM₁.3FSg
 ‘The farmer sowed the field with millet.’
- c. **እቲ ሓረስታይ ነቲ መንደቕ ኡብሪ**
 ʾit-i ḥarästay n-ät-i määndäq ḥibri
 Det-3MSg farmer Obj-Det-3MSg wall colour/paint
ለኸዩዎ ።
 läky-u-wo.
 PerfS.paint-SM.3MSg-OM₁.3MSg
 ‘The farmer painted the wall with paint.’
- d. **እቲ ሓረስታይ ነቲ ደንበ ሳዕሪ**
 ʾit-i ḥarästay n-ät-i dänbä saʿri
 Det-3MSg farmer Obj-Det-3MSg barn hay
መሊኡዎ ።
 mäliʾ-*u-wo*.
 PerfS.fill-SM.3MSg-OM₁.3MSg
 ‘The farmer filled the barn with hay.’
- e. **ነቲ ገዛ ሰብ ኣትዩዎ ።**
 n-ät-i gäza säb ʾaty-u-wo.
 Obj-Det-3MSg house person PerfS.enter-SM.3MSg-OM₁.3MSg
 ‘A person entered the house.’

In (132a) the suffix OM₁ *-wa* corresponds to the applied object NP *n-ät-a ʾadgi* ‘the donkey’. The verb *ṣāʿanā* ‘he loaded’ is not an alternating verb in Tigrinya, un-

like its English equivalent it can permit an oblique alternation only for the locative argument *ʔadgi* ‘the donkey’, but not for the theme argument. However, the theme argument *saʕri* ‘hay’ can only be expressed as a nominal object. The affectedness sense is not related to the animacy feature of the referent that fills the locative argument slot, since referents that can function either as a mode of transportation or a piece of furniture on which objects may be placed can serve as arguments and are coded with the suffix *OM₁*. With the verb *ʕāʕanā* ‘he loaded’, the applied locative object is understood as an affected object since it has to sustain the load. The locative argument of the verb *zārʔä* ‘he sowed/planted’ in (132b) is understood as an affected applied object because here the farmer does not just spread the seeds over the ground, but rather acts upon both the field and the seeds. Thus, this sense of affectedness involves assumptions such as the soil being turned over and the seeds being buried underneath it. Similarly, in (132c) the locative argument *mändäq* ‘wall’ is perceived as an implicated participant since the process of painting the wall involves applying paint by stroking the wall with an instrument, the wall being soaked with the paint, and the paint being absorbed by the wall. The affectedness nuance in (132d) and (132e) is evoked as part of the lexicalized meaning of the verbs *mälʔä* ‘he filled’ and *ʔatäwä* ‘he entered’ which conveys the information that the locative argument contains the theme object fully. The verb *mälʔä* ‘he filled’ also implies that the container comes to be pervaded or is occupied by the referent of the theme object. In contrast, verbs such as *zäräwä* ‘he scattered’, *näʕägä* ‘he sprayed/sprinkled’, *käʕäwä* ‘he spilled’ and *ʔaʕiräqä* ‘he poured’ lexicalize a minimum engagement or interaction between the agent and the locative participant and between the theme and the locative participants, and thus these verbs do not mark the locative argument as an affected applied object. Thus, their applicative locative objects are coded by *OM₂*.

4.4.4 Instrumental and path

The applied object is also underspecified for the instrumental reading. Like locative applied objects, instrumental applied objects can be coded by either the suffix *OM₁* or *OM₂* to express different affectedness readings. The *OM₂* suffix yields an instrumental reading when it is applied to verbs that in their lexical meaning entail the presence of an instrument or a tool. For example, the use of the suffix with verbs such *ḥaräsä* ‘he plowed’, *k^wäʕatä* ‘he dug’, *q^wäräsä* ‘he cut’, *laʕäyä* ‘he shaved’, *ḥarädä* ‘he knifed/murdered/slashed’, *harämä* ‘he hit’ and *wägʔä* ‘he pricked/punctured/injected’ will express the instrumental applied object reading, as

in (133).

- (133) a. አቦይ ነዛ ማሕረሻ እዚኣ ዓስርተ ዓመት
 ṽabo-y n-äz-a mahräša ṽizi-ṽ-a ṽassärtä ṽamät
 father-Poss.1Sg Obj-DetProx-3FSg plough ProxPro-3FSg ten year
ሐረሱላ ።
 ḥaris-u-la
 PerfS.plough-SM.3MSg-OM₂.3FSg
 ‘My father plowed with this very plough for ten years.’
- b. (ን)እታ ናይ ዓባይ መላጸ ጭሕሙ
 (ni)-ṽit-a nay ṽabbay-u mälašä ṽiḥm-u
 Obj-Det-3FSg of grandmother-Poss.3MSg razor beard-Poss.3MSg
ላጽዩላ ።
 laṣiy-u-la
 PerfS.shave-SM.3MSg-OM₂.3FSg
 ‘He shaved his beard with his grandmother’s razor.’

The suffix OM₂ in (133a) and (133b) corresponds to the instrumental applied objects *māhreša* ‘plough’ and *mālašä* ‘razor’. The affected object suffix OM₁ is used with verbs that lexicalize a path semantic role as a sub-sense of the instrumental semantic role reading. In Tigrinya instrument and path arguments are coded with the same preposition – *bi-* – in the oblique expression. The two concepts are unified in the wide semantic sense of ‘a means to accomplish something’. Like with the instrumental applied argument, the path applied object can also be coded through OM₁ or OM₂. For example, with the verb *ḥaläfä* ‘he passed’ the suffix OM₂ is used when the applied object is understood as a mere passage or path (134a), and OM₁ is used when the applied object is understood as an affected object, as in (134b).

- (134) a. ነዛ መንገዱ ትማሊ ማካይን
 n-äz-a mängäddi timali makayin
 Obj-DetProx-3FSg road yesterday cars
ሐሊፈናላ ነይረን ።
 ḥalif-än-ala näyr-än
 Perf-pass-SM.3FP1-OM₂.3FSg Past.be-SM.3FP1
 ‘Cars passed by/through this road yesterday.’
- b. ዮናስ ትማሊ ሐሊፈና ነይሩ ።
 yonas timali ḥalif-u-na näy-u
 Yonas yesterday Perf-pass-SM.3MSg-OM₁.1PI Past.be-SM.3MSg
 ‘Yonas passed/dropped by us yesterday.’

In (134a) the suffix OM₂ codes a path semantic role which is interpreted as an extended course or direction over which something moves. In (134b) OM₁ is perceived as a stopping point on the course or path that one passes by leaving it behind.

The affectedness reading results from the notion of telicity, since the affected path is understood as a completed course, a point that is completely covered.

The verb *gäzʔä* ‘he bought’ can code an instrumental argument with either OM₁ or OM₂, and the resulting applied objects are semantically distinct, as in (135).

- (135) a. ነቲ ገንዘብ መጽሐፍ ገዘኡሉ ።
 nä-t-i gänzäb mäṣḥaf gäziʔ-u-lu
 Obj-Det-3MSg money book.Sg Perf.buy-SM.3MSg-OM₂.3MSg
 ‘He bought a book with the money.’
- b. ነቲ ገንዘብ መጽሐፍ ገዘኡዎ ።
 nä-t-i gänzäb mäṣḥaf gäziʔ-u-wo
 Obj-Det-3MSg money book.Sg Perf.buy-SM.3MSg-OM₁.3MSg
 ‘He bought a book with the money.’

In sentence (135a) the use of the suffix OM₂ denotes that the applied object is used as a mere device in the transaction of buying without giving any appraisal of its engagement or affectedness. The applied object in this clause can also have a partitive interpretation which lexicalizes the meaning that only some of the money is used in the transaction. In contrast, the applied object in (135b) is understood as an affected object in the sense that every single penny is spent in the transaction. This meaning is coded via OM₁.

4.4.5 Source

Source applied objects can also yield different affectedness readings based on the form of the object suffix. For example, the verbs *säräqä* ‘he stole/robbed’ can host OM₁ for a directly affected applied object, or OM₂ for a partly or incidentally affected applied object, as in (136a).

- (136) a. እቲ ሰብኣይ ነታ ንል ገንዘብ
 ?it-i säbʔay n-ät-a g^wal gänzäb
 Det-3MSg man Obj-Det-3FSg girl money
 ሰሪቋዎ ።
 säriq-u-wa
 PerfS.steal/rob-SM.3MSg-OM₁
 ‘The man robbed the girl of money.’
- b. እቲ ሰብኣይ ነታ ንል ገንዘብ
 ?it-i säbʔay n-ät-a g^wal gänzäb
 Det-3MSg man Obj-Det-3FSg girl money
 ሰሪቋላ ።
 säriq-u-la
 PerfS.steal/rob-SM.3MSg-OM₂.3FSg
 ‘The man stole money from the woman.’

The two applied object readings expressed via OM₁ and OM₂ can be compared to the different semantic role readings lexicalized by the verb *rob* and *steal* in English. The former verb lexicalizes the person that their property is taken away from, the maleficiary, as the primary affected argument, whereas the latter verb lexicalizes the property that is taken away, the theme, as the primary affected argument. Similarly, in (136a) the verb expresses a completely affected source applied object reading with OM₁. The person who is robbed is perceived as being directly affected by the action described in the verb. In contrast, in (136b) the verb expresses a partially affected source applied object with OM₂. The incidentally or partly affected objects is understood as a mere source argument from whom money is taken.

4.4.6 Experiencer

Experiencer applied objects result from certain classes of psych verbs which are subcategorized for an experiencer argument with the object suffix OM₁. Accounting for experiencer applied objects is not a straightforward task. Below we identify three types of applicative clauses based on the type of semantic role reading of the initial argument of these psych verbs.

Type 1: These clauses involve psych verbs that are initially subcategorized for a subject and an applied object. The subject is interpreted as a non-referential or an external/implicit causer. The applied object corresponds to an experiencer argument role. Psych verbs which exhibit this behavior include: *čänäqä* ‘it stressed’, *ħarbätä* ‘it has become tough to’, *šägämä* ‘it inconvenienced’, *šägärä* ‘it troubled’, *šaǧälä* ‘it worried’, *gärämä* ‘it amazed’, *ṭiyamä* ‘it pleased’ and *dänäqä* ‘it astonished’. Example (137) illustrates this type.

- (137) a. *ኣኅ ሸጊረ ።
 ʔanä šägir-ä
 Pro.1Sg PerfS.trouble-SM.1Sg
 ‘I am troubled.’
- b. ኩነታት/*ቁልፍ ሸጊሩኒ ።
 kunätat/qolʔa šägir-u-ni
 situation/*baby PerfS.trouble-SM.3MSg-OM₁.1Sg
 ‘The situation/*baby troubled me.’
- c. (ኣነ/ንግድ) ሸጊሩኒ ።
 ʔanä/ni-ʔay šägir-u-ni
 Pro.1Sg/Obj-Pro.1Sg PerfS.trouble-SM.3MSg-OM₁.1Sg
 ‘I am in trouble./ Lit. It troubled me.’

The initial argument cannot be associated with an animate referent to express an experiencer reading (137a). It cannot also be associated with an animate explicit referent to express a causer reading (137b). Thus, animate referents such as ‘baby’ can only be coded as external causers with an overt causer morpheme, as in *ʔa-šägir-u* ‘he caused trouble’, and the subject suffix *-u* associates with the external causer. The subject is regarded as some sort of implicit ‘cause’, an entity that triggers certain psychological discomfort such as life situations, the weather or environmental conditions. In addition, the verb requires an object suffix to code an applied experiencer argument in order for it be a wellformed predicate (137c). Since the experiencer is the most salient and semantically prominent argument, the objective case becomes optional with experiencer applied objects.

Type 2: These psych verbs are ordinary intransitive verbs that are subcategorized for a subject argument which bears a theme semantic role. These verbs may get an experiencer argument through the verbal suffix OM₁. Examples of these verbs include: *šämawä* ‘it became quiet’, *käfʔä* ‘it became ugly/bad/unpleasant’, *märärä* ‘it became bitter/hot(spicy), *däharä* ‘it has become hot’, *käfʔä* ‘it became bad/unpleasant’, *ziḥalä* ‘it froze’.

- (138) a. **እዚ ከተማ ጸሚዩ ።**
 ʔiz-i kätäma šämmiy-u
 DetProx-3MSg city PerfS.quieten-SM.3MSg
 ‘This city became quiet.’
- b. **እቲ ገዛ/*ቆልዓ ጸሚዩ ።**
 ʔit-i gäza/*qolʔa šämmiy-u
 Det-3MSg house/baby PerfS.become=quiet-SM.3MSg
 ‘The house/*baby became quiet.’
- c. **(እነ/ነጻይ) ጸሚዩኒ ።**
 (ʔanä/ni-ʔay) šämmiy-u-ni
 (Pro.1Sg/Obj-Pro.1Sg) PerfS.quieten-SM.3MSg-OM₁.1Sg
 ‘I feel lonely./ Lit. It quietened to me.’

Example (138a) is an intransitive clause. The subject suffix codes a theme semantic role which corresponds to the subject nominal *ʔizi kätäma* ‘this (M) city’. Type 2 verbs select subjects that denote inanimate entities such as locations (house, street, town, etc.). Thus, animate subjects such as *ʔiti qolʔa* ‘the (M) baby’ cannot be selected by this verb, and consequently the subject argument cannot be interpreted as an experiencer (138b). In (138c), the subject suffix is understood to code an assumed cause of the experience that the referent of the applied object undergoes, and the object suffix codes an experiencer applied argument. The objective

case is optional as with applied objects of Type 1 psych verbs.

Type 3: These psych verbs result from regular intransitive verbs that are sub-categorized for an experiencer subject. However, when the experiencer argument is coded as an applied object through the suffix OM₁, the subject suffix codes a non-referential subject that has a third person masculine singular agreement feature. Verbs that exhibit this behavior include: *ṭämäyä* ‘he has become hungry’, *ṣämiṯä* ‘he has become thirsty’, *däḵämä* ‘he has become tired’ and *q^wärärä* ‘he has become cold’. This type of experiencer object construction is illustrated in (139).

- (139) a. **ኣኅ ጠፎየ ።**
 ṽanä ṭämy-ä
 Pro.1Sg PerfS.hungry-SM.1Sg
 ‘I am hungry.’
- b. **ኣኅ/ኅዳይ ጠፎየኒ ።**
 ṽanä/ni-ṽay ṭämy-u-ni
 Pro.1Sg/Obj-Pro.1Sg PerfS.hungry-SM.3MSg-OM₁.1Sg
 ‘I am hungry./ Lit. It hungered me.’

The experiencer argument of this verb is coded as a subject in (139a). In contrast, in (139b) the experiencer argument is coded as an applied object via the suffix OM₁, while the subject suffix in the applied predicate codes a non-referential subject. The subject of this applicative clause is understood to be a psychological state or circumstance that the experiencer applied objects undergoes.

The syntactic category of the experiencer argument and the argument-hood of the assumed ‘argument’ which is coded through the subject suffix have been the center of a long-standing debate in various studies that deal with psych verb constructions. Some suggest that the argument coded with the subject suffix be regarded as some sort of ‘cause’ semantic role which is also known as *emotional weather* (Pesetsky 1995:109). According to Pesetsky (1995) emotions like surprise, annoyance, and amusement have qualities similar to the weather, in that they affect the individual’s perceptions and actions globally. Thus, he says that the “proximate cause of both weather and emotions can be viewed as a force of nature, beyond the conscious control of the individual” (Pesetsky 1995:111). Commonly, the subject does occur overtly in the clause due to the fact that the filler of the cause argument belongs to semantic domains such as mental, emotional, physical or environmental conditions which are perceived as obvious to the listener, and the meaning of the psych verb itself is suggestive of the causes which Amberber (2005:310) terms as the ‘bona fide’ arguments of the predicate. Amberber considers Amharic experiencer arguments that result from these types of verbs as having quirky subject

properties, i.e. as non-canonically coded subjects. It is not clear how he accounts for experiencer subjects, though, since he argues that they are topics. Following Jackendoff (1990), Amberber (2005:311) proposes the Lexical Conceptual Structure *x causes y to be P* (e.g. be worried, stressed) to represent Amharic psych verbs. Amharic and Tigrinya verbs code an experiencer argument in a similar fashion, as in (140).

(140) a. Amharic (Amberber 2005:304)

ኣስቲር(ን) ጨነታት ።
 ?aster(-in) čänäqä-at
 Aster-(Acc) Perf.worry-SM.3MSg-OM₁. 3FSg
 ‘Aster is worried./ Lit. It worried Aster.’

b. Tigrinya

(ን)ኣስቲር ጨነቐዎ ።
 (ni-)?aster čäniq̄-u-wa
 (Obj-)Aster PerfS.become=tense-SM.3MSg-OM₁. 3FSg
 ‘Aster is stressed/worried./ Lit. It has become tense to Aster.’

c. Tigrinya

***(ን)ኣስቲር ጨነቐ ።**
 (ni-)?aster čäniq̄-a
 (Obj-)Aster PerfS.(become-tense)-SM.3FSg
 ‘Aster is worried/stressed./ Lit. It has become tense to Aster.’

The Amharic verb *čänäqä* and the Tigrinya verb *čänäq̄ä*, which mean ‘it has become tense’, are etymologically related. They also encode the same kind of arguments which are morphologically coded in the same manner in both languages: the object verbal suffix corresponds to the experiencer/causee argument and the subject suffix marks the implicitly hinted theme/cause argument. The preposed object NPs are optionally marked with objective case *ni*. In Amharic *-ni* functions only as an accusative case marker and appears as a suffix, whereas in Tigrinya *ni* functions as both an accusative and dative case marker and appears as a prefix. The OM₁ is obligatory in both languages. As example (140c) shows, if the object suffix is omitted, the clause becomes ungrammatical.

Experiencer applicative clauses with overt causer subjects are characterized by OSV word order (141).

(141) **(ን)ኣስቲር ሰና ኣቐንዚያዎ ።**
 (ni-)?aster sinn-a ?a-ḳ̄^wänziy-u-wa
 (Obj-)Aster tooth-Poss.3FSg Caus-PerfS.pain-SM.3MSg-OM₁.3FSg
 ‘Aster her tooth is paining her.’

The experiencer argument is a preposed topic applied object. The OSV word order that characterizes applicative constructions with experiencer objects is also common with applicative constructions that result from intransitive verbs. In experiencer object constructions the preposed object NPs are optionally marked with the objective case *ni-*, a property that is also exhibited by applied object NPs of intransitive verbs (142a). This suggests that the preposed applied objects are topics. The verbal suffix that corresponds to the applied object is obligatory since an applied object can only be subcategorized by virtue of the object suffix.

- (142) a. ነታ ሰበይቲ ከልቢ ሞይቱዋ ።
 (n-)ät-a säbäyti kälbi moyt-u-wa.
 (Obj-)Det-3FSg woman dog PerfS.die-SM.3MSg-OM₁.3FSg
 ‘A dog died on the woman.’
- b. ነ(እዛ) ሰበይቲ ጸሚዩዋ ።
 (n-)äz-a säbäyti şämmy-u-wa.
 (Obj-)DetProx-3FSg woman PerfS.quieten-SM.3MSg-OM₁.3FSg
 ‘This woman feels lonely. /Lit. It quietened to this woman.’

Both the intransitive applicative (142a) and the experiencer applicative construction (141) exhibit OSV word order, and the objective case marker *ni-* is optional for both the maleficiary and the experiencer NPs. Moreover, the verb cannot code a maleficiary or an experiencer argument unless they are marked by the suffix OM₁. A similar coding property is also exhibited by predicates that code an experiencer/maleficiary argument metaphorically. Let us consider the following sentences in (143), for example.

- (143) a. (እነ/ንግዳ) ሕልናይ ግሪቡኒ ።
 (?anä/ni-፡ay) ḥilna-y ፡arib-u-ni
 (Pro.1Sg/Obj-Pro.1Sg) spirit-Poss.1Sg PerfS.blacken-SM.3MSg-OM₁.1Sg
 ‘I am tired/exhausted./ Lit. My conscience/spirit blackened on me.’
- b. (እነ/ንግዳ) ግቕለይ
 (?anä/ni-፡ay) ፡aqlä-y
 (Pro.1Sg/Obj-Pro.1Sg) patience-Poss.1Sg
 ጸቢቡኒ ።
 şäbib-u-ni
 PerfS.narrow-SM.3MSg-OM₁.1Sg
 ‘I am stressed/suffocated./Lit. My patience narrowed on me.’
- c. (እነ/ንግዳ) ደመይ ፈሊሑኒ ።
 (?anä/ni-፡ay) dämä-y fälilḥ-u-ni
 (Pro.1Sg/Obj-Pro.1Sg) blood-Poss.1Sg PerfS.boil-SM.3FSg-OM₁.1Sg
 ‘I am angry./Lit. My blood boiled in/inside me.’

- d. (ኣነ/ገግይ) ርእሰይ ዘይሩኒ ።
 (ʔanä/ni-ʕay) riʔsä-y zäyi-u-ni
 (Pro.1Sg/Obj-Pro.1Sg) head-Poss.1Sg PerfS.whirl-SM.3FSg-OM₁.1Sg
 ‘I am confused./Lit. My head whirled on me.’

The OM₁ corresponds to the maleficiary, which can also have an experiencer argument interpretation. The experiencer argument can use either a subject or an object pronoun for its nominal expression, or can also be dropped from the clause. The subject suffix corresponds to the overtly expressed subject referents *hiina-y* ‘conscience’, *ʕaqlä-y* ‘patience’, *dämä-y* ‘blood’, *riʔsä-y* ‘head’ respectively. Since these subjects are perceived as generic entities, they must be indefinite. The indefiniteness of these arguments is motivated by their relative lack of importance in the discourse event. In contrast, the experiencer/maleficiary object arguments are the most prominent participants in the discourse event, thus they are portrayed by definite referents. Their importance in the discourse event is also morphosyntactically indicated by the obligatory clause initial position, the obligatory pronominal suffix and the optional case marking *ni-*.

4.4.7 Possessor

We assume that the derivation of a possessive expression is also an applicative phenomenon. The possessor expression is derived by applying the suffix OM₁ to the locative copula. The derivation of possessive expressions from existential copula is a widely observed phenomenon (Heine 1997). Let us first consider the coding of the locative as an oblique argument in a copula construction (144).

- (144) a. ኣቲ መጽሓፍ ኣብ ጣውላ ኣሎ ።
 ʔit-i mäṣṣhaf ʔab ʔawla ʔall-o
 Det-3MSg book Loc table Pres.exist-SM.3MSg
 ‘The book is on the table.’
- b. ኣብ’ቲ ገዛ ሰብ ኣሎ ።
 ʔab’t-i gäza säb all-o
 Loc’Det-3MSg house person Pres.exist-SM.3MSg
 ‘There exists a person in that house./ Lit. In that house exists a person.’

In (144a) and (144b) the locative (existential) copula verb takes a locative complement. The canonical position of the oblique locative is after the subject in the SOV word order as in the first example. However, the oblique locative can also be topicalized (144b). The copula verbs in these examples cannot bear OM₁, since the locative arguments are obliques.

In the applicative expression the locative copula codes the possessee subject through a verbal suffix, and the possessor through the object verbal suffix. The possessive expression is normally coded by OSV word order, as in (145).

- (145) a. (ን)እታ ገዛ ስብ ኣሎዎ ።
 (n-)ät-a gäza säb ?all-o-wa
 (Obj-)Det-3FSg house person Pres.exist-SM.3MSg-OM₁.3FSg
 ‘The house has people./ Lit. (In) the house exists a person.’
- b. (ን)ሳባ ሕያዎይ ኣው ኣሎዎ ።
 (ni-)saba ḥiyaway ḥaw ?all-o-wa
 (Obj-)Saba kind.M brother Pres.exist-SM.3MSg-OM₁.3FSg
 ‘She has a kind brother./ Lit. A kind brother exists for her.’
- c. (ን)ሳባ ብዙሓት ኣሕዎት ኣለዉዎ ።
 (ni-)saba bizuḥat ?aḥwat ?allä-wu-wa
 (Obj-)Saba many brothers Pres.exist-SM.3MPI-OM₁.3FSg
 ‘Saba has many brothers./ Lit. Many brothers exist for Saba.’

The object suffix *-wa* in (145a) is associated with a locative argument. The inanimate referent ‘house’ can also be perceived as an abstract possessor. However, since the applied objects in (145b) and (145c) have human referents, they are interpreted as possessors. The subject suffix varies according to the agreement values of the possessee, for example, the marker *-o* coincides with the singular masculine subject ḥaw ‘brother’ (145b), and *-wu* with the plural masculine subject ?aḥwat ‘brothers’ (145c). These agreement patterns show that the subject suffix cannot be analyzed as an impersonal or an expletive subject maker. Moreover, the possessor NPs bear an optional case marker *ni-*. The objective case marker in these constructions is optional since the applied object is preposed to the topic position, which is canonically a subject position. As subjects are unmarked for case, the preposed applied objects resemble subjects by involving an unbound case marker. The applied object is the most topical element in possessive expressions. The possessee is constrained to be indefinite. Since possessors are semantically prominent and are more discourse salient than possesseees, they function as topics in these constructions.

4.5 Conclusion

In this chapter, we have described how applicative expressions are coded with some cross-linguistic examples and with extensive examples from Tigrinya. The applicative operation is viewed as a morphosyntactic coding of an altered discourse

construal. Languages that employ the applicative construction are observed to employ applicative morphemes that range from polysemous to monosemous, reflecting one-to-many or one-to-one correspondence with the semantic arguments they code. Tigrinya uses two types of object suffixes, OM_1 and OM_2 , which are underspecified for various applied semantic roles. The Tigrinya applicative data consistently shows that the two object markers, OM_1 and OM_2 , are associated with affected/implicated and unaffected/unimplicated applied objects, respectively.

CHAPTER 5

Transitivity in applicative clauses

5.1 Introduction

Transitivity is considered as one of the important parameters along which languages vary in their applicative constructions (Polinsky 2005, Peterson 1999). It is often used as a definitional property of the applicative operation. Another term that is related to transitivity, and which is also often used in the definition of the applicative, is *valency*.¹ Originally, valency is a chemistry term which refers to the capacity of an atom or group of atoms to combine in specific proportions with other atoms or groups of atoms. Its metaphorical use in linguistics is credited to the French linguist Lucien Tesnière who employed the term to refer to the capacity of a verb to combine with distinct arguments or valents (Crystal 1985). Thus, valency pertains to the number of arguments that a verb can control (Kulikov et al. 2006, Van Valin 2001, Dixon and Aikhenvald 2000). According to Van Valin (2001:92) arguments of a verb can be described in terms of syntactic and semantic valency. Syntactic valency refers to the core grammatical functions, i.e. subjects and objects (described in terms of direct and indirect or primary and secondary notions), whereas semantic valency refers to the semantic roles that are specified in the argument structure of a verb. Since semantic arguments can be expressed by non-core grammatical functions, the number of semantic arguments need not be the same as the number of syntactic

¹Valence is another term for valency. According to Matthews (2007) the term valency is a translation from French and valence is a translation from German.

functions. For example, the verb 'give' controls three semantic arguments, as an agent, a theme and a recipient, as well two or three syntactic arguments, depending on how the recipient semantic role is expressed, as core or oblique object.

Often the applicative operation, along with the causative, is described as a 'valency-increasing' or 'transitivity-encoding' device (Comrie 1985, Dixon and Aikhenvald 2000, Dixon and Vogel 2004). However, even though transitivity and valency coincide in describing some aspects of the applicative operation, since there are certain grammatical properties of the applicative operation that concern transitivity alone, care should be taken in using these terms to define the applicative operation. According to the distinction made by Van Valin (2001), the applicative operation increases the syntactic rather than the semantic valency of a verb. Moreover, a semantic role that is associated with an applied object may not even be a semantic argument of the base verb that the applied verb is derived from. The non-controlled semantic role becomes a syntactic argument of a verb when the verb bears an applicative morpheme for it. Therefore, the applicative operation can be characterized best as a syntactic valency-increasing device.

Similarly, transitivity involves complex grammatical phenomena, one of which is the disposition of a verb for allowing core object arguments. It is worthwhile to mention some of these complexities in order to clarify the significance of transitivity for applicative constructions. According to Traski (1999:322) transitivity denotes the kind of activity or process expressed by a sentence, the number of participants involved and the manner in which they are involved. Transitivity is also viewed as a grammatical feature with discourse-determined properties (Hopper and Thompson 1980). Along these lines, Næss (2007) defines transitivity as a type of grammatical relationship that encodes the distinctness of participants in a situation described by the clause. According to her view, a clause that involves a definite/individuated object encodes higher transitivity than a clause with an indefinite/unindividuated object since an action that is directed towards distinct/individuated objects is effectively carried over to completion and affects that distinct participant fully. The fact that languages employ special markers for distinct (individuated/definite) object functions reflects that morphosyntactic marking is more sensitive to transitivity than to the presence or absence of a second or third participant (Hopper and Thompson 1980:254). This approach goes beyond the traditional concept that views transitivity as a specific valency pattern of the root verb, i.e. the transitivity of the base verb without any valency-changing affixes (Payne 1985). The remainder of this chapter will explore the relevance of transitivity to

applicative clauses.

5.2 Transitive vs. intransitive clauses

Transitivity is customarily viewed as a type of syntactic configuration that correlates to a cluster of semantic properties in a given language (Kibort 2008). Verbs are categorized as intransitive, transitive or ditransitive based on the number of object arguments (0, 1 or 2) they code. This type of characterization mainly emphasizes the inherent transitivity property of verb roots. Clauses are also classified as intransitive, transitive or ditransitive based on the verb type they involve. For example, Dixon and Aikhenvald (2000:3) identify two types of universal clauses – transitive and intransitive, based on the type of predicates they contain. In their view, intransitive refers to a property of a verb with a single core argument that has an intransitive subject function (S), while transitive refers to a property of a verb with two core arguments which have a transitive subject function (A) and a transitive object function (O). In addition, both clause types can have a plain or extended subtype depending on whether a language allows an extended intransitive or transitive object (E), an object function with a special argument status. This is illustrated in the following synopsis (146) (Dixon and Aikhenvald 2000).

(146) *Clause type transitivity*

(a)	intransitive	S		
(b)	extended intransitive	S		E
(c)	transitive	A	O	
(d)	extended transitive	A	O	E

Dixon and Aikhenvald (2000:3) use A to code a subject whose referent is a volitional entity which can initiate and control an activity, and O to code an object whose referent is affected by the activity performed by the referent of the A function. However, S refers to the single argument of intransitive verbs without making reference to the semantic properties of the referent of S. E, which means ‘extension to core’, refers to the object that bears a recipient or beneficiary role, or an object that bears the dative case.

Here A and E are partially specified on semantic grounds. That is, E is described as a function that can bear a beneficiary or a recipient role regardless of how it is syntactically expressed, i.e. as a core object or an oblique. Dixon and Aikhenvald

(2000) derive marking schemes that sketch the various ways these functions may appear in languages. For example, languages may reflect varied coding behavior such as dative-shift, applicative or oblique to express the extended transitive (146d). In Kinyarwanda O and E show the same coding and syntactic properties, thus we can say that the referents of both objects are equally affected by the activity, whereas an applied object that results from a peripheral role (e.g. locative or instrumental) is coded differently than O, and its referent is not affected to the same extent as the referent of O. Chicheŵa presents a puzzling scheme since applied objects assume properties of O, while the original O (with the patient/theme semantic role) loses its transitivity or its primary object property. A classification such as the one in (146) would not adequately capture the different degrees of transitivity that applied objects reflect cross-linguistically.

The characterization of the applicative process as a transitivity process does not encompass the various transitivity effects that applicative morphemes produce cross-linguistically. The transitivity issue in applicative constructions concerns the various object properties that applied objects may acquire in contrast to the base or initial object of the verb. For example, Peterson (2007:61) speculates that the typological split with respect to applied objects reflected in the Bantu languages may be due to the different transitivity effects that the applicative marker produces in the applied verb. According to him, in languages such as Kinyarwanda the applied verb is a 'supertransitive' verb since the applicative construction contains two objects that reveal similar primary properties of objecthood. However, in languages such as Chicheŵa the applied verb is simply a 'mono-transitive', since only one object, i.e. the applied object, shows important traits that are characteristic of primary objects. As a result, in Chicheŵa the initial object of the verb loses most of its object properties. Therefore, in Chicheŵa the applicative marker has a rearranging effect, whereas in Kinyarwanda it may be viewed as a transitivity device.

Comrie (1985:313) identifies two kinds of transitivity effects that are produced by the applicative morpheme, as already mentioned in chapter 4.1. In some languages it effects a valency increase by bringing a new core object into the argument structure of a verb without affecting the grammatical category of the base object. In other languages the applicative morpheme effects rearrangement by changing the grammatical category of the base object. In the case where the applicative operation does not affect the agrammatical category of the base object of the verb, the applied object may or may not display the same grammatical properties as the base object. Thus, the applicative operation can be viewed as a transitivity operation

only when it increases the number of core object arguments as well as gives rise to an object that reflects transitivity properties similar to those of the base object. However, when the applied object assumes core object status, but does not display important traits that are characteristic of core object arguments, the applicative operation increases the syntactic but not the semantic transitivity of the clause. In the case where the applicative operation effects rearrangement, the applied object functions as a primary object, i.e. an object closely bound to the verb, and the base object functions as a secondary object. In some languages the applicative morpheme functions as an argument rearranging device. Yet, describing the applicative as a ‘valency-increasing’ operation seems more apt, since valency refers to the number of core arguments, i.e. arguments that are controlled by the verb. The applied object satisfies this description since the core objecthood of applied objects is the most fundamental condition in order for a construction to be termed an applicative.

Following the traditional characterization of the notion of transitivity, Hopper and Thompson (1980) state that transitivity is a global property of an entire clause which encodes the transfer of an action from an agent to a patient. This state of affairs is composed of various interacting functional factors that rank a clause in a transitivity continuum based on the number of transitivity features it codes. They identify parameters of transitivity composed of various components that reflect different facets of intensity with which an action is carried over from one participant to another (Hopper and Thompson 1980:252). Below we present the parameters that are most relevant to the applicative clause.

- *Participants*: at least two participants are required in order for an action to be transferred.
- *Kinesis*: An action with an endpoint (completed goal) may be effectively transferred from one participant to another, but a state cannot.
- *Aspect*: A telic action, an action with an endpoint, is carried out in its entirety and can affect a patient more intensely than an atelic action, one which does not have an endpoint.
- *Punctuality*: An action without a transitional phase between its beginning and end has a more intense effect on a participant than an on-going action which is carried out gradually.
- *Volitionality*: An action with a volitional agent has a more apparent effect on a patient than an action with a non-volitional agent.

- *Agency*: An action that involves participants with high agentivity properties is more effectively transferred than an action that involves participants with low agentivity properties.
- *Affectedness*: A clause with a completely or totally affected patient is higher in transitivity than a clause with partially affected or unaffected participants.
- *Individuation*: An action is effectively transferred to a patient which is referential and distinct from an agent and its own background as opposed to one with a non-referential and non-individuated patient.

It is obvious that not all of these elements can be found in one clause at once. Clause transitivity is defined as a continuum which is gradient, rather than a precise dichotomy or trichotomy distinguishing between ‘intransitive’, ‘transitive’ and ‘ditransitive’. According to Hopper and Thompson (1980:253) the more features of high transitivity a clause has, the more transitive it is. Three of these components, number of participants, affectedness and individuation of objects, directly concern objects. Other components address different facets of a clause, which is why transitivity is best regarded as a global property of a clause. These transitivity factors can manifest themselves through grammatical marking such as word order, case and agreement marking.

The transitivity issues that concern applicative constructions pertain to inherent verb root transitivity on the one hand, and to discourse motivated clause level transitivity on the other hand. Inherent verb root transitivity impacts the grammatical category of object functions that an applicative construction codes. Moreover, the significance of inherent verb root transitivity is reflected by the restrictions that some languages place on the applicative morpheme to attach or not attach to verbs with certain semantic specifications. Further, clause level transitivity concerns the semantic and discourse factors that motivate the choice of an applicative over other modes of expression that are available for the coding of arguments. For example, the preference of an applicative expression over an oblique expression is assumed to be discourse motivated. These two perspectives are discussed in detail in chapters 6 and 9. In the following section we will discuss the transitivity issues relevant to applicative constructions.

5.3 Applicative transitivity

Previous work has treated transitivity in applicative constructions with respect to two issues: the restrictions on the applicative morpheme due to the inherent transi-

tivity of a base verb and the transitivity effect of the applicative morpheme on the applied verb (Kiyosawa 2006, Peterson 1999, 2007, Polinsky 2005). It has been observed that some languages put restrictions on allowing applied semantic roles in general or certain applied semantic roles with intransitive, transitive or ditransitive base verbs. The constraints on the formation of the applicative from different verb types, i.e. intransitive (unaccusative, unergative), transitive and ditransitive, seem to be language dependent to a large extent. We note divergent tendencies of which type of verb is amenable to applicativization.

Applicative behavior in languages such as Chicheŵa (Baker 1988b:377), Tzotzil (Aissen 1983) and Bahasa Indonesia (Chung 1976) led Baker to assume that the formation of a beneficiary applicative based on intransitive verbs would be impossible in many languages. However, Alsina and Mchombo (1990:153) refute Baker's claim, and show that beneficiary applicatives can be formed out of intransitive bases in Chicheŵa.

Moreover, based on a recent survey of 83 languages, Polinsky (2005) observes that the number of languages that form a beneficiary applicative out of intransitive and transitive base verbs is much larger (16 languages) than that of languages which limit it to only transitive base verbs (4 languages). Further, she noted a common tendency in the languages she surveyed that about 49 of them allow both transitive and intransitive base verbs in applicativization. Examples of these are Abaza (O'Herin 2001), Amharic (Amberber 2000), Bajau (Donohue 1996), Barupu (Donohue 1994), Creek (Martin 2000), Hakha Lai (Peterson 2007), Motuna (Onishi 2000) and many others. However, there are also a few languages that restrict the applicative expression to transitive verbs only. Such a restriction has been observed in two languages: Abkhaz (Hewitt 1979) and Taiap (Kulick and Stroud 1992). In some languages, the restriction is mainly a matter of whether a verb shows an unaccusative or an unergative behavior, rather than being an intransitive or transitive.² In languages where this is the case, the general tendency is that unaccusative verbs resist applicativization, while unergative verbs allow it. For example, in Sesotho (Machobane 1989) Hakha Lai (Peterson 1999) and Halkomelem (Gerds 1988) there

²Unaccusative and unergative are two classes of intransitive verbs which differ with respect to agentivity and telicity. An unaccusative is a verb which involves a non-agent argument which cannot actively initiate an action, and the action is described to be telic. Verbs such as *melt*, *fall*, *freeze*, *emerge*, etc. exhibit this behavior. In contrast, an unergative verb involves an agent argument which can actively initiate an action, and the action has an atelic property. Verbs of this type include: 'jump', 'walk', *ran*, *laugh*, etc. (See Perlmutter (1978) and Levin and Rappaport Hovav (1995) for a more detailed description of these terms.)

seems to be a strong tendency to form applicative constructions from unergative verbs.

There are also languages that disregard the unaccusative and unergative distinction altogether. Nevertheless, these languages may distinguish applied objects that result from unaccusative and unergative verbs by the object properties they reveal when they are subjected to diagnostics such as passivization. Applied verbs that result from unergative verbs behave like transitive verbs that code an agent-like subject and a patient-like object. Thus, the applied objects that result from unergative intransitive verbs tend to behave like affected/undergoer objects with respect to the applied argument's behavior in passivization and morphological coding. As will be illustrated in section 5.3.1, Tigrinya reveals asymmetric properties of applied object arguments that result from these subclasses of intransitive verbs. However, not all applied objects of unergative verbs reflect an undergoer behavior under passivization. Some unergative verbs code agent-like subjects the actions of which are not directed towards other participants. For example, verbs such as *ḥambäsä* 'he swam', *saʕisʕä* 'he danced' or *bäkäyä* 'he cried' can code applied objects that have a locative, beneficiary or maleficiary reading, but they cannot code affected or goal applied objects. In contrast, verbs such as *säḥaḳä* 'he laughed', *g^wäyäyä* 'he ran', *käyädä* 'he went' and *bäšidä* 'he arrived' can code undergoer applied objects, in addition to a beneficiary or locative argument, since these verbs reflect lexical entailments of directionality.

Polinsky (2005) points out that a restriction that limiting an applicative formation exclusively to intransitive verb bases is a very rare phenomenon. Fijian (Dixon 1988), Wambaya (Nordlinger 1998) and Ngan'gityemerri (Reid 2000) are the only languages that have been identified to exhibit this behavior thus far. Ngan'gityemerri shows partial blocking since only the applicative suffixes for comitative and dative *-mi*, locative *-ngan* and maleficiary *-ngin* are restricted to intransitive verbs.

Additionally, some languages do not allow the applicative suffix with trivalent verbs. Examples of these include Sesotho (Machobane 1989), Yimas (Foley 1997:372) and Alambak (Bruce 1984). According to Foley, this restriction in Yimas is specified by a semantic property of the root verb. Since the root verb in Yimas can only code a maximum of three arguments, ditransitive verbs do not allow applicative formation. In general, there are many languages that allow applicative formation from transitive verbs as well as intransitive verbs regardless of the unaccusativity or unergativity of the verb.

The second issue that has been treated extensively in research on applicative constructions is the kind of transitivity effect that the applicative morpheme brings about on the applied verb. The way languages lexicalize the arguments of the base verb has an effect on the morphosyntactic entity, i.e. the applied verb, formed by the applicative operation. In some languages, the way in which an applied object is semantically related to the base verb is signaled by the type of applicative markers employed to code it. For example, Salish languages are typologically noted for their use of relational and redirective applicative suffixes. Relational suffixes attach primarily to intransitive verbs, whereas redirective suffixes attach primarily to transitive verbs (Kiyosawa 2006, Gerdts and Kiyosawa 2007, 2005). In these languages, transitive verbs are overtly marked with a transitive marker. When the transitive verb bears the applicative suffix, the applied verbs also bear the transitive marker. Nevertheless, the applied verb formed out of a transitive base does not become a ditransitive, since the common tendency in these languages is that the lexical structure of a transitive verb can only code one core object argument. Therefore, in redirective applicatives only the applied object is coded as a core object, and thus occurs as a bare NP. Consequently, the initial object argument of the verb changes its category from NP to PP, assuming an oblique function. Thus, this kind of coding property indicates the different degrees of transitivity that the applicative suffix may effect on the applicative clause. Thus, the variability of object behavior is assumed to be a consequence of the lexical semantics and morphological structure of verbs (Peterson 2007). Dixon and Aikhenvald (2000:13) observe different transitivity effects that applicatives can produce cross-linguistically. This is summarized in the following prototypical schemas with intransitive and transitive applicatives.

EITHER

- a. Applicative applies to an underlying intransitive clause and forms a derived transitive.
- b. The argument in underlying S function goes into A function in the applicative.
- c. A peripheral argument (which could be explicitly stated in the underlying intransitive) is taken into the core, in O function.
- d. There is some explicit formal marking of an applicative construction, generally by an affix or some other morphological process applying to the verb.

OR

- a. Applicative applies to an underlying transitive clause and maintains transitivity, but with an argument in a different semantic role filling O function.
- b. The underlying A argument stays as it is.
- c. A peripheral argument (which could be explicitly stated in the underlying intransitive) is taken into the core, in O function.³
- d. The argument which was in O function is moved out of the core into the periphery of the clause (and may be omissible).
- e. There is some explicit formal marking of an applicative construction, generally by an affix or some other morphological process applying to the verb.

The first schema describes the pattern of applicatives formed out of intransitive verbs. It instantiates a pattern where the applicative operation gives rise to applied objects with an O function. In this pattern the applicative operation functions as both a valency-increasing and transitivizing device. However, in some languages since applied objects cannot assume an O function, they maintain their E property. The second schema describes another possible applicative pattern that results from transitive base verbs. The transitivity of the base verb is not affected (a), in the sense that the applied verb does not become a ditransitive, but the mapping of the objects to semantic roles is rearranged, i.e. the object with the O function (applied object) bears a semantic role other than that of a theme/patient (e.g. beneficiary, maleficiary or goal). The applied object is the primary object, and the initial object of the base verb either becomes a secondary object (c), as in Chicheŵa, or is expressed as a peripheral argument (d), as in Halkomelem and Lillooet, both Salish languages (Kiyosawa 2006, Gerdts 1988). These schemas represent only some of the patterns that are found in applicative constructions. There are also two other patterns formed out of transitive base verbs that are very common cross-linguistically. In one of these types both the applied and the base object are coded as O functions, and in the second type, the initial object of the verb remains as the primary object (O) and the applied verb assumes the secondary object function (E).

Applicative and passive are both topicalization strategies that foreground arguments with high discourse salience. These constructions differ in the categories

³We find the applicative pattern in (c) confusing. Since the applicative formation in this schema involves transitive verbs, the clarification given in parentheses does not seem to make sense. Dixon and Aikhenvald (2000) probably intended 'underlying transitive' instead of 'underlying intransitive'.

of grammatical functions which they target. The applicative operation foregrounds arguments or adjuncts that are distantly related to the verb by coding them as core object functions, whereas the passive construction foregrounds core object arguments to be coded as subject functions. Thus, the former effects advancement to core objecthood, while the latter effects advancement to subjecthood. That is why passivization serves as a diagnosis of primary objecthood, since only core objects functions are expected to passivize, or more specifically only objects that show primary traits of objecthood or objects arguments that code semantic affectedness. In an applicative clause, the applied argument is the most prominent object in the discourse event. Thus, it is usually considered to be the most affected argument. However, in some languages applied objects with certain semantic properties resist passivization; instead, only the initial object arguments (theme/patient) are disposed to passivize. Therefore, in these languages the discourse notion of affectedness does not appear to correlate to the semantic notion of affectedness. The distinction of semantic roles as *participatory* and *circumstantial* made by Andrews (1985:69) correctly characterizes the notion of affectedness as a result of actual participation in the situation implied by a verb (e.g. beneficiary and instrumental) and participation by becoming part of the setting of the event (e.g. theme/patient and recipient), respectively. Object diagnostics are discussed in chapter section 8.2. This distinction is very clear in the applicative data from Tigrinya which we will discuss in the following section.

5.3.1 Applicative transitivity in Tigrinya

In this section we will investigate applicative constructions in Tigrinya in terms of transitivity. As already mentioned, the transitivity properties of applicative constructions have semantic and discourse dimensions. There are semantic factors such as the lexical entailments of the verb and the semantic type of the argument filler, and discourse properties such as individuation and referentiality of arguments, which determine the grammatical realization of an argument (Levin and Rappaport Hovav 2006:62). As was already mentioned, the applicative coding of an argument is motivated by its discourse topicality. The referents of applied objects correspond to definite and individuated entities. Many languages seem to differentiate between applied objects that are affected by lexical entailments imposed by a base verb's semantic properties and applied objects that are perceived as affected because of their participation in the discourse event. As was already discussed in section 4.4, Tigrinya distinguishes between directly affected applied objects coded by OM₁ and

incidentally affected applied objects coded by OM_2 . For example, recipient applied objects are coded as affected objects similar to patient/theme arguments since their involvement is inherent in the concept of the predicate, whereas beneficiary applied objects are coded differently from affected objects since they have a peripheral role in the event described by the verb. In other words, their participation is not inherent in the concept of the predicate. Even though both recipient and beneficiary applied objects are coded as core objects by virtue of the applicative operations and are consequently granted topic status, they show variation in the degree of affectedness/transitivity they code. As we shall see, the semantic and discourse notions of affectedness do not always seem to correlate in Tigrinya.

In the previous section we noted that languages vary with respect to the semantics of the base verb they allow for the formation of applicatives. Applicative constructions are commonly analyzed with respect to verb class coefficients such as intransitive, transitive or ditransitive verbs. According to Bybee (1985:30) the distinction between inherently (or semantically) transitive and inherently intransitive verbs is cross-linguistic. Even those languages that employ transitive markers to derive transitive verbs out of intransitives contain verbs that are basically intransitive and transitive. Tigrinya has inherently intransitive, transitive and ditransitive verbs. However, as has been observed in many other languages, there are also some verbs that are not easy to classify in discrete categories. For example, not all ditransitives reflect the same degree of (di)transitivity. Verbs such as *(wä)habä* ‘he gave’ and *ʕaddälä* ‘he distributed’ exhibit higher transitivity than *wäfäyä* ‘he donated’ and *sädädä* ‘he sent’. Consequently, the applied objects that result from the former verbs are coded as directly affected objects (marked with OM_1), whereas the applied objects that result from the latter verbs are coded as incidentally affected objects (marked with OM_2). In the following section we will adopt the intransitive, transitive and ditransitive coefficients to analyze argument realization and transitivity in Tigrinya.

5.3.2 Applicative formation and base verb transitivity

In general, Tigrinya allows applicatives to be formed out of ditransitive, transitive and intransitive base verbs. Applied verbs of prototypical ditransitive verbs such as *hib-u-la* ‘he gave for/with her/it(fem)’ and *ʕaddil-u-la* ‘he distributed for/with her/it(fem)’ can lexicalize up to four semantic arguments: agent, theme, recipient and beneficiary/maleficiary/instrumental, in their argument structure. However, a maximum of two object arguments can be coded as core object functions in a clause.

- (147) a. እቲ መምህር ንሳባ ንተመሃሮ መጽሓፍቲ
 ʔit-i mämihir ni-saba ni-tämähar-o mäṣṣhaf-ti
 Det-3MSg teacher.Sg Obj-Saba Obj-student-Pl book-Pl
 ዓዲሉላ ።
 ʔadil-u-la
 PerfS.distribute-SM.3MSg-OM₂.3FSg
 ‘The teacher distributed books to students for Saba.’
- b. እቲ መምህር ነቶም ተመሃሮ መጽሓፍቲ
 ʔit-i mämihir n-ät-om tämähar-o mäṣṣhaf-ti
 Det-3MSg teacher.Sg Obj-Det-3MPl student-Pl book-Pl
 ዓዲሉዎም ።
 ʔadil-u-wom
 PerfS.distribute-SM.3MSg-OM₁.3MPl
 ‘The teacher distributed books to the students.’

With prototypical ditransitive verbs the suffix OM₂ corresponds to beneficiary, maleficiary, instrumental or locative applied objects, as in (147a). The applied object precedes the recipient object and the theme object. Both the applied and the recipient objects are marked with the objective case. The suffix *-la* can be associated neither with the recipient nor with the theme objects since these are coded with the suffix OM₁, as in (147b). With such prototypical ditransitive verbs only OM₂ increases the semantic valency of the verb. In contrast, in (147b) the suffix OM₁ codes a recipient applied object whose concept is inherently present in the meaning of the verb. For this reason, the applicative process coded through OM₁ does not increase the semantic valency of the ditransitive verb, but since the recipient argument is coded as a core object function, the applicative suffix increases the syntactic valency of this verb.

Some ditransitive verbs allow only the suffix OM₂ to mark an applied object. For example, verbs such as *wäfiy-u-la* ‘he donated to/for/with(instrument) her/it(fem)’, *sädid-u-la* ‘he sent to/for/with(instrument) her’ and *šäyit-u-la* ‘he sold to/for/with(instrument) her’ may bear the suffix OM₂ for a recipient, a beneficiary, a locative, an instrumental, a goal or a source semantic role. The recipient/goal applied objects that result from some of these verbs are coded similarly to locative, instrumental or source applied objects. This may suggest that these applied verbs code a lower degree of transitivity than applied verbs of prototypical ditransitive verbs, and that these verbs are found on the borderline between prototypical ditransitive verbs and transitive verbs with regard to the semantic and syntactic properties of their applied objects. For example, transitive verbs such as *gäziʔ-u-la* ‘he bought for/from/with(instrument) her/it(fem)’ and *bäliʔ-u-la* ‘he ate for/in/on/with her/it(fem)’ allow only the suffix OM₂ to code applied objects. Example (148) il-

illustrates the ways in which these types of verbs are similar.

- (148) a. **እቲ ወዲ ነታ ሰበይቲ ገንዘብ**
 ʔit-i wäddi n-ät-ä säbäyti gänzäb
 Det-3MSg boy Obj-Det-3FSg woman money
ወፊዮላ ።
 wäfiy-u-la
 PerfS.donate-SM.3MSg-OM₂.3FSg
 ‘The boy donated money to/for a woman.’
- b. **እቲ ወዲ ነታ ሰበይቲ ገንዘብ ሰዲዱላ ።**
 ʔit-i wäddi n-ät-ä säbäyti gänzäb sädid-u-la
 Det-3MSg boy Obj-Det-3FSg woman money PerfS.sent-SM.3MSg-OM₂.3FSg
 ‘The boy sent money to/for a woman.’
- c. **እቲ ወዲ ነታ ሰበይቲ ቅጭ በሊዮላ ።**
 ʔit-i wäddi n-ät-ä säbäyti qiča bäliʕ-u-la
 Det-3MSg boy Obj-Det-3FSg woman bread PerfS.eat-SM.3MSg-OM₂.3FSg
 ‘The boy ate bread for/on a woman.’

The applicative suffix OM₂ is associated with a recipient/beneficiary in (148a) and with a recipient/goal in (148b), among other ranges of semantic role readings such as an instrumental, a locative or a source. Even though the recipient in *wäfiy-u-la* and the recipient/goal in *sädid-u-la* are concepts that are lexically entailed by the verbs, they are coded like applied objects that arise from peripheral roles such as a beneficiary, an instrumental or a source of a transitive verb, as in (148c).

This suggests that the applicative suffixes OM₁ and OM₂ code a difference in the transitivity relationship. A recipient applied object of a prototypical ditransitive clause marked with OM₁ is interpreted as being directly implicated or highly affected. On the other hand, beneficiary, locative and instrumental applied objects of a ditransitive clause that are associated with OM₂ are indirectly implicated or less affected. Either the nature of the action described by the verb or by the semantic nature of the participants can yield this difference in transitivity. An applied object that arises from ditransitive verbs like *wäfiyā* ‘he donated’ and *sädidä* ‘he sent’ and transitive verbs *bäliʕä* ‘he ate’ is less affected. In terms of valency, the applicative marker increases the syntactic valency of prototypical ditransitive, transitive, and intransitive verbs, but it may or may not increase the semantic valency of these verbs, since semantic valency increase in applicatives depends on whether the applied object is assigned a semantic role that is conceptualized in the lexical meaning of a base verb or not.

Both types of applicative suffixes (OM₁ and OM₂) may attach to both unaccusative and unergative intransitive verbs, as in (149). Unaccusative verbs such

as *māwätä* ‘he died’, *ṭäff?ä* ‘he/it disappeared’, *Ṡabäyā* ‘he/it grew up/became big’, *bäzḥä* ‘he/it flourished/multiplied/ became many’, *čänāwä* ‘he/it smelled’, etc., and unergative intransitive verbs such as *goyäyä* ‘he ran’, *mäs?ä* ‘he came’, *bäṣḥä* ‘he arrived’, *kä(yä)dä* ‘he went’, etc. can bear OM₁ or OM₂ to code various readings of applied semantic roles.⁴

- (149) a. **(ን)እታ ሰበይቲ እቲ ሕሙም ወዳ**
 (ni-)ʔi-a säbäyiti ʔit-i ḥimūm.MSg wädd-a
 (Obj-)Det-3FSg woman Det-3MSg ailing son-Poss.3FSg
መይት-ወ/ላ ።
 mäyit-u-wa/la
 PerfS.die-SM.3MSg-OM₁/OM₂.3FSg
 ‘Her ailing son died on/for the woman.’
- b. **(ን)እታ ሰበይቲ እቲ ሰክራም ሰብኣያ**
 (ni-)ʔi-a säbäyiti ʔit-i säkiram säbʔay-a
 (Obj-)Det-3FSg woman Det-3MSg drunken husband-Poss.3FSg
ጠፊኩ-ወ/ላ ።
 ṭäffit-u-wa/la
 PerfS.disappear-SM.3MSg-(OM₁/OM₂).3FSg
 ‘(The) her drunken husband disappeared on/for the woman.’
- c. **እታ ሰበይቲ ነቲ ቅልጻ ገዩያ-ቶ/ትሉ ።**
 ʔit-a säbäyiti n-ät-i qolʔa goyiy-a-to/tlu
 Det-3FSg woman Obj-Det-3MSg child PerfS.run-SM.3FSg-OM₁/OM₂.3MSg
 ‘The woman ran after the child./ The woman ran for the child.’
- d. **እታ ዓድዋ ዓድዋ እትብሉዋ ፡**
 ʔit-a ʔadwa ʔadwa ʔi-ti-bl-u-wa:
 Det-3FSg Adwa Adwa Rel-Imperf.2-call-MPI-OM₁.3FSg
ክትመጽኩም ድ’ያ ፡
 ki-t-mäs-ä-kum di’y-a:
 Purp-Imperf.3-come-SM.FSg-OM₁-2MPI Q’Pres.be-SM.3FSg
ክትከዱዋ?
 ki-t-käd-u-wa
 Purp-Imperf.2-go-SM.MPI-OM₁-3FSg
 ‘That what you call Adwa, Adwa, is she coming to you, or are you going to her?’⁵

⁴Some intransitive verbs can exhibit unergative or unaccusative properties depending on the semantic property of the referent of the subject argument they are associated with. For example, with inanimate referents as in *gize mäṣiʔu* ‘Time has come’, *gize bäṣiḥu* ‘Time has arrived’ or *gize käydu* ‘Time has gone’ they behave like unaccusatives.

⁵In this song Adwa is personified, thus it is coded as animate goal applied object. This example comes from the lyrics of a Tigrinya folk song which was used to rally recruits for the battle of Adwa which was fought between Italy and Ethiopia in 1896.

With unaccusative verbs there seems to be a tendency for the suffix OM₁ to be associated with ethically affected or maleficiary objects, whereas the suffix OM₂ is associated with beneficiary applied objects, as in (149a) and (149b), or locative or instrumental applied objects if the meaning of the verb allows the reading. With unergative verbs the OM₁ is associated with a goal or a directly affected object, whereas the OM₂ is associated with a beneficiary or a maleficiary applied object if the lexical meaning of the verb permits the reading. The applied goal in (149c) has an animate referent, but in (149d) the referent of the goal argument is personified in this literary discourse, thus it is considered as an animate entity. The verb *goyäyä* ‘he ran’ allows the affected object reading since the applied object is also engaged in the activity described by the verb. If a goal argument has a stationary inanimate entity as its referent, it cannot be expressed as an applied object; instead it is expressed in an oblique phrase, as in (150a). Moreover, goal applied objects of this type can only be associated with animate referents, as in (150b).

- (150) a. እታ ሰበይቲ ናብ እቲ ገዛ/ቀልጻ ገደያ ።
 ?it-a säbäyti ni?ab ?it-i gäza/qolfa gäyiy-a
 Det-3FSg woman towards Det-3MSg house/child PerfS.run-SM.3FSg
 ‘The woman ran towards/to the house/child.’
- b. እታ ሰበይቲ ነቲ *ገዛ/ቀልጻ
 ?it-a säbäyti n-ät-i gäza/qolfa
 (Obj-)3FSg woman Obj-Det-3MSg *house/child
 ገደያቶ ።
 goyiy-a-to
 PerfS.run-SM.3FSg-OM₁.3MSg
 ‘The woman chased/ran after the *house/child.’

The verb in (150a) does not bear any object suffix for the argument with the goal/locative role. This argument has an oblique function since the noun phrase that corresponds to it is case marked with the directional preposition *ni?ab*. Either an animate or an inanimate referent can serve as an argument of the oblique function in this example. In the applicative expression, however, only animate referents fill the affected goal argument slot. In (150b) the OM₁ can only be associated with the animate argument *qolfa* ‘child’ to mark an affected goal applied object. It is worth noting that the oblique expression of the locative argument in (150a) and the applicative expression of the goal argument in (150b) cannot be paraphrases of each other, since the two clauses imply different semantic readings – ‘to run to a place’ in the former and ‘to run after someone’ in the latter. A locative argument that is imposed by the lexical entailment of a predicate, as with verbs such as *?atäwä* ‘he entered/went in’ or *däyäbä* ‘he climbed (up)’, is coded as an affected applied object

with OM₁, as in (151).

- (151) a. (ን)እታ ዓዲ ወተሃደራት አትዮምዋ ።
 (ni-)ʔit-a ʕadi wätähadär-at ʔaty-om-wa
 (Obj-)3FSg village soldier-Pl PerfS.enter-SM.3MPI-OM₁.3FSg
 ‘Soldiers entered/went in the village.’
- b. (ን)እታ ቅሚጦ አጣል ደይበንአ ።
 (ni-)ʔit-a qimito ʔatal däyb-än-ʔa
 (Obj-)3FSg silage goats PerfS.climb-SM.3FPI-OM₁.3FSg
 ‘Goats climbed on the silage.’

The applicative suffix that is associated with applied object arguments that arise from the lexical entailments imposed by base verbs results in highly transitive applied verbs that code directly implicated or fully affected applied objects. The applied objects of such verbs exhibit object traits which are characteristic of primary objects (e.g. the affected locative arguments can function as subjects in passive constructions). However, the ability to code patient-like or directly affected applied objects cannot be attributed solely to the agentivity property of unergative verbs. There seem to be other semantic components that effect affectedness in applied objects of intransitive verbs. For example, unaccusative verbs of motion allow the applicative suffix OM₁ for an affected goal object. The notion of affectedness arises from the entailment of motion that these verbs lexicalize. Hence, the goal argument is perceived as the endpoint that receives the impact of the moving entity. For example, verbs such as *wädäqä* ‘he/it(masc.) fell’, *nätäbä* ‘he/it(masc.) dripped’, *ʕaläbä* ‘he/it(masc.) landed’, *läḥakä* ‘it(masc.) leaked’, *wähazä* ‘it(masc.) streamed’ and *fäsäsä* ‘it(masc.) flowed/surged’ bear the suffix OM₁ to code affected goal applied objects, as is illustrated in (152).

- (152) a. (ን)ዮናስ ዓባይ እምኒ ውዲቻቶ ።
 (n-)yonas ʕabay ʔimni wädiq̄-a-to
 (Obj-)Yonas big.SgF stone PerfS.fall-SM.3FSg-OM₁.3MSg
 ‘Yonas, a big stone fell on him.’
- b. (ን)እታ ዕንባባ አናህብ ዓሊቦምዋ ።
 (n-)ʔit-a ʕinbaba ʔanahib ʕalib-om-wa
 (Obj-)Det-3FSg flower bees PerfS.land-SM.3MPI-OM₁.3FSg
 ‘The flower, bees landed on it.’
- c. (ን)እታ ወረቆት ማይ ነጠቡዋ ።
 (n-)ʔit-a wäqät may näṭib-u-wa
 (Obj-)Det-3FSg paper water PerfS.drip-SM.3MSg-OM₁.3FSg
 ‘The paper, water dripped on it.’

The affectedness notion comes across regardless of the concept of the weight or speed of the moving entities. Indeed, the referents of the applied objects are por-

trayed as weak, light or delicate entities that are positioned lower than the referents of the subject arguments, and the referents of the subject arguments are portrayed as heavy and forceful elements. For example, in (152a) the stone can physically hurt the referent of the applied object, in (152b) the weight of bees can cause the flower to tilt and in (152c) the drop of water can cause the paper to flap or quiver and be stained - these qualities can only add intensity to the notion of affectedness. Even though the subject arguments of most of these verbs do not have agentive properties since they are not volitionally acting arguments, they have a potential to affect the thing they come in contact with because of their motion entailment. As is expected, these types of applied verbs cannot be passivized, conforming to the universally observed principle that the maximum degree of transitivity is coded by the action of an agent. However, not all unergative verbs can allow the applicative suffix OM₁ for a directly affected or ethically affected (maleficiary) object. For example, manner of motion verbs such as *ḥanbäsä* ‘he swam’, *saʿsiʿä* ‘he danced’, *ʔaṭaqiʿä* ‘he clapped’, *faṣäyä* and *sägädä* ‘he bowed’ do not allow the applicative suffix OM₁. Thus, with these verbs it is impossible to get affected applied objects. These verbs allow the suffix OM₂ for beneficiary/maleficiary, locative or instrumental/accompaniment applied objects, as illustrated in (153).

- (153) a. **ንእሽቶ ከለኹ ነዛ ሓጽቢ**
 niʔišto k-älä-ku n-ä-z-a ḥaṣbi
 young Adv-be-SM.1Sg Obj-Det-dexis-3FSg dam
ሓምቢሱ *ያ/ላ **ነይረ ።**
 ḥambis-ä-*ya/la näyr-ä
 PerfS.swim-SM.1Sg-*OM₁/OM₂.3FSg Past-be-SM.1Sg
 ‘When I was young, I had swum in this dam.’
- b. **እቶም ህዝቢ ብሓባር ነታ ባንዴራ**
 ʔit-om hizbi bi-ḥabar n-ät-a bandera
 Det-3MPI people with-unity Obj-Det-3FSg flag
ሰጊዶም *ዋ/ላ ።
 sägid-om-*wa/la
 PerfS.bow-SM.3MPI-*OM₁/OM₂.3FSg
 ‘The people bowed to the flag in unison.’
- c. **(ን)እታ ናይ ማዶና ደርሬ ምሉእ ለይቲ**
 (ni-)ʔit-a nay Madonna dārfi miluʔi läyti
 (Obj-)-Det-3FSg of Madonna song whole night
ሳዕሲዕና *ያ/ላ ።
 saʿsiʿ-*na*-*ya/la
 PerfS.dance-SM.1PI-*OM₁/OM₂.3FSg
 ‘We danced the whole night to the song of Madonna.’

The applicative suffix OM₂ in (153a), (153b) and (153c) codes locative, beneficiary and an accompaniment/instrumental applied objects, respectively. However, a goal argument cannot be applied with this type of verbs since they lack the transfer or transmission entailment in their lexical meaning. The action of an agent argument of these verbs cannot be transferred or transmitted to affect another object argument. In contrast, unergative and unaccusative verbs of motion that denote movement or displacement towards an endpoint entail this concept, thus they can affect the object they come in contact with. Some of these verbs describe a concept of motion that involves the whole body (e.g. *ḥambäsä* ‘he swam’ and *saſsäſä* ‘he danced’) or parts of the body (e.g. *sägädä* ‘he bowed’ and *ʔatäq̄iſä* ‘he clapped’) the of the agent argument, but this type of motion is not lexicalized as directed motion, since the agent does not move towards a specific endpoint. Intransitive verbs which describe internally caused eventualities behave similarly with respect to their behavior in applicativization. Verbs such as *ʔanbahaq̄ä* ‘he yawned’, *ḥarnäkä* ‘he snored’, *säſälä* ‘he coughed’, *ṭärät ä* ‘he farted (with noise)’, *fäsäwä* ‘he farted (without noise)’, *g^wäsſä* ‘he burped’, *wäččäčä* ‘he screamed’, *ʔalqäsä* ‘he mourned/wailed’ and *bäkäyä* ‘he cried’ do not allow the applicative suffix OM₁ for the reading of a genuine affected goal object. These verbs are commonly classified as unergative verbs even though some of these do in fact denote non-voluntary processes. They contain the concept of emission which Perlmutter (1978:163) describes as ‘non-voluntary emission of stimuli that impinge on the senses’. Their incompatibility with OM₁ seems to be due to the lack of a transfer entailment. Thus, they cannot allow a goal applied object that has a function of an endpoint towards which the different kinds of emissions - sound, light, smell or substance, can be directed or released. They can only be associated with OM₂ to code maleficiary or beneficiary applied objects depending on the meaning of the individual verb, as in (154).

- (154) **እቲ ቀለዕ ነታ ሰበይቲ ኣብ ኣፋ**
 ʔit-a qolſa n-ät-a säbäyti ab ʔaf-a
 Det-3FSg baby Obj-Det-3FSg woman on mouth-Poss.3FSg
ሰዒሉ-*ዋ/ለ ።
 siſil-u-*wa/la
 PerfS.cough-SM.3FSg-*OM₁/OM₂.3FSg
 ‘The child coughed towards the woman’s mouth.’

The verb in (154) can only allow OM₂, and the applied object can have a maleficiary or a locative semantic role reading. In contrast, since the verb *bäkäyä* ‘he cried’ denotes the concept of sound emission to express a negative emotion, it employs the suffix OM₁ to code a maleficiary or an ethically affected argument whose

referent is disadvantaged by the crying referent. In this respect, this verb behaves like unaccusative verbs such as *māwātā* ‘die’ and *ṭāfiʔā* ‘lose’. However, OM₁ cannot refer to a goal applied object since the verb *bākāyā* ‘cry’ does not conceptualize the idea of transfer to code genuine affectedness. The suffix OM₂ is associated with the beneficiary applied object. Example (155) illustrates this.

- (155) (ን)እታ ሰበይቲ ወዳ በኸዩ-ዋ/ላ ።
 (ni-)ʔit-a sābäyti wädda bākya-u-wa/la
 (Obj-)Det-3FSg woman son-Poss.3FSg PerfS.cry-SM.3MSg-OM₁/OM₂.3MSg
 ‘The woman, her son cried on/for her.’

The applicative suffix OM₁ codes a maleficiary applied object. The woman is perceived as being affected or sad because of the crying child. In contrast, the suffix OM₂ expresses a beneficiary applied object. The woman is perceived to be the referent to wards whom the sympathy of the crying child is directed. On the other hand, *sāḥaqā* ‘he laughed’, *kāmis bälä* ‘he smiled’ and *fišikbälä* ‘he beamed’ behave like unergative verbs that denote transmission of force to a recipient. These verbs allows both OM₁ and OM₂ to code applied objects. The OM₁ may code a goal, a stimulus, or a maleficiary applied object, whereas the OM₂ may code a maleficiary or a beneficiary applied object⁶, as is illustrated below (156).

- (156) እታ ጎል ነቲ ወዲ ስሒቻ-ቶ/ትሉ ።
 ʔit-a g^wal n-ät-i wädi siḥiq-a-to/tlu
 Det-3FSg girl Obj-Det-3MSg boy PerfS.laugh-SM.3FSg-OM₁/OM₂.3MSg
 ‘The girl laughed/smiled at the boy./The girl laughed for/mocked/ridiculed the boy.’

The verb *siḥaqā* allows the applicative suffix OM₁ to express a goal semantic role (the person to ward whom the laugh is directed), a stimulus/reason (the person who has been laughed at) or a maleficiary (the person who is mocked or ridiculed). The verb can also code a maleficiary or a beneficiary applied object reading with OM₂. The applicative operation effects an increase in both semantic and syntactic valency of unaccusative verbs of the type exemplified above (e.g. *māwātā* ‘he died’ and *ṭāfiʔā* ‘he disappeared’). Yet, even though an ethically affected or a maleficiary object is morphologically coded like a patient argument since it employs OM₁, it does not acquire properties that are characteristic of directly affected or patient

⁶Commonly, the maleficiary applied object reading is coded through OM₁ with intransitive base verbs, whereas it is coded via OM₂ with ditransitive and transitive verbs. OM₂ can also mark a maleficiary reading with intransitive verbs such as *siḥiqu-la* ‘he laughed at her’, with the intention of teasing her, *ʔalaḡi su-la* ‘he mocked her’. The maleficiary reading can also be interpreted as the abstract goal argument with this sort of verbs.

object arguments of monotransitive clauses (e.g. they cannot function as subjects in passive constructions). In contrast, a goal applied object of an unergative verb of motion or one that entails a transfer of emissions behaves like a patient object of monotransitive clauses (e.g. they can passivize since they code agent arguments which can be demoted by passivization). Therefore, when the applicative suffix is used with these verbs, it functions as a transitivizing device since it gives rise to an applied object that codes high transitivity properties. We summarize our discussion about the types of semantic roles that can be featured as directly or incidentally affected applied objects with respect to different verb types in Table 5.1, page 157.

Verb types		Object affectedness	
Types	Examples	directly affected (OM ₁)	incidentally affected (OM ₂)
Ditrans. Type 1	<i>wāhabā</i> ‘he gave’ <i>ʕadālā</i> ‘he distribute’ <i>māharā</i> ‘he taught’	th, rec th, rec th, goal	ben, mal, source, instr ben, mal, source, instr ben, loc, source,
Ditrans. Type 2	<i>nāgārā</i> ‘he told’ <i>wāfāyā</i> ‘he donated’ <i>wārwarā</i> ‘he threw/hurled’ <i>sādādā</i> ‘he sent’ <i>šāyātā</i> ‘he sold’ <i>ʔanbārā</i> ‘he put/placed’	th, goal th th th th th	ben, mal rec, ben, source goal, ben, mal goal, rec, ben, source goal, ben, mal, instr loc, ben, mal
Mono-trans.	<i>bālʕā</i> ‘he ate’ <i>ḥaṣābā</i> ‘he washed’ <i>qātālā</i> ‘he killed’ <i>gāzāʔā</i> ‘he bought’ <i>sārāqā</i> ‘he stole’	th th patient th, source th, source	ben, mal, loc, source, instr ben, loc, instr ben, source, loc ben, mal ben, source (inanim)
Unaccusative	<i>māwātā</i> ‘he died’ <i>ʔāfʔā</i> ‘he/it disappeared’ <i>wādāqā</i> ‘he fell’ <i>fāsāsā</i> ‘it spilled out’ <i>mākākā</i> ‘it melted’ <i>fālḥā</i> ‘he boiled’	mal mal goal, mal goal, mal goal, mal	ben ben ben ben, source ben ben, loc
Unergative	<i>g^wāyāyā</i> ‘he run’ <i>māṣʔā</i> ‘he came’ <i>kāyādā</i> ‘he left’ <i>sāḥaqa</i> ‘he laughed’ <i>bākāyā</i> ‘he cried’ <i>ḥanbāsā</i> ‘he swam’ <i>saʕsiʕā</i> ‘he danced’ <i>sāʕalā</i> ‘he coughed’	goal, mal goal, mal goal, mal goal, mal mal ∅ ∅ ∅	ben, path ben ben, instr ben, mal ben ben, loc, instr ben, loc, instr ben, mal

Table 5.1: Transitivity in applicatives

5.4 Concluding remarks

This chapter has focused on the transitivity aspect of the applicative clause. In previous works the applicative operation has often been characterized as a transitivity-increasing operation since by virtue of this process the verb acquires a new core object, the applied object. Thus far, however, we have argued that the applicative process does not always have a transitivity-increasing effect, since the new argument it brings about can also be a semantic argument of the base verb, for example, the locative argument of 'sit' and 'put'. Furthermore, it may be viewed as a syntactic valency-increasing device since it always increases the number of core grammatical functions by one. Moreover, we have also argued that the variation of applied object behavior is related to the difference in transitivity effects that the applicative morpheme brings about in languages. In some languages the applied object behaves like a primary and the base as a secondary object, whereas in others applied objects that are associated with most semantic roles may behave like secondary objects. Tigrinya makes a morphological distinction between directly and incidentally affected objects marking them with OM_1 and OM_2 , respectively. Applied objects that are associated with OM_1 exhibit the properties of primary objects, whereas applied objects marked with OM_2 exhibit the properties of secondary objects. However, in intransitive clauses the suffix OM_1 can also mark maleficiaries or ethically affected objects which display secondary object property.

There seems to be no cross-linguistic basis for the restrictions that languages tend to impose on the admission of the applicative morpheme based on the transitivity properties of a verb. Tigrinya admits applicative formations out of ditransitive, transitive and intransitive verbs - both unaccusative and unergative. Intransitive verbs may not admit an applicative morpheme for certain types of semantic role readings. For example, unergative verbs such as 'dance', 'swim' or 'scream' that do not entail a directional motion or transfer of emitted force or substance cannot bear the OM_1 suffix as they cannot code a goal applied object.

CHAPTER 6

Applicative vs. oblique coding

6.1 Introduction

As Donohue (2001:217) notes, some languages have a dynamic applicative system where there exists a productive parallelism between expressing a participant in an applicative or an oblique (PP) phrase. There are also languages that have a non-dynamic applicative system where the applicative expression is a basic grammatical means to express certain arguments. Thus, the applicative expressions of these arguments do not have oblique counterparts. For example, Bresnan and Moshi (1993:50) point out that in Kichaga, a Bantu language, there are no prepositions or case markers to mark beneficiary, maleficiary, instrumental and locative semantic roles. They also state that Chicheŵa lacks prepositions for the oblique coding of beneficiary and locative semantic roles. In Bajau, an Austronesian language, there are no prepositions for the oblique marking of beneficiary, locative and instrumental semantic roles (Donohue 1996:788). The investigation of such alternative strategies is of particular interest to studies of applicative constructions, especially for syntactic theories which describe applicative constructions as structural derivatives of oblique phrases (Marantz 1984, Baker 1988a). A syntactic theory such as LFG, however, does not support the derivational analysis of applicative constructions based on the fact that certain applied arguments do not have oblique counterparts (Alsina and Mchombo 1990, Bresnan and Moshi 1990, Bresnan 1994, Mchombo 1997). Some studies have also attempted to explain the pragmatic and discourse

reasons behind an applicative or an oblique coding of semantic arguments (Donohue 2001). In this chapter we aim to investigate prepositional case markers with respect to the semantic roles that they code and the possibility of expressing semantic roles in oblique phrases and applicative constructions, and to compare the two types of expression in terms of the discourse construal they mark.

6.2 Oblique vs. adjunct distinction

Semantic roles that are marked by prepositional case can have an oblique argument or an adjunct function. The terms ‘oblique’, ‘argument’ and ‘adjunct’ require some clarification since these terms are employed differently in the literature. Andrews (1985:89) uses the term oblique as a cover term for any prepositional phrase (PP). According to him, the oblique function comprises complements and adjuncts. A complement is a grammatical function that is required or governed by a predicator, for example, a verb. Van Valin (2001:24; 92-96) distinguishes between arguments and adjuncts which corresponds to the distinction between complements and adjuncts made by Andrews (1985). Bierwisch (2003:113) identifies arguments and modifiers as the semantic aspects of constituents, whereas complement and adjunct are their syntactic counterparts. However, Koenig et al. (2003:68) pair these terms differently. They consider arguments and adjuncts to relate to semantic dependents, whereas complements and modifiers to relate to syntactic dependents. In LFG, the term oblique is restricted to subcategorizable prepositional phrases, and is used to designate their grammatical function, whereas the term adjunct is used as a functional designation for non-subcategorizable PPs and adverbial expressions. Thus, adjuncts are classified as modifiers (Bresnan 2001:96, Dalrymple 2001:10).

Even though linguists agree on the existence of oblique vs. adjunct classes, there is no consensus among them concerning the manner in which these should be distinguished. Traditionally, criteria such as optionality/obligatoriness and selectedness are regarded as relevant grounds for this distinction (Bierwisch 2003, Koenig et al. 2003). In this sense, arguments are obligatory, and are selected by the verb, whereas adjuncts are optional. Dowty (1982) proposes an entailment test and a subcategorization test, which to some extent correlate with the optionality/obligatoriness and selectedness notions. However, as Dalrymple et al. (1995:9) note, even though these address important properties that distinguish between arguments and adjuncts, they cannot successfully discriminate between them. The limitation of such criteria is particularly reflected in the controversy regarding the argument status of seman-

tic roles which sometimes are referred to as participatory or circumstantial, such as beneficiary, instrumental and comitative. Usually these semantic roles are optional, but they are assumed to be obligatory when they are overtly realized in a clause. In example (157) we present the controversy in determining the argument status of instrumental semantic roles.

- (157) a. The boy broke the window (with a rock). (Van Valin 2001:94)
 b. The girl ate the pasta (with a fork). (Van Valin 2001:94)
 c. The policeman poked the body (with a stick). (Koenig et al. 2003:81)
 d. The policeman sipped his iced tea (with a straw). (Koenig et al. 2003:81)

Van Valin regards the instrumental PP phrase in (157a) as an argument since it can function as a subject argument (or an actor), as in ‘The rock broke the window’, and regards the instrumental PP in (157b) as an adjunct since it cannot function as a subject argument, as in **The fork ate the pasta*. In contrast, Koenig et al. analyze both the instrumental PPs in (157c) and in (157d) as arguments. According to them, even though the presence of an instrumental participant is necessary in the event described by *poke*, it can be syntactically optional. The verb *sip* does not entail the presence of an instrument, but when an instrument is overtly specified, it plays the same participant role as in (157c). Koenig et al. conclude that even though the instrument is not entailed by certain verbs such as *sip* it is logically necessary in the event specified by the verb. We agree with Koenig et al. that the argumenthood of instrumentals cannot be established simply by judging whether or not they are obligatory. However, if an instrument is explicitly specified in an event, then it plays a participant role, and thus functions as an argument.

Therefore, we suggest that arguments and adjuncts be distinguished on the basis of the specific role they play in an event. In LFG, this has been the guideline for differentiating oblique arguments from adjuncts. Oblique arguments are associated with specific roles such as recipient, beneficiary, goal, source, locative, instrumental, cause, reason, manner, etc. (Bresnan 1982a:292, Dalrymple 2001:26). Adjuncts are different from arguments since the information they add is related to the whole predication rather than to a specific participant (Bresnan 2001, Dalrymple et al. 1995, Butt et al. 1999, Kroeger 2004). For example, adjuncts may express concept of event location (as opposed to participant location), event time, manner, etc, as example (158) illustrates.

- (158) a. ኣብ ክሽነ (ኮይና) መጽሓፍ ኣንቢባ።
 ?ab kišinä (koyi-na) mäšihaf ?anbib-a
 Loc kitchen (PerfS.be-SM.3FSg) book PerfS.read-SM.3FSg
 ‘She read a book (while) in the kitchen./ Lit. She read a book (being) in a kitchen.’¹
- b. ትማሊ ኣብ መርግ ርእየያ።
 timali ?ab märʿa riʔy-ä-ya
 yesterday Loc wedding PerfS.see-SM.1Sg-OM₁.3FSg
 ‘I saw her in a wedding yesterday.’
- c. ብቕልጡፍ መጸኢ።
 bi-qäiltuf mäšiʔ-a
 Instr-quick PerfS.come-SM.3FSg
 ‘She came quickly.’

The location in (158a) is identified as an event location since it is the location where the reading event happens. Similarly, in (158b) neither the adverbial nominal *timali* ‘yesterday’ nor the event name *märʿa* ‘wedding’ denotes specific participants. The adverb *bi-qäilt* ‘quick’ in (158c), which is derived from the adjective *qäilt* ‘quick’ through the instrumental marker *bi-*, describes the manner in which the ‘coming’ event is performed.

Within research on applicative constructions, the oblique vs. adjunct distinction is considered as an important parameter for two reasons. Firstly, even though applied objects are regarded as core arguments independent of their semantic category, owing to the argument/adjunct distinction of their semantic roles applied objects may display different syntactic properties. Secondly, the oblique/adjunct distinction is considered significant since languages tend to set restrictions on admitting semantic roles to applicative constructions at different levels along the argument-adjunct continuum. A certain language may express peripheral/adjunct roles applicatively in a way that can be impossible in another language. For example, Peterson (2007:20) points out that the applicative expression of the prioritive semantic role is unique to Hakha Lai, as in (159).

- (159) a. kay-maʔ hlaan=?aʔ?a-kal
 1S-PRON before/front=Loc 3sS-go
 ‘He went ahead of me.’
- b. ?a-ka-kal-kaʔn
 3sS-1sO-go-PRIOR
 ‘He went ahead of me.’

¹In Tigrinya a PP expression of an event location can be modified by the use of a light verb such as *koyi-na* ‘she being/staying’; however a participant location cannot be modified by a light verb. This can be used as a diagnosis to distinguish argument PPs from adjuncts.

- c. ʔa-ka-thiʔ-kaʔn
 3sS-1sO-die₂-PRIOR
 ‘He died before me.’

In (159a) the prioritive semantic role which expresses temporal and spatial concepts is expressed as a PP, whereas in (159b) and (159c) it is expressed as an applied argument. The same temporal concept cannot be expressed applicatively in Tigrinya, as is shown in (160).

- (160) a. ቅድሚኡ ማይት ።
 qidmi-ʔa mäyit-u
 before-3FSg PerfS.die-SM.3MSg
 ‘He died before her.’
- b. ማይት/ላ ።
 mäyit-u-wa/la
 PerfS.die-SM.3MSg-OM₁/OM₂.3MSg
 ‘He died on/for her.’

In (160a) the preposition *qidmi* which can be translated as ‘in front of, before, ahead of’ bears a pronominal suffix for the pro-dropped object.² Thus, it can be considered as a pronominalized PP that expresses a temporal relation. As example (160b) shows, the temporal relation cannot be expressed applicatively. The applicative can only express a maleficiary and a beneficiary applied object readings. Tigrinya can express the same temporal concept as in the Hakha Lai example (159) through a serial verb construction, as in (161).

- (161) a. ቀዳሙዋ ማይት ።
 qädim-u-wa mäyit-u
 PerfS.precede-SM.3MSg-OM₁.3FSg PerfS.die-SM.3MSg
 ‘He died before her./ Lit. He, preceding her, died.’
- b. ቀዳሙዋ ከደዱ ።
 qädim-u-wa käyid-u
 PerfS.precede-SM.3MSg-OM₁.3FSg PerfS.go-SM.3MSg
 ‘He went ahead of/ before her./ Lit. He, preceding her, went.’

A serial verb construction such as in (161) consists of juxtaposed verbs without any coordination or subordination elements. The verbs in the final position (e.g. *mäyit-u* in (161a) and *käyid-u* and in (161b)) function as the main verb, and the verb preceding the main verbs (e.g. *qädim-u-wa*) functions as a modifier by supplying the

²In Tigrinya the object of a preposition can be expressed by a pronominal suffix when the object NP is not overtly realized, as in ንኣኡ *niʔ-ʔu* ‘him, to/for him’, ኣብኡ *ʔab-ʔu* ‘in it, in there’, ካብኡ *kab-ʔu* ‘from him/it, from there’, and ምስኡ *mis-ʔu* ‘with him/it’. The glottal stop ʔ serves to demarcate the syllabic boundary.

temporal notion. In this study we do not intend to describe serial verb constructions further.

In the following section we seek to investigate the dynamism between prepositional and applicative expressions in Tigrinya. Prepositional expressions will be investigated with respect to the type of semantic roles they code. We will also investigate the possibility of coding semantic roles in an applicative and oblique expression, and the pragmatic and discourse reasons behind the choice of these alternatives.

6.3 Prepositional vs. applicative coding in Tigrinya

Tigrinya employs prepositions to code a wide range of semantic roles. The following prepositional markers are identified in the language (162):³

(162) *ni-* dative, abstract direction, objective

miʔinti beneficiary, purpose, reason

silä beneficiary, purpose, reason

ʔab location

nab goal (allative)

kab source (ablative)

bi- instrument

bi-zaʕba topic/comment

mis comitative

³The allative or goal preposition *nab* is formed out of the dative *ni* and the locative *ʔab*, while the source preposition *kab* is formed out of the Ge'ez source preposition *kä* and the locative *ʔab*. The prepositions that consist of only one syllograph (i.e. a single symbol/graph in a syllabic writing system which consists of consonant and vowel phonemes) *ni-* and *bi-*, attach directly to specifiers and modifiers, as in *näti* (*ni-ʔiti*) 'to.the-3MSg' and *näta* (*ni-ʔita*) 'to.the-3FSg', *ni-kul-om* 'to.all-3MPI', *ni-ḥad-ä* 'to.one-MSg' and *ni-ṣibuq* 'for/to-good/beautiful'. They also attach directly to nouns, as in *ni-Saba* 'for/to-Saba' and *bi-naʕiṣo* 'by/through-door'. On the other hand, prepositions that consist of more than one syllograph, *ʔab*, *nab*, *kab*, *mis* and *bi-zaʕba*, are realized as independent words when they occur with nouns, as in *ʔab ṭawla* 'on table' and *mis Saba* 'with Saba', but can be realized either as assimilated or contracted forms with determiners and specifiers, as in *ʔabt-i* or *ʔab -ʔit* 'on/at/in-Det.3MSg', which can be interpreted as 'there'. Prepositions can also bear pronominal suffixes for a non-overtly realized object of a preposition, as in *ʔab-u* 'on/at/in-3MSg, there' and *mis-u* 'with-3MSg', *bi-zaʕba-u* 'about-3MSg, about him/it/that'.

Most of these prepositions are polysemous. They can have extended meanings that are related to the prototypical relation they mark. For example, *bi-* is a prototypical preposition for coding an instrument semantic role, but it also has extended meanings, for instance, to code metaphorical instruments such as cause and manner semantic roles. Each of these prepositions will be described with respect to the semantic roles they code, and the prepositional expression they code will also be contrasted with applicative expressions that convey the same semantic argument.

6.3.1 Directional *ni*

The preposition *ni* is a polysemous marker which semantically denotes abstract direction within the range of semantic relations which it codes. It is a prototypical dative preposition for the oblique expression of recipient and beneficiary semantic roles (163a).⁴ It also marks definite core objects (base and applicative) (163b), oblique expressions of direction (goal) arguments (163c) and temporal adjunct phrases (163d). Since the range of functions marked by *ni* is subsumed under the directional meaning, we will gloss this preposition as *DIR*. However, we will continue our glossing convention *Obj* to identify the objective case.

(163) a. Recipient/beneficiary

እቲ ሰብኣይ ንኹሉ ንገዘቡ ንዘኸገገጎት
 ?it-i säb?ay ni-kul-u gänzäb-u ni-zäktam-at
 Det-3MSg man Obj-all money-Poss.3MSg DIR-orphan-Pl
 ወፍደዎ ።
 wäfiy-u-wo
 PerfS.donate-SM.3MSg-OM₁.3MSg
 ‘The man donated all his money to orphans.’

b. Core object

እቲ ሰብኣይ ነታ ባናና በሊዑዋ ።
 ?it-i säb?ay n-ät-a banana bälif-u-wa
 Det-3MSg man Obj-Det-3FSg banana PerfS.eat-SM.3MSg-OM₁.3FSg
 ‘The man ate the banana.’

c. Direction

ንኡርትራ ከይዱ ኣሎ ።
 ni-?ertira käyid-u ?al-o
 DIR-Eritrea PerfS.go-SM.3MSg Pres.be-SM-3MSg
 ‘He has gone to Eritrea.’

⁴As described by Blansitt (1988:186) in a footnote, a prototypical dative relation is semantically characterized as “a voluntary transfer, not specifically involving exchange, intermediary, or motion”. For instance, the recipient of the verb *give* is marked by a prototypical dative case.

d. *Temporal adjunct*

ንሰለስተ መዓልታት መጸኢ ነይሩ ።
 ni-sälästä mäʕalt-at mäsiʔ-u näyr-u
 DIR-three day-Pl PerfS.come-SM.3MSg Past.be-SM.3MSg
 ‘He had come for three days.’

In (163a), *nī* marks the oblique expression of a recipient/beneficiary argument, *nī-dīka-tat* ‘to orphans’. In (163a) and in (163b), *nī* functions as an objective case marker. It is prefixed on the determiner *n-ät-a* (assimilated form of *nī-ʔita*) and the quantifier *nī-kul-u*, and the definite objects, *n-ät-a banana* ‘the banana’ and *nī-kul-u gänzäb-u* ‘all his money’, are indexed on the verb through object suffixes. In (163c) *nī-* marks an oblique expression of a goal (locative) semantic role *nī-ʔertira* ‘to Eritrea’. In (163d), *nī* codes a temporal adjunct expression, *nī-sälästä mäʕalt-at* ‘for three days’. Oblique and adjunct expressions cannot be indexed on the verb through verbal suffixes.

An obliquely expressed beneficiary argument, as in (163a), can also be expressed applicatively (164). The applied object is portrayed by a definite referent *nī-ʔom dīka-tat* ‘the orphans’, and the verb bears an object suffix for this argument.

(164) እቲ ሰብኣይ ነቶም ዘኸታማት ኩሉ ገንዘብ
 ʔit-i säbʔay n-ät-om zäktam-at kul-u gänzäb-u
 Det-3MSg man Obj-Det-3MPI orphan-Pl all money-Poss.3MSg
 ወፍዱሎም ።
 ʔawäfiy-u-lom
 PerfS.donate-SM.3MSg-OM₂.3MPI
 ‘The man donated all his money to the orphans.’

In general, the applied object cannot be associated with indefinite, non-specific, non-distinct and non-referential arguments. A referent of an applied object is individuated through an obligatory definiteness or specificity feature in Tigrinya. Individuation bestows on the participants discourse worthiness in order to emerge as applied objects, that is, as the most topical object functions in the discourse event. Since recipient and beneficiary arguments correspond to inherently sentient and human referents, and are considered as highly prominent in the discourse event in comparison to referents of a base object that co-occurs with them, they are commonly cast as applied objects.

A distinctness semantic requirement is stipulated in coding a goal argument applicatively. A locative noun that denotes a vast, indistinct or non-discrete location cannot appear as a goal applied object. Thus, the goal locational argument in (163c) cannot be coded applicatively, as in (165).

- (165) *ንኢርትራ/ነታ ሰበይቲ ክይዱዋ
 ni-ʔertira/n-ät-a säbäyti käyid-u-wa
 *Obj-Eritrea/Obj-Det-3FSg woman PerfS.go-SM.3MSg-OM₁.3FSg
 ኣሎ ።
 ʔal-o
 Pres.be-SM-3MSg
 ‘He has gone to *Eritrea/the woman.’

Since the referent of the locative argument ʔertira ‘Eritrea’ is not a discrete and restricted point of reference, it cannot constitute a convenient filler for the applied object argument with verbs that denote telic or punctual activities such as arriving or going. A goal argument can be coded as an applied object only if it has a semantic disposition to be affected by the action of an agent. An agent can affect a locative argument that has a concrete, distinct and restricted referent by engaging in a punctual and telic activity such as arriving at and/or going to a location. A concrete and distinct goal referent such as *n-ät-a säbäyti* ‘the woman’ can be coded applicatively, since it is an animate, definite and distinct referent thus and can be affected by the actions of the agent argument in the event of going. In contrast, with a location argument that has a vast area a referent can be coded as an applied object with verbs denote duration and spread such as invading, occupying, filling etc.

Similarly, the adjunct temporal concept in (163d) cannot be expressed applicatively (166). Since a temporal adjunct does not denote a distinct or specific participant or argument, it cannot be coded applicatively.

- (166) *ነተን ሰለስተ መዓልታት መጸኢ-ለን
 n-ät-än sälästä mäʔalt-at mäšiʔ-u-wä/län
 Obj-Det-3FPI three day-Pl PerfS.come-SM.3MSg-OM₂.3FPI
 ነይሩ ።
 näyir-u
 Past.be-SM.3MSg
 ‘He had come for the three days.’

6.3.2 Beneficiary *nä*, *mäʔinti* and *silä*

The prepositions *nä*, *mäʔinti* and *silä* ‘for’, ‘for the sake of’ or ‘on behalf of’ mark an oblique expression of a beneficiary or purpose/reason role. The preposition *nä* is more frequent and productive in marking a beneficiary than the other two, and it specifies an intended possessor beneficiary, while *mäʔinti* and *silä* are prototypical purpose/reason prepositions and also relate to an ethical/emotional beneficiary. The beneficiary and purpose/reason expressions are rendered more precise through serialization with the light verb *bähalä*, which literally means ‘he said’. In this context

the verb *?il-a*, a simple perfective form, is interpreted as ‘she intended, devoted, dedicated’, and functions as a subordinating serial verb. The light verb supplies the notion of ‘goodwill or good intention’ to the prepositional expressions, as is illustrated in (167).

- (167) a. ሳባ ነቲ መጽሐፍ ንዮናስ (ኢላ)
 Saba n-ät-i mäsiḥaf ni-Yonas (?il-a)
 Saba Obj-Det-3MSg book Dir-Yonas (PerfS.say-SM.3FSg)
 ገዘአቶ #
 gäzi?-a-to
 PerfS.buy-SM.3FSg-OM₁.3MSg
 ‘She bought the book (as she intended) for Yonas.’
- b. ሳባ ነቲ መጽሐፍ ምእንቲ ዮናስ (ኢላ)
 Saba n-ät-i mäsiḥaf mi?inti Yonas (?il-a)
 Saba Obj-Det-3MSg book BEN Yonas (PerfS.say-SM.3FSg)
 ገዘአቶ #
 gäzi?-a-to
 PerfS.buy-SM.3FSg-OM₁.3MSg
 ‘She bought the book (as she intended) for/on behalf of Yonas.’
- c. ሳባ ነቲ መጽሐፍ ስለ ዮናስ (ኢላ)
 Saba n-ät-i mäsiḥaf silä Yonas (?il-a)
 Saba Obj-Det-3MSg book BEN Yonas (PerfS.say-SM.3FSg)
 ገዘአቶ #
 gäzi?-a-to
 PerfS.buy-SM.3FSg-OM₁.3MSg
 ‘She bought the book (as she intended) for/on behalf of Yonas.’

As example (167a) shows, since the verb meaning *buy* allows the theme object to be redirected to another participant, then *ni* can code a beneficiary possessor argument, and it gives the reading that Yonas is going to have/possess the book. With *mi?inti* in (167b) and *silä* in (167c) the notion of an ethical beneficiary is more prominent than a possessor beneficiary. In this sense, Yonas is perceived as a beneficiary; either Saba buys the book on behalf of him, i.e. she does the buying which he was supposed to do, or she buys the book since she knows it pleases him.

On the other hand, the prepositions *mi?inti* and *silä* are more often used than *ni* with verbs that do not allow the intended possessor reading, as is illustrated in (168).

- (168) a. **ሳባ ነቲ መጽሓፍ ምእንቲ/ስለ/?ን-ዮናስ (ኢላ)**
 Saba n-ät-i mäsiḥaf mi?inti/silä/?ni-Yonas (?il-a)
 Saba Obj-Det-3MSg book BEN/BEN/?Dir-Yonas (PerfS.say-SM.3FSg)
ተሰኪማቶ ።
 täsäkim-a-to
 PerfS.carry-SM.3FSg-OM₁.3MSg
 ‘Saba carried the book for/on behalf of Yonas.’
- b. **ሳባ ምእንቲ/ስለ/?ን-ዮናስ (ኢላ) ብዙሕ**
 Saba mi?inti/silä/?ni-Yonas (?il-a) bizuḥ
 Saba BEN/BEN/?Dir-Yonas (PerfS.say-SM.3FSg) a-lot
ደኺማ ።
 däkim-a
 PerfS.be.tired-SM.3FSg
 ‘Saba got tired/toiled a lot for/on behalf of Yonas.’
- c. **ብዙሓት ጄጋኑ ስለ/ምእንቲ/?ን-ኢርትራ (ኢሎም)**
 bizuḥat ḡäganu silä/mi?inti/?ni-?ertira (?il-a)
 Many heroes BEN/BEN/?Dir-Eritrea (PerfS.say-SM.3MPI)
ሞይቶም ።
 moyt-om
 PerfS.die-SM.3MPI
 ‘The heroes died for/on behalf of Eritrea.’

Since the verb in (168a) does not allow the referent of the theme object to be redirected to another participant, *ni* cannot express a possessor beneficiary reading, but can give a marginally acceptable ethical beneficiary reading. When *ni* attaches to definite noun phrases, it acts more like a case marker than a preposition. Since both *Yonas* and *Eritrea* are definite nouns, *ni* can be interpreted as a case marker, but since the verb does not carry a verbal suffix for this object, the case marker reading is not possible. The competition between the case and prepositional readings makes *ni* less acceptable as an oblique marker with definite nouns. It is more accepted as a prepositional marker when it is used together with the subordinating serial verb *?il-a*. On the other hand, *mi?inti* and *silä* can express an ethically affected or a beneficiary argument with these verbs. Similarly, the stative verb *däkim-a* ‘she got tired’ (168b) and the intransitive verb *moyt-om* ‘they died’ (168c) cannot entail transfer of possession, thus the prepositions can only express ethical beneficiaries.

There is no one-to-one correspondence between the applicative and the oblique expression of the beneficiary argument on either the semantic or discourse levels. In the first place, the oblique expression has an unequivocal beneficiary reading, whereas the applicative expression is polysemous, as is illustrated in (169).

- (169) a. ሳባ ንወዳ መጻሕፍቲ ገዘአትሉ ።
 Saba ni-wäd-a mäših-ti gäzi?-a-tlu
 Saba Obj-boy-Poss.3FSg book.Pl PerfS.buy-SM.3FSg-OM₂.3MSg
 ‘Saba bought books for/from her son.’
- b. ሳባ ንሰብአያ እንጀራ በሊዓትሉ ።
 Saba ni-säb?ay-a ?inǰära bäli?-a-tlu
 Saba Obj-man-Poss.3MSg bread PerfS.eat-SM.3FSg-OM₂.3MSg
 ‘Saba ate bread for/on her husband.’
- c. ብዙሓት ጅጋት ንኤርትራ ሞይቶም-ላ/ዋ ።
 bizuḥat ḡäganu ni-?ertira moyt-om-la/wa
 Many hero.Pl Obj-Eritrea PerfS.die-SM.3MPI-OM₂/OM₁.3FSg
 ‘The heroes died for/on Eritrea.’

With transitive predicates the applied object can have a beneficiary, maleficiary, locative, goal, path or source semantic role reading, depending on the meaning of the verb used. For example, the applicative expression in (169a) yields beneficiary and source readings, and in (169b) beneficiary and maleficiary readings. With intransitive verbs, since different suffixes are employed to code beneficiary and maleficiary/affected arguments, there is no ambiguity between these readings, as in (169c). Further, given a suitable context that enhances the beneficiary reading, the applicative expression is more expressive and determined than the oblique expression. As we have discussed earlier, the oblique expressions with the beneficiary argument are somewhat coarse. In fact, they are rendered more focused through serialization of a light verb. In addition, as with all applicative expressions, the beneficiary applied object is highly topical. Since the beneficiary argument coincides with animate and human referents which render the beneficiary argument worthy of discourse topicalization, it frequently emerges in the applicative coding. Moreover, the applicative expression codes a maleficiary argument which cannot be expressed obliquely, as Tigrinya lacks a preposition for the oblique coding of this semantic role.

6.3.3 Purpose/reason *ni*, *mi?inti* and *silä*

The purpose/reason semantic role is marked with the same prepositions, *ni*, *mi?inti* and *silä*, as the beneficiary argument. The directional preposition *ni* is more productive in coding a reason semantic role in main clauses than *mi?inti* and *silä*. As Luraghi (2003:45), remarks the notions of purpose and reason are difficult to distinguish. She defines purpose as “an entity, often a state of affairs, aimed at by the intentional action of an agent”, and she states that “the reason that motivates

an agent to act is cognitively equivalent to the purpose of the action.” Thus, reason is perceived as the state of affairs that motivates an agent to act. Further, their coding and meaning tend to overlap cross-linguistically. As Luraghi (2003) points out “direction expression can be re-interpreted as denoting purpose, on account of a metaphorical equation of human intention with directional motion.” The debate regarding the semantic role overlap between beneficiary and purpose arguments in Chicheŵa pertains to this ambiguity (Alsina and Mchombo 1990:501).

- (170) a. Yêsu a-ná-f-ér-a anathu ôñse.
 1-Jesus 1S-PST-die-APPL-FV 2-people 1-all
 ‘Jesus died for all people.’
- b. Mtolankhâni a-na-thámáng-ir-á chíphadzûwa.
 1-journalist 1S-PST-run-AP-FV 7-beauty-queen
 ‘The journalist ran for the beauty queen.’

Baker (1988b:21) argues that the applied objects in (170) have reason/motive readings to substantiate his hypothesis that intransitive verbs do not allow a beneficiary applied object reading in Chicheŵa. Alsina and Mchombo (1990:501) oppose such analyses, and argue that these examples unequivocally mark a beneficiary applied object.

Beneficiary, goal and purpose arguments can be distinguished by the semantic properties of their referents. Beneficiary and goal arguments are associated with distinct and concrete referents, whereas purpose/reason arguments to a greater extent correspond to abstract entities that denote events or states of affairs. According to Hegarty (2003:892) “[...] a reason is a reason for a particular event or state in the world, or it is a purpose of an agent, or it has a connection to the world, but it is otherwise propositional in character, and is not a spatiotemporally delineated part of the world”. In contrast, he states that “Everyday concrete objects have high world immanence since they have spatiotemporal boundaries and interact causally with other objects”. Owing to such semantic properties a reason-denoting expression is typically coded as an adjunct subordinate clause, and cannot be selected by a predicate.

In Tigrinya beneficiary and goal arguments are amenable to applicative coding, whereas purpose/reason roles are not. The examples in (171) illustrate obliquely coded purpose semantic roles.

- (171) a. ዮናስ ምእንቲ/ነ-ገንዘብ ኢዩ ዝሰርሕ ።
 Yonas mi?inti/ni-gänzäb ?iy-u zi-säriḥ
 Yonas BEN/Dir-money Pres.be-SM.3MSg Rel.Imperf.3-work.SM.MSg
 ‘Yonas works for money.’

- b. እቲ ተመሃራይ ንመርመራ የጽኑዕ
 ?it-i tāmāharay ni-mārmāra y-äṣiniŋ
 Det-3MSg student Dir-exam Imprf.3-study-SM.MSg
 ኣሎ ።
 ?all-o
 Pres.exist.SM.3MSg
 ‘The student is studying for an exam.’
- c. እቲ ሓኪም ነታ ሰበይቲ ንመርመራ ደም
 ?it-i ḥakim n-ät-a säbäyti ni-mārmāra dām
 Det-3MSg doctor Obj-Det-3FSg woman Dir-test blood
 ልኢኹዋ ።
 li?ik-u-wa
 PerfS.send-SM.3MSg-OM₁.3FSg
 ‘The doctor sent the woman for a blood test.’
- d. (ን)ዕረፍቲ ከይዱ ።
 ni-ŋiräfti käyd-u
 DR-vacation PerfS.go-SM.3MSg
 ‘He went for/on a vacation.’
- e. ንኣኼባ ይዳለው ኣሎ ።
 ni-?akeba yi-dalāw ?all-o
 PURP-meeting Imprf.3-prepare.SM.MSg Pres.exist-SM.3MSg
 ‘He is preparing for/to a meeting.’
- f. (ን)መርዓ ንሉ ዓዲሙና ።
 ni-märfa g^wal-u ŋadim-u-na
 PURP-wedding girl-Poss.3MSg PerfS.invite-SM.3MSg-OM₁-1Pl
 ‘He invited us for his daughter’s wedding.’

In (171a) the reason semantic role reading is acquired from the implied meaning, i.e. the motivation of getting or acquiring money which causes the agent to engage in a certain state of affairs or activity, rather than the object money *per se*. Similarly, in the rest of the examples, exam (171b), blood test (171c), vacation (171d), meeting (171e) and wedding (171f) are perceived as reasons that motivate the agent to engage in the activities described by the verbs. In the oblique coding, an abstract goal semantic role reading may also be implied with verbs of motion such as *käydu* ‘he went’ (171d).

However, as we have already mentioned, since the states of affairs that fill the reason semantic role are commonly abstract and non-individuated entities, reason expressions are not amenable to applicative coding. As the following examples show, the applicative expression of a reason semantic role sounds peculiar, since the entities that function as applied objects are allotted undue discourse salience, and such high discourse salience is normally a characteristic of semantically concrete

and referential elements.

- (172) a. *ዮናስ ነቲ ገንዘብ ሸቲሉሉ ።
 Yonas n-ät-i gänzäb šäqil-u-lu
 Yonas Obj-Det-3MSg money PerfS.work-SM.3MSg-OM₂.3MSg
 ‘Yonas worked for the money.’
- b. *ነቲ መርመራ ደም ነታ ሰበይቲ
 n-ät-i märmära däṃ n-ät-a säbäyiti
 Obj-Det-3MSg test blood Obj-Det-3FSg woman
 ልኢኹሉ ።
 liʔik-u-lu
 PerfS.send-SM.3MSg-OM₁.3MSg
 ‘He sent the woman to a blood test.’
- c. *ነቲ መርዓ ዓሉ ንዓና
 n-ät-i märʕa g^wal-u ni-ʕa-na
 Obj-Det-3MSg wedding girl-Poss.3MSg Obj-PRO-1PI
 ዓዲሙሉ ኣሎ ።
 ʕadim-u-lu ʔall-o
 PerfS.invite-SM.3MSg-OM₂.3MSg Pres-exist-SM.3MSg
 ‘He has invited us for/to his daughter’s wedding.’

The applicative expressions of the semantic roles in (172) reflect inappropriate assignment of discourse salience for entities that do not have a semantic disposition to become individuated. In order for arguments to be coded as applied objects, they must be distinct from each other as well as the general background. Thus, entities that do not have this disposition cannot be coded as applied objects. This clearly reflects the discourse motivation of the applicative coding.

However, with verbs such as *tädaläwä* and *täqäräbä* ‘he became ready, he got prepared’ the goal of preparation is equivalent to a purpose by virtue of their meaning. In this sense, the purpose reading overlaps with that of an abstract goal argument, and this can be expressed applicatively, as in (173).

- (173) a. ነቲ ዋዕላ ይዳለዉሉ
 n-ät-i waʕla yi-daläw-u-lu
 Obj-Det-3MSg conference Imperf.3-prepare-SM.MPI-OM₂.3MSg
 ኣለዉ ።
 ʔallä-wu
 Pres-exist-SM.3MPI
 ‘They are preparing for the conference.’

- b. ነቲ መርዓ ተቐረቦምሉ
 n-ät-i märʿa tä-qärib-om-lu
 Obj-Det-3MSg wedding DT-PerfS.be=ready-SM.3MPI-OM₂.3MSg
አለዉ።
 ʔallä-wu
 Pres-exist-SM.3MPI
 ‘They have become ready for the wedding.’

The events meeting and wedding are perceived as goals to which the agent directs the preparatory activities, i.e. the agent is engaged in activities that he/she hopes will lead to the successful realization of these states of affairs.

6.3.4 Locative ʔab

The locative preposition ʔab ‘on’, ‘in’ or ‘at’ denotes a spatial concept without indicating a particular spatial relation with respect to the object’s location. Various spatial relations are complemented through relational words such as *liʿli* ‘top’, *tiḥli* ‘under’, *wiṣti* ‘inside’, *qidmi* ‘front’, *dihri* ‘behind’, *godni* ‘side’, *yäman* ‘right’, *ṣägam* ‘left’, etc. However, without these relational items, ʔab is interpreted by default as ‘on’ or ‘in’, depending on the meaning of the location noun it modifies, as in (174).

- (174) a. ዓላ አብ (ውሽጢ) ባሕሪ ይነብር።
 ʿasa ʔab (wiṣti) bahri yi-näbir.
 fish Loc (inside) sea Imperf.3-live.SM.MSG
 ‘Fish live in (the) sea.’
- b. ነታ መጽሐፍ አብ (ልዕሊ/ትሕቲ) ጣውላ
 n-ät-a mäṣiḥaf ʔab (liʿli/tiḥti) ṭawla
 Det-Det-3FSg book Loc (top/under) table
አንቢሩዋ።
 ʔambir-u-wa
 PerfS.place-SM.3MSG-OM₁.3FSg
 ‘He placed the book on (top of /under) a table.’
- c. እታ ነፋሪት አብ ልዕሊ እታ ከተማ ዘምቢያ።
 ʔit-a näfar-it ʔab liʿli ʔit-a kätäma zämbiy-a
 Det-3FSg airplane-F Loc over Det-3FSg city PerfS.hover-SM.3FSg
 ‘The airplane hovered over the city.’
- d. አብቲ ሓዲሽ ስራሕ ብዙሕ አድሂቡ
 ʔab-t-i ḥaddiš sirah bizuḥ ʔadhib-u
 Loc-Det-3MSG new.M work a-lot/many PerfS.focus-SM.3MSG
አሎ።
 ʔal-o
 Pers.exist-SM.3MSG
 ‘He has been focusing a lot on the new work.’

In (174a) the *?ab* without the relational items is interpreted as ‘in’ since it refers to the inner location *bahri* ‘sea’ to denote a habitat. The use of the relational item *wiṣṭi* ‘inside’ specifies this default meaning further. Similarly, in (174b) *?ab* is interpreted as ‘on’ without the relational items, since the top level surface of a ‘table’ is normally taken to be its default spatial relation. In contrast, in (174c) the locative marker cannot be used without the relational term *liṣli* ‘over’, since with this verb, the main spatial relation is not the default surface location. The locative preposition can also mark a metaphorical locative argument, as in (174d).

In Tigrinya, applicative coding differentiates between a location where one of the participants is located, and a location where the event as a whole takes place. A semantic role denoting a participant’s location can be expressed as an applied object, whereas a semantic role denoting a location of an event cannot occur as an applied object, as in (175).

- (175) a. ኣብ ዓራት መጽሓፍ ኣንቢሩ ።
 ?*ab* *ʕarat* *mäṣḥaf* *?anbir-u*
 Loc bed book PerfS.put-SM.3MSg
 ‘He put a book on a bed.’
- b. ነቲ ዓራት መጽሓፍ ኣንቢሩሉ ።
 n-ät-i *ʕarat* *mäṣḥaf* *?anbir-u-lu*
 Obj-Det-3MSg bed book PerfS.put-SM.3MSg-OM₂.3MSg
 ‘He put a book on the bed.’
- c. ኣብ ዓራት (ኮይኑ) መጽሓፍ ኣንቢቡ ።
 ?*ab* *ʕarat* (*koyin-u*) *mäṣḥaf* *?anbib-u*
 Loc bed (PerfS.be-SM.3MSg) book PerfS.read-SM.3MSg
 ‘He read a book (being) in bed.’
- d. *ነቲ ዓራት መጽሓፍ ኣንቢቡሉ ።
 n-ät-i *ʕarat* *mäṣḥaf* *?ambib-u-lu*
 Obj-Det-3MSg bed book PerfS.read-SM.3MSg-OM₂.3MSg
 ‘He read a book in bed.’

The locative argument in (175a) is inherently lexicalized in the meaning of the verb and its referent serves as the location of the referent of the theme object *mäṣḥaf* ‘book’. The same concept can be expressed using the applicative expression in (175b). Here the applied object has high discourse salience. The location of the event in (175c) is however not inherently lexicalized in the meaning of the verb. An event location becomes more specified by serialization with the light verb *koyin-u* ‘he being/ he staying’ which has a function similar to that of a gerundive phrase in English. The insertion of a serial verb serves as a diagnostic for argument and adjunct locative PPs in Tigrinya. Adjuncts allow an optional serialization with light

verbs, while arguments do not. The locative semantic roles in (175d) cannot be coded applicatively since *ʕarat* ‘bed’ is a location where the event of reading took place. But, had the locative referent been an animate entity, the construction could have been grammatical for a beneficiary reading.⁵ However, event locations that are applied to intransitive verbs can appear in applicative constructions, as in (176).

- (176) a. **ዮናስ ኣብታ ዓራት (*ኮይነ)** **ደቂቡ ።**
 Yonas ʔabʔt-a ʕarat (*koyin-u) däqis-u
 Yonas LocʔDet-3FSg bed (*PerfS.be-SM.3MSg) PerfS.sleep-SM.3MSg
 ‘Yonas slept (*being) on the bed.’
- b. **ዮናስ ነታ ዓራት ደቂቡ-ላ/ዎ ።**
 Yonas n-ät-a ʕarat däqis-u-wa/la
 Yonas Obj-Det-3FSg bed PerfS.sleep-SM.3MSg-OM₁/OM₂.3FSg
 ‘Yonas slept on the bed/Yonas slept the bed.’

The event in (176a) cannot be modified by the serial light verb *koyinu*, indicating the argument status of the locative participant. Thus, the locative argument can be expressed applicatively (176b). The referent of the applied locative argument is more salient than the referent of the obliquely expressed argument. Moreover, in the applicative it is possible to encode a topical locative argument perceived as a mere location with OM₂, and a locative argument that is perceived as an affected location with OM₁.

The applicative expression codes locative arguments that are salient and foregrounded in the discourse context. A generic statement of a habitual locative relation as in (174a) cannot be expressed in applicative constructions. In the following examples (177) the referent of the locative argument is the topic of discussion, thus it is coded as an applied object.

- (177) a. **ዮናስ ነታ ጽርይቲ ጣውላ መጽሓፍ ኣንቢሩላ ።**
 Yonas n-ät-a ʕiriy-ti ʕawla mäʕʕaf ʔambir-u-la
 Yonas Det-3FSg clean-F table book PerfS.place-SM.3MSg-OM₂.3FSg
 ‘Yonas placed a book on the clean table.’

⁵It seems that whether a locative semantic role can appear as applied object or not has to do also with clause types. In Tigrinya adjuncts that commonly do not appear in applicative expressions within a main clause can be expressed as applied objects in dependent clauses and modifying phrases such as relative clauses. This deserves research in its own right. We hope it will be investigated further in the future.

- b. አታ ነፋሪት ነታ ከተማ
 ?it-a nāfar-it nā-t-a kätäma
 Det-3FSg airplane-F Obj-Det-3FSg city
 ዘምቢያታ ።
 zämbiy-a-ta
 PerfS.hover-SM.3FSg-OM₁.3FSg
 ‘The airplane hovered over the city.’
- c. ዮናስ ነቲ ሕዲሽ ስራስ ብዙስ
 Yonas n-ät-i ḥaddiš sirah̄ bizuḥ̄
 Yonas Obj-Det-3MSg new.M job a-lot/many
 አድሂቡሉ አሎ ።
 ?adhib-u-lu ?al-o
 PerfS.focus-SM.3MSg-OM₂.3MSg Pres.exist-SM.3MSg
 ‘Yonas has been focusing a lot on the new job.’

As can be seen from the examples in (177) only definite locative arguments can be cast as applied objects. In (177a) the referent of the locative argument ‘table’ is more topical than the base object of the verb. The locative object controls pronominal marking and is moved in front of the indefinite theme object. The applicative expression in (177b) marks an affected locative object. The referent of the locative argument ‘city’ is perceived as being thoroughly scrutinized by the airplane; for example, in order to conduct a search or to spy on those in the city. The affected locative object reading in (177b) can only be gained through the applicative coding. The metaphorical location in (177c) is topical in the discourse, thus it becomes worthy of being coded as an applied object.

6.3.5 Allative *nab*

The preposition *nab* ‘to/towards’ canonically marks the oblique expression of a goal semantic role, as in (178a). A preposition or a case marker that denotes movement to a certain place is identified as an allative marker (Blansitt 1988:174). However, a goal semantic role can also be marked with the directional preposition or be realized as a bare nominal when it codes spatial referents such as *gäza* ‘house/home’, *timhirti* ‘school’, *riḥa* ‘river’, *ḥidaga* ‘market’, *kätäma* ‘city’ etc. that are associated with certain conventional activities (178b), and identifiable names of locations, as in (178c).

- (178) a. የኖስ ነታ ከዕሶ ን/ናብ መንደቅ
 Yonas n-ät-a k^wiso ni-/nab mändäq̄
 Yonas Obj-Det-3FSg ball Dir/ALL wall
ድርቢዮዎ ።
 därbiy-u-wa
 PerfS.throw-SM.3MSg-OM₁.3FSg
 ‘Yonas threw the ball gainst (the) wall.’
- b. የኖስ ንጎሉ (ን/ናብ) ቤት ትምህርቲ
 Yonas ni-g^wal-u (ni-/nab) bet timhirti
 Yonas Obj-girl-Poss.3MSg (Dir/ALL) house education
ሰዲዱዎ ።
 sädid-u-wa
 PerfS.send-SM.3MSg-OM₁-3FSg
 ‘Yonas sent his daughter to school.’
- c. የኖስ (ን/ናብ) ኦስሎ ከይዱ ።
 Yonas (ni-/nab) Oslo käyd-u
 Yonas (Dir/ALL) Oslo PerfS.go-SM.3MSg
 ‘Yonas went to Oslo.’

Both dative and allative prepositions can be used in all these examples (178). The prepositional markers are obligatory with generic location nouns such as *mändäq̄* ‘wall’. The definite theme object *k^wiso* ‘ball’ is case marked and also indexed on the verb. In (178b) and (178c) the goal argument can be marked either by the allative *nab* or the directional preposition *ni-*, or it can be coded as a bare noun. The allative and the directional expressions have slightly different meaning. For example, in (178b) the oblique expression with the directional preposition, *ni-bet timhirti* ‘to school’ implies that the girl is sent to the school where she pursues her studies, but the expression with the allative preposition implies that she is sent to an unspecified school. This is similar to the distinction ‘to school’ vs. ‘to the school’ in English.

The applicative expression codes goal arguments that are perceived as affected participants in an event. Commonly, goal arguments that are associated with referents that serve as endpoints for moving entities are found in applicative coding. Wider locational settings that serve as referents for goal arguments do not usually appear as applicative objects, as can be seen in example (179).

- (179) a. የኖስ ነቲ መንደቅ/ወዲ ከዕሶ
 Yonas n-ät-i mändäq̄/wäddi k^wu^oiso
 Yonas Obj-Det-3MSg wall/boy ball
ድርቢዮሉ ።
 därbiy-u-lu
 PerfS.throw-SM.3MSg-OM₂.3MSg
 ‘Yonas threw a ball to the wall./ Yonas threw a ball at/to a boy’

- b. ኑናስ ነታ ጎል/*ጎሎስሎ ከይዱዋ ።
 Yonas n-ät-a g^wal/*ni-Oslo käyd-u-wa
 Yonas Obj-Det-3FSg girl/*Obj-Oslo PerfS.go-SM.3MSg-OM₁.3FSg
 ‘Yonas went at the girl/*Oslo.’

In (179a) the applicatively coded goal object is perceived as an essential part of the discourse. Semantically, it also expresses an affectedness notion which cannot be attained from its oblique counterpart (178a). The oblique expression codes in a neutral way the fact that the referent of the goal argument is the endpoint towards which the theme object moves. In the applicative expression, however, the goal object is perceived as the intended target. The applied goal argument of a transitive verb is coded with OM₂ since it is an indirectly/incidentally affected object (179a). The agent affects the goal by moving towards it or throwing another entity to it. However, with intransitive verbs since the interaction involves only two participants, the moving entity and the goal, the moving entity is perceived as the principal medium that affects the goal object. Thus, it is coded as an implicated object with OM₁ (179b). Since the referent of a setting/location goal such as Oslo is unlikely to be affected by the moving entity, it cannot be coded as an applied object. In contrast, a goal argument with a clearly individuated referent that serves as an endpoint or a target can be coded as an applied object. Moreover, the sentient quality of an argument is also a relevant feature for its applicative coding. Since the referent of the goal argument *g^wal* ‘girl’ (179b) is both a distinct endpoint and a sentient entity, it qualifies for applicative coding.

6.3.6 Ablative *kab*

An oblique expression of a source semantic role is marked with the ablative preposition *kab* ‘from’. The term ablative designates a preposition or case marker that codes a location from which something is removed or moved away. Example (180) illustrates an oblique expression of a source/ablative semantic role.

- (180) ሳባ ካብቲ ጸሕሊ ጸብሐ ወሲዳ ።
 Saba kab-t-i ṣahli ṣäbhä wäsida
 Saba ABL-Det-3MSg pot stew PerfS.take-SM.3FSg
 ‘Saba took stew from the pot.’

The source argument may arise as a result of a directive meaning of verbs, for instance, *wäsädä* ‘take’, *wäṣä?ä* ‘exit/go out’, *fälfälä* ‘surge/flow’, *?amilätä* ‘escape’ or *mäs?ä* ‘come’. These verbs include in their meaning an intrinsic orientation of the motion they describe. The source argument can also occur with verbs that do not

inherently indicate motion or directionality, for instance, *täšākämä* ‘carry’ (181a) and ‘eat’ (181b). The ablative can also mark adverbial adjuncts of time. With time expressions it denotes a commencement of an action or state, as in (181c).

- (181) a. ሳባ ነቲ ዕንጨይቲ ካብ ሩባ ከሳብ ገዛ
 Saba n-ät-i ፕinčäyti kab ruba kisab gäza
 Saba Obj-Det-3MSg wood ABL river up-to house
 ተሰኪማቶ ።
 tä-säkim-a-to
 DT-Perf.carry-SM.3FSg-OM₁.3MSg
 ‘Saba carried the wood from the river up to the house.’
- b. ሳባ ካብቲ ጸብሒ በሊኖ ።
 Saba kab-t-i šäbiḥi bäliŷa
 Saba ABL-Det-3MSg stew PerfS.eat-SM.3FSg
 ‘Saba ate from the stew./ Saba ate some of the stew.’
- c. ዮናስ ካብ ትማሊ ጀሚሩ ኣብዚ
 Yonas kab timali ጃämmir-u ጎab-zi
 Yonas ABL yesterday PerfS.start-SM.3MSg Loc-Prox.3MSg
 ኣሎ ።
 ጎal-o
 Pres.be-SM.3MSg
 ‘Yonas has been here since yesterday.’

In (181a) the ablative preposition marks a source semantic role that corresponds to a location which is the starting point for the carrying event, and the preposition *kisab* ‘up to or until’ marks the endpoint of the distance covered. The source semantic role is not entailed by the verb’s meaning. Also in (181b) the ablative codes a source argument which is not entailed by the verb. In (181c) the ablative preposition codes a temporal adjunct expression. The ablative relation can also imply the existence of a location that something is moved to (i.e. a goal), as in (182).

- (182) ሳባ ነቲ ዕንጨይቲ ካብ ገዛ ንደገ
 Saba n-ät-i ፕinčäyti kab gäza ni-dägä
 Saba Obj-Det-3MSg wood ABL house Dir-outside
 ኣውጺኦቶ ።
 ጎa-wišiŷ-a-to
 Caus-exit-SM.3FSg-OM₁.3MSg
 ‘Saba took the wood out of the house.’

As with other semantic roles that we have already discussed, the applicative expression of a source semantic role is also related to the notions of affectedness and topicality. The notion of affectedness is partly implied by the meaning of verbs that denote events that may involve a source argument. Let us compare the follow-

ing verbs with regard to the meaning of the source semantic role that they can be associated with (183).

- (183) a. ሳባ ነቲ ጻሕሊ ጻብሐ ወሲ ዳትሉ ።
 Saba n-ät-i ṣahli ṣäbihi wäsida-tlu
 Saba Obj-Det-3MSg pot stew PerfS.take-SM.3FSg-OM₂.3MSg
 ‘Saba took stew from the pot.’
- b. ሳባ ነቲ ሽግር ብእዋኑ
 Saba n-ät-i šiggir bi-ʔiwan-u
 Saba Obj-Det-3MSg problem Instr-Time-3MSg
 ኣምሊጥትሉ ።
 ʔamliṭ-a-tlu
 PerfS.escape-SM.3FSg-OM₂.3MSg
 ‘Saba escaped from the problem in time.’
- c. ሳባ ነቲ ገዛ ብዙሕ ርስሓት/ኣቕሑት/ፊንጫይቲ
 Saba n-ät-i gäza bizuḥ riṣḥat/ʔaḳuḥut/ʔinčäyti
 Saba Obj-Det-3MSg house a-lot garbage/equipment/?wood
 ኣውጺኣትሉ ።
 ʔa-wišiʔ-a-tlu
 Caus-PerfS.exit-SM.3FSg-OM₂.3MSg
 ‘Saba withdrew/took out a lot of garbage/equipment/?wood from the house.’
- d. *ሳባ ነቲ ሩባ ፊንጫይቲ ክሳብ ገዛ
 Saba n-ät-i ruba ʔinčäyti kisab gäza
 Saba Obj-Det-3MSg river wood up-to house
 ተሰኪማትሉ ።
 täsäkim-a-tlu
 PerfS.carry-SM.3FSg-OM₂.3MSg
 ‘?Saba carried wood for the river up to the house.’

In these examples (183), the referent of the source argument is conceptualized as a container, an event or a building from which something moves out or is removed. The entity that is moved or removed is initially contained inside the referent of the source argument. The stew is contained in the pot (183a), Saba is found in the middle of the problem (183b), and the house contained the garbage or equipment (183c). The applicative expression of a source argument seems to fit when the items that are removed or moved away are perceived as conventional components of the referent of a source argument. Thus, a house can be perceived as a conventional location for garbage and equipment, since garbage can be produced daily inside the house, and equipment, which in the Tigrinya sense includes all items used in a household such as furniture and appliances, normally are found in the house. On the other hand, the intended referent of the source argument *ruba* ‘river’ in (183d) is not conceptualized as a location which contains the things that are carried away from

it. As the translation shows, it codes a beneficiary reading. It is the starting point of the distance that the wood is transported over. The verb *täsäkämä* ‘he carried’ itself does not entail the notion of a source argument. These kinds of adjunct notions cannot appear in an applicative coding. Similarly, the temporal adjunct in (181c) cannot be expressed applicatively. The reason that these semantic role concepts are not suitable in the applicative coding has to do with semantic requirements such as delimitation and distinctness that these entities lack.

Applicative coding makes a distinction between an incidentally affected and directly affected source applied object. Such a distinction cannot be expressed through oblique coding. In general, since the orientation of the motion involving source applied objects is ‘away’ from the referent of the source argument, the source is not conceptualized as implicated. With goal applied objects, on the other hand, since the orientation of the motion is ‘towards’ the referent of the goal argument, those that show a disposition to be affected by the moving entity can be coded as implicated/directly affected applied objects with OM_1 . Nonetheless, there are some verbs that code the source argument as an implicated participant when it coincides with an animate referent or is a source in the real sense of the word. For example, with the verb *täqäbälä* ‘he received’ the oblique expression is employed when the referent of the source argument is a location or is a distantly located human referent (184a), while the applicative coding is used when the source argument has a human referent that is capable of acting as a direct medium to make the message or item reach the recipient, as in (184b).

- (184) a. ሳባ ካብ ኣስመራ/ኣቦኣ መልእኽቲ ተቐቢላ ።
 Saba kab ?asmära/?abo?-a mäl?iḵti täqäbil-a
 Saba ABL Asmara/father-Poss.3FSg message/letter PerfS.receive-SM.3FSg
 ‘Saba received a letter/message from Asmara/her father.’
- b. ሳባ ነቦኣ/*ነስመራ መልእኽቲ
 Saba n-äbo?-a/*n-äsmära mäl?iḵti
 Saba Obj-father-Poss.3FSg/*Obj-Asmara message/letter
 ተቐቢላ-ቶ/ትሉ ።
 täqäbil-a-to/tlu
 PerfS.receive-SM.3FSg- OM_1/OM_2 .3MSg
 ‘Saba received a letter/message from her father/*Asmara./ Saba received a letter/message for/on behalf of her father/*Asmara.’

The obliquely expressed source argument in (184a) is perceived as the origin (location) or sender (human) of the item that is received. However, the referent of the applied object in (184b) is mainly interpreted as someone who directly delivers a message/letter either by communicating or handing it over to the recipient, and the

referent of the applied object may not necessarily be the source of the letter/message itself. That is why the non-human source referent ‘Asmara’ cannot function as a referent of an applied object. The applied object must be coded as an implicated object (OM₁) which signals the direct transfer of an item from the source to the recipient.

Another example of a verb that codes a source applied object as an implicated object is *qädiḥä* ‘draw/take out’. When the entity that is drawn out from the referent of the source argument is perceived as a component of the source, as blood to the body of a person (185a), and water to the well (185b), the applied object can also be coded as an affected object. But it cannot be coded as an affected object if the drawn entity is not conceptualized as a component of the referent of a source argument, as water in relation to a jar (185c).

- (185) a. **ኣቲ ኣኪም ነታ ሕምምቲ ደም**
 ?i-ti ḥakim n-ät-a ḥimim-ti däṃ
 Det-3MSg doctor Obj-Det-3FSg sick-FSg blood
ቅዳሒ-ዋ/ላ ።
qädiḥ-u-wa/la
 PerfS.draw-SM.3MSg-OM₁/OM₂.3FSg
 ‘The doctor drew blood from the (F) patient.’
- b. **ነታ ኄላ ብዙስ ማይ ቅዳሒ-ዋ/ላ ።**
 n-ät-a ሃላ bizuḥ may qädiḥ-u-wa/la
 Obj-Det-3FSg well a-lot-of water PerfS.draw-SM.3MSg-OM₁/OM₂.3FSg
 ‘He drew a lot of water from the well.’
- c. **ነታ ዕትሮ ብዙስ ማይ**
 n-ät-a ሃትሮ bizuḥ may
 Obj-Det-3FSg jar a-lot-of water
ቅዳሒ-ላ/*ዋ ።
*qädiḥ-u-la/*wa*
 PerfS.draw-SM.3MSg-OM₂/*OM₁.3FSg
 ‘He drew a lot of water from the jar.’

The non-affected source object reading (185) is comparable to an oblique coding of a source semantic role, except for the difference in its discourse function, i.e. the applicatively coded source argument is more topical than an obliquely coded argument. On the other hand, the affected source object reading in (185a) and (185b) can only be attained from the applicative expression.

Like applied objects that bear a beneficiary, goal or source semantic role, a source applied object is more prominent in the discourse context than an obliquely coded source argument.

6.3.7 Instrumental *bi*

The preposition *bi* ‘with, by’ serves to mark an oblique expression of an instrument (186a), a path (186b), an agent (186c), a cause (186d) or a reason (186e) semantic role. It also marks manner (186f) and temporal (186g) adjunct expressions.

(186) a. *Instrument*

ሳባ ነቲ ዕትሮ ብሳዕሪ ደቢአቶ ።
 Saba n-ät-i ʕitro bi-saʕri däbiʔ-a-to
 Saba Obj-Det-3MSg jar Instr-grass PerfS.seal-SM.3FSG-OM₁.3MSg

‘Saba sealed the jar with grass.’

b. *Path*

እቲ ሰራቂ ብማዕጾ ወጸኡ ።
 ʔi-i säraq-i bi-door wäsiʔ-u
 Det-3MSg thief-M Instr-door PerfS.exit-SM.3MSg

‘The thief exited/went out through the door.’

c. *Agent*

ብዙሓት እንስሳታት ብሃዳኖ ተቐቲሎም ።
 bizuḥat ʔinsisa-tat bi-hadano tä-qätil-om
 many animal-Pl Instr-hunters DT-PerfS.kill-SM.3MPI

‘Many animals have been killed by hunters.’

d. *Cause*

አብ አፍሪቃ ብዙሓት ቀልዑ ብዓሶ ይመውቱ ።
 ʔab ʔafriqa bizuḥat qolʕu bi-ʕaso yi-mäwwit-u
 Loc Africa many baby.Pl Instr-malaria Imperf.3-die-MPI

‘Many children die from malaria in Africa.’

e. *Reason*

ብቅንዕናኣ ፈትዩያ ።
 bi-qinʕina-ʔa fätiy-ä-ya
 Instr-honesty-Poss.3FSG PerfS.like-SM.1Sg-OM₁.3FSG

‘I liked her for her honesty.’

f. *Manner*

ዮናስ ብታህዋኸ ወጸኡ ።
 Yonas bi-tahwak wäsiʔ-u
 Yonas Instr-haste PerfS.exit-SM.3MSg

‘He exited/went out hastily.’

g. *Temporal*

ዮናስ ነቲ ስራሕ ብኸልተ ሰዓት
 Yonas n-ät-i srahî bi-kiltä siʿat
 Yonas Obj-Det-3MSg work Instr-two hour
ወዲኡዎ ።
 wädiʔ-u-wo
 PerfS.finish-SM.3MSg-OM₁.3MSg
 ‘Yonas finished the work within/in two hours.’

Marantz (1984:246) defines a typical instrumental argument as an “inanimate tool used by the actor in performing an action”. In this sense only an instrument that functions as a tool, as in (186a), belongs to the typical instrumental category. According to Gruber (1965) “the instrumental phrase cannot ordinarily be used without the subject being an agent”. This eliminates instances where an instrument is coded as a subject.

Instrumental semantic roles can be incorporated in the meaning of a verb, as in these examples: *däbiʔä* ‘he closed/sealed up’, *ʕabäsä* ‘he plugged/suffocated’, *hanäqä* ‘he strangled’, *šämädä* ‘he trapped’, etc. Such roles therefore function as oblique arguments when they are overtly realized in a clause. Instrumental arguments can also appear with verbs such as *bälʕä* ‘he ate’ and *šähafä* ‘he wrote’, where the instrumental argument is less central to the meaning of these verbs. As Koenig et al. (2003:81) remark, instrumental participants function as arguments regardless of whether they fulfill semantically obligatory or optional roles. This claim is supported by the applicative coding of the instrumental semantic role. Applicative constructions do not discriminate between instrumental semantic roles that are inherently lexicalized in the meaning of a verb and those which are added as event participants. Indeed, all such roles can be coded as applied objects, as in (187).

- (187) a. **ሳባ ነቲ ሳዕሪ ዕትሮ ደቢኣትሉ ።**
 Saba n-ät-i saʕri ʕitro däbiʔ-a-tlu
 Saba Obj-Det-3MSg grass jar PerfS.seal-SM.3FSg-OM₂.3MSg
 ‘Saba sealed the jar with grass.’
- b. **ሳባ ነቲ ክሻፋ ኣዕዋፍ ርእያትሉ ።**
 Saba n-ät-i kišafa ʔaʕwaf riʔy-a-ltu
 Saba Obj-Det-3MSg binoculars birds PerfS.see-SM.3FSg-OM₂.3MSg
 ‘Saba saw birds with the binoculars.’

The instrumental argument in (187a) is semantically required by the verb, whereas the instrumental argument in (187b) is not, but is nevertheless allowed by the event that the verb denotes. Both instrumental arguments are coded as applied

objects through the non-affected object suffix OM₂. The two types of instrumental roles are treated in the same way in applicative coding, which suggests that in both sentences the instrumental roles function as arguments.

Instrumental applied arguments, however, cannot be coded as affected objects. Since instrumental participants are conceptualized as intermediaries, they cannot be affected by the actions performed by the agent. In contrast, locative and goal applied arguments can be conceptualized as endpoints of a moving entity, and can therefore be coded as affected objects. For example, when a locative or a goal semantic role is applied to an intransitive verb, since the referent of the agent/theme argument acts directly upon the referent of the applied locative or goal argument, the applied object is coded as an affected object. With instrumental arguments such conceptualization is not possible, as shown in (188).

- (188) a. **እተን ዓባይ ሰበይቲ ቦቲ/ኣብቲ ሙርኩስ**
 ?it-än ?abay säbäyti b-ät-i/?ab-t-i mirkus
 Det-3FH elderly.F woman.Sg Instr-Det-3MSg/Loc-Det-3MSg stick.Sg
ደው ኢለን ኣለዋ ።
 däw ?il-än ?alä-wa
 stand PerfS.stay-SM.3FH Pres.exist-SM.3FH
 ‘The elderly woman has stood up with/on the stick.’
- b. **እተን ዓባይ ሰበይቲ ነቲ ምርኩስ ደው**
 ?it-än ?abay säbäyti n-ät-i mirkus däw
 Det-3FH elderly.F woman.Sg Obj-Det-3MSg stick.Sg stand
ኢለናሉ/ኦ ኣለዋ ።
 ?il-än-alu/?o ?alä-wa
 PerfS.stay-SM.3FH-OM₂/OM₁.3MSg Pres.exist-SM.3FH
 ‘The elderly woman has stood up with the stick./ The elderly woman has stood up on the stick.’

In (188a) the ‘stick’ can be coded as an instrumental or a locative oblique argument by using the relevant preposition, *b*_i for the instrumental and *?ab* for the locative. Both the instrumental and locative arguments can be coded applicatively (188b). The instrumental reading is gained only from OM₂, but the locative can be associated with both OM₁ and OM₂, coding an affected and non-affected applied object, respectively.

Moreover, non-human referents that denote tools and body parts can serve as fillers of instrumental arguments in oblique phrases. However, referents of body-parts cannot serve as applied objects (189).

- (189) a. እቲ መምህር ነታ መጽሓፍ
 ?it-i māmīhr n-ät-a mäšḥaf
 Det-3MSg teacher Obj-Det-3FSg book.Sg
 ብቢሮ/ብእጁ ጽሒፉዋ ።
 bi-biro/bi-?id-u ṣihif-u-wa
 Instr-pen.Sg/Instr-hand.Sg-Poss.3MSg PerfS.write-SM.3MS-OM₁.3FSg
 ‘The teacher wrote the book with a pen/his hand.’
- b. እቲ መምህር ነታ ቢሮ/*እጁ መጽሓፍ
 ?it-i māmīhr n-ät-a biro/*?id-u mäšḥaf
 Det-3MSg teacher Obj-Det-3FSg pen.Sg/*hand.Sg-Poss.3MSg book
 ጽሒፉላ ።
 ṣihif-u-la
 PerfS.write-SM.3MSg-OM₂.3FSg
 ‘The teacher wrote a book with the pen/*his hand.’

The oblique expression can be associated with the *biro* ‘pen’ or the *?id-u* ‘hand’ as the referent of the instrumental argument (189a), but an applied object can only be associated with a distinct and referential instrument, therefore, body part referent *?id-u* ‘hand’ is not acceptable (189b), since it has a mereological relation to the subject referent.

The oblique expression of an instrumentalized human argument can be coded with the instrumental preposition, but only with a causative verb form. Thus, an instrumentalized human argument can only be interpreted as a causee argument rather than an instrument, as in (190).

- (190) a. እቲ መምህር ነታ መጽሓፍ ብተመሃሮ
 ?it-i māmīhr n-ät-a mäšḥaf bi-tämāhar-o
 Det-3MSg teacher Obj-Det-3FSg book Instr-student-PI
 ኣጽሒፉዋ/*ጽሒፉዋ ።
 ?a-ṣihif-u-wa/*ṣihif-u-wa
 Caus-PerfS.write-SM.3MSg-OM₁.3FSg/*PerfS.write-SM.3MSg-OM₁.3FSg
 ‘The teacher made the students write the book.’
- b. እቲ መምህር ነቶም ተመሃሮ መጽሓፍ
 ?it-i māmīhr n-ät-a tämāhar-o mäšḥaf
 Det-3MSg teacher Obj-Det-3MPI student-PI book
 ኣጽሒፉዎም/*ጽሒፉሎም ።
 ?a-ṣihif-u-wom/*ṣihif-u-wom
 Caus-PerfS.write-SM.3MSg-OM₁.3MPI/*PerfS.write-SM.3MSg-OM₁.3MPI
 ‘The teacher made the students write a book.’

A correct reading of an instrumental oblique expression that has human referents is acquired from the causative verb form (190a). The causee argument can also be coded as a core object through the OM₁ that attaches to a causative verb (190b).

6.3.8 Topic/comment *bizaʿba*

The preposition *bizaʿba* ‘about’ marks topic and stimulus semantic roles. The topic relation can be considered as a subsidiary notion of the instrumental, since *bizaʿba* is composed of the instrumental preposition *bī* and the noun *zaʿba*, which can be translated as ‘issue’, ‘subject’, ‘topic’, etc. With verbs of communication the topic semantic role refers to the subject matter of communication (191a) and (191b), and with verbs of cognition and emotion it refers to the stimulus of mental or psychological processes (191c) and (191d).

- (191) a. ብዛዕባ ንሉ ሓቲቲና ።
bizaʿba g^wal-u ḥatit-u-na
 about daughter-Poss.3MSg PerfS.ask-SM.3MSg-OM₁.1Pl
 ‘He asked us about his daughter.’
- b. ብዛዕባ እቲ ወዲ ኣዕሊልና ።
bizaʿba ʔit-i wädi ʔaʿlil-na
 about Det-3MSg boy PerfS.chat-SM.1Pl
 ‘We chatted/discussed about the boy.’
- c. ብዛዕባኻ ብዙሕ ሓሲበ ።
bizaʿba-ka bizuḥ ḥasib-ä
 about-2MSg a-lot PerfS.think-SM.1Sg
 ‘I thought a lot about you.’
- d. ብዛዕባኻ ተሻሻለ ።
bizaʿba-ka täšaḳil-ä
 about-2MSg PerfS.worry-SM.1Sg
 ‘I am worried about you.’

In (191a) the daughter and in (191b) the boy are understood as the subject matter of the communication events. With verbs of cognition and emotion such as *ḥasib-ä* ‘I thought’ and *täšaḳil-ä* ‘I am worried’ the topic semantic role is perceived to be the object of thought or the stimulus, as in (191c) and (191d).

With some of these verbs the instrumental preposition can alternatively be used to code the topic semantic role. Let us consider the examples in (192).

- (192) a. ብቲ ወዲ ኣዕሊልና ።
bi-t-i wädi ʔaʿlil-na
 Instr-Det-3MSg boy PerfS.chat-SM.1Pl
 ‘We chatted/discussed about the boy.’
- b. ብኣኻ ብዙሕ ሓሲበ ።
bi-ʔaḳa bizuḥ ḥasib-ä
 Instr-2MSg a-lot PerfS.think-SM.1Sg
 ‘I thought a lot of you.’

- c. ብኣኻ ተሻቂሉ ።
 bi-ʔakā täšaḳil-ä
 Instr-2MSg PerfS.worry-SM.1Sg
 ‘I am worried about you.’

The expression with the instrumental preposition has a slightly different nuance. It entails a direct topic or stimulus. For example, in (192a) the boy himself is the topic of discussion, while in (191b) the topic/stimulus has an indirect meaning, i.e. some issue concerning the boy is perceived to be the topic/stimulus of the perception or the emotion experienced by the subject referent. The two readings given in (192b) and in (191c) can be compared to the English readings yielded by *I thought of you* and *I think about you*, respectively. Similarly, the meaning in (192c) implies that the subject referent is worried about the person themselves, whereas in (192c) the subject referent is worried about issues concerning the person.

The stimulus/topic semantic reading can also be conveyed through the applicative coding, as in (193).

- (193) a. ኖናስ ንጎሉ ሓቲቱላ ።
 Yonas ni-g^wal-u ḥatit-u-la
 Yonas Obj-daughter.Sg-Poss.3MSg PerfS.ask-SM.3MSg-OM₂.3FSg
 ‘Yonas asked/enquired about/for his daughter.’
- b. ነቲ ወዲ ኣዕሊልናሉ ።
 nä-t-i wädi ʔaʕlil-na-lu
 Obj-Det-3MSg boy.Sg PerfS.chat-SM.1PI-OM₂.3MSg
 ‘We chatted/gossiped about the boy.’
- c. ንግኻ ሓሲበኻልኻ ።
 ni-ʕakā ḥasib-ä-ka/lka
 Obj-2MSg PerfS.think-SM.1Sg-OM₁/OM₂.2MSg
 ‘I thought about/of/for you.’
- d. ተሻቂሉልኻ/*ኻ ።
 tä-šaḳil-ä-lka/*ka
 DT-PerfS.worry-SM.1Sg-OM₂/*OM₁.2MSg
 ‘I am worried about/of/for you.’

The applied object (193a) can be interpreted as a topic or a beneficiary argument, and the verb can only allow OM₂ for both readings. In (193b) the applied object has a topic argument reading marked by OM₂. However, with the verb in (193c) the topic/stimulus applied object reading is expressed via OM₁, and it implies only the direct topic/stimulus reading, i.e. the person himself is the referent of the topic argument. The OM₂ expresses a beneficiary applied object. On the other hand, the verb in (193d) only allows OM₂ to code both the direct stimulus and the beneficiary argument readings.

6.3.9 Comitative *mis*

The preposition *mis* ‘with’ marks a comitative/accompaniment semantic role (194). According to Luraghi (2003:28), a “prototypical comitative involves an animate agent performing an action together with another animate individuated entity, conceived as performing the same action”. The comitative prepositional phrase can function as an argument or adjunct modifier of agentive predicates. The following examples illustrate that there are important syntactic and semantic differences between comitative arguments and comitative adjuncts.

- (194) a. **ምስ ወዳ መጸጸትና ።**
 mis wäd-a mäsiʔ-a-tna
 Com boy-Poss.3FSg PerfS.come-SM.3FSg-OM₁.1PI
 ‘She came to us with her son.’
- b. **ምስ ወዳ ተማጉት ።**
 mis wäd-a tämag^wit-a
 Com boy-Poss.3FSg PerfS.argue-SM.3FSg
 ‘She argued with her son.’
- c. **ምስ ወዳ ኣሰለለ ።**
 mis wäd-a ʔaʕlil-a
 Com boy-Poss.3FSg PerfS.chat-SM.3FSg
 ‘She chatted with her son.’

In (194a) the comitative argument is not inherently conceptualized in the meaning of the verb *mäsiʔa* ‘she come’, whereas in (194b) and (194c) the comitative argument is entailed by the meaning of the verbs ‘argue/dispute’ and ‘chat’.

In Tigrinya, only verbs that entail a gesture or a reciprocal action allow the applicative coding of comitative arguments. The comitative applied argument plays the role of a reciprocating partner, as in (195). The referents of the applied comitative arguments that are allowed by inherently associative verbs are necessary for the relevant situation to exist, whereas with other types of predicates, the comitative participants are not necessary for the event to exist. These latter types of comitative arguments can only be expressed obliquely. The referent of the comitative applied object is perceived as a subsidiary partner, since the subject referent is perceived as having a leading role in the activity. The comitative applied object is coded with OM₁, which indicates its affectedness status owing to its engagement in the activity described by the verb.

- (195) a. **ንወዳ መጸጸት ።**
 ni-wäd-a mäsiʔ-a-to
 Obj-boy-Poss.3FSg PerfS.come-SM.3FSg-OM₁.3MSg
 ‘She came to/*with her son.’

- b. ንወዳ ተማጉታቶ ።
 ni-wäd-a tämag^wit-a-to
 Obj-boy-Poss.3FSg PerfS.argue-SM.3FSg-OM₁.3MSg
 ‘She argued with her son.’
- c. ንወዳ አዕሊላቶ ።
 ni-wäd-a ?aʕilil-a-to
 Obj-boy-Poss.3FSg PerfS.chat-SM.3FSg-OM₁.3MSg
 ‘She chatted with her son.’

The applicative expression in (195a) cannot express the comitative applied object reading, but it is grammatical on the goal reading. On the other hand, the applicative expressions in (195b) and (195c) code a comitative argument.

As these examples show, oblique expressions can add comitative participants whenever they are semantically appropriate in an event. However, applicative expressions can only code comitative arguments that are required in the event described by the verb. Thus, the oblique coding of a comitative role has a wider scope than the applicative coding of the same role.

6.4 Primary applicative coding

Certain applicatively expressed semantic arguments cannot be obliquely coded. For example, in Tigrinya, maleficiary, possessor and experiencer semantic arguments can only be expressed as applied objects. Tigrinya does not have prepositions for the oblique coding of a maleficiary or an experiencer argument. Similarly, even though possessive verbs are derived from locative expressions, an applied verb that has a locative copula as its basis is exclusively grammaticalized to code a possessor argument. In the remainder of this section we will illustrate primary applicative expressions of the maleficiary, possessor and experiencer arguments.

6.4.1 Maleficiary

- (196) a. እቲ ሰብአይ ነታ ሰበይቲ ቅጭአ
 ?it-i säb?ay nä-t-a säbäyti qiçi?-a
 Det-3MSg man Obj-Det-3FSg woman bread-Poss.3FSg
 በሊዑላ ።
 bäli?u-la
 PerfS.eat-SM.3MSg-OM₂.3FSg
 ‘The man ate her bread on the woman.’

- b. ነታ ሰበይቲ ገንዘብ ጠፊኡዋ ።
 nä-t-a säbäyti gänzäb tǎfi?-u-wa
 Obj-Det-3FSg woman money PerfS.disappear-SM.3MSg-OM₁.3FSg
 ‘The woman, money disappeared on her.’
- c. እቲ ሰብኣይ ነታ ሰበይቲ መጽሐፍ
 ?it-i säb?ay nä-t-a säbäyti mäṣḥaf
 Det-3MSg man Obj-Det-3FSg woman book
 ወሲዱላ ።
 wäsidi-u-la
 PerfS.take-SM.3MSg-OM₂.3FSg
 ‘He took away a book from the woman.’

The suffix OM₂ is interpreted as coding a maleficiary applied object (196a). The meaning of the transitive verb *bäli?u* ‘he ate’ and the possessive marker on the theme object ‘bread’ promote the maleficiary rather than the beneficiary reading of the applied object. Since the verb ‘eat’ cannot be subcategorized for a maleficiary oblique argument, the maleficiary reading is admitted only through the applicative coding. In (196b), since losing money is perceived as a disadvantage, the verb *tǎfi?u* ‘he disappeared’ bears the suffix OM₁ for a maleficiary/affected applied object. The verb may also bear OM₂ to code a beneficiary or a source applied object. The maleficiary and beneficiary arguments cannot be expressed obliquely. On the other hand, the source argument can be expressed in an oblique phrase, as in *kab gäza* ‘from a house’ and *kab ġiba* ‘from a pocket’. Similarly, in (196c) the suffix OM₂ that the verb *wäsidu* ‘he took’ bears can have beneficiary, maleficiary and source applied object readings. The beneficiary and source arguments can also be expressed obliquely, but the maleficiary argument cannot.

6.4.2 Possessor

- (197) a. ንሳባ ከልቢ ኣሎዋ ።
 ni-Saba kälbi ?all-o-wa
 Obj-Saba dog Pres.exist-SM.3MSg-OM₁.3FSg
 ‘Saba has a dog./Lit. A dog exists for Saba.’
- b. *ከልቢ ኣብ ሳባ ኣሎ ።
 kälbi ?ab Saba ?all-o
 dog Loc Saba Pres.exist-SM.3MSg
 ‘A dog exists in/on Saba.’

When the locative copula verb *?all-o* ‘be, exist’ bears the suffix OM₁, it yields a possessive reading (197a). The possessor object can only be expressed in an applicative construction. The oblique paraphrase of the possessive phrase gives a loca-

tive reading, and in (197b) the expression is meaningless since the human referent Saba cannot serve as a filler of a locative argument in this context. However, when the referent of the possessor argument is replaced by a referent that denotes a location, it results in a semantically correct oblique expression, but has a locative rather than a possessive reading (198).

- (198) a. ነታ ገዛ ማዕጺ ኣሎዎ ።
 n-ät-a gäza maʿṣo all-o-wa
 Obj-Det-3FSg house door Pres.exist-SM.3MSg-OM₁.3FSg
 ‘The house has a door./Lit. The house, a door exists for it.’
- b. ኣብታ ገዛ ማዕጺ ኣሎ ።
 ʔab-t-a gäza maʿṣo ʔall-o
 Loc-Det-3FSg house door Pres.exist-SM.3MSg
 ‘There is a door in the house./Lit. In the house a door exists.’

The applied object has a possessor argument reading in (198a). However, the oblique coding has a locative argument reading (198b). Therefore, since the applicative and the oblique expressions code different semantic arguments, they cannot be regarded as paraphrases of each other. The applicative codes a possessor argument with locative copula verbs, while the oblique codes a locative argument.

6.4.3 Experiencer

As was already discussed in section (4.4) object experiencer arguments are regarded as instances of applied objects. The applicative construction is the only means to express these arguments, as in (199)

- (199) a. ጸሚዩኒ ።
 ṣämiy-u-ni
 PerfS.become=quiet-SM.3MSg-OM₁.1Sg
 ‘I feel lonely./Lit. It became quiet for/to me.’
- b. ሰራሕካ ገሪሙኒ ።
 sirah-ka gärim-u-ni
 deed-Poss.2MSg PerfS.surprise-SM.3MSg-OM₁.1Sg
 ‘Your deed/action/work surprised me.’

The object suffix OM₁ in (199a) and (199b) is coreferential with the unexpressed experiencer object arguments. Since Tigrinya lacks a preposition to mark this semantic relation, the same experiencer object as the ones in (199) cannot be coded obliquely. Table 6.1 summarizes the different applicative and oblique markers that Tigrinya employs to code semantic arguments.

semantic role	Oblique case	objective case	Pronominal Suffix
indefinite theme	∅	∅	∅
definite theme	∅	<i>ni</i>	OM ₁
recipient	<i>ni-</i>	<i>ni-</i>	OM ₁
beneficiary	<i>ni-, silā, miʔinti</i>	<i>ni-</i>	OM ₂
incidental locative	<i>ʔab</i>	<i>ni-</i>	OM ₂
implicated locative	<i>ʔab</i>	<i>ni-</i>	OM ₁
incidental allative	<i>nab, ni-</i>	<i>ni-</i>	OM ₂
implicated allative	<i>nab, ni-</i>	<i>ni-</i>	OM ₁
incidental source	<i>kab</i>	<i>ni-</i>	OM ₂
implicated source	<i>kab</i>	<i>ni-</i>	OM ₁
instrumental	<i>bi-</i>	<i>ni-</i>	OM ₂
incidental path	<i>bi-</i>	<i>ni-</i>	OM ₂
implicated path	<i>bi-</i>	<i>ni-</i>	OM ₁
agentive	<i>bi-</i>	∅	∅
cause	<i>bi-</i>	∅	∅
means	<i>bi-</i>	∅	∅
manner	<i>bi-</i>	∅	∅
reason	<i>silā ni, miʔinti</i>	<i>ni-</i>	OM ₂
topic	<i>b-izaʕba-</i>	<i>ni-</i>	OM ₂
comitative/accompaniment	<i>mis-</i>	<i>ni-</i>	OM ₁
maleficiary	∅	<i>ni-</i>	OM ₁
possessor	∅	<i>ni-</i>	OM ₁
experiencer	∅	<i>ni-</i>	OM ₁

Table 6.1: Applicative and Positional Coding

6.5 Conclusion

Tigrinya has distinct prepositions for coding most of the applicatively expressed semantic arguments. However, not all obliquely coded semantic relations can be coded applicatively, and vice versa. Generally, applicatively coded arguments coincide with semantically distinct and definite referents, whereas referents of obliquely expressed arguments or adjuncts are not specified for particular semantic properties, i.e. oblique arguments are not constrained to be definite or animate in order to be obliquely expressed. However, applicative expressions require the referents of applied objects to be highly individuated. Depending on the type of semantic role, the referents of the applied argument possess semantic features such as definiteness and animacy which make them worthy of being cast as applied objects. In addition, for some semantic arguments such as maleficiary, possessor and experiencer, the applicative construction is a basic coding strategy since there are no distinct prepositions for coding these arguments obliquely.

Part III

Morphosyntactic and discourse approaches

CHAPTER 7

Morphosyntactic approaches

7.1 Introduction

In this chapter we aim to show how the morphosyntactic properties of applicative constructions are accounted for in some major linguistic theories. As this study employs LFG as its theoretical framework, we will discuss this approach in detail – specifically LMT, the sub-theory within LFG which deals with argument-function mapping issues. In addition, we will also touch upon the Relational Grammar (RG) and Government and Binding (GB) approaches to this phenomenon.

Following Peterson (2007) we will designate these theories as morphosyntactic approaches since the structure and properties revealed by applied objects are perceived to be morphosyntactic in nature. Applied objects are characterized by structural or functional relations in contrast to discourse relations. Moreover, these approaches refer to both syntactic information (e.g. word order or phrase structure) and morphological information (e.g. case and verbal affixes) in order to identify symmetric and asymmetric relations in grammar even though these approaches differ on the kind of information they assume as fundamental, and the way they use and interpret this information. For example, in GB syntactic configurations are basic, whereas morphology is supplementary, in the sense that it is used to check information which is already present in a syntactic representation (D-structure) (Zaenen and Engdahl 1994:185). For example, lexical entries are provided with subcategorization information, i.e. the type and number of arguments they take, but since the

same information is also contained in the D-structure, this information becomes redundant. The subcategorization information provided in the lexical entry is useful for building a syntactic representation (D-structure) that contains the same information as the lexicon. On the other hand, in LFG none of this information is taken as basic, thus syntactic and morphological information constrain each other.¹ Therefore, the term morphosyntactic is used to emphasize the role of morphology in syntactic analysis (Matthews 2007:254). Conventionally, the term designates a morphological operation that affects the argument structure of a verb either by altering the mapping of grammatical functions to semantic participants or by altering the meaning of semantic participants.

With respect to applicative constructions, these approaches usually attempt to describe the syntactic category of the applied object by parameterizing properties that are assumed to distinguish between different grammatical relations (identified as direct and indirect objects in RG) or functions (identified as primary and secondary objects in LFG). The parameters of variation that are postulated to form a single property of objecthood are composed of syntactic and morphological coding properties. For this reason, these approaches give a lot of weight to the morphosyntactic properties or processes that bring about the applicative phenomenon. The change in discourse construal which motivates the use of an applicative expression and the semantic change that is associated with some applicative readings has been given little attention, however. We will take up the discourse effect of applicative constructions in chapter 9. These formalisms differ in terms of the grammatical processes they postulate as the basic properties in order to predict object asymmetry. In GB the asymmetry between different objects is assumed to result from difference in *Case* or thematic role assignment, whereas in both RG and LFG it is perceived as a difference in grammatical function category. Nevertheless, RG and LFG differ in their views on grammatical functions.

7.2 Morphosyntactic vs. morphosemantic operations

Some authors distinguish between two types of operations identified as *morphosyntactic* vs. *morphosemantic* (Ackerman 1992) or *morphosyntactic* vs. *morpholexical* (Sadler and Spencer 1998). The term *morphosyntactic* refers to processes that affect only the syntactic expression of arguments without affecting their meaning. The op-

¹A general description of how the lexicon and morphology are employed by these approaches is found in Zaenen and Engdahl (1994).

erations that are associated with them are identified as meaning preserving. In contrast, the term *morphosemantic* and *morpholexical* are used for operations that also alter (by adding, deleting or identifying arguments) the *Lexical Conceptual Structure* (LCS) or the lexical semantic representation proper (Levin and Rappaport Hovav 2008b:250). LCS is taken to be the aspect of meaning which is relevant to grammar, but is not expected to contain information about how semantic participants are projected onto syntax. According to Levin and Rappaport Hovav (2008b:2), it refers to “the set of recurring meaning components which determine the range of argument alternations a particular verb can participate in”. This is distinguished from a predicate argument structure (PAS) which refers to the number of arguments that a predicate projects when it appears in actual constructions in its full inflectional and derivational forms, and contains information about how these arguments are projected into syntax (Bresnan 1982a, Marantz 1984, Grimshaw 1990). According to Sadler and Spencer (1998:209), the morpholexical vs. morphosyntactic distinction, and the traditional dichotomy derivation (creating different lexemes) vs. inflection (creating distinct forms of the same lexeme) correspond to some extent, even though in some cases they do not perfectly coincide.

Linguistic phenomena such as dative shift, applicative, locative alternation, locative inversion, passive, causative, resultative etc., which in most of the literature are conventionally regarded as morphosyntactic processes, can also have a morphosemantic effect in a construction. The causative usually effects change in meaning, and can be identified as a meaning changing operation, while the passive is a meaning preserving operation. There is, however, a discrepancy with respect to the placement of the dative shift, a phenomenon similar to the applicative in its function. Levin and Rappaport Hovav (2008a) as well as Sadler and Spencer (1998) classify the dative shift as a morphosyntactic operation, whereas Ackerman and Moore (2001) and Krifka (2004) consider it to be a morphosemantic operation. This disagreement seems to arise for two reasons. First, both the applicative and dative shift are complex processes that can incur either change depending on the language and the verb class or meaning they operate on. Bresnan and Nikitina (2003) argue that non-dative shifted and dative shifted constructions can reflect variations in emphasis, discourse prominence and/or semantics depending upon which type of ditransitive verbs they operate. For example, alternations with the verb *give* affect only the predicate’s argument structure, thus effecting change of emphasis or discourse prominence. In contrast, with the verb *send* the construction codes also a difference of meaning. The expression with the dative PP codes a goal argument as

in *Mary sent the mail to her friend/Oslo*, while the one with the dative NP codes a possessor argument *Mary sent her friend/*Oslo the mail*, (Bresnan and Nikitina 2007, Levin and Rappaport Hovav 2008a). Second, scholars seem to disagree on the degree of meaning change that these operations can bring about. Some view the meaning difference of a predicate with a dative PP and one with a dative NP as just a subtle nuance of the same meaning, and others argue that the subtle meaning difference constitutes a separate LCS (Krifka 2004).

Levin and Rappaport Hovav (2008a) claim that morphosemantic and morphosyntactic processes are coded with distinct affixes. This assumption seems to be supported by the passive and causative operations, which, in most languages, are coded with distinct morphemes. However, Kroeger (2007) argues that Indonesian provides evidence against this. He points out that the *-kan* suffix in Indonesian can have different effects on the argument structure of a predicate. It can effect semantic and/or syntactic modifications. Its morphosyntactic function is observed in ditransitive verbs which mark beneficiary applicatives whose primary object bears a beneficiary role. Its morphosemantic function involves a variety of meanings. Its most salient function is to produce monotransitive verbs with the semantic structure CAUSE–BE–AT when is associated with intransitive verbs that denote motion and change of state.

A similar effect is observed in Tigrinya. The suffixes OM₁ and OM₂ can be compared in terms of the morphosyntactic vs. morphosemantic distinction. OM₂ usually effects morphosyntactic modification, whereas OM₁ can mark modification of both types, as illustrated bellow (200).

- (200) a. እታ ሰበይቲ ናብ/*ን እቲ ገዛ/ቀልጻ ገደያ ።
 ?it-a säbäyti nab/*ni/ ?it-i gäza/qolfa gäyiy-a
 Det-3FSg woman ALL/*DIR Det-3MSg house/child PerfS.run-SM.3FSg
 ‘The woman ran to(ward) the house/child.’
- b. እታ ሰበይቲ ነቲ ቀልጻ/*ገዛ ገደያትሉ ።
 ?it-a säbäyti n-ät-i qolfa/*gäza goyiy-a-tlu
 (Obj-)3FSg woman Obj-Det-3MSg child/*house PerfS.run-SM.3FSg-OM₂.3MSg
 ‘The woman ran for the child/*house.’
- c. እታ ሰበይቲ ነቲ ቀልጻ/*ገዛ ገደያቶ ።
 ?it-a säbäyti n-ät-i qolfa/*gäza goyiy-a-to
 (Obj-)3FSg woman Obj-Det-3MSg child/*house PerfS.run-SM.3FSg-OM₁.3MSg
 ‘The woman ran/chased the child/*house.’

Neither example (200b) nor (200c) can be interpreted as an alternative expressions to (200a) for coding a goal applied object. Example (200a) shows that only

the allative reading is allowed in an oblique expression. The directional preposition yields an objective case reading when it is associated with definite/animate referents, thus it cannot mark an oblique expression of the beneficiary. The applicative is a basic construction for coding a beneficiary argument with intransitive verbs, as in (200b). Moreover, the application of a beneficiary argument (marked with OM_2) does not change the meaning of the base verb. On the other hand, the application of an affectee object through the OM_1 changes the initial meaning of the verb. In the resulting applicative expression (200c) the applied verb denotes running with the intention of catching someone who is running away from the pursuer. The applied object argument can only be filled with referents that have the ability to run. Therefore, the suffix OM_1 not only augments the number of arguments in the predicate's argument structure, but also changes the LCS.

Assigning a certain grammatical process to a morphosyntactic or morphosemantic operation may involve a theoretical commitment in some of theoretical approaches. For example, in GB the assumption that alternating constructions (e.g. the dative PP and NP dative expressions of a recipient argument) encode the same meaning leads to a derivational representation of the phenomena. This also applies to the incorporation theory formulated by Baker (1988a) to account for operations such as the applicative that are signaled by morphology. However, since LFG creates a separate level of representation that interfaces between the semantic representation of participants and their syntactic manifestations, the distinction between morphosyntactic and morphosemantic phenomena is already embodied in the theory. The different syntactic realizations of semantic arguments are not configurationally tied to each other in this formalism. In the remainder of this chapter we will discuss how the three approaches view the applicative phenomenon and how they analyze it.

7.3 Relational grammar approach

Relational Grammar (RG), like LFG, diverged from the mainstream of generative grammar, and in particular, from standard transformational grammar (TG), an early version of generative grammar developed by Chomsky (1957, 1965). RG was developed to find for alternative ways to account for relation-affecting constructions in a non-transformational way. Postal and Perlmutter laid much of the groundwork of RG in the early 1970's (Perlmutter and Postal 1974). A complete form of the theory appeared in publication in 1983 in a collection of papers such as Aissen (1983),

Chung (1983), Dryer (1983), Perlmutter and Paul (1983) edited by Perlmutter. As its name indicates, RG is portrayed as the theory of grammatical relations (such as subject, direct object and indirect object). Grammatical relations are viewed as primitive notions of the theory in terms of which rules, principles and constraints are formulated. Even though RG has waned in popularity, since it has influenced a lot of current approaches, including LFG, it will be worthwhile to review some of the core issues that the theory raises with regard to applicative constructions. Moreover, since RG has emphasized phenomena affecting grammatical relations from its outset, it has made an enormous contribution to our understanding of constructions such as the passive, dative shift and the applicative.

The main goal of the theory is to show that a derivational relationship holds between alternating sentences. RG seeks to give a cross-linguistic characterization of these issues. A considerable number of studies have been conducted to account for such phenomena, for example, applicatives in Indonesian (Chung 1976), Chicheŵa (Trithart 1976, 1983), Kinyarwanda (Kimenyi 1980, Gary and Keenan 1977, Dryer 1983), Luyia and Mashi (Gary 1977), Tzotzil, Mayan (Aissen 1983) and Halkomelem (Gerdtts 1980, 1988); passives in Turkish and Russian (Perlmutter and Postal 1977); antipassives in French (Postal 1977), and a cross-linguistic perspective of impersonal passives and unaccusatives (Perlmutter 1978), among others.

RG seeks to account for the primitive grammatical relations that elements in a clause may have. A P(predicate) is a relation assumed by predicates, a TERM is a relation assumed by arguments such as the Subject (SUBJ or 1), the Direct Object (DO or 2) and the Indirect Object (IO or 3), and an Oblique is a relation assumed by adjuncts (Blake 1990, Van Valin 2001). The numbering system (1, 2 and 3) is used to describe the relationship between predicates and arguments. Arguments are ordered hierarchically as $1 > 2 > 3 > \dots > \text{non-terms}$ (Oblique, Chômeur). The subject is identified as the highest grammatical relation, and the hierarchy codes a decrease in prominence. Moreover, RG stipulates a special relation known as Chômeur for a term that has lost its term properties or has become idle or retired assuming a non-term relation, as stated in the Motivated Chômeur Law (Perlmutter and Postal 1974). This relation arises when a grammatical relation assumed by a certain dependent of a clause is taken up by another dependent of the same clause in the succeeding level of derivation, as stated in the Relational Annihilation Law in (201) (Perlmutter and Postal 1974).

- (201) When an NP, NP_i , assumes the grammatical relation borne by another NP, NP_j ($i \neq j$), then NP_j ceases to bear any grammatical relation whatsoever. Such NP_j are called 'Chômeur'.

The theory assumes a consistent mapping between semantic roles and initial grammatical relations as proposed by the Universal Alignment Hypothesis (Perlmutter and Postal 1983). Accordingly, the initial term relations 1, 2 and 3 map to the agent, the theme/patient and the recipient, respectively, while the non-terms, oblique and adjunct, map to the beneficiary, locative, instrumental, etc. at the initial level. The theory assumes a number of syntactic representations that indicate the derivational levels or strata in which some of the grammatical relations go through reevaluation (Rosen 1984). In this process grammatical relations assume a new relation either by advancement (i.e. assuming a higher grammatical relation) or demotion (i.e. assuming a lower grammatical relation). For instance, passive (202b) incurs advancement by causing 2 to become 1, and demotion by causing 1 to become a Chômeur (202c). Dative shift (203b) involves advancement causing 3 or an oblique relation to become 2, and demotion causing 2 to become a Chômeur (203c).

- (202) a. The monkey ate the banana. (active)
 b. The banana was eaten by the monkey. (passive)
 c. eat the monkey the banana =analysis
 P 1 2 initial
 P CHÔMEUR 1 final
- (203) a. The baboon gave the banana to the monkey. (PP recipient)
 b. The baboon gave the monkey the banana. (NP recipient)
 c. give the baboon the banana the monkey =analysis
 P 1 2 3 initial
 P 1 CHÔMEUR 2 final

The theory does not pose a separate level of representation for lexical semantics. Grammatical relations at the initial level of representation (i.e. initial grammatical relations) are motivated on semantic grounds. As a result, there is no clear distinction between semantic roles and initial grammatical functions. The analysis of a construction that does not reflect a canonical mapping is derivationally accounted for by starting from the initial level. RG, like GB, posits a derivational relationship between pairs of sentences. Consequently, the theory assumes that there is meaning equivalence between the pairs that are assumed to be related by derivation.

The more RG included empirical data from various languages, the more the theory become confronted with conflicting conclusions about the nature and status

of the objects it postulates, and about how these should be represented in a linguistic theory. In particular, the variations observed in applicative data across languages were instrumental in the reformulation and change of important rules and principles proposed by RG's.

Chung's (1976) account of dative constructions in Bahasa Indonesia is considered to be the first printed account of RG's standard approach to applicatives. The constructions that Chung designates as *dative* are comparable to applicatives elsewhere. According to Chung the dative sentence in Bahasa Indonesia codes a beneficiary or a dative argument as a DO. The dative or beneficiary object is advanced from an initial IO which occurs with the dative preposition *kepada* 'to' or the benefactive preposition *untuk* 'for'. She formulates a *dative rule* which is assumed to account for the creation of dative/beneficiary DOs from dative/beneficiary IOs. The dative rule causes the IO to lose its prepositional marking and the verb to acquire the benefactive suffix *-kan* instead, as in (204) (Chung 1976:41).

- (204) a. Saja mem-bawa surat itu kepada Ali.
 I Trans-bring letter the to Ali
 'I brought the letter to Ali.'
- b. Saja mem-bawa-kan Ali surat itu.
 I Trans-bring-Ben Ali letter the
 'I brought Ali the letter.'

In (204a) *Ali* is initially identified as the IO, whereas in (204b) it is advanced to DO. The dative rule deprives the initial DO *surat* 'letter' of its object properties, and thus causes it to become a Chômeur.

Chung (1976:42) established some diagnostics to show that the permuted dative object is indeed the true DO. She states that DOs have the ability to appear as a bare or prepositionless NP, to occur in immediate adjacency with the verb, to become a subject in passivization, to be reflexivized with the subject, to be preposed, to control equi deletion and be relativized. Since the dative object in dative constructions controls these properties, it is analyzed as DO, whereas the initial DO becomes a Chômeur since the dative rule bars it from acquiring these properties.

Later, Gary and Keenan (1977) challenged the Chômeur analysis in their well-known work on applicatives in Kinyarwanda. They also posited two direct object relations in this language, consequently challenging the Stratal Uniqueness Law of Perlmutter and Postal (1977) which states that no more than one NP in a clause can bear the same grammatical relation at the same level of derivation. They maintain that Kinyarwanda has an obligatory dative rule which promotes the IO to DO with-

out entailing a demotion of the underlying or initial DO, as shown in (205) (Gary and Keenan 1977:91).

- (205) a. Yohani y-ohér-er-eje Maria ibaruwa
 John he-sent-R-asp Maria letter
 'John sent Maria a letter.'
- b. Yohani y-ohér-er-eje ibaruwa Maria.
 John he-sent-R-asp letter Maria
 'John sent Maria a letter.'
- c. Yohani y-a-yi-mw-ohér-er-eje.
 John he-past-it-her-sent-R-asp
 'John sent it to her.'

As examples (205a) and (205b) show, both objects appear as bare NPs, without any case or prepositional markers, and both can occur in the immediate postverbal position. As example (205c) shows, both objects can simultaneously be indexed on the verb. Both objects can be advanced to a subject relation in passivization and be topicalized through relativization. Thus, Gary and Keenan (1977) argue that there are two DOs in Kinyarwanda double object constructions.

However, Gary and Keenan's claim has raised debate among researchers in RG and outside it. Perlmutter and Postal (1983) argue against the two DO analysis. In their opinion, since the two objects are not distinguished by structural or/and morphological coding, the double object constructions in Kinyarwanda are ambiguous in their reading. For example, they analyze sentence (205a) as corresponding to a clause in which 3 is advanced to 2 and sentence (205b) to a clause that codes initial 2 and 3 in which none of these is advanced. They also point out that in a passive construction, the recipient advances from 3 directly to 1 without forcing 2 to become a Chômeur. This kind of observation led Perlmutter and Postal (1983) to abandon the Chômeur law which demands that all demotions are to the Chômeur relation. Instead, they propose a new demotion rule for symmetrical languages where the advancement of 3 to 2 allows the initial 2 to retreat to 3. Even though their proposal can account for object variations found in symmetrical and asymmetrical Bantu languages, as has been noted by Bresnan and Moshi (1993), it does not offer a unified account of applicative constructions. Firstly, variations that arise due to different semantic roles within a language and across languages must be specified on a rule-by-rule basis, which can result in numerous advancement rules. Secondly, even though Perlmutter and Postal assume that the patient and recipient objects are somehow distinct, they do not offer any mechanism that can distinguish between them.

Similarly, Dryer (1983) and Polinsky (1995) maintain that DO and IO are distinct grammatical relations in Kinyarwanda, contrary to the claim made by Gary and Keenan (1977). Dryer identifies subtle differences between the two objects. For example, these objects show different grammatical behavior in double object clauses with morphological causative and advanced locatives. When an advanced locative co-occurs with an underlying DO, the underlying DO assumes a *Chômeur* relation; but when the advanced locative co-occurs with a benefactive object, the benefactive retains its object properties. Moreover, when both a DO and an IO appear in a clause, the IO tends to precede the DO, and when affixes for both objects are incorporated in the verb stem, the affix that coincides with DO precedes that of IO's. Dryer (1983) points out that the object relations that appear indistinct in Kinyarwanda are a small set of double object constructions that involve an underlying theme object and a benefactive object.² Thus, he claims that Gary and Keenan's argument is based on double object constructions that involve only these objects. In these constructions the DO and the IO are very similar in their syntactic properties; however, according to Dryer this cannot be used as grounds for assuming that they are the same grammatical relation. Moreover, he maintains that the range of properties that are employed as diagnostics of objecthood do not characterize the DO alone, but that they can also be shared by the IO.

Later, Dryer (1986) introduced primary object (PO) and secondary object (SO) categories on a level with the DO and IO relations. The PO and SO are comparable to the OBJ and OBJ2 proposed by Bresnan (1982a) in LFG. Dryer (1986) employs a monostratal analysis of double object constructions. He argues that some languages are best accounted for in terms of the PO and SO distinction, and others in terms of the DO and IO distinction. According to him, the IO and DO distinction is based more on semantic notions, while that between PO and SO is based on discourse notions, irrespective of the semantic roles they bear (Dryer 1986:841). Languages that make the distinction between PO and SO treat the recipient/beneficiary object argument of ditransitive clauses and the undergoer/patient argument of monotransitive clauses alike. On the other hand, languages that make the DO and IO distinction code only the theme argument of ditransitive clauses like the undergoer/patient argument of monotransitive clauses. The former corresponds to the *primitive and secundative* and the latter to the *directive and indirective* alignment types accord-

²In Dryer's terminology the benefactive object category is used as a cover name for object relations that may bear a recipient, a beneficiary or a goal semantic role. These objects are also known as dative arguments.

ing to Haspelmath (2004, 2008) and Malchukov et al. (2007). Dryer (1986:811) points out that some languages do not exhibit the kind of alternation that languages such as English and Bahasa Indonesia have. He says that French employs a single construction to express a notional IO (i.e. an object with either a recipient or a beneficiary semantic role). French expresses the recipient/beneficiary argument in a way similar to how such argument is expressed in the English non-dative shifted construction. Languages such as French therefore lack an IO advancement, and they reflect a DO and IO alignment. Some languages may not have prepositional markers to express notional IOs (recipients and beneficiaries), thus object relations are expressed in a basic double object clause. In RG these languages are thought to have obligatory 3 to 2 advancement, and they reflect the PO and SO alignment. Haspelmath (2008:3) also recognizes a third type known as the neutral alignment. In this alignment type, both the theme and the recipient arguments are similar in their coding and grammatical properties.

The PO and SO distinction accounts for the fact that when the IO is advanced to DO, the notional (theme/patient) object still retains some of the DO properties of objecthood, and thus does not assume a Chômeur relation. Dryer (1983, 1986) allows a Chômeur analysis or a kind of demotion that he calls an ‘antidative’ of the IO in languages that mark this relation as an adpositional oblique. The Chômeur analysis is illustrated with the active-passive alternation in Swahili (206) and the ditransitive coding in English (207).

(206) Swahili: active-passive alternation (Dryer 1986:835-36)

a. *active*

Jony	a-li-m-p-a	mkunga	ZWADI.
John	he-PAST-give-her-ASP	nurse	present
SUBJ		PO(IO)	SO(DO)

‘John gave the nurse the present.’

b. *passive*

Mkunga	a-li-p-ew-a	ZWADI	na	Johni.
nurse	she-PAST-give-PASS-ASP	present	by	John
SUBJ		SO(DO)	Chômeur	

‘The nurse was given the present by John.’

(207) English: ditransitive (Dryer 1986:821)

John	gave	the book	to	Mary.
Initial	SUBJ	DO(SO)	IO(PO)	
Final	SUBJ	DO(PO)	Chômeur	

The PO in (206a) corresponds to the notional IO. In Dryer's analysis, this clause is considered basic. Another interesting point about Dryer's analysis is the relation assigned to the notional DO, as in (206b). Dryer argues that since the passive verb cannot agree with an object, this object cannot be analyzed as PO, thus it is analyzed as the SO. In the antituitive analysis, he considers the clause where the recipient is expressed as DO/PO to be the basic or initial one, similar to the Swahili structure (206a). For this reason, he analyzes the recipient argument in the non-dative shifted clause as a demoted or a *Chômeur* relation, as in (207). In RG subcategorizable object arguments cannot be analyzed as obliques since this relation is assigned to non-terms or adjuncts.

In languages that reflect symmetrical object relations the adoption of the PO and SO distinction does not solve the puzzle of objects that appear to be similar. In many languages, there are no sufficient and convincing grammatical properties that differentiate them. Nevertheless, since formal theories such as RG and LFG posit a uniqueness principle to block the occurrence of two or more objects that have the same relational or functional properties, they assume that these objects can be discerned in some way. On the other hand, since their similarity is more salient than their difference, there are linguists who recognize the neutral status of symmetric objects. For instance, Haspelmath (2008:98) argues against Dryer's (1983, 1986) claim of distinct object relations in Kinyarwanda and other similar languages. He states:

Unfortunately, this claim is immune to falsification in practical terms: There is no way one could exhaustively examine all possibly relevant constructions to determine whether they privilege one of the two arguments, so one can always claim that there is probably some construction with respect to which R and T differ, even though it hasn't been discovered yet.

Moreover, Baker (1988a), Marantz (1984) and Bresnan and Moshi (1990) criticize RG for not being able to capture properties that applicative constructions have in common both within a language and across languages. In this theory, it is assumed that the differences reflected in applicatives with beneficiaries, locatives, instrumentals, etc., are due to different applicative rules. Therefore, the theory postulates multiple independent rules to handle the variants. With regard to this Bresnan and Moshi (1990:61) say:

Unfortunately, this approach does not capture the relationships between these various object properties: it must be specified rule-by-rule whether 2's [DO's] or both 2's and 3's [IO's] are referenced.

Nevertheless, RG made important contributions to language description and analysis. Many linguistic theories make direct or indirect reference to RG in their theoretical formulations. As we shall see in the remainder of this chapter, most of the diagnostics that many theories employ to identify symmetry/asymmetry properties in grammatical relations were first established by RG owing to Chung's 1976 research on Bahasa Indonesia.

7.4 Government and Binding approach

Government and Binding (GB) was the most influential theory developed by Chomsky (1981). In GB Chomsky proposed a major revision to the generative theory he had developed in successive versions since the 1950's (Chomsky 1957, 1965). The main endeavor of the theory is to investigate the aspect of grammar which is common to all languages. This aspect of grammar is known as Universal Grammar (UG). GB assumes a modular approach which is characterized by derivation. UG is assumed to have two components: levels of representation and a system of constraints (Black 1997b). A syntactic representation in GB consists of four different levels:³ *underlying or D(eep)-structure*, *S(urface)-structure*, *Phonetic Form (PF)* and *Logical Form (LF)*. This model is schematized in Figure 7.1 based on Chomsky (1986:68) (see also Black (1997a)).

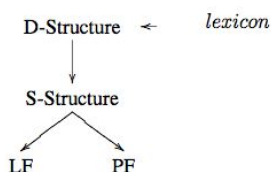

Figure 7.1: The GB model

³Originally, Chomsky (1981:17) devised a model of UG which consists of three components: the rules of syntax and the two types of interpretive rules, one that links S-structure to PF and another that links S-structure to LF. Syntax consists of a *base* that generates the D-structure. The base in turn consists of a *lexicon* and a *categorical component*. Transformational rules convert the D-structure to S-structure. Moreover, the S-structure is indirectly associated to PF and LF through the systems of interpretive rules.

The base component generates an infinite class of D-structures. The D-structure is the most influential component of the GB module. It is similar to the initial level of analysis in RG. It functions as an abstract representation of the semantically relevant grammatical relations such as logical subject and logical object (Chomsky 1986:67). The D-structure functions as the interface between the store of lexical knowledge and the syntactic representation (Zaenen and Engdahl 1994). The lexicon contains information on s(ematic)-selection or thematic (θ) roles, i.e. information about the type and number of arguments that a lexical item can be subcategorized for.

A generalized transformational rule of the type *move- α* transforms the D-structure into a representation similar to the actual surface form, the S-structure. The rule *move- α* replaced the detailed and specific transformational rules which characterized earlier versions of generative grammar. The variable ' α ' stands for the type of category that is moved or rearranged. In GB *move- α* results in co-indexing two positions in the S-structure indicating the original position and the destination of the moved element (see example 208b). *Move- α* is postulated to guide all kinds of processes that affect default syntactic structures. In theory, it is assumed to allow anything to move anywhere since illegal movements are taken care of by a system of constraints which restrict the movements.

The S-structure cannot be interpreted by itself. It is spelled out through the interpretive rules which are components of PF. PF is a representation of the acoustic and articulatory systems. The transformational component *move- α* also operates on the S-structure in order to derive the representation of the LF which is an interface between the syntactic representation and the conceptual systems of the human brain. For example, it deals with semantic interpretations that are concerned with anaphora and scope. In general, the Chomsky (1981) GB model depicts the association of form and meaning.

GB's approach to applicative constructions is credited to the work of Baker (1988a,b, 1990, 1996). The primary purpose of Baker's work is to explain the interaction between syntax and morphology, and especially to establish the role of morphology within GB. Baker's approach stresses syntactic explanation over morphological explanation. The applicative construction provides relevant data to elucidate the interaction between morphology and syntax. Baker characterizes the applicative operation as a head movement where the applicative morpheme is analyzed as an adposition that moves from its structural position to incorporate into the verb, and thus the noun phrase that is associated with the applied object is li-

censed at its original position (D-structure). This is the position for oblique objects that bear a thematic role such as recipient, goal or beneficiary. This special type of transformational rule is known as incorporation and it is considered as a special instance of move- α to account for the movement or rearrangement of a lexical (X^0) category rather than a phrasal (X') category. Baker (1988a:1) defines incorporation as “a process by which one semantically independent word comes to be “inside”⁴ another”. Baker argues that the applicative phenomenon complies with the same principles that other movements in syntax obey. He considers passives, antipassives, causatives and possessor ascension as instances of incorporation where in most cases the incorporating element is the head (a verb or a noun) and the incorporated element is the head of its phrase. Example (208) illustrates the process of preposition incorporation in the derivation of the applicative expression (this representation is adapted from Baker (1988a:230-231)).

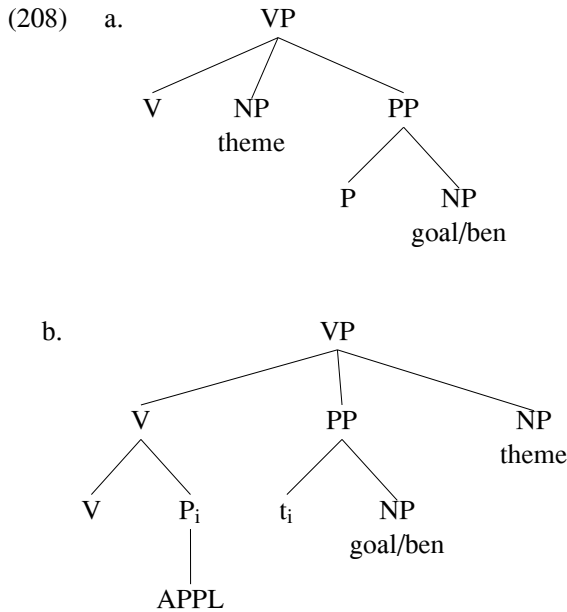

Baker assumes that an applicative expression (208b) is derived from an underlying structure (208a) which is similar to an oblique phrase with the same thematic role in S-structure. In the applicative version, the prepositional element leaves a trace in the position it moves from in order to preserve the structural representation of the argument relationship. In this a way, the movement of a lexical category is

⁴The double quotation is originally used by the author for the purpose of emphasis.

constrained since the trace serves as a device to express ‘proper government’ in accordance with GB’s Empty Category Principle (ECP) (Chomsky 1981:60), which states that traces must be governed. Consequently, the verb requires a PP sister at every syntactic level.

Baker (1988b) explains language internal and cross-language variations in applicative constructions as differences in thematic role and case assignments. He assumes that in Chicheŵa the asymmetrical behavior of beneficiary and instrumental applicatives results from a difference in the assignment of the respective thematic roles at D-structure, and consequently of the assignment of case. He further observes that in Chicheŵa there are significant structural differences between beneficiary and instrumental applicatives. In beneficiary applicatives, only the applied object can be expressed through object prefixes on the verb; however, in instrumental applicatives either object, basic or instrumental, may be indexed through object prefixes on the verb. In addition, either of the objects in instrumental applicatives can be relativized; the beneficiary applied object, however, cannot be relativized. Another structural difference is reflected in their word order. The beneficiary applicative is required to be adjacent to the verb, whereas either of the objects in instrumental applicatives can be placed immediately after the verb. Based on this observation Baker (1988b:362) claims that the instrumental role is assigned as the NP sister of the verb in the same way as theme and patient roles, while the beneficiary is marked as a PP sister of verb, as the structures in (209) show.

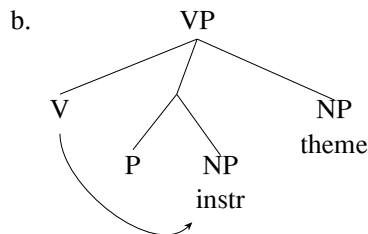
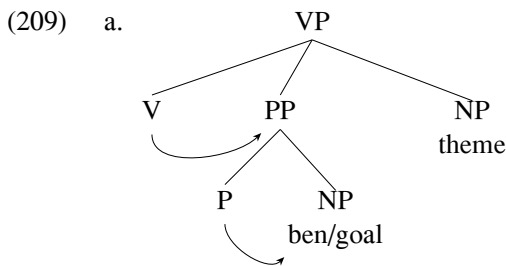

A beneficiary PP is assumed to be a lexical argument of a ditransitive verb, thus it receives its θ -role assignment from the verb at D-structure. Therefore, Baker (1988a:360) hypothesises that for the beneficiary the nature of θ -role assignment is indirect (209a) since it is the PP, not the NP, that receives its θ -role from the verb, whereas for the instrumental the nature of the θ -role assignment is direct (209b) since the verb marks the instrumental NP directly. These differences in D-structure representation determine their behavior in applicatives, as is reflected in (210).

(210) a. *Beneficiary Applicative*

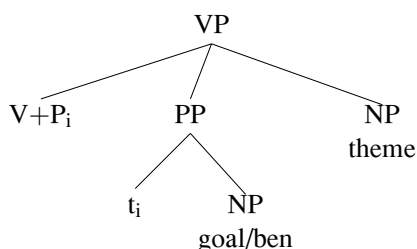

b. *Instrumental Applicative*

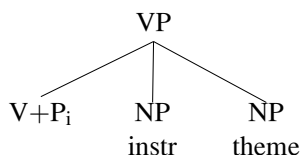

When the beneficiary P moves, it leaves a trace in order to preserve the D-structure representation of a lexically determined thematic structure. On the other hand, when the instrumental P is moved, it need not leave a trace since it does not assign a θ -role of its own. Since the instrumental role is not a lexically determined argument of the verb, it is directly assigned by the verb to the instrumental NP. As a result, the applicative expression of the instrumental argument preserves the D-structure representation (209b).

In addition, Baker (1988b:365) proposes that the asymmetric properties of the assignment of beneficiary and instrumental θ can also be explained from the case assignment point of view. In GB, it is assumed that in order for the structures in (210) to be well-formed, the relevant NPs must receive case. There are two types of

case that an NP may acquire: *structural* and *inherent* (refer to Butt (2006:55-71) for a detailed discussion). Both nominative and accusative are referred to as *structural* cases. A structural case is assigned at S-structure independently of thematic roles. Inherent case is assigned at D-Structure and is closely associated with thematic roles. Languages may employ morphological case or adpositions in order to mark a recipient/goal or beneficiary argument of ditransitive verbs. The UTAH (Uniformity of Theta Assignment Hypothesis) principle formulated by Baker (1988a:46) states that, "Identical thematic relationships between items are represented by identical structural relationships between those items at the level of D-structure." Accordingly, he defines D-structures as "pure representation of thematically relevant Grammatical Functions (=GF-theta)". The nominative case is assigned to the NP which is the specifier of VP, while the accusative case is assigned to the NP which is sister of V. Consequently, grammatical functions such as subject, object and oblique are described in terms of their structural configurations. In this way, Baker (1988a) aims to show that grammatical functions are not primitive concepts in grammar unlike what is assumed in RG and LFG.

The applicative phenomenon poses problems for the case assignment theory. Both S-structure representations in (210a) and (210b) contain two bare NPs which must receive abstract case. However, verbs in languages like Chicheŵa can assign structural case (i.e. accusative, objective or absolutive) to only one NP. Baker thus attempts to account for how the second NP may receive case. In accordance with GB theory, he postulates that since verbs also have the ability to assign inherent case, the second object may get this type of case. He assumes that verbs in Chicheŵa may assign inherent case, in addition to structural case, and thus applicative constructions may employ either of these case systems to account for the well-formedness of the two bare NPs. He specifies which of the NPs is assigned structural case and which one is assigned inherent case in beneficiary and instrumental applicatives.

He explains that at S-structure (210a) the trace of the moved preposition governs the beneficiary applied object; however, since a trace does not have lexical properties, it does not have case features, thus it cannot assign case. Moreover, since the beneficiary applied object is not directly θ -marked by the verb at D-structure (209a), it cannot receive inherent case from the verb. Therefore, according to Baker (1988b:376), the only legitimate case option left for the beneficiary applied object is the structural case, since the requirement for the assignment of this case, that the verb governs the NP at S-structure, is fulfilled. Then, the basic object of the verb receives the inherent case, since it is θ -marked by the verb at D-structure. In other

words, the beneficiary applied object acquires structural case by virtue of adjacency requirements, and the basic object loses its right to have structural case because, in beneficiary applicatives, this object is displaced from its canonical post-verbal position, and is therefore regarded as an adjunct. This analysis is similar to RG's account of the Chômeur relation.

In contrast, the instrumental NP is θ -marked by the verb at D-structure (210b). As a result, just like the patient NP, it receives a lawful inherent case. Furthermore, they can both receive structural case at S-structure (209b), since both are governed by the verb. Therefore, there are two ways in which instrumental and patient NPs may acquire case. In a structure where the instrumental NP comes immediately after a verb, it is assigned structural case, and the theme NP gets inherent case, or vice versa when their word order is reversed.

Even though Baker's theory succeeds in explaining the variations reflected in word order and object marking in Chicheŵa with regard to beneficiary and instrumental applicatives, it has been challenged for making incorrect predictions in explaining the asymmetry displayed by different applied objects in Chicheŵa and across the Bantu typological split. Alsina and Mchombo (1990) reject Baker's theory of theta asymmetry based on extraction facts, intransitive base verbs and locative applicatives. Baker (1988b) assumes that beneficiaries and instrumentals would diverge with respect to extraction based on the D-structure difference he proposed. He predicts that in beneficiary applicative clauses, only the theme/patient object can be extracted, but the beneficiary resists extraction. In instrumental applicative clauses, on the other hand, both the instrumental and the theme/patient objects can be extracted. However, Alsina and Mchombo (1990:496) observe that a beneficiary argument can be extracted in passive clauses in Chicheŵa. Moreover, supporting Bresnan and Moshi's (1993) observation, Alsina and Mchombo (1990:496) point out that Kichaga, as a symmetrical Bantu language, seems to disallow extraction of a beneficiary object in active clauses, but allows it in passive clauses. Thus, Alsina and Mchombo (1990) assert that extraction is possible in the structural configuration that Baker (1988b) proposed as evidence of asymmetric properties in Bantu applicatives.

Moreover, Alsina and Mchombo (1990) point out that Baker makes an incorrect prediction about the formation of beneficiary applicatives from intransitive base verbs. Baker (1988b) predicts that, in Chicheŵa, beneficiary applicative markers cannot attach to intransitive verbs since intransitive verbs (verbs which are not lexically subcategorized for an object) cannot assign structural case and the beneficiary

applicative suffix does not have a case feature. Instrumental applicative markers can assign structural case, however, since instrumental applicative suffixes bear case features. Alsina and Mchombo (1990) state that the general tendency is that beneficiary and instrumental applicatives reflect varied properties when they attach to transitive verbs that optionally omit the patient/theme arguments with an interpretation of an indefinite, generic or prototypical object. In beneficiary applicatives, transitive verbs do not allow the patient/theme arguments to optionally be omitted (211a) and (211b); however, this is possible with instrumental applicatives (211c) and (211d) (Alsina and Mchombo 1990:500).

(211) a. *beneficiary*

mlēnje a-ku-lémb-ér-a mfúmú *(chimangirīzo)
 1-hunter 1 SM-Pres-write-Appl-FV 9-chief 7-essay
 ‘The hunter is writing for the chief.’ (OK with ‘an essay’)

b. *beneficiary*

msōdzi a-ku-phík-ír-a aná *(nyēmba)
 1-fisherman 1 SM-Pres-cook-Appl-FV 2-children 10-beans
 ‘The fisherman is cooking for the children’ (OK with ‘beans’)

c. *Instrumental*

mlēnje a-ku-lémb-ér-a nthēnga (chimangirīzo)
 1-hunter 1 SM-Pres-write-Appl-FV 9-feather 7-essay
 ‘The hunter is writing (an essay) with a feather.’

d. *Instrumental*

msōdzi a-ku-phík-ír-a mthíko (nyēmba)
 1-fisherman 1 SM-Pres-cook-Appl-FV 3-ladle 10-beans
 ‘The fisherman is cooking (beans) with the ladle.’

Alsina and Mchombo (1990:501–502) also dismiss Baker’s assumption that the meaning of applicatives with basic intransitive verbs has a noticeable reason/motive reading rather than a beneficiary reading. They argue that beneficiary and reason/motive applicative constructions reflect significant differences. Although reason/motive arguments can allow the applicative suffix (*lír*) and can be expressed as bare NPs (212a), they cannot be indexed with object markers (*wá*) (212b) and cannot be expressed as subject functions in passive clauses (212c).

(212) a. Chitsíru chi-ku-lír-ír-a mǎntha

7-fool 7 SM-Pres-cry-Appl-FV 6-fear
 ‘The fool is crying for fear.’

b. *Chitsíru chi-ku-wá-lír-ír-a (mǎntha)

7-fool 7 SM-Pres-6 OM-cry-Appl-FV 6-fear

- c. *mǎntha a-ku-lír-ír-ǐdw-a (ndí chitsîru)
6-fear 6 SM-Pres-cry-AP-Pass-FV by 7-fool

On the other hand, beneficiary applicatives do allow object markers (213a) and the beneficiary argument can be associated with the subject in passive clauses (213b).

- (213) a. Yêsu a-ná-wá-f-er-a (anthu).
1-Jesus 1 SM-Past-2 OM-die-Appl-FV 2-people
'Jesus died for them (the people).'
- b. Ānthu a-ná-f-ér- dw-a (ndí Yêsu).
2-people 2 SM-Past-die-Appl-Pass-FV by 1-Jesus
'The people were died for (by Jesus).'

Based on that observation, Alsina and Mchombo (1990) conclude that, in Chicheŵa, beneficiary applicatives can be formed out of intransitive bases. In fact, such counterexamples prompted Baker (1996) to change his claim from a general restriction on intransitive bases for beneficiary applicatives to a restriction on unaccusative bases (refer to chapter 5 for more discussion concerning applicative formation from intransitive verbs).

Baker (1988b) also assumed that beneficiary and locative applicatives appear similar in their structure. Alsina and Mchombo (1990) demonstrate that locatives are more similar to instrumental applicatives in word order, object marking, relativization and indefinite object deletion, than they are to beneficiaries. The only behavior that the locative and the beneficiary have in common is that both arguments can appear as subjects in passivisation. Baker (1988b) claims that locatives, like beneficiaries, are θ -marked by a preposition, thus they receive structural case which allows them to display object properties.

Moreover, Baker's claim that the applied verb in asymmetrical languages such as Chicheŵa has no potential to assign a structural case, while the applied verb in symmetrical languages such as Kichaga can assign structural case cannot account for the asymmetric properties reflected in the Bantu typological divide in a unified manner. Baker assumes that since grammatical processes such as object marking and passivization absorb the verb's structural case, they affect only one object, the applied object, in asymmetrical languages, whereas in symmetrical languages they may affect both objects. In this way, the capability of an object to display object properties is associated with structural case. He assumes that since in Chicheŵa the beneficiary marker can assign only inherent case, there is only one object that

displays object properties. On the other hand, in languages such as Kinyarwanda, since the beneficiary marker has a potential to assign an additional structural case, both objects may display object properties in applicative constructions. Bresnan and Moshi (1993) argue that even though Baker's (1988b) proposal can explain many of the asymmetrical properties in Bantu applicatives, it fails to explain several similarities in languages such as Chichewa and Kichaga. For example, in both languages, the beneficiary applied object is required to be adjacent to the verb. The behavior of their beneficiary and locative applicatives is similar in terms of word order and long-distance extraction. Consequently, Baker's proposal cannot explain similarities such as these.

To sum up, by accounting for grammatical relation changing phenomena as instances of incorporation, Baker wants to emphasize that structural configurations are responsible for changes in government or case relations. Consequently, he argues that grammatical functions such as subjects and objects cannot be considered as primitive concepts in syntactic theory, contrary to what RG and LFG postulate. In the next section we will consider how applicatives are accounted for in LFG.

7.5 LFG's LMT approach to applicatives

Lexical Mapping Theory (LMT) is a special sub-theory within the LFG framework which was developed in subsequent studies by Levin (1988), Bresnan and Kanerva (1989), Bresnan and Moshi (1990), Alsina (1990), Alsina and Mchombo (1993) and Zaenen (1993) in order to account for constructions that reflect a non-canonical association of thematic roles to grammatical functions. LMT is a theory of correspondence between thematic structures and grammatical functions. LFG assumes that alternative mappings arise from constraints that are simultaneously imposed by the constituent, functional, thematic and discourse structures of an expression and the principles that relate them. Mapping principles deal with the relatedness of these parallels, and, at the same time, independent representations of a sentence. The two types of correspondence principles that have been dealt with extensively in the LFG literature are: constituent structure (c-structure) to functional structure (f-structure) mapping and argument structure (a-structure) to f-structure mapping. The former was discussed in chapter 3, and the latter will be the theme of this section.

The purpose of adding an independent a-structure representation to LFG's architecture is to provide more semantic information which is not sufficiently accounted for by the c-structure and f-structure representations. It is assumed that

lexical entries of predicators provide information concerning the thematic structure of arguments, mainly about their syntactic realization, and LMT works out the pattern of correspondence between thematic roles and grammatical functions.

LMT proposes a radically different idea from the derivational approaches discussed in sections 7.3 and 7.4. The theory employs syntactic underspecification as a mechanism for factorizing the mapping possibilities available for the arguments of a predicator. Moreover, it provides mapping principles and well-formedness conditions that determine the association of semantic roles and grammatical functions. Below we will discuss the most relevant components of LMT.

7.5.1 Argument structure and thematic roles

In LFG the a-structure has been identified as a distinct level of representation that mediates or interfaces between semantics and syntax. As stated in Zaenen and Engdahl (1994:192) as well as Bresnan (2001:304), an a-structure has both semantic and syntactic dimensions. These dimensions correspond to the semantic valency and syntactic valency distinctions discussed earlier in chapter 5.1. On the semantic dimension, the a-structure is the representation of the core participants in events (states, processes, activities) designated by a single predicator. Commonly this information is represented by a predicator with its core participant roles listed inside angled brackets, as in (214).⁵ Participant roles are labeled with generalized thematic/semantic role names such as *agent*, *theme/patient*, *beneficiary/recipient*, *goal*, *locative* etc.

- (214) a. pound <agent, theme>
 b. freeze <theme>

Standard LMT assumes that the thematic roles inside the angled brackets are ordered according to a presumably universal hierarchy.⁶ Bresnan and Kanerva (1989) adopt the thematic hierarchy in (215) which was first proposed by Kiparsky (1987).

⁵Some researchers in LFG (Butt 1995, 1997, Broadwell 1998) have also adopted Jackendoff's (1990) lexical semantics representation formalism known as Lexical Conceptual Structure (LCS). The a-structure proposed by them is elaborated and enriched with semantic information which is indexed to syntactic realization at f-structure.

⁶What is referred to as standard LMT here is the version which was first developed by Levin (1988) and then enriched by Bresnan and Kanerva (1989). The theory was further extended in subsequent research on Bantu applicative constructions (Bresnan and Moshi 1990, Alsina and Mchombo 1993).

- (215) Agent < Beneficiary < Recipient/Experiencer < Instrumental <
Patient/theme < Locative

The agent is ranked as the most prominent role and the locative as the least prominent role in the hierarchy. However, there is no broad consensus among linguists on how certain roles should be ordered, nor on the use of discrete semantic role labels such as agent, theme/patient, beneficiary/recipient etc. in the a-structure. It is beyond the scope of this work to discuss the various proposals for a thematic hierarchy, but it would suffice to say that the universality of this thematic hierarchy is strongly debated (refer to Butt (2006) for a detailed discussion). In fact, Butt (2006:122) points out that current work on LMT makes no crucial reference to the thematic hierarchy, since linking between thematic roles and grammatical functions is achieved through a feature system. For example, Zaenen (1993) and Kibort (2004, 2007, 2008) do not assume a universal thematic hierarchy. Some studies have also proposed a language specific hierarchy, for example, Huang (1993) for Chinese and Nazareth (2007) for Tigrinya, in order to accommodate the object properties reflected by these languages. Some researchers, for example Dowty (1991), question the use of discrete semantic role labels for capturing information on semantic participants arguing that semantic participants should be viewed as a set of semantic entailments of the predicate, not as discrete thematic roles which are part of the lexical entry of verbs (Dowty 1991). Researchers such as Zaenen (1993) and Alsina (1990) follow Dowty using the general labels such as proto-agent, proto-patient properties, etc. to identify different semantic participants.

In the syntactic dimension, the a-structure is the representation of the minimal information about predicates which is necessary for deriving their syntactic dependents (Bresnan and Zaenen 1990, Zaenen and Engdahl 1994). In other words, it codes syntactically subcategorized arguments, thus it serves as a syntactic valence register. According to Alsina (1990:6), since the a-structure is sensitive to semantics, the syntactic structure of a predicate, i.e. the types and number of arguments it takes, is indirectly constrained by its semantics. However, since the semantic content of the a-structure is the minimal information about lexical semantics required by syntax, the a-structure is fundamentally a lexico-syntactic construct, not a semantic one (Bresnan 2001, Bresnan and Zaenen 1990, Zaenen and Engdahl 1994). The following schema (216) (taken from Bresnan 2001:304) summarizes the description of the a-structure outlined above.

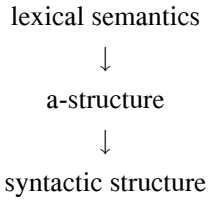
(216) *A-structure representation*

The syntactic realization of thematic roles is represented by a feature system. Lexical arguments of predicates are underspecified along the $[\pm r]$ and $[\pm o]$ features with respect to the syntactic functions to which they can be linked. This set of features cross-classifies both grammatical functions and thematic roles. According to Bresnan and Kanerva (1989), the grammatical functions SUBJ, OBJ, OBJ_θ and OBL_θ are decomposed into natural classes along the $[\pm r]$ and $[\pm o]$ features, as in Table 7.1.

	-r	+r
-o	SUBJ	OBL_θ
+o	OBJ	OBJ_θ

Table 7.1: Decomposition of grammatical functions

The semantically unrestricted $[-r]$ functions SUBJ and OBJ can be linked to arguments that bear any thematic role or can appear with no thematic role. The semantically restricted $[+r]$ functions OBJ_θ and OBL_θ are linked to arguments that bear specific semantic roles. The θ subscript is a variable for each instance of the thematic role to which these grammatical functions are restricted, for example, an OBJ_{ben} , OBJ_{instr} , OBJ_{loc} etc. depending on language specific constraints. Similarly, an OBL_θ function is also restricted in terms of the semantic roles it may bear. Such a function is overtly marked by a morphological case or a preposition which indicates its restrictedness to the semantics of that particular case or preposition. For example, an overtly expressed agent argument in a passive clause can appear as an OBL_{agent} . The $[-o]$ feature codes SUBJ and OBL_θ as non-objective functions, and the $[+o]$ feature codes both OBJ and OBJ_θ as objective functions.

Grammatical functions with the most minus features are unmarked, and those with most plus features are marked. SUBJ is the least marked function since it is specified with two minus features, $[-r]$ and $[-o]$, and the OBJ_θ is a most marked function since both its syntactic specifications, $[+r]$ and $[+o]$. This results in the

following (217) ranking of grammatical/argument functions on the basis of their relative markedness (Bresnan 2001:309).

(217) *Partial ranking of grammatical functions*

SUBJ > OBJ, OBL_θ > OBJ_θ

Furthermore, thematic roles are also cross-classified along the [$\pm r$] and [$\pm o$] features to indicate whether they are responsive to semantic restrictions in linking with grammatical functions. The feature [$\pm r$] indicates whether a semantic role has a preference in linking to a restricted grammatical function or not. The feature [$\pm o$] codes a semantic role's affinity in linking to an object-like function or not, i.e. to functions that reflect a complementation property. The notion of the [-o] feature is comparable to the external argument in GB and to the initial subject in RG, and the notion of [-r] is comparable to the internal argument in GB and initial object in RG. The assignment of syntactic features to thematic roles is determined by basic principles which are stated in (218) (Bresnan and Zaenen 1990, Bresnan 2001).

(218) *Syntactic classification of thematic roles*

Patientlike roles: [-r]

Secondary patientlike roles: [+o]

All other roles: [-o]

These principles are stated in a general manner so that they can have a wide scope of application across languages. Nevertheless, there are some studies that provide more specific principles known as the *theory of intrinsic and default classifications* depending on the particular role involved (Bresnan and Kanerva 1989, Bresnan and Moshi 1990, Alsina and Mchombo 1993). For example, the intrinsic classifications for the agent, the theme and the locative roles are stated in (219).

(219) *Intrinsic Classification of specific roles*

a. agent	b. theme and patient	c. locative
<i>ag</i>	<i>th/pt</i>	<i>loc</i>
[-o]	[-r]	[-o]

The agent then receives a [-o] syntactic classification to indicate that it cannot map to objective or object-like functions. It can be linked either to a subject function

or to an oblique or null function (i.e. with an overtly realized agent argument or unrealized agent argument in passive predicates, respectively). Since it lacks patient-like properties, it cannot initially receive the $[-r]$ classification. Even though the agent principle is valid for many languages, there are some languages which code agents in certain constructions as non-subjects. For example, agentive objects are reported to exist in Tagalog (Kroeger 1993:50) and in Norwegian (Lødrup 1999).⁷ The patient/theme semantic role can be linked to either a subject function (e.g. with passive and unaccusative predicates) or an object function (e.g. with basic transitive clauses), thus it receives the $[-r]$ syntactic classification to indicate that it must be expressed as an unrestricted grammatical function. Locative arguments must be linked to non-object functions. They usually appear as obliques (i.e. restricted to the OBL_{loc} function in many languages), but in languages that possess locative inversion constructions, they can also map to subject functions.

Alsina and Mchombo (1993) provide additional role classification principles in order to account for the applicative and dative phenomena. Applied roles receive the $[-r]$ classification when they reveal more patient-like properties than the theme arguments that co-occur with them. This classification allows applied roles to be mapped to the OBJ function. They also propose the alternative classification $[+o]$ for applied roles that reflect secondary patientlike properties, and these link to the restricted object function OBJ_{θ} . These principles are given in (220).⁸

(220) *Applied role classification* (Alsina and Mchombo 1993:26)

θ	or	θ
$[-r]$		$[+o]$

In symmetrical applicative languages more than one thematic role can reflect patient like properties, thus two of them can receive the $[-r]$ classification; however, in asymmetrical applicative languages only one of them gets the $[-r]$ classification. Bresnan and Moshi (1993) propose the Asymmetrical Object Parameter (AOP) to be stated as a condition on a-structure in order to indicate the variation in applicative constructions.

⁷Lødrup (1999) states that even though agentive objects are exceptional in world languages, such data appear to be problematic to restricted theories such as the LMT. This issue is discussed in Bresnan (1994) and Lødrup (1999).

⁸The symbol θ is used as a variable for semantic roles. Here it represents the semantic roles that can appear as applied arguments.

(221) *Asymmetrical Object Parameter* (Bresnan and Moshi 1993:75)

*	θ	...	θ
	[-r]		[-r]

The above parameter requires that only one semantic role be classified as [-r] in asymmetrical applicative languages such as Chicheŵa. On the other hand, in symmetrical languages such as Kichaga and Kinyarwanda where this restriction is lacking, the assignment of two [-r] features is possible. Bresnan and Moshi (1990) argue that symmetrical applicative languages lack the AOP. The Kichaga symmetrical applicatives that Bresnan and Moshi (1990) considered involve theme and beneficiary (i.e. ethical beneficiary, in contrast to a prototypical recipient) semantic roles, and both reveal patient-like properties. Either of the semantic roles can appear as a subject in passive clauses, and both can be marked through object affixes. However, word order distinguishes between these object arguments. The preferred word order is with the beneficiary object adjacent to the verb. Since in these languages immediate adjacency to the verb is postulated as a primary objecthood property, the applied beneficiary role is prioritized for the [-r] classification. The theme role may receive either [-r] or [+o] depending on whether it occurs in active or passive predicates. Since in active predicates the assignment of two [-r] features will violate the well-formedness condition known as the biuniqueness condition, which states that lexical roles must associate with a unique function, the theme role receives [+o] instead of [-r]. In passive predicates both semantic roles receive the [-r] classification since one of them will map to the subject and the other to the object function. As argued in Kibort (2007, 2008) this type of analysis of symmetric applicatives reflects a serious setback, since assigning the theme argument different syntactic specifications in the active and the passive may suggest that the active and the passive are represented in two different a-structures. However, the active and the passive structures differ in the way their syntactic arguments are associated with grammatical functions, rather than in their syntactic specifications. This is discussed further in Section 7.5.3.

Now that we have discussed the main components of a-structure, we will show how these are put together to compose an a-structure representation. As was stated earlier, in the standard version of LMT according to Bresnan and Kanerva (1989), Bresnan and Moshi (1990), Alsina and Mchombo (1993), Bresnan and Zaenen (1990) and Zaenen and Engdahl (1994), a-structure consists of a predicate with

- (224) a. put < x y z >
 [-o] [-r] [-o]
- b. pound < x y >
 [-o] [-r]
- c. freeze < x >
 [-r]

However, researchers such as Mohanan (1994:15), Ackerman (1990:12), Alsina (1996:37), Ackerman and Moore (2001:40) and Falk (2001:105), among others, argue against the direct representation of semantic role information at a-structure. Falk (2001:105) represents the semantic role information on a separate level designated as θ -structure, and the a-structure is represented by variables over argument positions, as in example (225).

- | | | | | | |
|-------|---------------------|--------|--------|---------------|-----------|
| (225) | θ -structure | ‘place | [agent | patient/theme | location] |
| | | | ↓ | ↓ | ↓ |
| | a-structure | | ⟨ x , | y , | z ⟩ |

Based on these proposals, Kibort (2004, 2007, 2008) proposes an extension of LMT which recognizes distinct tiers for argument positions and participant roles in a-structure, which will be presented in Section 7.5.3.

So far, the a-structure we have illustrated contains the minimal lexical information of a predicate that is necessary for the projection of semantic roles onto syntactic/grammatical functions. The a-structure is not yet associated with the final syntactic functions that a particular predicate selects in its valency or syntactic argument slots. The mechanisms for mapping the a-structure to final grammatical functions will be the topic of the following section.

7.5.2 A-structure to grammatical function mapping principles

Once the syntactically relevant information that allows the mapping of semantic roles onto grammatical functions is identified and is built up into an a-structure, linking principles are applied in order to associate the semantic roles with the most compatible grammatical functions. The basic principles for mapping a-structure

onto grammatical functions are formulated as follows (paraphrased from Bresnan (2001:311)):

- (226) a. Subject roles:
- i. $\hat{\theta}$ specified as [-o] is mapped onto SUBJ when initial in the a-structure; otherwise:
 - ii. θ specified as [-r] is mapped onto a SUBJ.
- b. Other roles are mapped onto the lowest compatible functions according to the markedness hierarchy of grammatical functions.⁹

The symbol $\hat{\theta}$ refers to the most prominent semantic role of a predicator, also designated as the 'logical subject' (Bresnan 2001:307). These linking principles appeal to the markedness property of grammatical functions portrayed in (217). The SUBJ is the least marked function, decomposed as [-o] and [-r]. Since the most prominent role with the [-o] specification corresponds to the agent role (according to the thematic role hierarchy (215) and the intrinsic classification of agent (219a), principle (226ai) determines the default mapping of the agent role to the SUBJ function (Mohan 1994:37). When this role is not available, the semantic role classified as [-r] maps onto a SUBJ by principle (226aii). The remaining roles in the a-structure map onto the lowest compatible function according to the markedness hierarchy. In this sense, the markedness hierarchy according to which these mapping principles are formulated determines the default mapping of thematic arguments to grammatical functions. The mapping principles are further constrained by two important well-formedness conditions (Bresnan 2001:311) – *the biuniqueness condition* and *the subject condition*.

(227) *The biuniqueness condition*: Each a-structure role must be associated with a unique function, and conversely.

(228) *The subject condition*: Every predicate must have a subject.

The biuniqueness condition requires that each expressed thematic role be associated with only one grammatical function, and every expressed grammatical function be associated with only one thematic role. LFG stipulates multiple restricted objects and obliques since these are further individuated by their semantic roles (Bresnan and Kanerva 1989:25). The subject condition expresses that every predicate must have a subject. In the early version of LMT, the subject condition was

⁹See 217 for markedness hierarchy.

stipulated to apply cross-linguistically. However, recent work on LMT takes the condition as a language specific constraint and dispenses with it when it deals with languages that contain subjectless constructions (Kibort 2004).

According to the mapping principles discussed above, the predicates *pound* and *freeze* will show the mapping pattern given below (229).

(229)	a.	<i>Transitive</i>	b.	<i>Intransitive</i>
		pound < agent theme >		freeze < theme >
		[-o] [-r]		[-r]
		SUBJ OBJ		SUBJ

The agent argument of the active predicate *pound* is intrinsically specified as [-o], meaning that it may associate with the non-objective functions, either the subject or the oblique functions (229a). Since it is the most prominent thematic role in the default context, it maps to the SUBJ function. According to principle (226a), the theme semantic role maps to the OBJ, since it is the next lower compatible function in the markedness hierarchy. On the other hand, the a-structure for the predicator *freeze* (229b) has a theme role with a [-r] specification as its sole argument, thus this maps to the SUBJ by principle (226aii).

The above principles determine the default mapping of thematic arguments to grammatical functions. The arguments of a predicator are partially specified for the syntactic functions they may associate with. This indicates that the same argument may associate with a different grammatical function in a morphosyntactically and/or morphologically altered predicator. In the following section we will illustrate how LMT accounts for the alternative mapping of arguments to syntactic functions reflected in the passive and the applicative constructions.

7.5.3 Alternative mappings

LMT provides lexical (redundancy) rules that explain and derive the non-default mapping of thematic arguments to grammatical functions. Lexical rules are expressed as conditions or constraints on a-structure. An important characteristic of LFG is that it represents syntax as a monotonic process, and thus there is no derivation of one structure from another as expressed by the “The Principle of Direct Syntactic Encoding” (Bresnan 2001:76). Syntactic mapping is a structure-preserving

operation, thus it can only add information, but cannot change or destroy it. LFG achieves monotonicity by removing all relation changing processes from the syntax, and by situating them in the lexicon. This is possible since argument-function mapping issues are local, and thus only affect the a-structure of the predicate. As a result, all syntactic alternations are treated as morpholexical processes. In the standard version of LMT, syntactic alternations are viewed as operations that affect the assignment of grammatical functions to semantic roles without altering the lexical semantics or the a-structure of a predicator. For example, in the active-passive alternation, the same underlying predicate argument structure is lexically associated with alternative sets of grammatical functions, as in (230).

(230) *Active-Passive alternation*

<p>a. <i>active</i></p> <table style="border: none; margin-left: 40px;"> <tr> <td style="padding-right: 10px;">pound</td> <td style="padding-right: 10px;">< agent</td> <td style="padding-right: 10px;">theme ></td> <td style="padding-right: 10px;"></td> <td style="padding-right: 10px;"></td> <td style="padding-right: 10px;"></td> </tr> <tr> <td></td> <td style="text-align: center;">[-o]</td> <td style="text-align: center;">[-r]</td> <td></td> <td></td> <td></td> </tr> <tr> <td></td> <td style="text-align: center;"> </td> <td style="text-align: center;"> </td> <td></td> <td></td> <td></td> </tr> <tr> <td></td> <td style="text-align: center;">SUBJ</td> <td style="text-align: center;">OBJ</td> <td></td> <td></td> <td></td> </tr> </table>	pound	< agent	theme >					[-o]	[-r]											SUBJ	OBJ				<p>b. <i>passive</i></p> <table style="border: none; margin-left: 40px;"> <tr> <td style="padding-right: 10px;">pound</td> <td style="padding-right: 10px;">< agent</td> <td style="padding-right: 10px;">theme ></td> <td style="padding-right: 10px;"></td> <td style="padding-right: 10px;"></td> <td style="padding-right: 10px;"></td> </tr> <tr> <td></td> <td style="text-align: center;">[-o]</td> <td style="text-align: center;">[-r]</td> <td></td> <td></td> <td></td> </tr> <tr> <td></td> <td style="text-align: center;"> </td> <td style="text-align: center;"> </td> <td></td> <td></td> <td></td> </tr> <tr> <td></td> <td style="text-align: center;">∅</td> <td style="text-align: center;">SUBJ</td> <td></td> <td></td> <td></td> </tr> </table>	pound	< agent	theme >					[-o]	[-r]											∅	SUBJ			
pound	< agent	theme >																																															
	[-o]	[-r]																																															
	SUBJ	OBJ																																															
pound	< agent	theme >																																															
	[-o]	[-r]																																															
	∅	SUBJ																																															

The passive and active a-structures contain the same semantic participants, an agent and a theme. The only difference is the way these semantic participants are mapped to grammatical functions. In the passive a-structure, as expressed in the passive lexical rule (231), the most prominent ($\hat{\theta}$) thematic role is suppressed (or is associated with a lower function), and since the argument with the [-o] syntactic specification is no longer available for mapping, the thematic role with the [-r] feature maps to the SUBJ according to the mapping principles (226) and the subject condition.

(231) *Passive lexical rule:*

$$\begin{array}{c} \hat{\theta} \\ | \\ \emptyset \end{array}$$

The symbol '∅' is used to express the notion that the most prominent argument of the predicator is suppressed in passivization. Notice that the passive rule does not express that the agent argument can also be demoted to a non-core grammatical function known as an oblique agent (OBL_{ag}). Bresnan (2001:310) indicates (in

parentheses) that the agent argument may be linked to an ‘argument adjunct’; however, she does not further specify the grammatical function category to which this argument can be assigned.

The applicative phenomenon is another central issue that has received considerable attention in the theoretical formulation of LMT. The applicative process is characterized as an operation that affects the mapping of semantic participants to grammatical functions. Bresnan and Moshi (1993:73) define the applicative rule as an operation that “adds a new theta role to the theta structure of the verb”, as schematized in (232).

(232) *Applicative lexical rule:*

$$\begin{array}{c} \emptyset \\ \Downarrow \\ \langle \theta \quad \dots \quad \theta_{appl} \quad \dots \quad \rangle \end{array}$$

The above lexical rule expresses the notion that a semantic role which initially is not subcategorized for by a base verb is introduced into the argument structure of a predicator. The θ_{appl} notation stands for all the semantic roles that an applied argument may bear such as recipient, beneficiary, goal, locative, instrumental, etc. However, Bresnan and Moshi’s characterization does not encompass the various degrees of predicate relationships that applied participants may have to base verbs. In some cases, the applicative operation can only result in remapping or rearranging an already existing semantic participant of a base verb to a different grammatical function (see chapter 4.1). In this situation, there is no new semantic role that is brought into the a-structure; rather, a core argument that in a default expression is associated with a different grammatical function, is associated with the applied object in the applicative predicate. Therefore, the applicative rule in (232) needs to be restated as in (233), so that it accurately addresses the applicative operation’s effect on the syntactic arguments, rather than the semantic participants, in the a-structure.

(233) *Revised applicative lexical rule:*

$$\begin{array}{c} \emptyset / \text{Arg}_{obl} \\ \Downarrow \\ \langle \text{Arg}_1 \quad \dots \quad \text{Arg}_{appl} \quad \dots \quad \rangle \\ [-o/-r] \quad \quad \quad [-r/+o] \end{array}$$

This lexical rule expresses that the applicative operation introduces an applied argument into the a-structure which can be syntactically classified as $[-r]$ in languages where the applied argument reveals primary patient-like properties, or as $[+o]$ in languages where the applied argument reveals secondary patient-like properties. The applicative operation either brings about a new core argument or centralizes a peripheral argument which is identified as an applied argument. This argument can link either to an OBJ or to an OBJ_θ depending on the language in question.

The applied arguments introduced by the applicative lexical rule are syntactically classified according to the specification given in (220). Applied roles such as a beneficiary or a recipient can only be classified as $[-r]$ in asymmetrical type languages such as Chicheŵa. The English dative-shifted construction is also accounted for in the same way as a beneficiary/recipient in Chicheŵa. In both languages the object functions that are associated with these roles display primary object properties with respect to word order and passivization, and in Chicheŵa also with respect to object marking, whereas the theme/patient role does not display these properties, thus is classified as $[+o]$. The pattern of linking a beneficiary role to a grammatical function in asymmetrical languages such as Chicheŵa is illustrated in (234).

(234)

pound-for	<	<i>agent</i>	<i>ben</i>	<i>theme</i>	>
		[-o]	[-r]	[+o]	
		SUBJ	OBJ	OBJ_θ	

Some languages have a reverse type of asymmetry where applied arguments bearing certain semantic roles are restricted with respect to some primary object-hood properties. In most cases, even though the applied arguments have the ability to trigger applicative marking (and/or pronominal object markers) on the verb, they may not be accessible for the subject function in passivization. For example, the applied goal/recipient argument in a double object construction with the ditransitive verb *song* 'give' in Mandarin Chinese (Huang 1993:359), the beneficiary arguments with the applied predicate *gäzi-u-la* 'he bought for her' in Tigrinya (Nazareth 2007, 2008) and the locative argument with unaccusative applicative verbs in Chicheŵa (Bresnan and Moshi 1993:83) cannot be associated with the subject function in passivization. Thus these receive the $[+o]$ classification as illustrated in (235).

(235) a. recipient/goal in Mandarin Chinese

give-to	<	<i>agent</i>	<i>theme</i>	<i>recip</i>	>
		[-o]	[-r]	[+o]	
		SUBJ	OBJ	OBJ _θ	

b. beneficiary in Tigrinya

buy-for	<	<i>agent</i>	<i>theme</i>	<i>ben</i>	>
		[-o]	[-r]	[+o]	
		SUBJ	OBJ	OBJ _θ	

c. locative in Chicheŵa

fall-in	<	<i>theme</i>	<i>loc</i>	>
		[-r]	[+o]	
		SUBJ	OBJ _θ	

In languages with symmetric applicatives the a-structure is not restricted by the AOP (221), thus both the applied argument and the theme argument can in principle receive a [-r] syntactic specification. However, assigning two [-r] specifications to semantic roles that correspond to object functions will lead to a violation of the function-argument biuniqueness condition since LFG, like RG, does not allow two identical grammatical functions to appear in the same clause (236a). Bresnan and Moshi (1990:78) propose that in beneficiary applicative constructions in Kichaga the beneficiary role is to be specified as [-r], while the theme role can be either [-r] or [+o]. In an a-structure with an active predicate the theme role receives the [+o] classification (236b). On the other hand, in an a-structure with a passive predicate the theme role is specified as [-r] and thus either of the [-r] specified roles can be mapped to the subject function since symmetric applicatives reflect alternating passive structure (236c) (Alsina 1996).

(236) a. *active applicative predicate*

eat-for	<	<i>agent</i>	<i>ben</i>	<i>theme</i>	>
		[-o]	[-r]	[-r]	
		SUBJ	OBJ	OBJ*	

b. *active applicative predicate*

eat-for	<	<i>agent</i>	<i>ben</i>	<i>theme</i>	>
		[-o]	[-r]	[+o]	
		SUBJ	OBJ	OBJ _θ	

c. *passive applicative predicate*

eat-for	<	<i>agent</i>	<i>ben</i>	<i>theme</i>	>
		[-o]	[-r]	[-r]	
		∅	SUBJ	OBJ	or
			OBJ	SUBJ	

Even though the theory proposed by Bresnan and Moshi (1990) can in principle account for typological differences between asymmetrical and symmetrical languages such as Chicheŵa and Kichaga, due to theory internal principles in LFG, the analysis of beneficiary applicatives in symmetrical languages appears to be similar to the analysis of beneficiary applicatives in asymmetrical languages. In LMT the typological differences between symmetrical and asymmetrical applicative languages is stated in terms of the AOP, which expresses that symmetrical applicative languages lack this parameter. However, in the analysis provided for Kichaga, the theme object, in spite of the primary object properties it reveals in having the ability to appear as a subject of a passive predicate and being marked by object affixes, is prevented by the well-formedness condition from getting the [-r] feature. Thus, as Kibort (2007, 2008) points out, Bresnan and Moshi's analysis requires a non-monotonic change of information which assigns a different feature for the theme semantic role in the active and the passive predicates. This is not desirable in LFG, as this framework requires a lexical rule to be a monotonic operation in that it cannot change or delete a pre-specified syntactic feature. Moreover, Kibort (2008:315) argues that the active and passive variants of predicates do not normally arise from

differences in a-structure, but rather from a difference in the association of arguments to grammatical functions. In this respect, Bresnan and Moshi's analysis appears to depart from the basic characterization of the active-passive alternation.

Kibort (2004, 2007, 2008) proposes an extension to standard LMT in order to address issues such as the mapping of semantic participants to grammatical functions in symmetrical applicatives. She proposes to separate argument positions from the representation of semantic roles based on her observation of alternative pairs of sentences in which a set of semantic roles compete for the same argument position in mapping to grammatical functions. Even though alternative expressions employ the same predicate and same number of arguments, they usually code slightly different meanings. This can only be reflected if the two components are kept distinct. Her study takes up a proposal which has been adopted by Zaenen (1993), Mohanan (1990) and Ackerman and Moore (2001), among others, to model semantic participants and syntactic arguments at different levels of representation rather than collapsing both concepts in the argument structure (237).

	x	b	y	←	<i>participant roles</i>			
(237)	give	⟨	arg ₁	arg ₂	arg ₃	⟩	←	<i>argument structure</i>
			[-o]	[-r]	[+o]		←	<i>syntactic specification</i>

In this a-structure, the variables x , y and b refer to the three key participants that reflect proto-agentive, proto-patientive and proto-beneficiary/recipient properties, respectively, as entailed by ditransitive predicates. This mapping pattern is found in English dative-shifted and Chicheŵa applicative constructions.

In addition, Kibort (2004, 2007, 2008) argues that, in the a-structure, it is not the semantic roles that should be ordered, but rather it is the syntactic representation of a predicate, which is its syntactic valency, that should remain constant. The semantic participants are allowed to change order in order to align with the argument that reflects a correct syntactic specification in a given morphosyntactic context. She assumes the following valency template to be available for a base predicate (238).

(238)	⟨	arg ₁	arg ₂	arg ₃	arg ₄	...	arg _{<i>n</i>}	⟩
		[-o/-r]	[-r]	[+o]	[-o]		[-o]	

The variables arg₁, arg₂, arg₃, etc., are placeholders for the syntactic arguments of a predicate. The argument slots are ordered from left to right according to LFG's ranking of grammatical functions based on their markedness value as shown in Table 7.1. In the model proposed by Kibort (2007), each argument slot (238) is associ-

ated with the syntactic specification of grammatical functions (i.e. the atomic values [+/- r/o]) rather than the resolved/final grammatical functions. The a-structure of an actual predicate contains only arguments selected by it as its syntactic valency. The semantic participants entailed by an applied predicate in symmetrical applicative languages correspond to two object positions, i.e. arg_2 and arg_3 specified as [-r] and [+o], respectively. The applied participant and the theme participant are allowed to map to either of the argument positions one at a time (239) (Kibort 2008:329).

(239) *Realignment of symmetric objects*

a. *Beneficiary primary*

<i>agent</i>	<i>ben</i>	<i>theme</i>
⟨ arg_1	arg_2	arg_3 ⟩
[-o]	[-r]	[+o]

b. *Theme primary*

<i>agent</i>	<i>theme</i>	<i>ben</i>
⟨ arg_1	arg_2	arg_3 ⟩
[-o]	[-r]	[+o]

Since according to the valency template (see 238) proposed by Kibort (2007) there can be only two argument slots specified as [-r], the beneficiary and the theme semantic roles cannot receive the [-r] feature at the same time. In addition, the beneficiary and the theme cannot be linked to the same argument position to assume the primary object function. In this respect, Kibort's analysis is similar to how objects in symmetrical applicatives are accounted for by standard LMT in the sense that only one semantic participant can be realized as a primary object function in a predicate. However, her representation differs from the one in standard LMT since either the beneficiary (239a) or the theme (239b) can be linked to the primary object function, although in separate a-structures. Since in symmetrical applicative languages either the applied or the theme participant can be mapped to the subject function in passive clauses, Kibort seems to suggest that the realization of the beneficiary as a passive subject results from the a-structure in (239a) and the realization of the theme as a passive subject results from the a-structure in (239b).

Even though Kibort's proposal avoids the non-monotonic change of the initially assigned $[-r]$ feature for the theme/patient role to $[+o]$ in beneficiary symmetrical applicatives, it reflects the classical problem of LMT since the two patient-like semantic participants must map to distinct object functions regardless of the similarity in the syntactic properties they reflect. LFG, like RG, attempts to resolve this problem by assuming that there are some subtle grammatical properties that distinguish between the two objects in applicative constructions, and therefore they should be linked to distinct grammatical functions.

7.6 Conclusion

In this chapter we have outlined important facets of three linguistic theories, RG, GB and LFG, which have made substantial contributions in the description and analysis of syntactic alternations such as passivization, dative alternation and applicatives. We have discussed LMT, a linking theory integrated into the LFG framework, in more detail since the theory is employed in accounting for applicative data, which is our main concern. The basic concept of a-structure is comparable to the D-structure in GB and the initial stratum in RG. It is similar to D-structure in the sense that it codes the syntactically relevant arguments of a predicate ranked according to their prominence, and it distinguishes between external ($[-o]$) and internal ($[-r]$) arguments. However, unlike D-structure, which represents θ -roles in terms of structural configuration, a-structure is an independent level of representation implemented through the constraint based architecture of LFG. In contrast to RG, the LFG a-structure acts as an interface between two independent levels of linguistic representation, the set of semantically entailed arguments of a predicate and surface grammatical functions, whereas, in RG, all levels of representation, initial, intermediate and final, model the same kind of linguistic information, i.e. grammatical relations such as SUBJ and OBJ which are considered as the only primitives of the theory. The surface grammatical relations are derivationally tracked from the representation in the initial stratum. Therefore, LMT differs from these two theories since it accounts for linguistic constructions that are conventionally known as alternations in a non-derivational manner. Consequently, it does not assume that there is meaning equivalence between the expressions that are related to each other by derivation in RG and GB.

LMT gives an adequate representation of the lexical semantics of alternation phenomena. Moreover, recent proposals have improved the theory's applicability

to a wide range of alternations. For example, the extension proposed by Kibort (2004, 2007, 2008) that separate the levels of representation for argument positions and lexical participants, allows the semantic participants to freely re-associate to argument positions given as valency slots of predicates. In this manner, it is possible to reflect the polysemy registered by alternative expressions caused by morphosemantic phenomena. However, as was discussed above, the analysis of symmetrical applicatives has some empirical consequences for the theory. LMT postulates strict categorial classes which are implemented through the assignment of binary features. As a result, semantic participants that reflect similar syntactic properties are nevertheless associated with distinct grammatical functions that are compatible with these features. For example, the semantic participant that is associated with the argument slot pre-specified as [+o] is analyzed as a restricted function even though it displays sufficient primary patient-like properties that would qualify it to map to the [-r] argument position. In the following chapter we aim to show how the feature decomposition method is problematic by confronting it with data from Tigrinya.

CHAPTER 8

Tigrinya objects and LMT

8.1 Introduction

In the previous chapter (7) we outlined how the morphosyntactic properties of applied objects are accounted for in RG, GB and LFG. We discussed how object functions are analyzed in these theories. In our discussion, we gave particular attention to LMT, the special theory in LFG that provides mapping principles and morphosyntactic rules in order to account for the argument-function patterns reflected in various constructions. The current work aims to investigate objects in constructions in Tigrinya applicatives using the basic theoretical apparatus proposed in LFG. The LFG literature identifies two types of applicative constructions: symmetrical and asymmetrical. In the symmetrical type both objects reflect morphosyntactic properties which are characteristic of a monotransitive object, whereas in the asymmetrical type only one of the objects, and most likely the applied object, assumes the morphosyntactic properties of a monotransitive object. As we noted in the previous chapter, symmetric applicatives do not get a satisfactory analysis in LMT. Even though both objects in symmetric applicatives reflect similar primary object properties with respect to the diagnostics that are widely employed to distinguish between primary and secondary objects, since LFG requires that each of the arguments in the a-structure be associated with a unique grammatical function, the two objects are assumed to be somehow distinct.

In this chapter we will confront LMT with data from Tigrinya applicatives. We

will elaborate upon the preliminary analysis of Tigrinya applicative constructions presented in Nazareth (2007, 2008). We aim to analyze how objects behave under certain grammatical diagnostics in order to determine the category of objects in Tigrinya ditransitive and applicative constructions. We will analyze applicative constructions with respect to coding strategies such as word order, case marking and pronominal indexation. In addition, we will investigate the kind of properties the different objects reflect when they are subjected to grammatical processes such as passivization and relativization.

8.2 Objecthood diagnostics

Objecthood diagnostics refer to a set of grammatical processes that are assumed to jointly reflect symmetry or asymmetry between objects. These are postulated to distinguish, on the one hand, between objects and other grammatical functions such as subjects and obliques, and on the other hand, between different types of objects. Some languages show grammatical phenomena that specifically target or prefer a certain type of object over another; however, as Andrews (1985:120) points out, since there are fewer grammatical processes that distinguish between subtypes of objects than there are processes distinguishing objects from subjects, it is difficult to tell whether the variation in the coding features of object-like NPs reflects differences in their grammatical relations. In addition, grammatical processes that can reliably distinguish between different types of objects in one language may not be equally significant in another language.

In chapter 7 we pointed out that most of the standard objecthood tests were established by Chung (1976:42) in her analysis of benefactive applied objects in Bahasa Indonesia. She argues that direct objects can be distinguished from indirect objects by certain syntactic operations that specifically earmark them. The syntactic processes identified by her include the ability of appearing as a bare (prepositionless) NP, becoming the subject in passivization, and being coreferential with the subject in reflexivization, and being preposed, extracted and relativized. In addition to these, Bresnan and Moshi (1990) identify diagnostics such as immediate adjacency with the verb, controlling verbal affixation, deletion of unspecified objects and reciprocalization as primary objecthood tests. Bresnan and Moshi assume that these diagnostics are the basis for a single parameter of variation to explain the typological split between symmetric and asymmetric applicatives in Bantu. In symmetric applicatives two objects possess these properties, while in asymmetric

applicatives only one object has these properties.

In LMT the object that displays a significant proportion of these properties is assigned the syntactic feature [-r] and the object that does not show these properties is assigned the feature [+o]. Supporting this proposal, Alsina (1996:674) terms the formulations of these studies the *theory of object asymmetries*, and argues that the underlying properties of objects are responsible for primary objecthood. Moreover, he claims that the type of passive found in a language correlates with independently observable coding behaviors such as object pronominal markers and word order. That is to say, the arguments that correspond to objects that control verbal affixes and appear immediately adjacent to the verb also have the ability to appear as subjects in passive clauses. Diagnostics such as these have been applied as standard tests of object symmetry/asymmetry in many languages within different frameworks.

In the following sections, we will investigate object categories in Tigrinya with respect to coding strategies such as word order, case and pronominal marking. We will consider different verbs since applied objects tend to behave differently depending on the type of verb they appear with. In addition, we are going to investigate how objects respond to grammatical processes such as passivization, relativization and clefting.

8.2.1 Word order, case marking and pronominal affixes

Tigrinya uses a complex interplay of word order, case and verbal affixes to code grammatical functions. A basic discussion of Tigrinya clause structure is given in chapter 2.5. Here we aim to investigate the word order, case marking and pronominal affixes that characterize objects in double object and applicative constructions. Let us begin by reviewing how objects are coded in monotransitive clauses. Example (240), repeated from (63), exhibits the basic word order, SOV, that codes a pragmatically neutral reading of the clause.

- (240) a. ብዕራይ ላም ርኻዩ ።
 biʕray lam riʔy-u
 bull.MSg cow.FSg PerfS.see-SM.3MSg
 ‘A bull saw a cow.’
- b. *ላም ብዕራይ ርኻዩ ።
 lam biʕray riʔy-u
 cow.FSg bull.MSg PerfS.see-SM.3MSg

- c. እቲ ብዕራይ ነታ ላም
 ʔit-i biʔray n-äta lam
 Det-3MSg bull.MSg Obj-Det.3FSg cow.FSg
ርእዩዎ ።
 riʔy-u-wa
 PerfS.see-SM.3MSg-OM₁.3FSg
 ‘The bull saw the cow.’
- d. ነታ ላም እቲ ብዕራይ
 n-äta lam ʔit-i biʔray
 Obj-Det.3FSg cow.FSg Det-3MSg bull.MSg
ርእዩዎ ።
 riʔy-u-wa
 PerfS.see-SM.3MSg-OM₁.3FSg
 ‘The bull saw the cow.’

As illustrated by (240a), subjects are unmarked for case and the verb obligatorily agrees with its subject. Like the subject, indefinite objects are also unmarked for case, and they cannot be cross-referenced on the verb with object suffixes. When objects do not bear any case marking that distinguishes them from subjects, they obligatorily occur in a fixed position. As example (240b) shows, switching their order results in an ungrammatical clause. On the other hand, definite objects are case marked and are cross-referenced on the verb with the object pronominal suffix, as in (240c). Objects that are distinctly marked by case marking and pronominal suffixes can be alternatively reordered in order to render various pragmatic readings such as contrastive focus, contrastive topic and topicalization. For example, cross-referenced objects can be topicalized by fronting them, as in (240d).

In Tigrinya, object markers are admitted on the condition of definiteness. A verb bears a pronominal object marker either for an object that it is initially subcategorized for, or for an object that is admitted through object verb suffixes, and in both cases, the objects must be definite. Therefore, the object markers are associated with individuated or salient objects in a discourse context. In multiple object constructions, there is a tendency for the object with the recipient/beneficiary role to be prioritized for pronominal marking, since these objects usually tend to be associated with individuated human referents (Hopper and Thompson 1980). However, there is also a possibility for a non-recipient object with a higher discourse prominence to be selected for pronominal marking over a human argument (Dalrymple and Nikolaeva 2007). This is a situation we observe in clauses with prototypical ditransitive verbs in Tigrinya. As was discussed in chapter 5.3.2, objects reflect properties which are quintessential for the class of verbs that are subcategorized for them. For example, objects of prototypical ditransitive verbs do not behave in

the same way as applied objects of basic transitive verbs. Therefore, we will consider examples from various classes of verbs.

Recipient objects in ditransitive constructions

A prototypical ditransitive clause involves a subject which bears an agent role, an object with a recipient role and another object with a theme role (refer to section 4.4.1 for a detailed description of these constructions). Commonly, the recipient argument tends to be realized as a definite object and the theme argument as an indefinite object. An indefinite theme object cannot bear the objective case marker, not can it be co-referenced with a verbal suffix (see section 2.5). On the other hand, the noun phrase that is associated with the recipient argument bears the objective case marker *nī-* regardless of whether the argument has indefinite or definite referents, but only definite recipient arguments can be indexed on the verb with OM_1 . We should also note that a definite object in a monotransitive clause and a definite object in a ditransitive clause are coded with the same suffix type. Example (241) illustrates a double object ditransitive clause.

- (241) አቲ ሓረስታይ ነተን ከብቲ ሳዕሪ
 ?it-i ḥarästay n-ät-än käbti saʕri
 Det-3MSg farmer.Sg Obj-Det-3FPI cattle grass
 ሂቡወን።
 hib-u-wän
 PerfS.give-SM.3MSg- OM_1 .3FPI
 ‘The farmer gave the cattle grass.’

This word order can be identified as the unmarked or neutral word order since none of the constituents bear special emphasis or stress. Moreover, this order reflects the discourse hierarchy of grammatical functions since discourse functions such as topic and focus are syntactically encoded. In the neutral word order, grammatical functions are ordered according to their decreasing discourse topicality. A subject that corresponds with specific and referential arguments occurs at the default topic position, which is the initial position in the clause. This is followed by a definite recipient object, and an indefinite theme object is ordered last, i.e. between the recipient and the verb.

In addition, the language allows various permutations of the default word order to encode variation in information structure. Switching the positions of the two objects does not affect the grammaticality of the sentence (Raz 1980, Weldu 2004); however, it changes the information structure of the clause. For example, the theme object in (242) assumes a contrastive focus reading.

- (242) እቲ ሓረስታይ ሳዕሪ ነተን ከብቲ
 ?it-i ḥarästay saʕri n-ät-än käbti
 Det-3MSg farmer.Sg grass Obj-Det-3FPI cattle
ሂቡዎን ።
 hib-u-wän
 PerfS.give-SM.3MSg-OM₁.3FPI
 ‘The farmer gave the cattle grass.’

As long as the two objects are coded differently in terms of case marking, they can appear in any order with respect to each other. In both examples (241) and (242) the object bearing a recipient semantic role is marked with the objective case, whereas the object bearing the theme role is unmarked. Consequently, the verb carries an object pronominal suffix for the recipient object. This differential coding strategy helps to distinguish between the theme and the recipient objects.¹ Fronting the indefinite theme object brings about a difference in information structure roles. The NP that corresponds with the theme object is pronounced with a pitch accent and is set apart from the other segments by a boundary tone. The contrastive reading suggests that there is a contextually salient set of alternatives other than grass that the hearer may think that the cattle could have been given as food. Thus, the speaker stresses that it was ‘grass’, and not something else, that the farmer gave to the cattle.

Another word order possibility is one in which the definite recipient object is placed clause initially in order to explicitly foreground it, thus giving it the status of an emphatic or marked topic, as in (243).

- (243) ነተን ከብቲ እቲ ሓረስታይ ሳዕሪ
 n-ät-än käbti ?it-i ḥarästay saʕri
 Obj-Det-3FPI cattle Det-3MSg farmer.Sg grass
ሂቡዎን ።
 hib-u-wän
 PerfS.give-SM.3MSg-OM₁.3FPI
 ‘The cattle, the farmer gave them grass.’

Fronting of definite objects marks a change in the default discourse topic. Normally, it is the subject which is the most topic-worthy element, and thus it assumes the primary topic function in the unmarked clause or in the default ordering of discourse functions. However, in this clause, it is the recipient object that is syntactically marked as the highly topical element. The postposed subject assumes a contrastive topic reading which may be paraphrased as ‘it is the farmer, not somebody else, that gave grass to the cattle’.

¹Raz (1980) identifies similar word order patterns in Tigre, an Abyssinian Semitic language closely related to Tigrinya. In this language, the two objects are not ordered in relation to each other.

However, the relative word order freedom becomes fixed under certain morphological coding circumstances. Such a situation is known as ‘word order freezing’, and has been observed in languages such as Hindi and Korean (Mohanani 1992, 1990, Lee 2001, 2003), among others. Freezing refers to an exceptional enforcement of fixed word order in free word order languages, and it typically occurs when grammatical elements lack morphological markers to distinguish their function or their category (e.g. the order of a definite subject and an indefinite object in a Tigrinya monotransitive clause), or when they are identically marked as is the case of the two objects in a ditransitive clause. In Tigrinya the ordering of the two objects becomes fixed in the presence of a definite theme object. In this situation both objects are marked with the objective case, thus the theme object obligatorily precedes the recipient object, as in (244).

- (244) a. እቲ ሓረስታይ ነቲ ሳዕሪ ነተን ከብቲ
 ?it-i ḥarästay n-ät-i saʕri n-ät-än käbiti
 Det-3MSg farmer.Sg Obj-Det-3MSg grass Obj-Det-3FPI cattle
 ሂቡዎን ።
 hib-u-wän
 PerfS.give-SM.3MSg-OM₁.3FPI
 ‘The farmer gave the cattle the grass.’
- b. ?እቲ ሓረስታይ ነተን ከብቲ ነቲ ሳዕሪ
 ?it-i ḥarästay n-ät-än käbiti n-ät-i saʕri
 Det-3MSg farmer.Sg Obj-Det-3FPI cattle Obj-Det-3MSg grass
 ሂቡዎን ።
 hib-u-wän
 PerfS.give-SM.3MSg-OM₁.3FPI
 ‘The farmer gave the cattle to the grass.’
- c. እቲ ሓረስታይ ነቲ ሳዕሪ ነተን ከብቲ
 ?it-i ḥarästay n-ät-i saʕri n-ät-än käbiti
 Det-3MSg farmer.Sg Obj-Det-3MSg grass Obj-Det-3FPI cattle.Pl
 ሂቡዎ ።
 hib-u-wo
 PerfS.give-SM.3MSg-OM₁.3MSg
 ‘The farmer gave the grass to the cattle.’

The example in (244a) shows the fixed order of a definite base object and a recipient object. Switching the order of the objects as in (244b) does not make the sentence ungrammatical, but it can make it sound pragmatically strange. In this reversed order, the grass is understood as the recipient and the cattle as the theme argument, a meaning which may be acceptable in a fairytale world. In these examples, both objects possess high topic-worthiness, therefore both have a potential to be coded with a pronominal suffix. Thus, the object that the interlocutor wants to

emphasize is expressed with pronominal suffixes and codes higher discourse topicality. Example (244c) codes the theme object as the most topical object. In cases where both the theme and the recipient object reflect the same agreement values, the verbal suffix becomes ambiguous and does not clearly identify which object is being coded. Therefore, with respect to pronominal marking, the objects display symmetric properties.

The ‘freezing’ situation is also observed in a ditransitive clause that codes a definite theme object and an indefinite recipient object. Similar to the previous examples, in this situation both objects are marked also with the objective case, but only the theme object possesses the topic-worthiness necessary in order to be cross-referenced on the verb. As example (245) shows, in this pattern the theme object must precede the recipient object, and is marked on the verb.

- (245) እቲ ሃብታም ንኹሉ ገንዘብ ንድኻታት
 ?it-i habtam ni-kul-u gänzäb-u ni-dika-tat
 Det-3MSg rich.Sg Obj-all.M money-Poss.3MSg Obj-poor-Pl
 ሂቡዎ።
 hib-u-wo
 PerfS.give-SM.3MSg-OM₁.3MSg
 ‘The rich person gave all his money to poor people.’

However, in a ditransitive clause where neither of the objects is definite, the order of the two objects becomes flexible, similar to the situation observed in example (242). Both orders, i.e. recipient object > theme object and theme object > recipient object, are possible and code the same meaning with differing information structure role. Word order variation is possible because the indefinite theme is unmarked for case, whereas the recipient is marked for case, as in (246).

- (246) a. መንግስቲ ወርሒ ወርሒ ንድኻታት ስድራቤታት ገንዘብ
 mängisti wärhi wärhi ni-dika-tat sidrabet-tat gänzäb
 government month month Obj-poor-Pl family-Pl money
 ይህብ።
 yi-hib
 Imperf3-give.SM.MSg
 ‘Every month the government gives money to poor families.’
- b. መንግስቲ ወርሒ ወርሒ ገንዘብ ንድኻታት ስድራቤታት
 mängisti wärhi wärhi gänzäb ni-dika-tat sidrabet-tat
 government month month money Obj-poor-Pl family-Pl
 ይህብ።
 yi-hib
 Imperf3-give.SM.MSg
 ‘Every month the government gives (to) poor families money.’

In (246a), the recipient object precedes the theme object. This is a discourse neutral structure in which grammatical functions are ordered according to their topic prominence from left to right. The recipient argument is ordered higher than the theme since it is typically associated with animate referents, and thus has higher topic-worthiness than the indefinite theme. In (246b), the theme object is pre-posed before the recipient, and this position codes a contrastive focus reading of the theme object.

Based on these observations, we can conclude that the various ordering possibilities in Tigrinya indicate that there is no verb–adjacency requirement that structurally binds either of the objects. In this situation, Tigrinya codes symmetric objects that can occur equally well in either position, without affecting the grammaticality of ditransitive clauses. Since the two objects are marked differently in terms of case, they can be easily identified when they are placed in different discourse marked positions in order to express various information structure. However, there is an exception to this which we have described as ‘freezing’ where identically coded objects are distinguished by a fixed word order. In this situation even though the recipient is restricted to occur before the verb, that does not guarantee it a primary object status since both objects have equal access to pronominal suffixes.

With regard to word order restrictions in ditransitive clauses, the two objects may appear symmetric, since they can be coded in either position. Nevertheless, since in Tigrinya immediate verb adjacency is not posited as a constraint for primary object coding, then word order may not be used as a strong argument to determine the symmetric properties of these objects. Even so, since both objects can be pronominally marked depending on their definiteness value, both objects demonstrate primary object properties simultaneously.

In terms of case marking, the prepositional marker *ni-* is used to code objects that bear various semantic relations and that may have different syntactic functions. It is used as a case marker for definite core objects that bear a theme or recipient role. It can also be interpreted as a semantically restricted preposition to express the recipient argument reading regardless of whether it is definite or not. This may suggest that when the recipient argument is expressed as an indefinite object, and thus is not cross-referenced on the verb, it may be considered to have an oblique function. However, since definite recipient arguments, similar to theme arguments, trigger verbal marking, this casts doubt on their obliqueness since pronominal marking is considered as a property of core grammatical functions. In contrast, other semantic relations such as the locative and the instrumental possess distinct prepositions

that mark their oblique function, and they are identified with a *ni-* prepositional marker only when they function as core objects. Moreover, since with respect to case and pronominal marking, a definite recipient object is very similar to a definite theme object, we assume that recipients are semantically required arguments of the verb. Recipient objects reflect morphosyntactic properties which are similar to those reflected by theme objects in monotransitive clauses. As we will see later (section 8.2.2), grammatical tests such as passivization also confirm the functional symmetry of these objects in prototypical ditransitive constructions in Tigrinya.

Objects in applicatives with transitive bases

In double object applicative constructions, beneficiary, locative and instrumental objects reveal significant differences from recipient objects with respect to their coding properties. In general, objects in double object clauses reflect similar word order patterns when they are not specially marked or emphasized. In the neutral order, when recipient, beneficiary/maleficiary, locative and instrumental objects co-occur with indefinite theme objects, they appear in this order: $SUBJ > OBJ_{recip/ben/loc/instr} > OBJ_{theme} > V$, and the object pronominal suffix corresponds with the recip/ben/loc/instr object. However, double object clauses that code definite theme objects reflect different constraints, depending on the semantic role reading of the applied objects. They also differ in the constraints they adhere to in admitting object pronominal suffixes. As was discussed earlier in chapter (4.3), an applied object with a beneficiary, a maleficiary, a goal, a source, a locative or an instrumental semantic role is marked with a different verbal suffix (OM_2) than the one employed for recipient and theme objects (OM_1). The verb obligatorily bears the suffix OM_2 for objects that bear applied semantic roles. However, the verbal suffix OM_1 can mark either the recipient or the theme object depending on the discourse reading the speaker intends to express. In the following section we will analyze the asymmetric properties of objects with respect to word order, pronominal suffixes and case marking in beneficiary, locative and instrumental applicative constructions. Let us first consider the beneficiary applicative constructions in (247).

- (247) a. የኖስ ንሓጢ ንጋዜን ሃዲኑ-ሉ ።
 Yonas ni-ḥaww-u ḥagazen hadin-u-lu
 Yonas.M Obj-brother-Poss.3MSg deer.Sg PerfS.hunt-SM.3MSg- OM_2 .3MSg
 ‘Yonas hunted his brother a deer.’

- b. የኖስ ዓጋዜን ንሐጢ ሃዲኑ-ሉ ።
 Yonas ሿagazen ni-ḥaww-u hadin-u-lu
 Yonas.M deer.Sg Obj-brother-Poss.3MSg PerfS.hunt-SM.3MSg-OM₂.3MS
 ‘Yonas hunted his brother a deer.’

As with recipient objects, applied beneficiary objects come before indefinite theme objects in a discourse neutral clause (247a). The applied object NP is marked with the objective case *ni-*, whereas the indefinite theme object is not marked for case. The verb obligatorily bears the applicative suffix OM₂ for the beneficiary argument. Example (247b) illustrates that the order of the beneficiary and theme objects can also be switched in order to code a different information structure. In this structure, the theme object expresses a contrastive focus reading. Therefore, as with ditransitive double object constructions, there is no structurally implied position that code a primary and secondary objects in double object constructions with beneficiary applied objects.

The double object clause with a beneficiary object does not reflect the word order freezing situation which is observed in ditransitive clauses with the co-occurrence of two definite objects. Examples (248a) and (248b) show that the two objects can switch order even though they bear the same case marking.

- (248) a. የኖስ ነታ ዓጋዜን ንሐጢ
 Yonas n-ät-a ሿagazen ni-ḥaww-u
 Yonas.M Obj-Det.3FSg deer.Sg Obj-brother-Poss.3MSg
 ሃዲኑ-ሉ ።
 hadin-u-lu
 PerfS.hunt-SM.3MSg-OM₂.3MSg
 ‘Yonas hunted the deer for his brother.’
- b. የኖስ ንሐጢ ነታ ዓጋዜን
 Yonas ni-ḥaww-u n-ät-a ሿagazen
 Yonas.M Obj-brother-Poss.3MSg Obj-Det.3FSg deer.Sg
 ሃዲኑ-ሉ ።
 hadin-u-lu
 PerfS.hunt-SM.3MSg-OM₂.3MSg
 ‘Yonas hunted the deer for his brother.’
- c. የኖስ ነታ ሰበይቲ ንሳባ
 Yonas n-ät-a säbäyti ni-Saba
 Yonas.M Obj-Det.3FSg woman.Sg Obj-Saba.F
 ሒሁ-ላ ።
 ḥiz-u-la
 PerfS.seize-SM.3MSg-OM₂.3FSg
 ‘Yonas seized the woman for Saba./ Yonas seized Saba for the woman.’

It is possible to switch the order of the two objects because these objects require different forms of pronominal markers, and the one which appears on the applied verb will always cross-reference with the beneficiary object, thus the verbal suffix will not ambiguously code the theme object. In addition, when the theme and the beneficiary objects code different gender agreement values, they can switch order, since the object whose agreement value matches that of the applied verb will be resolved as the beneficiary object. However, since the word order is not fixed, when the clause codes two objects with identical agreement values, either of the referents can be understood as a beneficiary argument, as in (248c). Thus, in this situation only the discourse context can decipher the role played by each referent.

The various ordering options code varying information structure readings. As we have seen before, the focus element canonically occurs in the immediate preverbal position in Tigrinya. In (248a) thus, the applied beneficiary assumes a focus discourse function, whereas in (248b) it is the theme object that has this function. These utterances are appropriate in different discourse contexts. Lambrecht (1998:282) suggests that *wh*-questions, which he also designates as information questions, can be used to identify the information structure of a clause when the open proposition that results from removing the question expression from a sentence is pragmatically presupposed in the discourse. For example, the utterance with a focused beneficiary (248a) can arise as a reply to the question in (249a), and the utterance with a focused theme (248b) can arise as a reply to the question in (249b).

- (249) a. **ዮናስ ነታ ሳገረን ንመን ሃዲኑሉ ፡**
 Yonas n-ät-a ሳገረን ni-män hadin-u-lu
 Yonas.M Obj-Det.3FSg deer.Sg Obj-who PerfS.hunt-SM.3MSg-OM₂.3MSg
 ‘Who did Yonas hunt the deer for?’
- b. **ዮናስ ንሓዉ እንታይ ሃዲኑሉ ፡**
 Yonas ni-ḥaww-u ንታይ ሃዲኑሉ
 Yonas.M Obj-brother-Poss.3MSg what PerfS.hunt-SM.3MSg-OM₂.3MSg
 ‘What did Yonas hunt for his brother?’

The question words *ni-män* ‘to whom’ and *ንታይ* ‘what’ are replaced by the beneficiary object *ni-ḥaww-u* ‘for his brother’ (249a) and the theme object *nä-ta ሳገረን* ‘the deer’ (248a), respectively. The speaker assumes that the addressee can identify the deer, and also assumes that the addressee knows that Yonas has a brother. Consequently, since the brother and deer are already established as topics in the question clauses, they appear as old information in the respective response clauses, (248a) and (248b). These question words appear in the default focus position in a neutral question clause. In this position the information represented by the question

word is not emphasized or pragmatically marked. The question word in (249a) bears the objective case marker *ni-* since this form is used to request information about object referents.² The verb can bear the suffix OM₂ for the beneficiary argument whether the questioned entity is a beneficiary (249a) or a theme (249b). The fact that the verb can bear an object suffix for a beneficiary in a clause that questions it, indicates that the OM₂ can also correspond to a focus element. In contrast, the verb cannot bear a pronominal suffix for a questioned theme object, as in (250).

- (250) የኖስ ነሐው እንታይ
 Yonas ni-ḥaww-u ?intay
 Yonas.M Obj-brother-Poss.3MSg what
 ሃዲኑ*ዎ/*ዋ፣
 hadin-u-**wo/*wa*
 PerfS.hunt-SM.3MSg-**OM₁.3MSg/3FSg*
 ‘What did Yonas hunt for his brother?’

The question word *?intay* ‘what’ questions the identity of the referent of the theme object which is new information in the discourse. However, in a clause where the questioned object is a beneficiary, the verb can bear the suffix OM₁ for a definite theme object, as in (251).

- (251) የኖስ ነታ ዓጋዜን ንመን (ኢሉ)
 Yonas n-ät-a ḡagazen ni-män (?il-u)
 Yonas.M Obj-Det.3FSg deer.Sg Obj-who (PerfS.intending-SM.3MSg)
 ሃዲኑዋ፣
 hadin-u-wa
 PerfS.hunt-SM.3MSg-OM₁.3MSg/3FSg
 ‘(Intending) for whom did Yonas buy the deer?’

Moreover, the question word referring to the beneficiary object can be optionally embedded under an adjunct clause headed by the light verb *?il-u* ‘intending/thinking’ to express a *purposive* reading (see section 6.3.2 for more discussion). This purposive clause is also known as a converb construction which expresses a gerundive reading without being marked overtly with a conjunctive to indicate its dependency. The fact that the question word referring to the beneficiary can be embedded under the purposive converb clause indicates that it has an adjunct function. The sentence that can be evoked as a reply to the question in (251) reflects similar information structure the question clause, as can be seen in (252). When the verb bears an object suffix for the theme argument, the theme object is topical; therefore, the nominal that corresponds the beneficiary argument is constrained to appear af-

²The content question word used for subjects, i.e. *män* ‘who’, is unmarked for case.

ter it. Similar to a beneficiary question word, the nominal that codes the beneficiary object can also be optionally embedded under a converb adjunct clause.

- (252) a. **ዮናስ ነታ ናጋዜን ንሓፊ.**
 Yonas n-ät-a ፤agazen ni-ḥaww-u
 Yonas.M Obj-Det.3FSg deer.Sg Obj-brother-Poss.3MSg
(ኢሉ) ሃዲኑዋ ።
 (ʔil-u) hadin-u-wa
 (PerfS.intending-SM.3MSg) PerfS.hunt-SM.3MSg-OM₁.3FSg
 ‘Yonas hunted the deer for his brother.’
- b. ***ዮናስ ንሓፊ ነታ ናጋዜን**
 Yonas ni-ḥaww-u n-ät-a ፤agazen
 Yonas.M Obj-brother-Poss.3MSg Obj-Det.3FSg deer.Sg
ሃዲኑዋ ።
 hadin-u-wa
 PerfS.hunt-SM.3MSg-OM₁.3FSg
 ‘*Yonas hunted the deer to his brother (3FSg agreement with recipient).’
- c. **ዮናስ ንሓፊ ኢሉ ነታ**
 Yonas ni-ḥaww-u ʔil-u n-ät-a
 Yonas.M Obj-brother-Poss.3MSg PerfS.intending-SM.3MSg Obj-Det.3FSg
ናጋዜን ሃዲኑዋ ።
 ፤agazen hadin-u-wa
 deer.Sg PerfS.hunt-SM.3MSg-OM₁.3FSg
 ‘Yonas hunted the deer (, intending it) for his brother.’

Placing a beneficiary that is not controlled by the verb before a definite theme object results in an ungrammatical clause, as in (252b). However, moving an embedded beneficiary from the focus position does not bring about the same effect, as is shown in (252c). In (252b), since the beneficiary and the theme are coded identically in terms of case, they are constrained to appear in a determined position. However, as example (252c) shows, the beneficiary can move from its canonical focus position only when it is embedded under the converb clause, and in this structure it cannot be confused with the theme object. This test shows that the beneficiary has an adjunct function when the theme object controls the object pronominal suffix.

In contrast, embedding the beneficiary argument in a converb clause when the verb bears a suffix for it results in an ungrammatical expression (253), therefore the adjunct expression is ungrammatical when the beneficiary is controlled by the verb.

- (253) የዮናስ ነታ ዓጋዜን ንሐፊ
 Yonas n-ät-a ሿagazen ni-ḥaww-u
 Yonas.M Obj-Det.3FSg deer.Sg Obj-brother-Poss.3MSg
 (*ኢሉ) ሃዲኑሉ ።
 (*ʔil-u) hadin-u-lu
 (*PerfS.intending-SM.3MSg) PerfS.hunt-SM.3MSg-OM₂.3MSg
 ‘Yonas hunted his brother the deer (*intending it for him).’

When the beneficiary is indexed on the verb, it has a core object status, and thus it cannot be embedded in an adjunct converb clause.

The verb *hadänä* ‘he hunted’ is not lexically subcategorized for a beneficiary argument, thus the beneficiary argument cannot be associated with a core object function when the verb does not bear the appropriate applicative suffix for it. Therefore, we assume that the NP that is associated with the beneficiary argument in (252a) has an adjunct function. Since the beneficiary, like the recipient argument, can be marked with the preposition *ni-* whether it is expressed as applied object or not, we cannot determine from the case marker alone whether it has a core object or an oblique/adjunct function. Therefore, the obliqueness of the beneficiary can be made explicit by embedding it under the purposive/beneficiary light verb *ʔil-u* ‘he thought/intended’. This test seems to make a clear distinction between a core and an oblique/adjunct expression of the beneficiary. As example (252a) shows, the expression of the beneficiary argument forms a constituent of the embedded small clause headed by the converb. Expressing the beneficiary as an adjunct under a converb makes its meaning more apparent and determined. In contrast, as can be observed from example (253), the beneficiary applied object cannot be embedded in a dependent clause headed by a converb.

To sum up, the beneficiary argument is coded as a core object when the verb bears the suffix OM₂ for it. In this structure, the beneficiary object is case marked with the objective case *ni-*. When the verb is not marked as an applied verb, the marker *ni-* is employed as a preposition to mark the semantic relation of the beneficiary role in an oblique expression. In the beneficiary applicative construction, there is no verb adjacency requirement that implicates one of the involved objects as a primary object since either of the objects can occur in the preverbal position. However, on the basis of object marking, the beneficiary applied object can be eligible for the primary object function, since it is obligatorily marked on the verb. Before coming to a definitive conclusion however, we will analyze its behavior with regard to other grammatical tests such as passivization, a task which will be undertaken later. In the remainder of this section we will analyze object properties

of locative and instrumental applied objects with respect to word order, case and pronominal marking.

The basic word order of constituents in locative and instrumental applicative constructions adheres to the basic word order observed in the double object constructions that we have discussed previously. Typically, the locative, as in (254a and 254b), or the instrumental applied object, as in (254c) and (254d), occurs before the theme object in a pragmatically neutral expression. The locative and instrumental applied objects appear in the default topic position and the theme object in the default focus position. The referents of the applied objects are definite and individuated. The examples in (254) illustrate this pattern.

- (254) a. እቲ መምህር ነቲ ሰደቓ መጽሓፍ
 ?it-i mämhir n-ät-i sedeqa mäṣḥaf
 Det-3MSg teacher.Sg Obj-Det-3MSg desk.Sg book.Sg
 ኣንቢሩሉ።
 ?anbir-u-lu
 PerfS.put-SM.3MSg-OM₂.3MSg
 ‘The teacher put a book on the desk.’
- b. እቲ ኣረሰታይ ነታ በዓቲ እኽሊ
 ?it-i ḥarästay n-ät-a bä?ati ?ikli
 Det-3MSg farmer.Sg Obj-Det-3FSg cave.Sg grain
 ኣቢኡላ።
 ḥabi?-u-la
 PerfS.hide-SM.3MSg-OM₂.3FSg
 ‘The farmer hid some grain in the cave.’
- c. እቲ ኣረሰታይ ነቲ ማሕረሻ ግራቱ
 ?it-i ḥarästay n-ät-i mahreša girat-u
 Det-3MSs farmer.Sg Obj-Det-3MSg plough land-Poss.3MSg
 ኣረሰሉ።
 ḥaris-u-lu
 PerfS.plough-SM.3MSg-OM₂.3MSg
 ‘The farmer ploughs his land with the plough.’
- d. እቲ ሰብኣይ ነቲ ፋስ ዕንጨይቲ
 ?iti säb?ay n-ät-i fas ?inčäyti
 Det.3MSg man.Sg Obj-Det.3MSg ax.Sg wood.Sg
 ፈሊጹሉ።
 fäliṣ-u-lu
 PerfS.chop-SM.3MSg-OM₂.3MSg
 ‘The man chopped wood with the ax.’

The verb is obligatorily marked with the suffix OM₂. Consequently, it cannot alternatively code the theme object, since this would result in a non-applicative expression of the locative and the instrumental arguments. The nominals that code these

applied semantic roles are marked by the objective case *ni-*, but the oblique expressions are coded by different prepositions that distinctly express the locative and the instrumental semantic relations. The applicative and the oblique expressions code different discourse construals, as we can see from the conversation in (255).

- (255) a. ኣብ'ቲ ጣውላ ኮይና ከንሰርሕ
 ?ab'ti tawla koyyi-na ki-n-säriḥ
 Loc'Det.3MSg table.Sg PerfS.be-1Pl Purp-Imper1-work.SM.PI
 ኣይንኸእልን ኢና #
 ?ay-ni-ki?li-n ?i-na
 Neg-Imper1-be=able.SM.PI-Neg Pers.be-SM.1Pl
 'We cannot work on the table. Lit. we cannot work being on the table.'
- b. ንምንታይ፡
 ni-mintay
 for-what
 'Why?'
- c. ምኸንያቱ፡ ሳባ ምሳሕ ቀሪባትሉ
 miḵniyatu Saba misaḥ qärib-a-tlu
 because Saba.F lunch PerfS.prepare-SM.3FSG-OM₂.3MSg
 ኣላ #
 ?all-a
 Pres.be=loc-SM.3FSG
 'Because Saba has prepared lunch on it.'

In the clause that opens the discourse the speaker uses an oblique phrase to express the locative argument (255a), whereas replying to the question in (255b) the speaker employs an applicative expression (255c). In (255c), the whole clause presents new information. The subject and the theme object are obligatory, but the expression of the applied object is dropped since it is obvious from the previous discourse. This sentence is elicited when the speaker reports an event that the listener has not heard about before; however, the speaker assumes that the listener can identify the referents of the subject and the applied object. The applied object is given as old information, and thus does not overtly appear in the clause, but the subject Saba and the theme object lunch are given new information, foci, in (255c).

Moreover, the fact that applied objects with locative and instrumental roles cannot be focused through a content question word, i.e. such as *where*, demonstrates that these applied objects tend to appear as discourse topics. Content question words that target information about a location and an instrument are marked with prepositions that express the semantic relations, as in (256) and (258), and in the response clauses these semantic relations appear as oblique expressions, as in (257a) and (259a).

- (256) እቲ መምህር ነቲ መጽሓፍ ኣበይ/ኣብ ምንታይ
 ?it-i mämhir n-ät-i mäṣḥaf ?abäy/?ab mintay
 Det-3MSg teacher.Sg Obj-Det-3MSg book.Sg where/on what
 ኣንቢሩዎ፡
 ?anbir-u-wo
 PerfS.put-SM.3MSg-OM₁.3MSg
 ‘The teacher, where (on what) did he put the book?’
- (257) a. ኣብ ሰደቓ (ኣንቢሩዎ)።
 ?ab sedeqä ?anbir-u-wo
 on desk.Sg PerfS.place-SM.3MSg-OM₁.3MSg
 ‘He put it on a desk.’
 b. *ነቲ ሰደቓ ኣንቢሩሉ።
 n-ät-i sedeqä ?anbir-u-lu
 Det-3MSg desk.Sg PerfS.put-SM.3MSg-OM₂.3MSg
 ‘On the table he put it.’
- (258) እቲ ሰብኣይ ዕንጭይቲ ብምንታይ ፈሊጹ፡
 ?iti säb?ay ?iničäyiti bi-mintay fäliṣ-u
 Det.3MSg man.Sg wood.Sg Instr-what PerfS.chop-SM.3MSg
 ‘The man, with what did he chop wood?’
- (259) a. ብቲ ፋስ (ፈሊጹ)።
 b-ät-i fas fäliṣ-u
 Instr-Det.3MSg ax.Sg PerfS.chop-SM.3MSg
 ‘He chopped it with the ax.’
 b. *ነቲ ፋስ ፈሊጹሉ።
 n-ät-i fas fäliṣ-u-lu
 Obj-Det.3MSg ax.Sg PerfS.chop-SM.3MSg-OM₂.3MSg
 ‘With the ax, he chopped it.’
- The verb can optionally be left out in the response sentences (257a) and (259a). This type of focus is known as argument focus since the inquired information is provided by a single constituent (Lambrecht 1998:226-232). The applicative expression in (257b) or (259a) cannot be given as a reply to the focus question about the referent of the locative or the instrumental participants. In contrast, the applicative expression can be elicited as a response to a question that focuses a predicate (260). In the response, the speaker can choose between the applicative (261a) and the oblique (261b) expressions.
- (260) እቲ መምህር እንታይ ገይሩ፡
 ?it-i mämhir ?intay gäyr-u
 Det-3MSg teacher.Sg what PerfS.do-SM.3MSg
 ‘The teacher, what did he do?’

- (261) a. ነቲ ሰደቻ መጽሐፍ ኣንቢሩሉ ።
 n-ät-i sedeqā mäṣḥaf ʔanbir-u-lu
 Obj-Det-3MSg desk.Sg book.Sg PerfS.put-SM.3MSg-OM₂.3MSg
 ‘He put a book on the desk.’
- b. ኣብቲ ሰደቻ መጽሐፍ ኣንቢሩ ።
 ʔab-t-i sedeqā mäṣḥaf ʔanbir-u
 Loc-Det-3MSg desk.Sg book.Sg PerfS.put-SM.3MSg
 ‘He put a book on the desk.’

Sentence (261a) or (261b) can be evoked as a response to the question in (260). Since the entire clause provides new information, the whole expression is focused. The expressions of the locative and theme argument as well as the verb are obligatory in this clause. In the applicative expression, the locative is expressed as a highly affected object in the event denoted by the verb, and thus highly topical in the discourse (261a), while in the oblique expression, the locative argument is perceived as a mere location where the book is placed, and it is singled out from the other elements to be salient in the discourse (261b). The difference between the applied and oblique expressions of the locative argument is not their discourse referentiality or identifiability, because in both expressions the locative argument has a definite or a presupposed referent. Rather their difference lies in the degree of affectedness and topicality. In the applicative expression, the discourse is about the locative object rather than the theme object. The referent of the applied argument occupies a central point in the verbal event, and thus as directly affected by the verbal event.

The indefinite theme object can also be placed before the locative and the instrumental applied objects in order to render a contrastive focus reading of the theme object, as in (262).

- (262) a. እቲ ኣረስታይ እኸለ ነታ በዓቲ
 ʔit-i ḥaräsitay ʔikli n-ät-a bäʕati
 Det-3MSg farmer.Sg grain Obj-Det-3FSg cave.Sg
 ኣቢኡላ ።
 ḥabiʔ-u-la
 PerfS.hide-SM.3MSg-OM₂.3FSg
 ‘The farmer hid grain in the cave.’
- b. እቲ ሰብኣይ ዕንጨይቲ ነቲ ፋስ
 ʔiti säbʔay ʔinçäyti n-ät-i fas
 Det.3MSg man.Sg wood.Sg Obj-Det-3MSg ax.Sg
 ፈለጹሉ ።
 fäliṣ-u-lu
 PerfS-chop-SM.3MSg-OM₂.3MSg
 ‘The man chopped wood with the ax.’

The focus element is strongly accented. This kind of expression can emerge, for example, in a context where a speaker attempts to correct a false presupposition previously made by another speaker. The elements in focus *ʔikli* ‘grain’ (262a) and *ʔinčäyti* ‘wood’ (262b) stand in opposition to the false information given by the first speaker; for example, if the speaker presupposes that it was sand instead of grain that was hidden in the cave, and stone instead of wood that was chopped with the ax. In Tigrinya, the copula verb *ʔiy-* ‘be’ can be inserted after the focus element in order to give it more emphasis. The resulting construction is comparable to a cleft sentence in English. As the examples in (263) show, the pragmatic focus reading of the fronted theme object is boosted when it is used along with the copular element (see section 2.5, p. 65 for more examples of cleft sentences).

- (263) a. **እቲ ሓረስታይ እኸሊ እዩ ነታ በዓቲ**
ʔit-i ḥaräsitay ʔikli ʔiy-u n-ät-a bäʔati
 Det-3MSg farmer.Sg grain Pres.be-SM.3MSg Obj-Det-3FSg cave.Sg
ሓቢኡላ ።
ḥabiʔ-u-la
 PerfS.hide-SM.3MSg-OM₂.3FSg
 ‘It is grain that the farmer hid in the cave.’
- b. **እቲ ሰብኣይ ዕንጨይቲ እዩ ነቲ ፋስ**
ʔiti säbʔay ʔinčäyti ʔiy-u n-ät-i fas
 Det.3MSg man.Sg wood.Sg Pres.be-SM.3MSg Obj.Det-3MSg ax.Sg
ፈሊሻሉ ።
fäliš-u-lu
 PerfS.chop-SM.3MSg-OM₂.3MSg
 ‘It is wood that the man chopped with the ax.’

The subject and the applied object can also be focused in the same way by insertion of the copular verb after the element that is focused.

The locative/instrumental applicative constructions reveal a different word order constraint than double object clauses with the recipient/beneficiary object clauses when the clause involves a definite theme object. In double object constructions that involve a recipient object and a definite theme object, the word order freezes and the theme object is obligatorily positioned before the recipient object. When a beneficiary applied object co-occurs with a definite theme object, the word order remains flexible. However, in the locative/instrumental applicative constructions a definite theme object cannot be placed before the locative/instrumental applied objects, but has to occur after it, as in (264). Thus, their word order freezes though it has a different freezing pattern than that of the recipient and definite theme objects.

- (264) a. እቲ ሓረስታይ ነታ በዓቲ ነቲ እኽሊ
 ?it-i ḥaräsitay n-ät-a bäʕati n-ät-i ?ikli
 Det-3MSg farmer Obj-Det-3FSg cave Obj-Det-3MSg grain
ሓቢኡላ ።
 ḥabiʔ-u-la
 PerfS.hide-SM.3MSg-OM₂.3FSg
 ‘The farmer hid the grain in the cave.’
- b. እቲ ሰብኣይ ነቲ ፋስ ነቲ ዕንጨይቲ
 ?iti säbʔay n-ät-i fas n-ät-i ?inṣäyti
 Det.3MSg man Obj-Det.3MSg ax.Sg Obj-Det-3MSg wood
ፈሊሻሉ ።
 fäliṣ-u-lu
 PerfS.chop-SM.3MSg-OM₂.3MSg
 ‘The man chopped the wood with the ax.’

When the definite theme object and the applied object are ordered in such a way, they do not code any special pragmatic meaning. In contrast, as we have observed earlier, a definite theme object may precede a recipient/beneficiary object to code a pragmatically neutral reading.

In conclusion, the locative/instrumental applied object and the theme object are not coded by their position with respect to the applied verb. In the unmarked clause, the theme object appears in the immediate preverbal position and the applied object appears in the preceding position. The language allows these objects to switch order in order to code a pragmatically marked reading. The word order in these constructions becomes fixed when the applied object co-occurs with a definite theme object as the theme object is constrained to appear on the preverbal position. In terms of case marking, since the objective case marker can be associated with any applied object and also with definite theme objects, it cannot give us information on object asymmetry. For this reason, it is unable to distinguish between primary and secondary objects. It can distinguish between an applicative and an oblique expression of the locative and the instrumental semantic roles, since an oblique expression that codes these semantic roles is not marked with the objective case *ni-*. The oblique expressions of the locative and instrumental semantic roles are identified with distinct prepositions. With respect to object pronominal marking, the locative and instrumental objects take precedence for verbal marking over the theme object, as do beneficiary applied objects. Due to this property, the applied object may be analyzed as a primary object. However, we refrain from giving a conclusive answer before we analyze their behavior with respect to passivization below (section 8.2.2). In the following sections, we will conduct additional syntactic tests in order to investigate the primary and secondary properties of the objects

in double object constructions.

8.2.2 Passivization

Siewierska (1984:10) points out that after morphological coding, passivization is the second most widely accepted test of transitivity and direct objecthood. Similar to the applicative (chapter 5 discusses the relevance of transitivity for the applicative phenomena), passivization has been dealt with in relation to transitivity in most linguistic theories. The applicative is assumed to increase the transitivity of a clause by adding a core object, whereas the passive is assumed to reduce transitivity of the clause by suppressing the actor/agent argument and by expressing the argument that shows the most patient-like property as a subject. The reason why passivization is proposed as a criterion to distinguish between objects in double object and applicative constructions is that it is assumed to reveal asymmetry by targeting the object with the most patient-like property for the subject function. Consequently, the object that is associated with the argument that shows this disposition is analyzed as a primary object, and the object that associates with the argument that lacks this property is analyzed as a secondary object. Languages differ as to how many of the semantic roles coded in double object or applicative clauses can be targeted by passivization.

Bresnan and Moshi (1993) and Alsina (1996) relate the passive type that a language may have to independent coding properties such as word order and pronominal marking. Alsina (1996:674) argues that the underlying properties of a language manifested in passive typology are the same as those manifested by the descriptive properties of a language, i.e. restrictions on word order and pronominal marking. It is hypothesized that languages that have a double object construction where the two objects involved have equal access to agreement marking also have an *alternating passive* type, which means that the arguments that the two objects bear can be also expressed as subjects in a passive clause. Consequently, the two objects can be designated as primary objects. On the other hand, if the verb prioritizes only one object for pronominal marking, this language has a *non-alternating passive* type (Alsina 1996). According to Bresnan and Moshi (1993), Alsina (1996), and many others, in languages with non-alternating passive type it is the applied argument that shows the readiness to be associated with the subject in a passive clause. Bresnan and Moshi (1993) call the languages that show this pattern *asymmetric applicative* languages. This is the predominant pattern, especially in Bantu languages. As we are going to see in Tigrinya, however, the passive type found in the language is not

necessarily correlated with the independent coding properties of the language.

As demonstrated in the previous section either of the objects of double object clauses with prototypical ditransitive verbs can be marked through object pronominal markers, whereas in double object clauses that contain applied verbs suffixed with OM₂, only one object, the applied object, is obligatorily coded through an object pronominal suffix. Therefore, with regard to pronominal marking both objects in double object clauses with prototypical ditransitive verbs can be analyzed as primary objects, whereas in double object clauses that code applied verbs suffixed with OM₂ only the applied object can be analyzed as a primary object. In this section we will investigate how objects behave under passivization.

Passivization in prototypical ditransitive clauses

In Tigrinya the semantic roles associated with both objects in prototypical ditransitive clauses can be expressed as subjects in passive clauses (Nazareth 2007, 2008), as in (265).

- (265) a. እቶም ተመሃሮ መጽሓፍቲ ተዋሂቦም ።
 ?it-om tāmāhar-o māšḥaf-ti tä-wahib-om
 Det-3MPI student-PI book-PI DT-PerfS.give-SM.3MPI
 ‘The students are given books.’
- b. እቲ መጽሓፍቲ ንተመሃሮ ተዋሂቡ ።
 ?it-i māšḥaf-ti n-itāmāhar-o tä-wahib-u
 Det-3MSg book-PI Obj-student-PI DT-PerfS.give-SM.3MSg
 ‘The books are given to students.’

This alternating passive type is found in constructions with ditransitive verbs such as *wāhabä* ‘he gave’ and *ʿadälä* ‘he distributed’ that are initially subcategorized for two object arguments. Both arguments can function as subjects in a passive construction. Example (265a) codes the recipient argument as a subject, and example (265b) codes the theme argument as a subject.

Another strong piece of evidence for symmetrical objects is the ability of the passive verb to admit an object pronominal suffix for the remaining patient-like argument. This property is absent from asymmetric type languages such as Chicheŵa (Bresnan and Moshi 1993, Alsina and Mchombo 1993). However, as example (266) shows, it is possible in Tigrinya.³

³Note that the plural marking on the inanimate noun *māšḥaf-ti* ‘books’ is interpreted as a collective number in this example, and thus it agrees with a singular determiner and a singular verbal suffix form. The collective reading of plural inanimate nouns is discussed in section 2.3.1, p. 20.

- (266) a. እቶም ተመሃሮ ነቲ መጽሓፍቲ
 ?it-om tāmāhar-o n-ät-i mäṣḥaf-ti
 Det-3MPI student-Pl Obj-Det-3MSg book-Pl
 ተዋሂቦም።
 tä-wahib-om-wo
 DT-PerfS.give-SM.3MPI-OM₁.3MSg
 ‘The students are given the books.’
- b. እቲ መጽሓፍቲ ነቶም ተመሃሮ
 ?it-i mäṣḥaf-ti n-ät-om n-itāmāhar-o
 Det-3MSg book-Pl Obj-Det.3MPI student-Pl
 ተዋሂቡዎም።
 tä-wahib-u-wom
 DT-PerfS.give-SM.3MSg-OM₁.3MPI
 ‘The books are given to the students’

In example (266a), the recipient role is expressed as a subject and the theme is expressed as an object. Consequently, the verb bears a subject pronominal affix that corresponds with the recipient, and an object pronominal suffix that corresponds with the theme object.⁴ Example (266b) shows the reverse, a case in which the theme role is expressed as a subject and it is coded through the subject agreement suffix, while the recipient is expressed as an object and it is coded with the object pronominal suffix. The fact that the passive verb can also admit a pronominal object marker for the theme object when the recipient is expressed as a subject, and for the recipient object when the theme semantic role is expressed as a subject, shows that the theme in (266a) and the recipient in (266b) are core objects. Therefore, Tigrinya has a fully alternating passive type in double object constructions that code theme and recipient objects, and thus both objects exhibit primary object properties also with respect to passivization.

Passivization in applicatives with transitive bases

Even though the beneficiary, the locative and the instrumental semantic roles have precedence for pronominal marking in applicative constructions, these cannot be expressed as subjects in the passive. Rather, it is the theme argument that is associated with the subject in the passive. For example, in (267a) the theme argument is realized as a subject, and the subject verbal suffix corresponds with it. In the passive, a definite subject normally occurs clause initially, and the determiner that specifies it cannot bear the objective case. The definite/individuated beneficiary object can

⁴This sentence can also have a reflexive reading ‘The students gave themselves to the books.’

be marked with the object pronominal suffix OM₂. The beneficiary argument can only be realized as an object in the passive, as in (267).

- (267) a. እቲ መጽሐፍ ንዮናስ ተገዘኡ።
 ʔit-i məšḥaf ni-Yonas tā-tegezi-u-lu
 Det-3MSg book.Sg Obj-Yonas.M DT-perf.buy-SM.3MSg-OM₂.3MSg
 ‘The book was bought (for) Yonas.’
- b. *ዮናስ ነቲ መጽሐፍ ተገዘኡዎ።
 Yonas n-ät-i məšḥaf tā-tegezi-u-wo
 Yonas.M Obj-Det-3MSg book.Sg DT-perf.buy-SM.3MSg-OM₁.3MSg
 ‘Yonas was bought to the book.’

In example (267a) the theme argument is coded as a subject and the beneficiary as an object. The noun that corresponds with the theme argument, *mäšḥaf* ‘book’, is specified by the nominative or unmarked determiner form, and the subject verbal suffix corresponds with it. The noun that corresponds with the beneficiary argument, *Yonas*, bears obligatory objective case, and it corresponds with the object suffix OM₂. In contrast, when we attempt to code the beneficiary as a subject and the theme as an object, as example (267b) shows, the clause becomes ill-formed. The verb is suffixed with the affected object marker OM₁ to code the theme argument. As a result, the sentence expresses an awkward meaning which can be interpreted as ‘Yonas has subjected/submitted himself to the book’. Thus, the beneficiary reading does not come about when the passive verb codes the beneficiary as a subject and the theme as an object.

Similarly, as illustrated in (268a) and (269a), the passive clause codes the theme argument as a subject, and the locative and the instrumental arguments as objects. The locative and the instrumental objects are topicalized (fronted) when they co-occur with an indefinite theme subject. Consequently, the fronted locative and instrumental can be optionally marked with the objective case. Since these objects are the sole topic elements in these passive clauses, the indefinite subject is postposed in the focus position.

- (268) a. እታ/ነታ ሰደጃ መጽሐፍቲ
 ʔit-a/n-ät-a sedeqa məšḥaf-ti
 Det-3FSg/Obj-Det-3FSg desk.Sg book.Pl
 ተገቢሩላ አሎ።
 tā-näbir-u-la ʔall-o
 DT-PerfS.put-SM.3MSg-OM₂.3FSg Pres-be=loc-SM.3MSg
 ‘The desk (F), books have been put on it.’
- b. *እታ ሰደጃ መጽሐፍቲ ተገቢሩ
 ʔit-a sedeqa məšḥaf-ti tänäbir-a-tlu
 Det-3FSg desk.Sg book.Pl DT-PerfS.put-SM.3FSg

ኣላ ።
 ?all-a
 Pres-be=loc-SM.3FSg
 ‘The desk has been put books on.’

- (269) a. **እታ/ጎቲ** **ማሕረሻ ግራት**
 ?it-a/n-ät-a maḥräša girat
 Det-3FSg/Obj-Det-3FSg plough land
ተሓረሱላ ።
 tä-ḥaris-u-la
 DT-PerfS.plough-SM.3MSg-OM₂.3FSg
 ‘The plough, land was plowed with it.’
- b. ***እታ** **ማሕረሻ ግራት ተሓረላ ።**
 ?it-a maḥräša girat tä-ḥaris-a
 Det.3FSg plough land DT-Perf-plough-SM.3FSg
 ‘The plough has been plowed land with.’

These transitive passive verbs can only code the theme argument as a subject. Therefore, the referents of the theme arguments *mäṣḥaf-ti* ‘books’ (268a) and *girat* ‘land/field’ (269a) are expressed as subjects in these examples. The subject suffix in the passive verb cannot cross-reference a locative or an instrumental argument. As a result, the expression of the locative *sedeqa* ‘desk’ and of the instrumental *maḥräša* ‘plough’ as subjects of the passive predicates become ungrammatical, as in (268b) and (269b), respectively.

With respect to passivization, beneficiary, locative and instrumental applied objects do not display primary patient-like properties, whereas the theme object does. As was discussed earlier, according to object pronominal marking, the beneficiary, the locative and the instrumental can be analyzed as primary objects. Applied objects have precedence over theme objects for pronominal marking since they are obligatorily suffixed on the applied verb. Therefore, the two diagnostics, passivization and pronominal marking, seem to detect uncorrelated object properties in these applicative clauses. This may indicate that grammatical processes such as pronominal marking and passivization do not converge to constitute a single underlying primary property of objects cross-linguistically.⁵

As we argued in chapter 5.3.1, applicative clauses in Tigrinya code two types of transitivity traits: one pertaining to *inherent verbal root transitivity* and another pertaining to *discourse motivated clause level transitivity*. Passivization, to a large

⁵As we have demonstrated in the previous section, adjacency to the verb cannot also be taken as a diagnostic in Tigrinya, since object coding is not strictly contingent on structural position in this language.

<p>ተካሪሱ-ዎ/ሉ tä-ḥaris-u-wo/lu DT-PerfS.plough-SM.3MSg-OM₁.3MSg/OM₂.3MSg ‘The plough (M), land was plowed with it.’</p>	<p>ነይሩ ። näy-u Past-be-SM.3MSg</p>
--	--

The suffixes OM₁ and OM₂ code different sense of affectedness. With OM₁ the applied object is perceived as an argument that has been acted upon. However, with OM₂, the applied object is perceived as a mere location or an instrument that was involved in the event without giving emphasis to its engagement in the event.

This complexity suggests that we cannot simply assume that objects coded with OM₁ are primarily affected objects belonging to one category, and those coded with OM₂ are secondarily affected objects belonging to a different category. This is because OM₁ does not consistently code object arguments that reflect a prototypical patient-like property. It can also be associated with object arguments that are perceived as affected by being at the center of the discourse event. Yet, since they are not prototypically affected arguments, they lack a disposition to appear as subjects in a passive clause. For this reason, pronominal markers cannot uniformly categorize applied objects in terms of discourse or semantic affectedness.

Passivization in applicatives with intransitive bases

In 5.3.2 we discussed intransitive verbs that admit the suffixes OM₁ and OM₂ to code different semantic relations. Depending on the semantics of the intransitive base verb, applied objects may reflect various transitivity properties. For example, unaccusative verbs such as *mäwätä* ‘he died’, *ṭäffä?* ‘it/he disappeared/got lost’, *wädäqä* ‘it/he fell’, *mākākä* ‘it/he melted’ *däqäsä* ‘he slept’, etc. can admit OM₁ for ethically affected maleficiary objects or OM₂ for ethically affected beneficiary objects, as in (271a). The applied arguments of unaccusative verbs such as these cannot be expressed as subjects in passive clauses, as shown in (271b).

- (271) a. (ን)እታ ሰበይቲ እቲ ሰኽራ-ዎ ሰብኣያ
 (ni-)ʔi-a säbäyti ʔit-i säkiram säbʔay-a
 (Obj-)Det-3FSg woman Det-3MSg drunken husband-Poss.3FSg
 ጠፊኡ-ዎ/ላ ።
 ṭäfiʔ-u-wa/la
 PerfS.disappear-SM.3MSg-(OM₁/OM₂).3FSg
 ‘(The) her drunken husband disappeared on/for the woman.
- b. *እታ ሰበይቲ ተጠፊኣ ።
 ʔi-a säbäyti tä-ṭäfiʔ-a
 Det-3FSg woman DT-PerfS.disappear-SM.3FSg
 ‘*The woman was disappeared.’

Example (271a) illustrates the two applied object readings: the negatively affected or maleficiary reading and the positively affected or beneficiary reading, coded with OM₁ and OM₂, respectively. The notion of affectedness expressed by the applied clause does not result from a transitive event, i.e. the verbal event does not code an instigator participant that carries out an activity to affect the maleficiary participant. The maleficiary argument is perceived as an affected participant in the abstract or ethical sense. As a result, the applied argument of such verbs cannot be expressed as a subject in a passive clause (271b).

On the other hand, unergative verbs such as *g^wäyäyā* ‘he ran’, *bäṣṣihā* ‘he arrived’, *däyābā* ‘he climbed’, *käyādā* ‘he went’, etc. admit the suffix OM₁ for a goal applied object which is perceived as the end point of the transfer of location, or the OM₂ for a beneficiary applied object, as in (272a). For these verbs, the goal arguments can be expressed as passive subjects (272b). Thus, applicative clauses that involve motion verbs reflect genuine transitivity since they code an agent argument that is perceived as the initiator and an goal argument that is as perceived the endpoint.

- (272) a. **እታ ሰብይቲ ነቲ ቐልዓ ገደያቶ/ትሉ ።**
 ʔit-a säbäyti n-ät-i qolʔa g^wäyy-a-to/tlu
 Det-3FSg woman Obj-Det-3MSg child PerfS.run-SM.3FSg-OM₁/OM₂.3MSg
 ‘The woman chased the child./ The woman ran for the child.’
- b. **እቲ ቐልዓ ተገዶ ።**
 ʔit-i qolʔa tä-goyyiy-u
 Det-3MSg child DT-PerfS.run-SM.3MSg
 ‘The child has been chased/run after .’

In example (272a) the sense of affectedness coded by this verb is transitive in the semantic sense. This clause codes an instigator argument (the runner) whose action affects the goal argument (the one being chased). Due to this notion of affectedness, the clause reflects a prototypical transitivity property, and thus the goal argument can be expressed as the subject of the passive clause (272b).

According to the behavior of applied objects which we have observed in applicative clauses formed out of different types of base verbs (i.e. ditransitive, transitive and intransitive), we argue that, in Tigrinya, passivization and pronominal object markers do not compose a single underlying property of primary objects. These contradicting results suggest that the set of grammatical processes that are assumed to uniformly indicate primary objecthood may not be pointing to the same grammatical property of a language. Therefore, in order to categorize objects in terms of *primary* or *secondary* objects, one needs first to determine which of these

grammatical processes – *passivization* or *pronominal marking* – must be posited as a property of primary objecthood. Indeed, the contradicting results from these tests led some researchers to argue against the use of passivization as a diagnostic of primary objecthood. According to Börjars and Vincent (2008) since passivization involves a ‘a complex interaction between structural position and semantics’, it may be argued that it cannot be a reliable test of grammatical functions. They maintain that objects should be distinguished on the basis of purely syntactic phenomena that involve them. Before we put forward our own conclusions on this matter, we would like to investigate whether objects of double object constructions behave differently with respect to relativization.

8.2.3 Relativization

Relativization is expected to distinguish between objects in languages that restrict relative clause formation to a particular type of object. However, if a language allows both objects of double object or applicative constructions to have access to relativization, then this language is said to have the property of symmetric objects. Moreover, since relativization is expected to affect only core grammatical functions, in languages that employ the applicative coding, an oblique argument can be relativized only when it is expressed via applicative morphology in order to first make a core object out of it (Donohue 1996, Donohue and Donohue 2004). Thus, relativization can be used to diagnose the core object status of applied arguments. Keenan and Comrie (1977) and Comrie (1989) established an accessibility hierarchy (273) in terms of which they state universal constraints on the admittance of grammatical functions to relative clause formation.

(273) *subject > object > non-direct object > possessor*

The intuition behind this is that if relativization is allowed at some point in the hierarchy, then it is also allowed at other positions higher than (to the left of) that point. For example, there cannot be a language that relativizes objects, but not subjects, or relativizes possessors, but not objects. This general tendency has led linguists to employ relativization as a test of primary objecthood in languages that restrict relative clause formation to only one object position. It is assumed that in a language that gives access to the applied object only, the applied object is analyzed as being higher in the hierarchy than the theme object, thus it assumes the primary object function. Otherwise, if it is the theme object that is relativized, then this object is analyzed as the primary object. The objects that do not relativize are analyzed as

secondary objects. In the following section we will investigate the properties of applied objects with respect to relativization in double object and applicative constructions. An introductory discussion on modification with relative clauses can be found in section 2.3.7, p. 38.

In Tigrinya, relativization is indicated through a relative particle *zi-* which is the outermost prefix that marks the relativized verb. The relative clause is prenominal, i.e. it precedes the head noun, as is expected in a SOV language such as Tigrinya. The relative verb form marks which accessibility position is being relativized. In the following examples the string that is enclosed within the square brackets constitutes the relative clause (274).

- (274) a. እታ [ተስፋይ ነቲ መጽሓፍ
 ?it-a Tesfay n-ät-i mäšḥaf
 Det-3FSg Tesfay Obj-Det-3MSg book.Sg
 ዝሃባ/*ቦ] ሰበይቲ
 zi-hab-a/*o säbäyti
 Rel-PerfH.give.SM.3MSg-OM₁.3FSg/*3MSg woman
 መጸኢ ።
 mäši?-a
 PerfS.come-SM.3FSg
 ‘The woman that Tesfay gave the book to (her) came.’
- b. እቲ [ተስፋይ ነታ ሰበይቲ
 ?it-i Tesfay n-ät-a säbäyti
 Det-3MSg Tesfay Obj-Det-3FSg woman.Sg
 ዝሃባ/*ቦ] መጽሓፍ እዚ
 zi-hab-a/*o mäšḥaf ?iz-i
 Rel-PerfH.give.SM.3MSg-OM₁.3FSg/*3MSg book.Sg DetProx-3MSg
 ኢዩ ።
 ?y-u
 Pres.be-SM.3MSg
 ‘The book that Tesfay gave the woman is this one.’

In Tigrinya, both objects of a ditransitive double object construction can be relativized. The recipient object is relativized in (274a), and the theme object is relativized in (274b). The relative predicate bears a subject pronominal suffix that corresponds with the embedded subject *Tesfay*. The determiner which occurs at the leftmost edge specifies the relativized head noun, and thus it concords with the agreement values of the object suffix on the relative verb and the subject suffix on the main verb. The relativized recipient object is obligatorily marked on the relative verb. The clause becomes ungrammatical if the relative verb bears an object suffix for the theme argument (note the object suffix marked with the star symbol in

(274a)). On the other hand, when the relativized head noun is the theme argument, the relative predicate can alternatively code the recipient or the theme argument with the object pronominal suffix (274b). This can be explained based on the double function of the prepositional marker *nī-* (see section 8.2.1, p. 247). Since the marker *nī-* serves as an objective case marker and as a selected preposition to mark the semantic relation of the recipient and the beneficiary arguments, the relativized recipient is ambiguously coded as a core object and as an object of a preposition. As we are going to see in the following discussion, we observe the same restriction when the theme object is relativized in the presence of a beneficiary argument (275). However, since source, locative and instrumental arguments possess distinct prepositions, they are easily identified when they are coded as obliques in relative clauses. Below we demonstrate the relativization of the beneficiary/source (275a) and theme (275b) arguments.

- (275) a. **እታ** [ተስፋይ ነቲ መጽሓፍ
 ?it-a Tesfay n-ät-i mäṣṣhaf
 Det-3FSg Tesfay Obj-Det-3MSg book.Sg
ዝገዘአ/*እ ሰበይቲ እዚአ
 zi-gäzi?-ä-la/*o säbäyti ?izi-?a
 Rel-PerfH.buy-SM.3MSg-OM₂.3FSg/*OM₁.3MSg woman ProxPro-3FSg
እያ ።
 ?iy-a
 Pres.IDcop.be-SM.3FSg
 ‘The woman who Tesfay bought the book for/from is this one.’
- b. **እቲ** [ተስፋይ ነታ ሰበይቲ
 ?it-i Tesfay n-ät-a säbäyti
 Det-3MSg Tesfay Obj-Det-3FSg woman.Sg
ዝገዘአ/እ መጽሓፍ እዚ
 zi-gäzi?-ä-la/o mäṣṣhaf ?iz-i
 Rel-PerfH.buy-SM.3MSg-OM₂.3FSg/OM₁.3MSg book.Sg DetProx-3MSg
እያ ።
 ?iy-u
 Pres.IDcop.be-SM.3MSg
 ‘The book which Tesfay bought for the woman is this one.’
- c. **እቲ** [ተስፋይ ካብ’ታ ሰበይቲ
 ?it-i Tesfay kab-’t-a säbäyti
 Det-3MSg Tesfay ABL-Det-3FSg woman.Sg
ዝገዘአ/*እ መጽሓፍ
 zi-gäzi?-o/la mäṣṣhaf
 Rel-PerfH.buy-SM.3MSg-OM₁.3MSg/*OM₂.3FSg book.Sg
እዚ **እያ** ።
 ?iz-i ?iy-u
 DetProx-3MSg Pres.IDcop.be-SM.3MSg
 ‘The book which Tesfay bought from the woman is this one.’

As example (275a) shows, when the beneficiary is relativized, the object suffix on the relative verb must agree with it, as with the relativization of the recipient illustrated above (274a). Consequently, the expression becomes ungrammatical if the object suffix cross-references the theme argument. The referent of the relativized noun can also be interpreted as having a source argument reading. When the relativized head noun corresponds with the theme argument (275b), the relative verb can alternatively code the theme or the beneficiary/source arguments with the pronominal suffix. However, with the relative verb coding the theme object, we cannot get the source argument reading. Instead the source must be coded as an oblique expression to express the reading of a source semantic role, as is illustrated in (275c). This can be taken as an indication that the beneficiary also has an oblique function when the relative verb codes the theme object. Thus, it supports the analysis of *ni-* as a prepositional marker when the verb does not bear a suffix for the beneficiary argument.

As with the recipient, the beneficiary and the source, when the relativized head noun bears a locative semantic role the object verbal suffix obligatorily cross-references it (276a).

- (276) a. እታ [ተስፋይ ነቲ መጽሐፍ
 ?it-a Tesfay n-ä-ti mäṣṣəḥaf
 Det-3FSg Tesfay Obj-Det-3MSg book.Sg
 ዘንበረላ/*ዘንበሮ
 z-ä-nibärä-la/*z-ä-nnibär-o
 Rel-Caus-PerfH.sit.SM.3MSg-OM₂.3FSg/*Rel-Caus-PerfH.sit.SM.3MSg-OM₁.3MSg
 ሰደቻ እዚኣ እያ #
 sedeḩa ?izi-?a ?iy-a
 desk.Sg DetProx-3FSg Pres.IDcop.be-SM.3FSg
 ‘The desk that Tesfay put the book on is this one.’
- b. እቲ [ተስፋይ ነታ ሰደቻ
 ?it-i Tesfay n-ät-a sedeḩa
 Det-3MSg Tesfay Obj-Det-3FSg desk.Sg
 ዘንበረላ/*ዘንበሮ
 z-ä-nnibärä-la/*z-ä-nnibär-o
 Rel-Caus-PerfH.sit.SM.3MSg-OM₂.3FSg/*Rel-Caus-PerfH.sit.SM.3MSg-OM₁.3MSg
 መጽሐፍ እዚ ኣያ #
 mäṣṣəḥaf ?iz-i ?iy-u
 book DetProx-3MSg Pres.IDcop.be-SM.3MSg
 ‘The book that Tesfay put on the desk is this one.’
- c. እቲ [ተስፋይ ኣብ’ታ ሰደቻ
 ?it-i Tesfay ?ab-’t-a sedeḩa
 Det-3MSg Tesfay Loc-Det-3FSg desk.Sg

ዘንበሮ/*ዘንበረላ]

z-ä-nnibär-o/*z-ä-nnibärä-la

Rel-Caus-PerfH.sit.SM.3MSg-OM₁.3MSg/*Rel-Caus-PerfH.sit.SM.3MSg-OM₂.3FSg**መጽሐፍ እዚ ኢዩ።**

mäṣḥaf ʔiz-i ʔiy-a

book.Sg DetProx-3MSg Pres.IDcop.be-SM.3MSg

‘The book which Tesfay put on the desk is this one.’

Moreover, when the relativized head noun corresponds with the theme argument, the locative can also be expressed as an applied object on the relative verb (276b). However, if the verbal suffix on the relative verb corresponds with the theme object, the locative is expressed as an oblique, similar to the source argument (276c). Therefore, the relativized clause can code an applied locative as long as the relative verb bears a suffix for it, and in this structure, either of the objects can be relativized.

In contrast, the instrumental argument behaves differently with respect to relativization. When the relativized argument is an instrumental applied object, the relative verb obligatorily bears the object suffix for it. However, when the relativized argument is a theme, the instrumental argument is expressed in a prepositional phrase (277).

- (277) a. **እቲ** [ተስፋይ ነታ **ገረብ**
ʔit-i Tesfay n-ät-a gä-räb
Det-3MSg Tesfay Obj-Det-3FSg tree.Sg

ዝቈረጸሉ/*ዝቈረጸ]zi-q^wä-räṣä-lu/*zi-q^wä-räṣ-aRel-PerfH.cut-SM.3MSg-OM₂.3MSg/*Rel-PerfH.cut.SM.3MSg-OM₁.3FSg**ፋስ እዚ ኢዩ።**

fas ʔiz-i ʔiy-u

ax.Sg DetProx-3MSg Pres.IDcop.be-SM.3MSg

‘The ax with which Tesfay cut the tree is this one.’

- b. ***እታ** [ተስፋይ ነቲ **ፋስ**
ʔit-a Tesfay n-ät-i fas
Det-3FSg Tesfay Obj-Det-3MSg ax.Sg

ዝቈረጸ/ዝቐረጸሉ]zi-q^wäräṣ-a/zi-q^wäräṣ-ä-luRel-PerfH.cut.SM.3MSg-OM₁.3FSg/Rel-PerfH.cut-SM.3MSg-OM₁.3MSg**ገረብ እዚ ኢዩ።**

gä-räb ʔizi-ʔa ʔiy-a

tree.Sg ProxPro-3FSg Pres.IDcop.be-SM.3FSg

‘The tree that Tesfay cut for/with the ax is this one.’

- c. **እታ** [ተስፋይ በቲ **ፋስ**
ʔit-a Tesfay b-ät-i fas
Det-3FSg Tesfay Instr-Det-3MSg ax.Sg

<p>ዝገየየቶ/ሉገ zi-gäyäy-ät-o/lu Rel-PerfH.run-SM.3FSg-OM₁.3MSg/OM₂.3MSg ኢዩ ። ?iy-u Pres.IDcop.be-SM.3MSg</p>	<p>ቀልዓ ኢዚ qolſa ?iz-i child DetProx-3MSg</p>
--	--

‘The child who the woman ran after is this one.’

In examples (278a) and (278b) the intransitive relative verbs bear object suffixes for the applied objects. In (278a) the relativized intransitive verb can bear either OM₁ to express the maleficiary reading or OM₂ to express the beneficiary reading. Similarly, in example (278b) the relativized verb can bear OM₁ to code goal object or OM₂ to code a beneficiary object, and these arguments correspond to the relativized head noun which is the subject of the main clause.

To sum up, according to the results from relativization, Tigrinya has symmetrical applicative constructions with beneficiary, source and locative applied objects, but instrumental applicative clauses reveal an asymmetric property, since only instrumental objects are extractable through relativization. Thus, the property revealed by beneficiary, source, locative and instrumental applied objects under relativization does not correlate with the property revealed by passivization. As we noted in section 8.2.2, none of these object arguments can be expressed as subjects in passive clauses. However, the property reflected with beneficiary, source and locative applied objects with respect to relativization does converge with the property revealed with respect to pronominal marking. Even though the theme object is extractable by the relativization strategy, it cannot control object marking on the verb, since this would result in oblique coding of the argument that otherwise may appear as an applied object. Therefore, even though relativization in Tigrinya predicts the core object status of the two objects in applicative constructions, it does not predict the asymmetric properties that objects reflect under passivization. This is because relativization indistinctively applies to all objects in applicative clauses with the exception of the theme object in instrumental applicatives. Given its function as a topicalization strategy, relativization codes the relative topicality of objects, being a base or an applied object. Therefore, it can apply to any object that has the ability to be expressed as a core object.

8.3 Which primary object property?

In section 8.2 we observed that the set of diagnostics that we have employed do not reliably predict correlated grammatical properties of objects. Grammatical tests such as case marking, pronominal suffixation and passivization do not seem to detect the same grammatical properties of objects in the Tigrinya applicative data we have investigated. In the discussion of transitivity (chapter 5.3.1), we pointed out that the degree of affectedness that object arguments display is a crucial factor for their involvement in passive expressions. In Tigrinya, passivization tends to involve object arguments which are semantically denoted in the meaning of the base verb. Thus, it is exclusively reserved for undergoer arguments that are perceived as being genuinely or directly affected by the event described by the verb. In this sense, passivization necessitates semantic affectedness of object arguments, a notion that is particularly associated with the lexical semantics of the verb.

With respect to passivization, Tigrinya has symmetrical and asymmetrical double object constructions. Double object constructions that involve prototypical ditransitive verbs reflect a symmetrical pattern, since either of the object arguments (i.e. the theme or the recipient) can be realized as the subject of a passive clause. Nevertheless, even though both objects have the semantic property of affectedness required for indexation with OM_1 , the object suffix that is associated with primary patient-like arguments, only one object at a time can be selected for verbal suffixation. The object that is selected is perceived to have a high degree of discourse topicality, which in turn suggests that object pronominal suffixes should be identified as markers of topicality. An analysis that regards verbal marking of objects as an indication of primary objecthood may wrongly equate the discourse topicality of objects with their semantic affectedness. The fact that these objects are marked with the object suffix form - OM_1 rather than OM_2 indicates that they are semantically affected objects, but the fact that only one of them is picked for verbal affixation suggests that the selected object has high discourse topicality.

On the other hand, double object clauses that involve applied arguments show an asymmetrical pattern. Since applied arguments are not lexically predicted as affected arguments of a verb, they do not display a genuine patient-like property, and thus cannot undergo passivization. In these clauses, only the theme argument can be realized as the subject of a passive clause. However, since applied objects are expressed as the most topical objects in discourse, they are prioritized for pronominal marking and coded as nominal objects (as opposed to prepositional objects).

In double object applicative clauses, applied objects are identified with the verbal suffix OM_2 which typically marks indirectly affected objects. OM_2 contains the prepositional particle $\mathbf{\Delta}/li-$ which marks the semantic restrictedness of applied arguments (a repertoire of the different forms of OM_1 and OM_2 is given in section 4.3). Jackendoff (1990:294) employs the term ‘discourse patient’, as opposed to semantic patient, to characterize an object that reflects a comparable grammatical property to that of an applied object.

In the standard LMT analysis object arguments that show a primary patient-like property under passivization are assigned the syntactic classification $[-r]$ which leads them to be linked with the unrestricted object, i.e. OBJ (refer to section 7.5.1, p. 223). The arguments that do not passivize are assumed to show a secondary patient-like property, and thus they receive the feature classification $[+o]$, which leads them to be associated with the restricted object (OBJ_θ). However, the method of binary feature decomposition $[+/-r]$ and $[+/-o]$ that LMT employs does not seem to capture the manifold properties that objects reflect in various grammatical processes. This flaw in LMT is especially reflected in the analysis of Tigrinya symmetrical constructions where the two object arguments show similar affectedness properties with respect to some diagnostics, and yet are coded as distinct objects by the complex interplay of coding strategies. LMT employs the object categories OBJ, described as $[-r]$, and OBJ_θ , described as $[+o]$, to capture their distinctness, but by doing so it loses track of their similarity. In the remainder of this section, we will elaborate further upon the different grammatical processes on the basis of which objects are analyzed as primary or as secondary objects. We will particularly focus on the two notions of affectedness, semantic and discourse, which we assume are the motivations for the variability of objects in symmetrical and asymmetrical constructions in Tigrinya.

8.3.1 Affectedness of symmetrical objects

As we noted in section 7.5.3, p. 232) in connection with symmetrical languages such as Kichaga and Kinyarwanda, since classifying two object arguments as $[-r]$ in an active predicate will lead to a violation of the well-formedness condition, it is proposed that the theme argument alternatively receives the $[+o]$ feature, which will lead to its mapping to the restricted object (OBJ_θ). Nevertheless, even though such an analysis fixes the violation of the biuniqueness condition that requires unique arguments to be associated with to unique grammatical functions, it does not take into consideration the ability of the theme object to passivize.

Since passivization is not sufficient to predict the difference that is assumed to exist between these seemingly symmetric objects, other grammatical clues are needed to show their distinctness. For instance, there is one grammatical clue in Tigrinya that can suggest that objects in symmetrical constructions assume distinct functions. In terms of *case marking* patterns, it is the theme object that reflects similar coding behavior to the object of a monotransitive clause. In monotransitive and ditransitive clauses, the theme object acquires case marking only when it is definite, whereas case marking of recipient objects in ditransitive clauses does not depend on definiteness. Both definite and indefinite recipient objects are obligatorily case marked with the objective case *ni-*. This may suggest that recipient arguments are lexically specified to appear as case marked objects, and therefore can be analyzed as semantically restricted objects (OBJ_{θ}). This leaves the option for OBJ to be restricted to the theme/patient role also. As a result, as Börjars and Vincent (2008) have proposed for English ditransitive clauses, since all objects appear to be restricted to a particular semantic role, there is no need to distinguish between OBJ and OBJ_{θ} .

However, this analysis is at odds with the theoretical assumptions laid out in LMT, since the OBJ_{θ} classification is reserved for non-passivizable arguments. For Börjars and Vincent (2008) this issue becomes irrelevant, since they rule passivization out as a diagnostic of grammatical relations, arguing that it interacts with word order and semantics in the English ditransitive clause. In their view, it cannot be regarded as reliable test of grammatical relations. For example, they point out that in the English ditransitive clause passivization selects the first noun phrase as the real object that reflects similar properties to the object of a monotransitive clause. In the Tigrinya ditransitive clause, however, passivization is not conditioned by phrase position, since either of the object arguments can be realized as a subject in a passive clause regardless of the semantic role they bear. As we discussed in section 8.2.2, in Tigrinya, passivization reveals an important distinction between directly/genuinely affected and indirectly/incidentally affected objects; therefore, it should be regarded as a meaningful test of transitivity or affectedness. Based on this observation, we argue that the OBJ_{θ} classification can neither properly describe the theme nor the recipient object in Tigrinya. As the various syntactic realizations of the recipient object show, the recipient does not appear to be semantically restricted in the normal sense. Even though the prepositional marker *ni-* is obligatory for the recipient, it does not uniquely identify the recipient. This case marker is also associated with definite theme objects and applied objects, as was discussed

in section 6.3.1. Therefore, this marker cannot be regarded only as a semantic case for recipient objects.

Moreover, the two patient-like arguments of ditransitive clauses are distinctly coded through a complex interplay of word order, case marking and pronominal suffixes. However, the binary feature decomposition method that LMT employs to differentiate objects cannot adequately capture the interaction of the coding strategies. Using the binary feature decomposition, we cannot express the fact that both objects in ditransitive clauses are primary patient-like objects, and yet they are also distinct, without resorting to the OBJ_{θ} function. The interaction of the object coding strategies which was discussed in section 8.2.1 is summarized in Table 8.1.⁶

Context 1	indef. $OBJ_{recipient}$		indef. OBJ_{theme}
Case (ni-)	+		-
Verbal suffix (OM_1)	-		-
Word order	>	or	>
Context 2	def. $OBJ_{recipient}$		indef. OBJ_{theme}
Case (ni-)	+		-
Verbal suffix (OM_1)	+		-
Word order	>	or	>
Context 3	def. OBJ_{theme}		indef. $OBJ_{recipient}$
Case (ni-)	+		+
Verbal suffix (OM_1)	+		-
Word order		>!	
Context 4	def. OBJ_{theme}		def. $OBJ_{recipient}$
Case (ni-)	+		+
Verbal suffix (OM_1)	+	or	+
Word order		>!	

Table 8.1: Coding pattern of objects in ditransitive clauses

Context 1

The two objects can be distinguished, since an indefinite $OBJ_{recipient}$ is marked with case, while an indefinite OBJ_{theme} is not. Moreover, the two objects can also switch their positions in order to derive a pragmatically marked reading. However, since both objects are indefinite, they cannot be pronominally marked. In Context 1, the OBJ_{theme} can be analyzed as the primary object (OBJ) since it resembles the indefinite/unmarked object of a monotransitive clause, whereas the $OBJ_{recipient}$ can be

⁶The symbol '>' represents a precedence relation and the symbol '>!' represents an obligatory precedence relation.

assumed to be a restricted object (OBJ_{θ}) due to its prepositional marking, as illustrated in (279).

(279) Indefinite theme and recipient objects

theme	recip
OBJ	OBJ_{θ}

Context 2

In this context, since OBJ_{recip} is definite, it acquires pronominal marking. As in Context 1, the objects can switch their order since they are identified with different case patterns: OBJ_{recip} is marked, whereas OBJ_{theme} is unmarked. There are various alternative ways in which the two objects can be analyzed based on the marking patterns. If we take pronominal marking as a signal of primary objecthood, then the OBJ_{recip} would assume the primary object function (OBJ), and the theme object would be restricted (OBJ_{θ}) since it is not preferred for pronominal marking (280a). On the other hand, if pronominal marking is interpreted as a signal of discourse topicality, the recipient can retain the OBJ_{θ} function, and in addition, it can be analyzed as a topic object (280b).

(280) Indef. theme object and def. recipient object

<p>a. Recipient analyzed as OBJ and Topic</p> <table style="margin-left: auto; margin-right: auto;"> <tr> <td style="padding-right: 20px;">theme</td> <td>recip</td> </tr> <tr> <td style="text-align: center;"> </td> <td style="text-align: center;"> </td> </tr> <tr> <td style="padding-right: 20px;">OBJ_{θ}</td> <td>OBJ</td> </tr> <tr> <td></td> <td style="text-align: center;"> </td> </tr> <tr> <td></td> <td>Topic</td> </tr> </table>	theme	recip			OBJ_{θ}	OBJ				Topic	<p>b. Recipient analyzed as OBJ_{θ} and Topic</p> <table style="margin-left: auto; margin-right: auto;"> <tr> <td style="padding-right: 20px;">theme</td> <td>recip</td> </tr> <tr> <td style="text-align: center;"> </td> <td style="text-align: center;"> </td> </tr> <tr> <td style="padding-right: 20px;">OBJ</td> <td>OBJ_{θ}</td> </tr> <tr> <td></td> <td style="text-align: center;"> </td> </tr> <tr> <td></td> <td>Topic</td> </tr> </table>	theme	recip			OBJ	OBJ_{θ}				Topic
theme	recip																				
OBJ_{θ}	OBJ																				
	Topic																				
theme	recip																				
OBJ	OBJ_{θ}																				
	Topic																				

Notice, however, that these objects are given the restricted and unrestricted interpretations based on different grammatical properties. In (279) the restricted object analysis of the OBJ_{recip} is based on its obligatory case marking, whereas in (280a) the restricted object analysis of the theme argument is based on its not being preferred for pronominal marking. In contrast, in Context 1 the theme object is analyzed as OBJ since it resembles the indefinite object of a monotransitive clause, as it does not involve case marking and pronominal indexation. Yet, the same properties are interpreted as motivating the restricted status of the theme argument in

(280a). For the time being, we can say that for Context 2 the second option (280b) appears to be the optimal analysis. Here the grammatical function of the objects is resolved on the basis of their semantic restrictedness. The theme object is analyzed as OBJ since it is not inherently associated with the prepositional marker. On the other hand, pronominally marked objects can be analyzed as discourse topics.

Context 3

In this context, since the theme object is definite, it involves case marking and pronominal indexation. In this pattern, both objects are identified with the same case marker, and as a result their word order becomes fixed. The theme object reflects a case marking and pronominal suffix pattern similar to that of a definite object of a monotransitive clause, and therefore, it can be analyzed as a primary object (281a). Moreover, since the definite theme object has precedence for pronominal indexation, it can be analyzed as a topical object.

(281) Definite theme object

- a. Theme analyzed as OBJ and Topic
- | | |
|-------|------------------|
| theme | recip |
| | |
| OBJ | OBJ _θ |
| | |
| Topic | |
- b. Theme analyzed as OBJ_θ and Topic
- | | |
|------------------|------------------|
| theme | recip |
| | |
| OBJ _θ | OBJ _θ |
| | |
| Topic | |

An alternative interpretation could be that both objects become OBJ_θ since both bear the same case marker, as in (281b). This analysis infers that an unmarked/indefinite object and a marked/definite object of a monotransitive clause assume different grammatical functions. However, since in Tigrinya these objects do not show further different grammatical properties on the basis of their definiteness status, the coding difference cannot be taken as a signal of their difference in grammatical function. This discussion will be taken up later in section 8.3.3.

Context 4

In this context both objects are definite, and thus are marked for case. Further, they are coded by a fixed word order as in Context 3. However, in Context 4 either of

the objects can be selected for pronominal marking, depending on the discourse topicality they are accorded. The object that has high discourse topicality will be selected for pronominal marking, and accordingly the marked object can assume the primary object function (OBJ) and also be the topic of the discourse, whereas the object that is dispreferred for pronominal marking can appear as OBJ_{θ} . This is represented in (282).

(282) both definite objects

<p>a. Theme analyzed as OBJ and Topic</p> <table style="margin-left: 40px; border-collapse: collapse;"> <tr> <td style="text-align: center; padding: 5px;">theme</td> <td style="text-align: center; padding: 5px;">recip</td> </tr> <tr> <td style="text-align: center; padding: 5px;"> </td> <td style="text-align: center; padding: 5px;"> </td> </tr> <tr> <td style="text-align: center; padding: 5px;">OBJ</td> <td style="text-align: center; padding: 5px;">OBJ_{θ}</td> </tr> <tr> <td style="text-align: center; padding: 5px;"> </td> <td></td> </tr> <tr> <td style="text-align: center; padding: 5px;">Topic</td> <td></td> </tr> </table>	theme	recip			OBJ	OBJ_{θ}			Topic		<p>b. Recipient analyzed as OBJ and Topic</p> <table style="margin-left: 40px; border-collapse: collapse;"> <tr> <td style="text-align: center; padding: 5px;">theme</td> <td style="text-align: center; padding: 5px;">recip</td> </tr> <tr> <td style="text-align: center; padding: 5px;"> </td> <td style="text-align: center; padding: 5px;"> </td> </tr> <tr> <td style="text-align: center; padding: 5px;">OBJ_{θ}</td> <td style="text-align: center; padding: 5px;">OBJ</td> </tr> <tr> <td></td> <td style="text-align: center; padding: 5px;"> </td> </tr> <tr> <td></td> <td style="text-align: center; padding: 5px;">Topic</td> </tr> </table>	theme	recip			OBJ_{θ}	OBJ				Topic
theme	recip																				
OBJ	OBJ_{θ}																				
Topic																					
theme	recip																				
OBJ_{θ}	OBJ																				
	Topic																				

The analysis of the grammatical function of the objects is resolved on the basis of their discourse status, i.e. the object that is marked on the verb is taken to be a primary object (OBJ). However, these analyses do take into consideration the prepositional marker of these objects. If we consider case marking, then we get the following patterns (283).

(283) both definite

<p>a. Recipient analyzed OBJ_{θ} and Topic</p> <table style="margin-left: 40px; border-collapse: collapse;"> <tr> <td style="text-align: center; padding: 5px;">theme</td> <td style="text-align: center; padding: 5px;">recip</td> </tr> <tr> <td style="text-align: center; padding: 5px;"> </td> <td style="text-align: center; padding: 5px;"> </td> </tr> <tr> <td style="text-align: center; padding: 5px;">OBJ</td> <td style="text-align: center; padding: 5px;">OBJ_{θ}</td> </tr> <tr> <td></td> <td style="text-align: center; padding: 5px;"> </td> </tr> <tr> <td></td> <td style="text-align: center; padding: 5px;">Topic</td> </tr> </table>	theme	recip			OBJ	OBJ_{θ}				Topic	<p>b. Both analyzed as OBJ_{θ}</p> <table style="margin-left: 40px; border-collapse: collapse;"> <tr> <td style="text-align: center; padding: 5px;">theme</td> <td style="text-align: center; padding: 5px;">recip</td> </tr> <tr> <td style="text-align: center; padding: 5px;"> </td> <td style="text-align: center; padding: 5px;"> </td> </tr> <tr> <td style="text-align: center; padding: 5px;">OBJ_{θ}</td> <td style="text-align: center; padding: 5px;">OBJ_{θ}</td> </tr> </table>	theme	recip			OBJ_{θ}	OBJ_{θ}
theme	recip																
OBJ	OBJ_{θ}																
	Topic																
theme	recip																
OBJ_{θ}	OBJ_{θ}																

The analysis (283a) treats the recipient object as an OBJ_{θ} function due to its inherent case marking. Similarly, due to its case marking the definite theme object can also be assumed to be restricted. Consequently, both object arguments may be restricted functions, as in (283b). Moreover, either object can assume a topic function for being cross-referenced on the verb. These contexts illustrate the difficulty

of identifying the OBJ and OBJ_θ function in the Tigrinya ditransitive clause. Either of the objects can assume OBJ or OBJ_θ, due to the alternative interpretation that the coding strategies (case marking and pronominal suffixation) acquire on the basis of their definiteness status and discourse topicality. The ambiguity arises because of the overlapping analysis given to the markers, as in the following:

- *ni-* is inherent case which marks the semantic role of the recipient object
- *ni-* is a structural case which identifies a definite object of a monotransitive clause
- object verbal suffixes signal primary objecthood
- object verbal suffixes signal discourse topicality

The descriptive facts in Tigrinya reveal that the marker *ni-* is a semantic case for the recipient object which distinguishes it from the theme object in the contexts where the theme object does not bear this marker. In LFG, objects that are obligatorily marked with semantic case are analyzed as OBJ_θ – the grammatical function given to a secondary patient-like argument. On the other hand, since in monotransitive clauses *ni-* associates only with a definite theme object, it is taken as marking individuation, not semantic restrictedness. Thus, in monotransitive clauses both realization – marked/definite and unmarked/indefinite – of the theme object are resolved as OBJ (refer to section 8.3.3 for further discussion). When we carry this reasoning over to ditransitive clauses, the OBJ_{recip} that triggers verbal agreement can be considered to have an OBJ function. In this case, we can interpret the *ni-* marker as a polysemous preposition which functions as a semantic case marker for recipient arguments and as a marker of accusative definite objects.

On the other hand, if we take the passivization property of the recipient object into consideration, neither of the object arguments should be identified as OBJ_θ. The restricted object category cannot capture the fact that both object arguments reflect primary patient-like traits. Therefore, we conclude that as it is currently laid out in LMT the object classifications as OBJ and OBJ_θ cannot properly account for the property of symmetric objects in Tigrinya ditransitive clauses.

8.3.2 Affectedness of asymmetrical objects

In applicative constructions, only the theme argument can become a subject in passive clauses. Thus, with respect to passivization, only the theme object can be regarded as the OBJ function. The applied object is obligatorily cross-referenced on

the verb through the applicative suffix (OM₂), and it is also obligatorily marked with the case marker *ni-*. The case marker is not inherently related to applied objects, since the semantic roles that are associated with applied objects are marked with distinct prepositions when they are expressed as prepositional phrases. The coding pattern of objects in double object applicative clauses is summarized in Table 8.2.

Context 1	indef. OBJ _{theme}	OBJ _{ben}
Case (<i>ni-</i>)	-	+
Verbal suffix (OM ₂)	-	+
Word order	> or	<
Context 2	def. OBJ _{theme}	OBJ _{ben}
Case (<i>ni-</i>)	+	+
Verbal suffix (OM ₂)	-	+
Word order	> or	<
Context 3	def. OBJ _{theme}	OBJ _{ben}
Case (<i>ni-</i>)	+	+
Verbal suffix (OM ₁)	+	-
Word order		>!
Context 4	indef. OBJ _{theme}	OBJ _{instr/loc}
Case (<i>ni-</i>)	-	+
Verbal suffix (OM ₂)	-	+
Word order	> or	<
Context 5	def. OBJ _{theme}	OBJ _{instr/loc}
Case (<i>ni-</i>)	+	+
Verbal suffix (OM ₂)	-	+
Word order		<!
Context 6	def. OBJ _{theme}	OBL _{instr/loc}
Case (<i>ni-</i>)	+	-
Prep. (<i>?ab, bi-</i>)	-	+
Verbal suffix (OM ₁)	+	-
Word order	> or	<

Table 8.2: Coding pattern of applied objects

Contexts 1, 2 and 3

The default word order is the one in which the beneficiary object precedes the theme object, but the objects can also switch position in order to express a pragmatically marked meaning. However, when the verb bears the suffix for the theme object, their word order becomes fixed. The beneficiary object bears the prepositional marker *ni-* even when it is not cross-referenced on the verb. Since the theme

object and the beneficiary object are coded with different forms of verbal suffixes, they do not reflect the ambiguity found in ditransitive clauses.

(284) Beneficiary applied objects

a. Pronominalization

ben	theme
OBJ	OBJ _θ
Topic	

b. Passivization

ben	theme
OBJ _θ	OBJ
Topic	

In (284a), the beneficiary argument can be regarded as a non-restricted function because it is obligatorily marked on the verb. However, since it cannot undergo passivization, it can also be analyzed as a restricted function, as in (284b). In these patterns, only the beneficiary applied object can be associated to the topic function.

Contexts 4, 5 and 6

The applied objects which bear locative, source and instrumental roles canonically appear before an indefinite theme object, but they can switch position with the theme object when they code a pragmatically marked meaning. However, in a context with a definite theme object, their word order becomes fixed. The *ni-* case marker is associated with the applied objects only when they are cross-referenced on the verb. Since applied objects are obligatorily cross-referenced on the verb, they can be analyzed as primary objects, as in (285a).

(285) Instr, loc and source applied arguments

a. Pronominalization

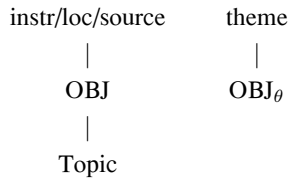

b. Passivization

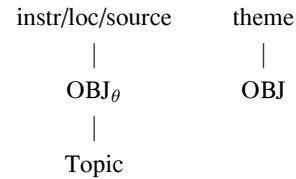

When the verb marks the theme object, the applied semantic roles are expressed with distinct prepositions that mark their semantic relations. The asymmetrical pattern reflected by objects in applicative clauses is manifested by their behavior in passivization and also the type of verbal suffix with which they are associated. The suffix OM₂ marks non-passivizable applied objects. Therefore, based on these properties, these applied objects should assume the OBJ_θ function, as in (285b). Moreover, since they have highly individuated referents, they are also analyzed as discourse topics.

In standard LMT, since applied objects are obligatorily marked through the applied suffix, and verbal marking is interpreted as a behavior of primary objects, applied objects are thought to assume the OBJ function. The fact that the object argument that is selected for passivization does not correspond to the argument prioritized for pronominal marking further indicates that diagnostics such as passivization and pronominal/case marking do not detect correlated grammatical properties of objects.

The properties which distinguish OBJ from OBJ_θ in the symmetrical constructions are different from those used to identify similar categories in the asymmetrical constructions. In the asymmetric applicative, the object argument's ability to passivize and the type of verbal suffixes that are associated with non-passivizable objects support the OBJ vs. OBJ_θ distinction according to the theoretical assumptions maintained in LMT. However, in the symmetrical constructions, since passivization cannot distinguish between the two object functions, we have attempted to ascertain whether such a distinction may be based on the complex interplay of word order, case and pronominal marking. However, since restrictions on coding strategies can acquire alternative interpretations, these strategies are not well suited to identify the OBJ vs. OBJ_θ functions. Nevertheless, the complex coding interplay shows that the two objects in ditransitive clauses are identifiable even though their distinctness cannot be properly classed into the OBJ and OBJ_θ functions. The fact

that the object classified as OBJ_{θ} cannot simultaneously be analyzed as affected object indicates that LMT cannot properly account for the properties of objects in symmetric constructions. On the other hand, the object properties reflected in asymmetrical applicatives can be easily accounted for in LMT if we assume that applied objects correspond to restricted objects (OBJ_{θ}). The pattern reflected in asymmetrical applicatives suggest that in Tigrinya only object arguments that are semantically denoted as affected objects in the verbal event can be analyzed as primarily patient arguments, whereas applied objects are perceived as discourse patients, and by virtue of their verbal coding they assume a topic discourse function.

8.3.3 Affectedness of monotransitive objects

In Tigrinya, definite objects trigger both case and pronominal suffix marking, whereas indefinite objects do not. This is discussed under the phenomenon of differential object marking (DOM) (refer to chapter 9 for detailed discussion on this topic). In monotransitive clauses, the marked/definite objects and the unmarked/indefinite objects do not reflect differences in syntactic behavior. For example, both objects can participate in an object control construction such as the purposive complement. In this structure, the subject of the purposive dependent clause is interpreted as the object of the main clause, regardless of whether the objects are indefinite/unmarked (286a) or definite/marked (286b).

- (286) a. **እቲ ንጉስ ሓንቲ ሰበይቲ ናብኡ**
 ?it-i nigus ḥa-nti säbäyti nab-u
 Det-3MSg king.Sg one-F woman.Sg to-3MSg
ክትቐርብ ጸዊዑ።
 ki-t-qärib šäwiʿ-u
 Purp-Imperf.3-approach.SM.FSg PerfS.call-SM.3MSg
 ‘The king called a/one woman to approach him.’
- b. **እቲ ንጉስ ነታ ሰበይቲ ናብኡ**
 ?i-i ni-gus n-ät-a säbäyti nab-u
 Det-3MSg king.Sg Obj-Det-3FSg woman.Sg to-3MSg
ክትቐርብ ጸዊዑዋ።
 ki-t-qärib šäwiʿ-u-wa
 Purp-Imperf.3-approach.SM.FSg PerfS.call-SM.3MSg-OM₁.3FSg
 ‘The kind called the woman to approach him.’

Both the indefinite object and the definite object of the matrix verb are understood to be the subject of the dependent purposive verb *ki-t-qärib* ‘she to approach’. This suggests that, in Tigrinya, case marking and pronominal coding of objects do not signal differences in grammatical function, or in other words, they do not indicate

a primary object status. In addition, patient/theme arguments are associated with the passivized subject regardless of whether these have definite or indefinite referents. This suggests that in both instances the objects may be associated with the undergoer arguments which are implied in the lexical meaning of the verb. Instead, case/pronominal marking of objects in monotransitive clauses indicate a difference in the information structure reading of objects. The unmarked object correspond to objects that have non-topical referents, whereas the marked ones are associated with objects that have topical referents.

Næss (2004) argues against the claim that DOM is motivated by a degree of individuation or the referential properties of the referents of marked objects. She maintains that variation in object marking signals *affectedness* of objects in the sense of being participants in verbal events. According to her, affectedness of objects is based on semantic considerations. Marked/definite objects code a higher degree of affectedness than unmarked/indefinite objects. Yet, as the Tigrinya data show, marked/definite objects do not seem to be semantically more involved or affected than indefinite/unmarked objects in the semantic sense. For example, when we compare the readings of a clause with an indefinite object (287a) and a clause with a definite object (287b), we do not get an opposition to the effect that in (287a) the participant is partially affected, and in (287b) it is completely affected. On the contrary, there is no such difference in affectedness.

- (287) a. ሳባ ማይ ሰጉያ ።
 Saba may sätti-y-a
 Saba water PerfS.drink-SM.3FSg
 ‘Saba drank water.’
- b. ሳባ ነቴ ማይ ሰጉያቶ ።
 Saba n-ät-i may sätti-y-a-to
 Saba Obj-Det-3MSg waster PerfS.drink-SM.3FSg-OM₁.3MSg
 ‘Saba drank the water.’

The utterance with an indefinite object (287a) expresses the mere fact that Saba drank water without specifying which water is being drunk and how much of it is being drunk. On the other hand, the use of the definite object (287b) marks a discourse reading of referentiality or individuation since the definite form expresses that the speaker and the listener share information about which water is being drunk by Saba. Moreover, the utterance with the definite object does not express a semantically restricted reading, e.g. that all of the water is being drunk. In these monotransitive clauses, case marking and pronominal indexation do not differentiate objects in terms of their syntactic functions, but rather in terms of their

discourse functions. Both instances of these objects assume the same grammatical function as primary object (OBJ), but they assume different discourse functions. The indefinite/unmarked ones correspond to a focus discourse function, and the marked/definite ones to a topic discourse function.

On the other hand, in Tigrinya, when the verb bears the suffix OM₂ for the object, we get a semantically restricted reading of the object in question. In (288), the referent of the object is perceived as being partially affected.

- (288) ሳባ ነቲ ማይ ሰትያትሉ ።
 Saba n-ät-i may sätti-y-a-tlu
 Saba Obj-Det-3MSg water PerfS.drink-SM.3FSg-OM₂.3MSg
 ‘Saba drank from the water.’

Turkish expresses a similar partitive reading with the ablative case (Çetinoğlu and Butt 2008). As was shown earlier, in Tigrinya applied objects that are coded with OM₂ reflect a lower degree of affectedness than those coded with OM₁. They also reflect a contrasted semantic behavior under passivization, that is, objects coded by OM₂ resist passivization. Therefore, OM₂ marks restricted or secondary objects (OBJ_θ). As with the objects coded with OM₁, objects coded with OM₂ correspond to individuated referents, thus they are discourse topic objects. This fact indicates that semantic affectedness and discourse affectedness are grammaticalized in Tigrinya, and they are not always correlated.

8.3.4 Conclusion

The kind of asymmetrical pattern reflected in Tigrinya applicative clauses indicates that controlling a verbal suffix may not be regarded as a property of primary objecthood. Pronominal object marking has other motivations than merely identifying categories of objects in Tigrinya. Only definite and individuated referents are identified with case and pronominal marking, and these objects are accorded discourse salience. Therefore, applied objects, by virtue of their pronominal coding, are accorded a topic discourse status. However, since the semantic roles they bear are not semantically lexicalized as affected object arguments, these applied arguments are not accessible for passive expression. Thus, they are characterized as secondary patient-like arguments. Similarly, case marking in Tigrinya cannot systematically distinguish between primary and secondary objects since a core object that bears the objective case *ni-* may bear any semantic relation – theme, recipient, beneficiary, instrumental or locative. Like pronominal marking, objective case marking in monotransitive clauses arises when the object is definite. The objective

case marker serves to differentiate a topical object from a topical subject. On the other hand, when an object is more topical than the subject, it occurs clause initially, i.e. the default position of a topical subject. In this position the objective case marker becomes optional, which is a tendency observed in possessor and experiencer applicative expressions (more discussion on this is found in section 4.4.6).

Furthermore, word order cannot differentiate between objects in terms of primary and secondary functions in Tigrinya. Neither base nor applied objects are contingent on verb adjacency. When objects have the right marking conditions in terms of case and verbal suffixes, they can occur in alternative positions to code various information structures. Moreover, since relativization applies equally to both objects, it cannot be used as a diagnostic of primary and secondary objecthood, even though their extractability evidences their status as core objects. Further, the symmetry that relativization indicates in beneficiary, source and locative applicative constructions contradicts their behavior with respect to passivization. Since relativization is not sensitive to object affectedness, it applies to all core objects alike. Nevertheless, the restrictions on admitting object suffixes on relative verbs conform to restrictions on admitting object suffixes on main verbs. The clause that embeds the relative clause codes an applied object only when the relative verb bears a suffix for it. If the relative verb bears an object suffix for the theme object, then the main clause cannot code an applied object. Even with extracted theme objects, the relative verb must bear the suffix for the applied object in order for the main clause to express an applied object reading. When the relative verb bears an object suffix for a theme argument, the applied semantic role which otherwise may be expressed as an applied object, would appear as an oblique expression. Similarly, in applicative clauses the main verb obligatorily bears the applicative suffix for the applied object to give it core object status, but not necessarily primary object status.

Therefore, since passivization is the only grammatical process that is sensitive to an object affectedness, we postulate passivization to be the primary property of affected objects. Hence, objects that undergo passivization will be regarded as primary objects, and objects that do not reveal this property will be analyzed as secondary objects. In the case of symmetrical objects, since passivization cannot distinguish between the primary and secondary objects, this study concludes that the object classification OBJ and OBJ_θ cannot account for the symmetrical objects. In the following section, we will demonstrate the linking pattern of objects in Tigrinya according to the linking principles laid out in LMT.

8.4 Tigrinya applicatives according to LMT

In the previous section, we established passivization as a property of primary objecthood in Tigrinya. Passivization reveals that Tigrinya has a symmetric pattern in ditransitive applicatives and an asymmetric pattern in applicatives formed out of transitive base verbs. The symmetric applicatives typically involve recipient and goal applied objects, whereas the asymmetric applicatives involve beneficiary, maleficiary, source, locative and instrumental semantic roles, among others. In the following sections, we will demonstrate how LMT deals with the applicative patterns found in Tigrinya. Asymmetric applicatives can be straightforwardly accounted for by using the alternative linking specifications given in Alsina and Mchombo (1990:25-26) and the general principles of standard LMT proposed by Bresnan and Kanerva (1989) and Bresnan and Moshi (1990) (these are referred to in section 7.5.1, p. 222–223). However, as was pointed out earlier (chapter 7.5.3, p. 232) symmetric applicatives present a problem not only for the standard version of LMT developed by Bresnan and Kanerva (1989), Bresnan and Moshi (1990) and Alsina and Mchombo (1990) but also for the model proposed by Kibort (2004, 2007, 2008). In the following sections, we will show how LMT handles the various types of applicative patterns found in Tigrinya.

8.4.1 Linking pattern in symmetric applicatives

Symmetric applicatives contain two arguments that reflect primary patient-like properties, as they can function as subjects in passivization (this was illustrated in sections 4.4.1, 5.3.2 and 8.2.2). In Tigrinya, this pattern characterizes ditransitive applicatives that code an object with a recipient or a goal semantic role in addition to the theme object. In the standard version of LMT, semantic roles that alternate between unrestricted grammatical functions, i.e. SUBJ and OBJ, in active and passive transitive clauses receive the feature $[-r]$ as their syntactic specification. According to Alsina and Mchombo (1990) semantic roles such as recipient and beneficiary that traditionally are associated with the *indirect object* relation are semantically restricted from acquiring the alternative feature classification $[+o]$. Bresnan and Moshi (1990:72) endorse this description, and they state in a footnote that these semantic roles must appear as unrestricted because they are inherently more topical than other object roles. In Tigrinya even though this description can account for the pattern reflected in applicative clauses with a recipient and a goal semantic role, it cannot apply to a beneficiary applicative clause since beneficiary

applicatives reflect an asymmetric pattern. The beneficiary semantic role cannot be associated with the subject in passive constructions (refer to section 8.4.2 for more information on the pattern of objects in asymmetric applicatives).

Tigrinya symmetric applicatives are not adequately analyzed in standard LMT for the same theoretical reasons which we discussed in chapter 7.5.3 with regard to symmetric applicatives in languages such as Kichaga. Below (289) we give the representation for Tigrinya symmetric applicatives for the sake of illustration.

(289) a. Active ditransitive predicate

give-to/load-on	⟨	agent	theme	recip/goal	⟩
		[-o]	[-r]	[-r]	
		SUBJ	OBJ*	OBJ	

b. Passive ditransitive predicate

give-to/load-on	⟨	agent	theme	recip/goal	⟩
		[-o]	[-r]	[-r]	
		∅	SUBJ	OBJ	or
		∅	OBJ	SUBJ	

As was discussed earlier, in standard LMT, the assignment of two [-r] features for object roles (289a) is ruled out on the basis of the bi-uniqueness condition, whereas it is allowed in the passive applied predicate as shown in (289b), since one of the arguments with [-r] feature will be mapped to the subject function. Thus, according to Bresnan and Moshi (1990), in order to satisfy the bi-uniqueness condition the theme semantic role must get the alternative [+o] classification in the active applied predicate. However, this analysis contradicts the empirical evidence of theme arguments, both the fact that they passivize and also that they possess patient-like properties with respect to pronominal marking. Kibort (2008:329) assumes that her proposed extension to LMT can mend such a drawback in the analysis of symmetric applicatives. However, we argue that Kibort's analysis does not provide a proper characterization of symmetric applicatives in Tigrinya. As is illustrated in the following representation (290), in Kibort's method semantic roles change order in order to realign to the argument position that holds the correct syntactic specification in the morphosyntactic context to which they are applied.

(290) Kibort's symmetric applicative

<i>agent</i>	<i>goal</i>	<i>theme</i>
<i>agent</i>	<i>recip</i>	<i>theme</i>
<i>agent</i>	<i>theme</i>	<i>goal</i>
<i>agent</i>	<i>theme</i>	<i>recip</i>
⟨ <i>arg</i> ₁	⟨ <i>arg</i> ₂	⟨ <i>arg</i> ₃ ⟩
[-o]	[-r]	[+o]
SUBJ	OBJ	OBJ _θ

Either the theme or the recipient/goal semantic role can map to the argument position specified as [-r]. However, it should be noted that since the model does not allow two positions to be simultaneously specified as [-r] in a given morphosyntactic context, whenever one of the object semantic roles maps to the unrestricted position [-r], the other one is restricted to map to the second object position specified as [+o]. According to this model, the two objects cannot show primary object properties simultaneously. Therefore, Kibort's model cannot adequately represent symmetric applicatives in Tigrinya. In fact, Kibort does not provide examples to show in which morphosyntactic contexts (the recipient/beneficiary and the theme map to [-r] and [+o] argument positions, respectively, and vice versa) such representations can be applicable. Moreover, it is not clear why the two object roles in symmetric applicatives should alternatively map to the [+o] function, even though both of them simultaneously reflect a patient-like property. Aligning either of the semantic roles to the [+o] description is not empirically motivated in symmetric applicatives such as those found in Tigrinya. For this reason, as with standard LMT, the representation proposed by Kibort cannot adequately characterize symmetric applicatives in Tigrinya.

8.4.2 Linking pattern in asymmetric applicatives in LMT

In Tigrinya, double constructions that involve a beneficiary, a maleficiary, a source, a locative or an instrumental applied object reveal asymmetric properties. Even though the object that corresponds with these applied roles is obligatorily marked on the verb through the suffix OM₂, these semantic roles cannot be associated with the subject in the passive. Furthermore, the fact that they employ a different pronominal suffix type than is associated with theme and recipient objects (OM₁), suggests that they do not reflect a prototypical patient-like property. For this reason, these

applied roles get the restricted [+o] specification, whereas the theme role in these constructions gets the unrestricted [-r] specification, since they reveal a patient-like property by being able to be associated with the subject in a passive clause. The linking pattern of these asymmetric applicatives is shown in (291).

(291) a. Applied active predicate

V	⟨	agent	theme/exp	ben/mal/loc/instr	⟩
		[-o]	[-r]	[+o]	
		SUBJ	OBJ	OBJ _θ	

b. Applied passive predicate

V	⟨	agent	theme/exp	ben/mal/loc/instr	⟩
		[-o]	[-r]	[+o]	
		∅	SUBJ	OBJ _θ	

As was mentioned earlier, it should be noted that Bresnan and Moshi (1990:72) propose that the beneficiary and the recipient roles cannot be specified with the [+o] classification. They assume that since these arguments inherently have topical and individuated referents, they occupy a higher position in the topicality/thematic hierarchy. However, this cannot apply to applied beneficiaries in Tigrinya. Applied beneficiaries are not initial arguments of the main verb, but nevertheless they are related to it pragmatically or through the discourse context, and therefore are expressed as a topical element in the discourse. Yet since they do not code a protopatient property that allows them to passivize, they cannot be analyzed as primary objects. Only the theme argument possesses this property. This asymmetric pattern shows that discourse prominence may not necessarily correlate with semantic prominence, as was discussed in sections 5.3 and 5.3.1. In Tigrinya, the notion of affectedness is rooted in the lexical semantics of the verb. Only arguments that register the magnitude of changes associated with the event described by the verb are perceived as prototypically affected objects. On the other hand, beneficiary, source, locative or instrumental arguments control verbal suffixes not because they code a more patient-like property than the theme argument, but because they are expressed as prominent participants in the discourse. The same syntactic specification [+o] is given to the applied roles in the passive representation (291b), and thus they are always linked to restricted objects (OBJ_θ).

Interestingly, passive predicates that code such applied arguments reflect a similar pattern to that of applicatives that involve unaccusative base verbs. In both constructions, applied arguments cannot be associated with the subject in the passive. Moreover, the two predicates can alternatively allow the suffixes OM₁ and OM₂ to express implicatively affected and ethically affected readings of the applied object, respectively. For example, transitive predicates such as ኣንበረ ጎanbärä ‘he placed/put/set’ and ቀረጸ qoräsä ‘he cut’ can only allow the suffix OM₂ to code an applied object, as in ጎanbir-u-la ‘he put on it.F’ and qoriṣ-u-la ‘he cut with/from it.F’ (this pattern of coding is summarized in Table 5.1). In contrast, their respective passive forms, such as ተንበሩ-ላ/ዋ tä-näbir-u-la/wa ‘It has been put on it.F’ and ተቀረጹ-ላ/ዋ täqoriṣ-u-la/wa ‘it has been cut with/from it.F’, allow either OM₁ or OM₂ with different readings of affectedness. The object coded with OM₁ is perceived as being directly or implicatively affected, whereas the object coded with OM₂ is understood as being incidentally or ethically affected. Similarly, applicative predicates formed out of unaccusative verbs can allow either of the suffixes to make a comparable semantic distinction. Nevertheless, although these applied arguments are perceived as directly affected objects, and are coded through the suffix OM₁ since they are not inherently lexicalized patient arguments of the base verb, they are specified as restricted [+o] arguments. The linking pattern of applicatives with intransitive bases is given the following section.

8.4.3 Linking pattern in applicatives of intransitive bases

Applied arguments that are added to intransitive applied predicates can get either the [-r] or [+o] specification. Usually, it is assumed that applied arguments of unaccusatives cannot undergo passivization, whereas applied arguments of unergatives can. In Tigrinya, there is a certain class of unaccusative verbs that can be coded as passive predicates, but since the state that the applied argument undergoes is not brought about or caused by the action of an agent, the applied semantic roles cannot be expressed as subjects. The passive predicate of such verbs bears a subject suffix for an impersonal subject and an object suffix for the applied object. There are also certain unaccusative predicates that cannot be passivized at all. These do not have passive predicate forms. On the other hand, unergative verbs can be passivized, but not all unergative verbs can express applied arguments as subjects in the passive. Applied predicates that are formed out of unergative predicates that lexicalize agent-like participants and applied participants that have a characteristic of affectedness can be passivized, and thus can express the applied arguments as subjects in

the passive. Mostly, applied arguments coded by unergative predicates of motion verbs can undergo passivization. However, unergative predicates that code participants that perform actions or undergo states that only involve themselves, cannot code applied arguments as subject in passivization. For more discussion on this topic refer to section 5.3.2, p. 150.

Unaccusative applied predicates such as ደቂሱዋ/ላ *däqis-u-wa/la* ‘He slept on her’, መደቱዋ/ላ *mäyit-u-wa/la* ‘He died on it[fem]/for her’, ወዲቹዋ/ላ *wädiq-u-wa/la* ‘it has been fallen upon/on/for’, ፈሊሱዋ/ላ *falih-u-wa/la* ‘it boiled on/for her’ and መጠኑዋ/ላ *mäkik-u-wa* ‘it melted on/for her’ may bear the object suffixes *-wa* or *-la*, which in this study are designated as OM₁ and OM₂, respectively. Depending on the semantics of the unaccusative verb it attaches to, OM₁ may code an affected goal, or it may code an ethically affected applied object which bears a maleficiary semantic role. On the other hand, OM₂ expresses a mere beneficiary, source, locative or instrumental semantic role reading without indicating that these are in some way affected. An active applied predicate with an unaccusative base verb codes a patient-like argument as a subject, and applied arguments as objects. Bresnan and Zaenen (1990:52) propose that the basic patient-like argument of the unaccusative verb gets the [-r] syntactic classification to enable it to map to the subject, similar to the pattern of a passive predicate. On the other hand, since normally the applied argument does not link to the subject in a passive, the applied semantic roles of an unaccusative base verb are specified as [+o] so that they are associated to a restricted object (OBJ_θ), as is shown in (292).

(292) Unaccusative active applied predicate

V	{	theme	ben/mal/loc/instr	}
		[-r]	[+o]	
		SUBJ	OBJ _θ	

Unaccusative verbs such as ደቀሱ *däqäsä* ‘he slept’ and መወተ *mäwätä* ‘he died on/for her’ which code a sentient experiencer argument have passive predicate forms. However, the passive counterparts ተደቂሱዋ/ላ *tä-däqis-u-wa/la* ‘it has been slept on it’ and ተመደቱዋ/ላ *tä-mäyit-u-wa/la* ‘it has been died for her’ cannot express an applied argument as a subject. The subject marker in these predicates corresponds with an athematic subject, i.e. a null ‘pro’ subject. Sometimes, the subject suffixes in these predicates can correspond to a cognate subject argument, as in ‘Sleep has been slept on it’ or ‘Death has been died for her’. Yet since most cognates

are usually indefinite elements, they do not overtly appear in the active unaccusative clause. However, in the passive clause they appear as placeholders of the subject argument position. The original subject argument, i.e. the person that sleeps or dies, remains unexpressed or is suppressed by the passive operation. The object verbal suffix corresponds with the applied object. The applied object may bear a beneficiary, a maleficiary or a locative semantic role depending on the semantics of the base verb. Such clauses stylistically express sarcasm or irony. Unaccusative verbs that code arguments with referents that have the ability to affect others, such as **ወዲቹ** *wädiq-u* ‘He/it fell’ behave like unergative verbs. In the passive **ተወዲቹ** *tä-wädiq-u* ‘he has been fallen upon’, the subject suffix corresponds with the applied argument. The applied argument is perceived to undergo a state that is caused by an agent-like argument, as in ‘**ብወተገድራት ኣደጋ ተወዲቹ** *bi-wätähadärat hadäga tä-wädiq-u* ‘he has been ambushed (attacked) by soldiers’. We propose that such predicates be treated like unergative predicates. The mapping pattern of the applied object of unergative applicatives is schematically shown (294b). However, passive forms of unaccusative verbs that code non-sentient arguments, as in ***ተፈሊሑ** *tä-fälīh-u* ‘it has being boiled’⁷, ***ተመኸኸ** *tä-mäḳik-u* ‘it has been melted’ are not allowed in the language. In (293) we illustrate the linking pattern of passivized unaccusative predicates.

(293) Unaccusative impersonal passive applied predicate

V	-	⟨	theme/exp	ben/mal/loc/instr	⟩
[-r]			[-r]		[+o]
SUBJ			∅		OBJ _θ

Tigrinya does not have an impersonal pronoun like the English *it*. Impersonal subjects are coded through the third person masculine singular subject suffix. Therefore, we analyze the subject suffix of these predicates as marking an impersonal subject. It supplies the agreement values for a null ‘pro’ subject, as is the case in pro-drop languages. Since the argument coded with the subject suffix does not correspond to any of the semantically (i.e. a theme) or morphosyntactically (i.e. an applied argument) entailed arguments of the unaccusative predicate, it is specified with the [-r] feature, a specification which is assigned to athematic arguments. Since athematic arguments are semantically vacuous, they cannot be listed within the argument structure together with the semantically meaningful arguments (Bresnan 2001:309). Thus, as the representation in (293) shows, the nature of a non-

⁷‘boil’ is not in the causative form, thus cannot reflect a causative reading here.

thematic argument is signaled by representing it outside the argument structure, i.e. outside the angled brackets. In this representation, the initial argument of the unaccusative verb is suppressed, and since the applied object cannot be mapped to the subject in passivization, it is given the [+o] specification so that it appears as a restricted object OBJ_{θ} .

As was discussed in section 5.3.2, unergative applied predicates such as **ሓንቢሱላ** *hanbäs-u-la* ‘He swam for/in/with/for her/it.F’, **አጣቺዑላ** *ʔaṭaqiʕ-u-la* ‘He clapped with/for her/it.F’, **ፋጺዩላ** *faṣäyā* ‘He whistled at/with/for her/it.F’, **ሰጊዱላ** *sägäd-u-la* ‘He bowed at her’ admit applied objects through the suffix OM_2 , and since they cannot semantically lexicalize an affected applied object, they do not allow the suffix OM_1 . When these predicates are passivized, as in **ተሓንቢሱላ** *tä-hanbäs-u-la* ‘It has been swum for/in/with/for her/it.F’, **ተአጣቺዑላ** *tä-ʔaṭaqiʕ-u-la* ‘It has been clapped with/for her/it.F’, **ተፋጺዩላ** *tä-faṣäyā* ‘It has been whistled at/with/for her/it.F’, **ተሰጊዱላ** *tä-sägäd-u-la* ‘It has been bowed at her’, the subject suffix codes an impersonal subject similar to the unaccusative passives we discussed above. On the other hand, the applied object is expressed through the applied object suffix (OM_2) on the passive predicate, and thus it holds the feature [+o] to allow it to be linked with a restricted object only, whereas the initial argument of these unergative predicates get the [-o] specification which is typical of agent-like arguments. The following representation illustrates the mapping pattern of active (294a) and passive (294b) unergative applied predicates.

(294) a. Mapping in unergative applied predicate

V	⟨	agent	ben/mal/loc/instr	⟩
		[-o]	[+o]	
		SUBJ	OBJ_{θ}	

b. Mapping in passive unergative applied predicate

V	–	⟨	agent	ben/mal/loc/instr	⟩
	[-r]		[-o]	[+o]	
	SUBJ		\emptyset	OBJ_{θ}	

In contrast, unergative verbs such as **ሰሐቺዋላ** *siḥiṕ-u-wa/la* ‘he laughed at/about/with her/it.F’, **ገዩዋላ** *goyyiy-u-wa/la* ‘he ran after/for/with/on’, **መጸኡዋላ** *mäsi ʔ-u-wa/la* ‘he came to/for her’, **በጸሐዋላ** *bäsiḥ-u-wa/la* ‘he arrived at/for her/it.F’ and **ከዩዋላ** *kä(yä)d-u-wa/la* ‘he went to/for her’ can code a patient-like

applied argument to express a goal semantic role through the suffixes OM₁. These goal arguments are specified as [-r], which allows them to alternate between an object and a subject in active and passive clauses, respectively. On the other hand, semantic roles such as beneficiary, maleficiary, locative, instrumental and reason, that can be applied through the suffix OM₂ to these unergative verbs, cannot appear as subjects in passive predicates. Thus, these unpassivizable roles are specified as [+o], and they reflect the unergative pattern given in (294a). Passivizable unergative applicatives are modeled as in (295).

(295) a. Active unergative applied predicate

V	⟨	agent	goal/patient	⟩
		[-o]	[-r]	
		SUBJ	OBJ	

b. Passive unergative applied predicate

V	⟨	agent	goal/patient	⟩
		[-o]	[-r]	
		∅	SUBJ	

As the discussion above shows, object variability in intransitive applicatives results from the semantic property of the initial argument of the base verb and the nature of the event that the verb codes. In other words, it is not enough to have an agent-like argument in order to code an affected applied object. The event involved or the action that the agent-like argument performs must also be transferrable or transmittable to affect the applied object argument. This is reflected, for instance, in the distinction between unergative predicates such ሳዕሲዮ-ላ/*ፆ saʿsiʿi-u-la/*wa ‘he danced on/for her/it.F’ and ስሐቆ-ላ siḥiq-u-wa/la’ ‘he laughed at/about/with her/it/F’. With the former verb the event is not transferrable, and thus the verb cannot code an undergoer goal applied argument. Thus, the meaning **he danced at her* is blocked, whereas since in with latter verb the event is transmittable, the verb can code an undergoer applied object to express the sense *he laughed at her*.

8.5 Conclusions

In this chapter, we have discussed morphosyntactic properties of applied objects with respect to various object diagnostics. We have considered some of the standard object diagnostics, such as word order, case marking, pronominal object suffixes, passivization, relativization and clefting to determine the grammatical status of objects in applicative double object constructions. It is assumed that the object that is primarily implicated in these grammatical processes has the status of primary object. After analyzing applicative clauses that result from different verb classes, however, we have found that only passivization shows a significant contrast between objects. Word order appears to be governed by information structure constraints. Grammatical functions are ordered according to their discourse prominence from left to right. Switching the order of objects affects neither the grammaticality of the clause, nor the grammatical function status of the object, but it changes the information structure reading of the grammatical functions. When the various grammatical functions are coded distinctly in terms of case and pronominal object suffixes, they can leave their default position in order to render various pragmatically marked readings. This tendency indicates that the primary and secondary grammatical status of objects cannot be determined on the basis of their relative position with respect to the verb, since verb adjacency is not a property of primary objecthood in Tigrinya. Moreover, we have also argued that case marking and verbal affixation of objects do not signal the primary and secondary functions of objects, although they do confirm their core object status. Similarly, since both objects, in applicative double object constructions can be relativized and clefted, these diagnostics cannot help to identify primary and secondary objects in Tigrinya.

Passivization reveals that Tigrinya has both symmetrical and asymmetrical applicative constructions. Double object constructions that involve prototypical ditransitive verbs such as *give*, *distribute*, *teach* and *tell* involve symmetrical objects. In these constructions the two objects exhibit the morphosyntactic behavior of a single object of a monotransitive clause. In section 8.4.1, we noted that symmetric applicatives pose a problem for LMT, both the standard version developed by Bresnan and Kanerva (1989), Bresnan and Moshi (1990), Alsina and Mchombo (1993) and Bresnan (2001) and the extended version proposed by Kibort (2007, 2008). According to the analysis given by Bresnan and Moshi (1990), even though in principle the two semantic roles that are associated with objects in symmetric applicatives can be assigned a [-r] feature in order to allow them to be linked to a

subject in passive predicates, since the assignment of two [-r] features to semantic roles would violate the biuniqueness condition, this is ruled out in practice, and instead the theme/patient semantic is assigned the [+o] on an *ad hoc* basis.

In her revised version Kibort (2008) suggested that syntactic specifications should be assigned to fixed positions in the argument structure window (see (238)), instead of to individual semantic roles. In this way, her model does not posit the universal thematic role hierarchy as a principle in linking semantic roles to grammatical functions. Instead, she proposes that the argument slots in the argument structure should be ordered according to the markedness hierarchy of grammatical functions, as shown in (217). In this way, semantic roles will freely align to grammatical functions that bear the right syntactic feature specification in a given morphosyntactic context. Nevertheless, as we have pointed out earlier, this proposal does not solve the issue of symmetric objects in Tigrinya ditransitive clauses. As we can see from the assignment of the syntactic specification in (238), only one object position gets the [-r] feature, and thus the semantic roles that correspond to objects can be associated with this position only alternatively. Such an analysis does not reflect the syntactic properties that objects show in symmetric applicatives. Since, according to passivization, both object semantic roles reflect patient-like properties, it remains unclear which of the semantic roles link to which position, to [-r] or [+o]. In Kibort's model these semantic roles seem to be linked to either [-r] or [+o] in an arbitrary fashion.

In this study, we do not intend to suggest a revision to the binary feature decomposition method employed in LMT in order to accommodate symmetric applicatives. We agree with Börjars and Vincent's (2008) observation that "Failing a genuinely viable proposal involving different features, for the present we conclude that the way forward is not to be found by devising new binary feature sets." However, the different coding patterns that identify symmetrical objects can be implemented by using the general constraint specifications system in LFG. The different conditions under which objects are coded can be stated as constraints to identify objects in symmetric applicatives. As we shall see in chapter 10, the two objects are identified as OBJ and OBJ_{goal}, and these are associated with the theme argument and the recipient argument, respectively. The two objects can be assigned the affectedness property, and at the same time their distinctness can be stated through constraints. This is possible because in XLE, the computational platform for implementing LFG grammars, enables complex interaction of constraints declared at different levels of the grammar. In this way, we can state that OBJ_{goal} is associated

with a passivizable argument via a lexical rule, and at the same time retaining its semantic contentfulness. Therefore, in our analysis, we do not assume that OBJ_{goal} is an instance of OBJ_{θ} . We wish to propose a third category of object that does not reflect semantic affectedness, and therefore does not passivize. This object category is identified as OBJ_{appl} .

The second type of applicative construction codes asymmetric objects. In these constructions, only one object, i.e. the base object, exhibits the morphosyntactic property of the single object of a monotransitive clause. This type of asymmetry is uncommon, since what is expected is that the applied object has a primary object property, whereas in Tigrinya it reflects a secondary object property. The applied object can bear a beneficiary, a locative, a goal, a source or an instrumental semantic role. These semantic roles will never be associated with the subject in passive clauses. Therefore, according to pronominal marking, the applied object would be considered the primary object in these applicative types, but because these cannot be passivized we consider them to be linked to a restricted object (OBJ_{θ}). Based on these observations, we have argued that pronominal object marking in Tigrinya indicates the topical status of objects, rather than identifying them as primary or secondary objects. The fact that the applied object is cross-referenced on the verb demonstrate that it functions as a core object, and thus cannot be analyzed as an oblique. The only diagnostic that consistently indicates the affectedness of objects is passivization, and with respect to this, only the theme argument assumes a primary object function. Therefore, we propose that in Tigrinya the applied object of asymmetric applicative clauses is analyzed as a restricted object.

CHAPTER 9

Object topicality and DOM in Tigrinya

9.1 Introduction

In chapter 6 we observed that applicatively expressed discourse participants possess a higher degree of salience than their obliquely expressed counterparts. In this chapter, we will elaborate on the discourse properties of applied arguments discussed in (Nazareth 2007). We will discuss applicative coding in relation to Differential Object Marking (DOM) Nazareth (2008). We maintain that the criteria that determine DOM in monotransitive clauses also determine object marking in double object and applicative clauses. In Tigrinya when a double object clause involves two definite objects that display similar affectedness properties, either of the objects can be indexed on the verb depending on which participant is topical in the discourse context. In applicative clauses formed out of transitive bases applied objects are prioritized for verbal indexation since they correspond to salient referents in the discourse. This behavior indicates that DOM is motivated by discourse salience.

We will adopt the theory of DOM and information structure proposed by Dalrymple and Nikolaeva (2005, 2007, 2011) in order to account for the topicality of objects in double object and applicative clauses. Dalrymple and Nikolaeva maintain that there is a correlation between grammatical functions and information structure roles. Based on their observation of data from Ostyak and Chatino, they argue that

topical objects assume primary object (OBJ) status, whereas the non-topical (focus) objects are associated with secondary objects (OBJ_θ). However, Tigrinya appears to be different from these languages in the way grammatical functions are associated with a topic role in information structure. As was illustrated in 8.3.2, in asymmetrical applicative constructions, applied objects do not reflect primary patient-like properties, but they are prioritized for verbal indexation since they correspond to most salient discourse participants.

This chapter will be organized in the following way. In section 9.2 the concept of DOM will be presented, and it will be illustrated by examples from different languages. In section 9.3 we will discuss factors that are assumed to motivate DOM. In section 9.4 we will show the pattern of alignment between marked objects and topic information structure roles in clauses that involve ditransitive, transitive and intransitive base verbs. Finally, in section 9.5 we will give some concluding remarks.

9.2 Differential Object Marking

Differential Object Marking is a designation given to the phenomenon where objects are variably marked (Comrie 1979, Khan 1984, Bossong 1985, 1991, Croft 1988, Aissen 2003, Næss 2004). The term was first used by Bossong (1985) in his investigation of the phenomenon in Romance and Semitic languages. However, the phenomenon itself had been discussed previously in relation to a wide range of unrelated languages long before Bossong. For example, it was noted by Gair (1970) in reference to Sinhalese (in which only animate objects are case marked), by Comrie (1977) in reference to Uralic languages, by Givón (1978) in reference to Hebrew (in which only definite objects are obligatorily case marked), by Farkas (1978) in reference to Romanian (in which only pronouns and proper nouns referring to animate entities acquire case marking), and by Khan (1984) in reference to several Semitic languages which employ case marking and/or pronominal indexation to mark discourse prominent objects which may correspond to animate, definite or specific referents depending on individual languages. Khan notes that in Amharic, a language closely related to Tigrinya, definiteness and discourse prominence trigger case and pronominal marking in direct objects. Morimoto (2002) observes that in Bantu languages animacy and definiteness/specificity determine pronominal marking of objects.

Some studies indicate that the motivation for DOM goes beyond the mere mark-

ing of the semantic features humanness, animacy, definiteness or specificity. For instance, Khan (1984:470) observes that object markers in Semitic languages are conditioned not only by the inherent individuation or salience status of the nominals that code object referents, but also by the discourse status of the clause that contains them. Dalrymple and Nikolaeva (2005, 2011) express a similar view in a recent study that proposes an information structure approach to DOM. They maintain that marked objects are associated with the information structure role of **topic** and unmarked objects with **non-topic** (2011:14). Most of the time, the semantic features (animacy, definiteness, and specificity) that are associated with marked objects tend to characterize topic objects as well. Languages may employ case marking and/or pronominal indexation to code objects with such semantic features. Below we give examples from languages that employ either case marking, pronominal indexation, or both strategies for DOM. The Turkish example (296) shows that a noun phrase bears an accusative case marker *-u* when referring to a definite object (296a), and is unmarked when referring to an indefinite object (296b).

(296) Turkish: accusative case with definite objects (Comrie 1989:132)

a. *definite object*

Hasan öküz-**ü** aldı
 Hasan ox-**Acc** bought
 ‘Hasan bought the ox.’

b. *indefinite object*

Hasan bir öküz aldı
 Hasan a ox bought
 ‘Hasan bought an ox.’

The Swahili example in (297) illustrates that an animate object triggers pronominal indexation on the verb (297a), while an inanimate object does not produce such an effect (297b).

(297) Swahili: Verbal indexation with animate objects (Vitale 1981:123-124)

a. *animate object*

Juma a-li-**m**-piga risasi tembo jana usiku.
 Juma SM-PAST-**OM**-hit bullet elephant yesterday night
 ‘Juma shot an/the elephant last night.’

b. *inanimate object*

risasi i-li-piga mti karibu na sisi.
bullet SM-PAST-hit tree near us
'The bullet struck the tree near us.'

Amharic employs both case marking and pronominal indexation to mark definite objects. Amberber (2005) notes that the accusative case is obligatory with definite objects, but the object pronominal marker is optional.

(298) Amharic: case and pronominal indexation with definite objects Amberber (2005:298-299)

a. *definite object*

lämma țärmus-u-**n** säbbär-ä(-**w**)
Lemma bottle-DEF-ACC Perf.break-SM.3MSg(-OM.3MSg)
'Lemma broke the bottle.'

b. *indefinite object*

lämma ?and țärmus säbbär-ä
Lemma one bottle Perf.break-SM-3MSg
'Lemma broke one/a bottle.'

Khan (1984:472) gives a slightly different account of case marking in Amharic. In the Biblical texts he analyzed, he notes that case marking is obligatory only when the noun phrase is formally determined and is associated with textually and discourse prominent referents. Further, it occurs more frequently with human referents than with non-prominent inanimate referents. Moreover, he observes that, in Amharic, verbal indexation is optional with non-finite verbs (e.g. gerundive or converbs), but it is obligatory with 'peak' verbs.¹

In Tigrinya DOM is determined by definiteness/specificity. Pronominal indexation and case marking can occur simultaneously as in Amharic. In (299a) the definite object is case marked *n-*, and also indexed on the verb *-to*, whereas the indefinite object is unmarked (299b).

(299) Tigrinya: case marking and verbal indexation

a. *definite object*

አታ	ላም	ነቲ	ብሶራይ
ʔit-a	lam	n-ät-i	biʔray
Det-3FSg	cow.FSg	Obj-Det-3MSg	bull.MSg

¹Peak verbs are described as finite verbs that express the culmination of events or actions, or close a chain of events or actions in a clause (Khan 1984:484).

ርእያቶ ።

riʔy-a-to.

perfS.see-SM.3FSg-OM₁.3MSg

‘The cow saw the bull.’

b. *indefinite object*

እታ ላም ብዕራይ ርእያ ።

ʔit-a lam biʕiray riʔiy-a.

Det-3FSg cow.FSg bull.MSg perfS.see-SM.3FSg

‘The cow saw a bull.’

In some constructions, including the possessive and experiencer verb constructions, the case maker (objective case) becomes optional, as was discussed earlier (see 4.4.6, and p. 383 and 385 in section 10.6.3). In these constructions the object obligatorily appears in clause initial position. In Tigrinya this tendency is observed when the object referent is more semantically prominent than the subject referent, and when the subject is athematic and the object is the only referential and salient entity. This tendency is similar to the object-subject reversal construction that Morimoto (2009) identifies in Kinyarwanda and Kirundi.

Most previous studies discuss DOM in connection with case marking. Moreover, they treat it with reference to the direct or accusative object of a monotransitive clause (Comrie 1979, Khan 1984, Bossong 1985, Croft 1988, Aissen 2003, Næss 2004). Dalrymple and Nikolaeva’s (2011) approach is exceptional because their investigation of this phenomenon also covers objects in double object and applicative clauses, and includes case-marking and verbal indexation.

9.3 The function of DOM

In functional typological literature there are alternative views concerning the function of DOM. Some propose that DOM has a discriminatory function which is motivated by the need to distinguish between an object and a subject, for example, when an object reflects prominence properties (animacy/definiteness) that are not typical of an object, but are inherently present in a subject (Van Valin 1992). Others assume that DOM via case marking has an indexing or coding function that aims to indicate a property that the marked object possesses, and the unmarked object lacks. However, these views have little to say about the function of DOM manifested via pronominal indexation or through both case marking and pronominal indexation.

In functional typological research it is assumed that DOM, especially when it involves case-marking, has a discriminatory function in the sense that it serves to

mark object arguments with semantic properties (e.g. animacy and definiteness) which are typical of subjects (Comrie 1975, 1977, 1979, 1989, Silverstein 1976, 1981, Aissen 2003). Normally, in a default clause where subjects and objects are unmarked, subjects are associated with arguments that are high in prominence features, whereas objects are associated with arguments that are low in prominence features. According to this view, DOM signals a deviation from the norm or from the prototype. In line with this perspective, Aissen (2003) formulates an optimality theory model to capture the markedness pattern that characterizes this phenomenon. Her analysis predicts the relative markedness of objects based on the degree of prominence on the dimensions of animacy and definiteness (300).

(300) a. Animacy Scale (Aissen 2003:442)

Human > Animate > Inanimate

b. Definiteness Scale (Aissen 2003:444)

Pronoun > Name > Definite > Indefinite Specific > NonSpecific

These animacy and definiteness scales indicate that the higher a direct object occurs in the hierarchy, the more likely it is to be case marked. Here, the emphasis is on the correlation between grammatical functions and the semantic conditions that induce grammatical marking. Aissen characterizes the type of relationship where subjects are likely to be high in prominence and objects are low as “markedness reversal”. It denotes that the semantic features that are marked for subjects are unmarked for objects, and vice versa. The relative markedness of grammatical functions is expressed through “harmonic alignment” of the relational hierarchy (given in 300) either on the animacy or the definiteness dimension. For example, the harmonic alignment for the definiteness features (300b) is schematized in (301).

(301) Aissen (2003:445)

*Su/Pron >> *Su/Name >> *Su/Def-Spec >> *Su/Non-spec
 *Obj/Non-spec >> *Obj/Def-Spec >> *Obj/Name >> *Obj/Pron

In the harmonic alignment, each element in the hierarchy of grammatical functions is associated with each element in the hierarchy of animacy/definiteness to generate sub-hierarchies which express the relative markedness of each such association. Thus, the double arrows represent the harmonization/association of the two dimensions on the basis of which the sub-hierarchies are generated. The asterisks indicate markedness constraints. For instance, in this harmonic alignment the most

highly ranked constraints ban pronominal subjects and nonspecific objects from being overtly marked, for example, for morphological case. This diagram shows that subjects positioned on the left-most edge of the hierarchy are more marked than those at the right-most edge, while the opposite holds for objects. The main point behind such a representation of DOM is to underline the function of grammatical marking, i.e. in order to differentiate subjects from objects. Consequently, since definite objects are functionally similar to subjects in terms of prominence, they carry grammatical marking that contrasts them with subjects.

Næss (2004:1190) argues that Aissen's analysis of DOM in terms of markedness reversal contradicts the established notion of transitivity, as well as some basic assumptions of markedness theory. Næss (2004, 2007) proposes a notion of transitivity consistent with that maintained by Hopper and Thompson (1980) which was also discussed earlier in this work (see p. 141, chapter 5.2). According to this view a prototypical transitive clause is one which involves a highly affected object, and unlike the analysis given by functional typologists, this is considered as the prototypical object. Næss (2004:1191) considers this notion of transitivity as crucial to the definition of direct objects which are regarded as being affected by a verbal action. Following Hopper and Thompson, she argues that there is a correlation between affectedness and individuation, as an action can be transferred more effectively to an individuated referent than to a non-individuated one. The reason that animate, definite or specific objects tend to attract grammatical marking is that these have highly individuated referents, and thus are highly affected.

However, Næss recognizes that regarding marked objects as prototypical objects in turn conflicts with standard markedness theory (2004:1192). In order to settle this conflict she proposes that DOM should be regarded as marking affectedness by involvement in the verbal event, and not individuation as manifested by definiteness or animacy (2004:1202). Næss claims that Aissen's theory of markedness reversal applies only when participants are defined in relation to the verbal event (2004:1210). According to Næss, the properties that characterize the relation of the unmarked subject and the unmarked object in a prototypical transitive construction are the following: an unmarked subject is controlling and non-affected and an unmarked object is affected and non-controlling. She states that a deviation from this pattern is reflected in the formal coding, for example, manifested by DOM. Næss further assumes that affectedness is the basic property of unmarked objects by virtue of their involvement in the verbal event.

Therefore, in our view the kind of affectedness property that DOM is signal-

ing in marked objects has to be different from that of basic affectedness. If the unmarked object is considered as being affected without implying that it lacks semantic properties such as animacy and definiteness, it means that objects are inherently perceived as being affected because of the transitive entailment of the verb. Consequently, DOM cannot be taken as indicating variation in object affectedness. On the other hand, if we consider affectedness as a matter of degree or gradience, it would mean that affected unmarked objects are less affected than marked affected objects. Næss seems to imply this, since she assumes that formal marking does not imply functional marking (e.g. definiteness), and thus formally marked objects are highly affected/individuated prototypical objects. The manifestation of DOM in Tigrinya suggests the need to distinguish between inherent affectedness and individuation. Let us consider the contrast between the formally unmarked and marked object in Tigrinya (302).

- (302) a. **ገንዘብ ወዲኡ ።**
 gänzäb wädi?-ä
 money Perf-finish-SM.1Sg
 ‘I ran out of money./Lit. I finished money.’
- b. **ኣት/ነት** (ገንዘብ) **ገንዘብ**
 ?it-i/n-ät-i (zi-hab-ka-nni) gänzäb
 Det-3MSG/Obj-Det-3MSG (Rel.perfH.give-SM.2MSG-OM₁.1Sg) money
ወዲኡ ።
 wädi?-ä-yo
 Perf-finish-SM.1Sg-OM₁.3MSG
 ‘I finished/used up the money (which you gave me).’

The transitive clause in (302a) codes two participants, the pronominally expressed first person subject and the object argument *gänzäb* ‘money’. The object argument is understood as affected by the verbal action since the money that the speaker owned before is no longer available to him/her. The speaker is not informing the addressee about some specific money that he/she identifies from earlier discourse. Thus, it is a kind of generic expression. However, the clause with the marked object (302b) is about some certain money that the addressee can identify. The relative clause modification makes the identifiability of the object referent to the addressee even more explicit. The verb *wädi?ä* ‘he finished’ cannot express a partitive or partial affectedness reading (in the sense that the money is not all used up). The partitive reading is incompatible with the meaning denoted in this verb. Therefore, the objects cannot be contrasted in terms of affectedness to say that the

unmarked object (302a) is affected, but the marked object is even more highly affected (302b). The difference that DOM is indicating is the relative salience in terms of object individuation in the discourse context, but also, interestingly, the objective case marker become optional with the relativized object, which signals its greater discourse salience in this clause.

We noted in chapters 4.4.5 (page 288) and 8.3.3 that Tigrinya expresses partial-affectedness by means of the suffix OM₂ when the semantics of the verb is compatible with the partitive reading. Usually this reading is possible with verbs that allow allative semantics; for example, **ወሲዱሉ** *wäsid-u-lu* ‘he took from it/him’ in contrast to **ወሲዱዎ** *wäsid-u-wo* ‘he took it/him’, **በሊዑሉ** *bäliŋu-lu* ‘he ate from it’ in contrast to **በሊዑዎ** *bäliŋu-wo* ‘he ate it’, and **ሰትዩሉ** *sätyu-lu* ‘he drank from it’ in contrast to **ሰትዩዎ** *sätyu-wo* ‘he drank it’. This constraint is illustrated in (303).

- (303) a. **ነቲ** **ገንዘብ ወሲዱሉ ።**
 n-ät-i gänzäb wäsid-u-lu
 Obj-Det-3MSg money Perf.finish-SM.1Sg-OM₂.3MSg
 ‘I took from the money.’
- b. **ነቲ** (**ዝሃብኒኒ**) **ገንዘብ**
 nät-i (zi-hab-ka-nni) gänzäb
 Obj-Det-3MSg (Rel.PerfH.give-SM.2MSg-OM₁.1Sg) money
ወሲዱዎ ።
 wäsidu-u-wo
 Perf-finish-SM.1Sg
 ‘I took the money (which you gave me).’

Therefore, in Tigrinya degree of affectedness is expressed by means of the two types of verbal suffix forms, rather than through the contrast between the unmarked and the marked forms. The object indexed through OM₁ is perceived to be more affected than the one indexed through OM₂. The phenomenon of marking partial vs. total affectedness by means of different markers is not unique to Tigrinya. Çetinoğlu and Butt (2008) discuss a type of differential coding in Turkish which resembles the degree of affectedness expressed by the two suffix forms in Tigrinya. In Turkish objects of psych verbs marked with dative case express partial affectedness, and objects of verbs of consumption marked with the ablative case express high affectedness.

Functional typology studies suggest an alternative interpretation of DOM which considers case marking as an indexing/coding function. Case markers are taken to be coding a specific semantic reading of an argument. According to De Hoop and

Narasimhan (2005) this applies to both inherent case (prepositional) markers and structural case (nominal) markers. They say, for example, that the dative case tends to mark goal and experiencer arguments, the ergative marks volitional or controlling arguments, and the accusative marks patient arguments. According to Hopper and Thompson (1980), DOM featured by case marking signals individuation or high transitivity property. However, De Hoop and Narasimhan (2005:323) also note that case marking plays both roles (i.e. discriminatory and indexing) in many languages. Based on this observation, they propose an *argument strength* model which integrates both functions. Argument strength distinguishes between strong arguments and their weak counterparts, and it is measured by *discourse prominence*. In their view, differential marking involves strong arguments, i.e. subjects and objects.

Most literature that proposes these alternative functions as motivations for DOM do not elaborate on the role of pronominal marking, which is also a cross-linguistically attested strategy for DOM. In addition, these notions are formulated based on the relative markedness of the subject and the object, and say little about the relations between objects in multiple object constructions. Since some languages employ case marking while others alternatively employ pronominal indexation in DOM, these may be viewed as alternative strategies.² However, it is also widely observed that some languages employ both case marking and pronominal indexation in this phenomenon. Indeed, Tigrinya is one of them. These two strategies should not be regarded as having an overlapping function, in the sense that they are doubly marking a single feature, for as we have seen, Tigrinya data manifest an interesting interdependence between the two markers. Furthermore, the different patterns that arise from the absence and presence of case marking and pronominal indexation encode different grammatical properties.³

Dalrymple and Nikolaeva (2011:14) argue that the various criteria, such as semantic features (humanness, animacy, definiteness, specificity) or discourse prominence (as manifested by individuation), that are proposed as motivations for grammatical marking could not explain the cross-linguistic variations manifested in DOM since previous studies considered a limited set of features. They claim that the information structure approach they propose can account for most of the variations that previously examined features cannot adequately account for. In their

²Nichols (1986), for example, discusses dependent marking (case) and headmarking (verbal indexation) as alternative strategies.

³For a detailed discussion on the interdependence of case marking and pronominal indexation in Tigrinya, refer to chapter 8.3.1, and Nazareth (2007, 2008).

view, DOM indicates variation in information structure which concerns topic objects. They also maintain that DOM has a different functional motivation than what has been proposed by functional typological studies. According to Dalrymple and Nikolaeva (2011:15), “DOM was originally motivated by the need to highlight **similarities** between subjects and topical objects, which tend to be grammatically marked, as opposed to nontopical objects.” Hence, they assert that DOM codes a property which is common to subjects and to some objects, but less common to noncore grammatical functions.

Similarly, based on his observation of *Tukang Besi*, an Austronesian language of central Indonesia, Donohue (2001:236) argues that the function of the applicative morpheme is to indicate that the argument it refers to has greater discourse salience or topic continuity than otherwise would be expected of it in a neutral discourse context. He observes a significant interaction between applicativization and relativization that supports the core status as well as the topic status of applied objects. He states that in order to topicalize an oblique argument by means of a relative clause, that argument must assume core object status by means of the applicative process (Donohue 1996:160). As was discussed in chapters 6 and 8.3, a similar tendency is observed in the *Tigrinya* applicative construction. An argument that is normally associated with a non-core grammatical function, is coded as an applied object through verbal indexation and objective case when it corresponds to a discourse salient referent. Moreover, only applicatively coded peripheral semantic roles have access to relativization, as the relativization test we employed in chapter 8.2.3 shows.

In the following section we will discuss the relatedness of information structure roles and DOM.

9.3.1 Information structure roles: topic and focus

Halliday (1967:199) uses the label *information structure* as a definitional element of *theme*. He defines *theme* as the discourse component of grammar concerned with the information structure of the clause. Lambrecht (1998:2) uses the term *information structure* in his influential book entitled *Information structure and semantic form: Topic, focus and the mental representations of discourse*. Lambrecht remarks that this term (as opposed to other rubrics such as “theme”, “information packaging” (Chafe 1976) and “discourse pragmatics” (Vallduví 1992)) emphasizes the *structural/formal* characteristics of the discourse/pragmatic analysis. He defines information structure as:

That component of sentence grammar in which propositions as conceptual representations of states of affairs are paired with lexicogrammatical structures in accordance with the mental states of interlocutors who use and interpret these structures as units of information in given discourse contexts. (Lambrecht 1998:5)

Information structure is a formal/structural representation of the pattern of propositions in a clause. According to Lambrecht (1998:6), speakers organize the message of their utterance into components, namely: (i) *presupposition and assertion*, the portions of propositions which represent what is already familiar and known to the addressee, and what is not familiar and known; (ii) *identifiability and activation*, the assumptions that the speaker maintains at the time of utterance about the mental representation of discourse referent in the addressee's mind; and (iii) *topic and focus*, the speaker's evaluation of what is predictable or unpredictable concerning the relations between propositions and their elements in a given discourse. These different units of information structure are related to each other. Presupposition and assertion correspond to old information and new information, respectively, which in turn is related to topic and focus.

Lambrecht (1998:118) defines topic as the entity that the proposition expressed in an utterance is *about*. According to him, this definition is related to the definition of the subject in traditional grammar in the sense that the *aboutness* that relates an entity to a proposition has been regarded as a property of the subject. Nonetheless, he maintains that the two concepts, topic and subject, do not always converge. Grammatical subjects may not always correspond to topics, and vice versa. He argues that syntactic arguments other than the subject can assume the role of a topic, and a clause can also code several topics (Lambrecht 1998:146). Lambrecht (1998:206) defines focus as the element coinciding with new information which is *added* to the pragmatic presupposition. He argues against the notion of focus given by Chafe (1976), who considers focus as a *complement of topic* or new information about the topic. According to Lambrecht, sentences always convey new information, i.e. they must always have a focus, but the new information cannot always be about a topic, since sentences do not necessarily code a topic. Therefore, focus must be regarded independently of topic.

Dalrymple and Nikolaeva (2011:45) describe information structure as the main function of language, which aims to facilitate exchange of information or communication. Speakers structure their utterances in a discourse situation according to what they perceive as the addressee's current state of knowledge. The speaker's evalua-

tion of information according to what is already known to the addressee (old knowledge), and what is novelty (new knowledge) is linguistically indicated. Dalrymple and Nikolaeva (2011:45) state that “[...] propositions can receive different formal expression (are packaged) in accordance with what the speaker assumes to be old or new information for the addressee”. According to Lambrecht (1998:6), clause constituents that convey information structure roles tend to be formally marked for this function; for example, by the position they hold in a clause, morphological inflections (case, verbal indexation) or prosody. Similarly, Dalrymple and Nikolaeva (2011:45) maintain that DOM is a formal coding of the information structure role that corresponds to a topic object. According to them, even though differentially coded objects tend to correspond to prominent or salient referents (such semantic features as animate, definite or specific), such properties alone do not grant them topic status.

Nikolaeva (2001:26) designates the information structure role pertaining to the object as a *secondary topic* in order to distinguish it from the information structure role designated as a *primary topic* that may be assumed by the subject in a clause that realizes both. Nikolaeva defines secondary topic as “an entity such that the utterance is construed to be ABOUT the relationship between it and the primary topic”. As this definition implies, the realization of the secondary topic depends on the existence of a *primary topic*. Dalrymple and Nikolaeva do not assume, however, that primary topic and secondary topic are ordered with respect to each other in terms of salience. The classification as *primary topic* and *secondary topic* may be well motivated in discourse situations where there are two topical elements: one associated with a subject and another with the object; however, these categories cannot neatly describe the discourse situation where there is only one topic which corresponds to the object. For example, Tigrinya applicative clauses with intransitive verbs code the applied object as the only salient entity in the discourse. In such as clause the object corresponds to the primary topic role. It is beyond the scope of this thesis to provide a thorough discussion of information structure roles. Our aim is rather to provide a preliminary discussion of objects and the information structure roles with which they may be associated.

A vast body of research predicts a correlation between grammatical agreement and discourse functions (Givón 1976, Rude 1986, Bresnan and Mchombo 1987, Comrie 2003, Morimoto 2009). Givón’s (1976) typological study has proven to be particularly influential. Givón systematically explained various diachronic data and demonstrated that agreement markers evolved from topic pronouns to clitic

pronouns and finally to redundant agreement markers. Following Givón, Bresnan and Mchombo (1987) propose a “theory of agreement” in order to account for the function of subject and object verbal markers in Chicheŵa within the framework of LFG. Their approach has influenced a wide body of research in LFG. Bresnan and Mchombo’s study of Chicheŵa subject and object verbal markers does not directly address DOM, but since their aim is to account for the distribution of grammatical agreement and pronominal incorporation, their work has some relevance to the discussion of DOM, on the one hand, and information structure roles, on the other. Bresnan and Mchombo convincingly demonstrate that subject pronominal affixes are ambiguous markers of grammatical and anaphoric agreement, whereas object pronominal suffixes are only topic/anaphoric markers. In Chicheŵa, subject verbal affixes are obligatory and the subject nominal may not always be present in the clause. On the other hand, object verbal affixes only occur under certain conditions. When the verb does not bear an agreement marker for the object, the object nominal must be present in the clause. The object nominal becomes optional in the presence of object pronominal affixes. Therefore, the discourse function that they assume for the pronominally marked object resembles the information structure role assumed by the differentially marked object.

9.3.2 Verbal indexation: agreement vs. anaphoric marking

Givón (1976:149) argues that agreement and anaphoric marking are essentially the same process and that they cannot be distinguished either diachronically or synchronically. His proposal regarding the differences between the pronominal and nominal structure found in the *imperfective* and *perfective* verb conjugation systems in Semitic languages has been influential in Semitic studies. Tigrinya, like other Semitic languages, has two types of verb conjugation system: the *imperfective* and the *perfective* (see chapter 2.4.1). The imperfective verb conjugation is known as a prefix system even though it displays partial agreement specification as a prefix and partial specification as a suffix. However, in the perfective verb form the subject pronominal marker is a suffix. This is illustrated in Table 9.1.

As these examples show, the person, gender and number markers in the perfective historic and perfective simple forms are all suffixes. On the other hand, in the imperfective forms the person marker is a prefix and the gender-number markers are suffixes. The suffix morphemes in the perfective simple forms, and partially in the perfective historic and imperfective forms are similar to the agreement morphemes found in independent person pronouns. For example, *-u* in **ʔŋ** *nis-u* ‘he’,

	Perfective		Imperfective
<i>Values</i>	<i>Perf. Historic</i>	<i>Perf. Simple</i>	
3MSg	ሰበረ	ሰበሩ	ይሰብር
	säbär-ä	säbir-u	yi-säbbär
	PerfH.break-SM.3MSg	PerfS.break-SM.3MSg	Imperf.3-break.SM.MSg
3MPI	ሰበሩ	ሰበሮዎ	ይሰብሩ
	säbär-u	säbir-om	yi-säbbir-u
	PerfH.break-SM.3MPI	PerfS.break-SM.3MPI	Imperf.3-break-SM.MPI

Table 9.1: Prefix and suffix subject markers

and *-om* in ንሳተዎ *-nisat-om* ‘them (M)’ code the same values in perfective simple verbs indicating their etymological relationship to independent pronouns. However, *-u* marks third person plural subjects in perfective historic and imperfective verb forms as well. This indicates that agreement morphemes in these verb forms are incompatible with the agreement morphemes in independent personal pronouns (See chapter 2.3.2 for a complete list of agreement morphemes in pronouns).

Furthermore, there is a close resemblance between object verbal suffixes and agreement morphemes in independent pronouns (see Table 4.1 and Table 4.2 in section 4.3 for a complete list of the object suffixes OM₁ and OM₂, respectively). Object pronominal marks are suffixes, including in the imperfective verb forms. The comparability can be observed from the forms given in Table 9.2.⁴

Perfective		Imperfective
<i>Perf. Historic</i>	<i>Perf. Simple</i>	
ሰበሮ	ሰበሩዎ	ይሰብሮ
säbärä-o	säbir-u-wo	yi-säbbär-o
PerfH.break.SM.3MSg -OM ₁ .3MSg	PerfS.break-SM.3MSg-OM ₁ .3MSg	Imperf.3-break.SM.MSg-OM ₃ MSg
ሰበሩዎዎ	ሰበሮዎዎዎ	ይሰብሩዎዎ
säbär-u-wom	säbir-om-wom	yi-säbbär-u-wom
PerfH.break-SM.3MPI-OM ₁ .3MPI	PerfS.break-SM.3MPI-OM ₁ .3MPI	Imperf.3-break-SM.MPI-OM ₁ .3MPI

Table 9.2: Suffix object markers

Similarly, the second set of pronominal suffixes (OM₂) bears the same agreement morpheme as the OM₁ forms (See Table 4.2 in chapter 4.3). In addition to agreement morphemes, OM₂ is marked with the prepositional particle *-l-* which together with the agreement morphemes, constitute the OM₂ form. This particle is etymologically related to dative personal pronouns which are evident in Semitic languages such as Tigre and Ge’ez. For example, the marker *-la* in *säbirä-u-la* ‘he broke (something) for/on her’, which codes a beneficiary or an adversely affected

⁴In some of the forms epenthetic segments such as *-w-* appear between the subject and the object pronominal suffixes; these are motivated by syllabic constraints on word formation in Tigrinya.

object, can be identified in the Tigre feminine singular third person pronoun *ʔig-l-a* ‘to her (dative)’ which, in turn, is formed out of the dative preposition *ʔig-l-* ‘to/for/in order to’ and the pronominal suffix *-a* ‘3FSg’.

The morphological similarity between independent pronouns and object pronominal affixes in Tigrinya seems to support Givón’s claim that pronominal affixes evolved from topic pronouns/anaphoric pronouns to agreement markers. It is beyond the scope of this thesis to outline the historical development of agreement markers in Tigrinya. Suffice it to say that the conjugation systems in the two perfective verb forms, as well as that of the imperfective verb form, reflect different grammaticalization processes in Tigrinya.

Bresnan and Mchombo (1987) argue that the fact that anaphorically linked arguments and pronominal affixes in a discourse are required to show gender, number and person agreement indicates the anaphoric function of pronominal affixes. In languages like Tigrinya, object pronominal markers are triggered by semantic features such as definiteness or specificity which are also properties of salient or individuated object referents. In accordance with Bresnan and Mchombo’s proposal, the object verbal marker should be assumed to be a topic marker rather than a grammatical agreement marker. On the other hand, the subject marker is obligatory, and it can correspond to a non-referential and non-topical subject. For example, Lambrecht (1998:137) argues that in a context where the whole predicate is focused, the subject is not a topic since the whole proposition is covered by the focus discourse function. The subject marker functions as an anaphoric marker when it corresponds to topical subject NPs in a discourse. We will illustrate this by way of examples from a real discourse context as in (304).

- (304) a. **ኣብ ማዕድ፡ ሓደ ምትፃት ዚመስል ጻዕዳ**
ʔabi maʕido ɣadä mitihati z-i-mäsili ʂaʕida
 Loc distance one.MSg ghost Rel-Imperf.SM.3-resemble.SM.MSg white.Sg
ነገር ረኣኹ።
nägäri räʔa-ku
 thing.Sg PerfH.see.SM.1Sg
 ‘At a distance, I saw a white thing which resembled a ghost.’
- b. **ናባይ ምስ ቀረበ ገን፡ ጀለብያ**
nab-ayi misi qärabä gini ğäläbiya
 to-Pro.1Sg when PerfH.near-SM.3MSg but djellaba
ዝለበሰ ቀልፃ ምኻኑ ተገንዘብኩ።
zi-läbäs-ä qoliʕa mi-kan-u tä-gänizäbi-ku
 Rel-PerfH.wear-SM.3MSg child.Sg VN-be-Poss.3MSg PerfH.realize-SM.1Sg
 ‘But when it neared me, I realized that it was a child who wore a djellaba (robe).’

(Source: Hadas Ertra 2007, Issue 17, no.13)

In this discourse, the antecedent of the referent coded via the subject verbal suffix (SM.1Sg) that the verbs *rä?a-ku* ‘I saw’ and *tä-gänizäbi-ku* ‘I realized’ bear is not overtly realized. The referent can only be recovered from the discourse context. Since the text is a narrative discourse and is told in the first person, the speaker is backgrounded in the discourse, and is therefore coded through the incorporated pronoun. Thus, the pronominal suffix has an anaphoric function here.

The evidence that Bresnan and Mchombo (1987:652) take to support their argument for the anaphoric function of pronominal affixes is ‘locality’. They state that in order “to satisfy the completeness and coherence conditions [such] argument functions (SUBJ, OBJ, etc.) must be expressed syntactically within the phrase structures headed by the predicator, or expressed morphologically on the head itself, or else remain unexpressed”. Morphologically expressed argument functions are anaphorically or functionally controlled by structures outside the clause that contains the predicator that bears affixes for them. They stress that only anaphoric agreement relations can be non-local to the agreeing predicator. Under these conditions, then, the subject pronominal suffix (SM.1Sg) in the first sentence (304a) functions as an anaphor or a topic marker since it agrees with an argument which is not locally present in the same clause.

In the same sentence (304a), the object argument is new information in this discourse context. The numeral *ḥadä* ‘one.M’ introduces an indefinite object, and the verb does not bear a suffix for it. The object is required to be in the same clause as the predicator and assumes a focus discourse function. The second sentence (304b) consists of a dependent and an independent clause which are demarcated by the sentence adverbial ‘but/however’. The dependent and independent clauses denote old and new information, respectively. The verb ‘*near-SM.3MSg*’ in the dependent clause contains a subject incorporated pronoun which corresponds to the object antecedent *ḥadä miṭiḥati z-i-mäsili šaṣida nägäri-* ‘a white thing which resembles a ghost’, which is mentioned in the previous discourse (304a). The independent clause on the other hand, adds new information about the object *ḡäläbiya zi-läbäs-ä qoliša mi-kan-u* ‘that it was a child who wore a djellaba’, and thus the main verb ‘*PerfH.realize-SM.1Sg*’ does not bear an object suffix, it only contains a subject suffix which refers to the narrator. The object of the main clause is coded as a subject via the subject suffix on the relative verb. Therefore, as is illustrated in these examples, the subject and the object pronominal affixes have an anaphoric function, and link to topic NPs or even to another incorporated pronoun in a discourse.

The subject pronominal affixes can also function as grammatical agreement markers. In Tigrinya, applicative constructions which involve psych verbs code non-referential subjects through the subject verbal affix. When there is an overt subject phrase in the clause, the construction shows a subject-object reversal word order pattern, i.e. O(S)V, where the salient object is obligatorily preposed before a non-referential/athematic subject, as in (305).

- (305) a. ሕጂ፡ (ኣ/ገግጾ) ደኽ-ሙ-ኒ ኣሎ ።
 ḥiǰi (ʔanä/ni-ʕayä) däkim-u-ni ʔall-o
 now (Pro.1Sg/Obj-Pro.1Sg) PerfS.tire-SM.3MSg-OM₁.1Sg Pres.exist-SM.3MSg
 ‘Now, I am tired./ Lit. Now, it has tired me.’
- b. ሕጂ፡ (ኣ/ገግጾ) ደኽ-ሙ ኣሎኹ ።
 ḥiǰi (ʔanä/*ni-ʕayä) däkim-ä ʔallä-ku
 now (Pro.1Sg/*Obj-Pro.1Sg) PerfS.tire-SM.1Sg Pres.exist-SM.1Sg
 ‘Now, I am tired.’

Example (305a) shows that the main verb *däkim-u-ni* ‘tired-it-me’ and the locative auxiliary verb *ʔall-o* ‘Loc.be/exist.it’ code a non-referential or athematic subject through the ‘3MSg’. The object suffix corresponds to an experiencer object argument. In such constructions, either the nominative or objective case can be employed to mark the object nominal. In Tigrinya, topical objects are often marked with the nominative case, which makes them comparable to subjects. In contrast, in the non-applicative clause (305b) the objective pronoun is ungrammatical since the experiencer argument is expressed as a subject via the verbal suffix.

In the following section we will discuss the correspondence between differentially coded object functions and information structure roles in applicative and double object clauses in Tigrinya.

9.4 DOM and information structure roles

As was mentioned earlier, DOM in Tigrinya involves case marking and pronominal affixation. In section 9.3 we discussed two different interpretations – discriminatory and coding – of the function of DOM. In the discriminatory function view, marking arises from the need to distinguish between arguments that possess similar properties. Since salience is assumed to be a typical property of a subject, a salient object is identified by some sort of marking in order to distinguish it from the subject. In contrast, according to the coding/indexing function view, marking is assumed to index certain properties of objects that their unmarked counterparts lack. These functional interpretations are often given for case marking, but rarely

for pronominal indexation. In addition, these interpretations have little to say about languages which employ both strategies. In section 9.3.2 we discussed studies that associate pronominal indexation with discourse topicality, such as those of Givón (1978) and Bresnan and Mchombo (1987:652).

Based on our observation of Tigrinya, we argued that case marking and pronominal indexation have separate functions. Double marking signals double function, and thus when these strategies are involved in the same language, they must not be thought of as alternative strategies. As was discussed in chapter 8.2, coding strategies such as word order, pronominal indexation and case marking work together to identify grammatical function. Additionally, they signal the presence or the absence of certain grammatical properties. For example, a difference in word order signals a difference in the pragmatic reading of object referents, and the presence of pronominal indexation indicates salience of objects. In section 8.3, we discussed the different grammatical function analyses that an object argument may yield if we posit pronominal indexation or case marking as properties of primary objecthood in isolation. This supports our proposal that these strategies identify different grammatical properties of objects. In the following section, we will motivate the alignment of object functions with the topic information structure role. In this work we will only represent the alignment of the marked object to topic roles. We will not consider the alignment of the subject or of the unmarked object. We assume that marked objects can associate with TOPIC₁ or TOPIC₂. Marked objects that co-occur with a prominent/salient subject will align to TOPIC₂, and marked objects that appear in a clause where there is no thematic subject will align to TOPIC₁.

9.4.1 Alignment in monotransitive clauses

In chapter 8.3.3 we demonstrated that, in Tigrinya, DOM does not correlate with a difference in the grammatical function of objects. Thus, the unmarked object and the marked object assume the same grammatical function. Instead we argued that marking differences correlate with topicality or definiteness of objects. We repeat example (302) in (306) in order to restate this point.

- (306) a. ገንዘብ ወዲኡ ቶ
 gänzäb wädi?-ä
 money Perf-finish-SM.1Sg
 ‘I ran out of money./Lit. I finished money.’
- b. ነት (ገንዘብኒ) ገንዘብ
 nät-i (zi-hab-ka-nni) gänzäb
 Obj-Det-3MSg (Rel.PerfH.give-SM.1Sg-OM₁.3MSg) money

ወዲኡኡ ።

wädi?-ä-yo

Perf-finish-SM.1Sg-OM₁.3MSg

‘I finished/used up the money (which you gave me).’

As was discussed in chapter 8.3.3 and 9.3, both in the clause with the unmarked object (306a) and in the clause with the marked object (306b), the object *gänzä* ‘money’ is affected, in the sense that in both cases it is consumed. However, these two structures are contrasted, as the indefinite/unmarked object codes a general sense that the speaker ran out of money. Hence, the money that has been used up is not identifiable by the addressee. In contrast, in the marked structure the addressee identifies the money that has been used up. Thus marking does not indicate a difference in the basic semantic affectedness of the object argument, but rather their discourse individuation. Therefore, in monotransitive clauses the unmarked and marked objects assume the same grammatical function (OBJ), but are correlated with different information structure roles: the unmarked is non-topic/non-individuated and the marked is topic/individuated. Definite objects of monotransitive verbs are marked with the suffix OM₁, which indicates semantic affectedness of the argument. The linking pattern between semantic roles and object functions is given in chapter 8.3.3. Below, we add the information structure role of the marked object to the representation (307).

(307) *Alignment in monotransitive clauses*

<i>unmarked</i>	<i>marked</i>
patient	patient
OBJ	OBJ
	TOPIC ₂

In Tigrinya we assume that the topicality of objects is indicated by pronominal marking. There are two facts that support this reasoning, namely the optionality of case marking and the obligatoriness of pronominal marking in the coding of definite objects. Case marking is optional when the object referent is the most salient entity in a clause. This tendency was discussed in relation to applicative clauses formed out of intransitive verbs where the referents of applied objects are more prominent or reflect a higher animacy property than the subject referent. For example, a pos-

essor object is rated higher on the animacy/prominence scale than a possessee subject in possessive applied constructions, and an experiencer object that co-occurs with an athematic subject is semantically prominent (see chapters 4.4.7 and 4.4.6). On the other hand, pronominal markers are obligatory as in all other applicative constructions. We repeat example (140b) in (308) in order to restate these points.

- (308) (ḡ)ḡḡḡḡḡ ḡḡḡḡḡḡ ḡ
 (ni-)ʔaster ḡḡḡḡḡḡ ḡ
 (Obj-)Aster.F PerfS.(become-tense)-SM.3MSg-OM₁.3FSg
 ‘Aster is stressed/worried./ Lit. It has become tense to Aster.’

In this expression, the experiencer is the only semantic argument of the applied predicate. The subject is athematic, and is indexed through the third person masculine singular subject verbal suffix. This clause has OV order, and such clause initial objects get optional case marking. The subject pronominal suffixes occur regardless of whether the subject itself occurs overtly, or not. In clauses where the object is the only prominent/salient argument, the marked object assumes the TOPIC₁ role, as shown in (309):

- (309) *Alignment in applicative of intransitive bases*
marked

experiencer
 |
 OBJexper
 |
 TOPIC₁

The predicates in these constructions are not base transitive verbs. They are applied verbs formed out of unaccusative/intransitive bases. Therefore, the object arguments that these predicates are subcategorized for are associated with restricted objects which bear labels for the semantic role they are restricted to; for example, the experiencer objects will be identified as OBJexper, and the possessor as OBJposs.

9.4.2 Alignment in ditransitive clauses

We assume that the same criteria that motivate DOM in monotransitive clauses also motivate marking of objects in ditransitive clauses. Pronominal indexation is obligatory, and only salient/definite objects control pronominal marking. The goal

object controls pronominal marking only when it is definite. On the other hand, objects in ditransitive clauses are governed by different case marking constraints than objects in monotransitive clauses. Goal/recipient objects are obligatorily case marked independently of the definiteness status of their referents. In some situations, case marking can also be optional for definite/salient goal objects (similar to theme objects in monotransitive clauses). The ditransitive clauses in (310) illustrate the coding of an indefinite and a definite goal object. The theme object is indefinite in both sentences.

- (310) a. መንግስቲ ንዝኸታማት ሓገዝ ሂቡ።
 mängisti ni-zäktam-at ḥagäz hib-u
 government.Sg obj-orphan-Pl aid/help PerfS.give-SM.3MSg
 ‘The government gave aid/help to orphans.’
- b. እቲ ሓረስታይ ነተን ከብቲ ሳዕሪ ሂቡወን።
 ?it-i ḥarästay n-ät-än käbti saʿri hib-u-wän
 Det-3MSg farmer.Sg Obj-Det-3FPI cattle grass PerfS.give-SM.3MSg-OM₁.3FPI
 ‘The farmer gave the cattle grass.’

In (310a) the goal object bears the prepositional case marker *ni-*, but since both objects are indefinite, neither of them can control pronominal marking. In (310b) the definite goal object is indexed on the verb and bears the same case marker as the indefinite goal object. Due to the fact that goal objects (both definite and indefinite) must be case marked in Tigrinya, we assume that the OBJ_{goal} is semantically restricted to the goal/recipient reading, and thus the theme bears the OBJ function.

In clauses where both objects are definite, the object suffix is associated with the object that is most salient in the discourse. In such clauses the order of the two objects becomes fixed, as is shown in (311).

- (311) a. እቲ ሓረስታይ ነቲ ሳዕሪ ነተን ከብቲ
 ?it-i ḥarästay n-ät-i saʿri n-ät-än käbti
 Det-3MSg farmer.Sg Obj-Det-3MSg grass Obj-Det-3FPI cattle
 ሂቡወን።
 hib-u-wän
 PerfS.give-SM.3MSg-OM₁.3FPI
 ‘The farmer gave the cattle the grass.’
- b. እቲ ሓረስታይ ነቲ ሳዕሪ ነተን ከብቲ
 ?it-i ḥarästay n-ät-i saʿri n-ät-än käbti
 Det-3MSg farmer.Sg Obj-Det-3MSg grass Obj-Det-3FPI cattle
 ሂቡዎ።
 hib-u-wo
 PerfS.give-SM.3MSg-OM₁.3MSg
 ‘The farmer gave the grass to the cattle.’

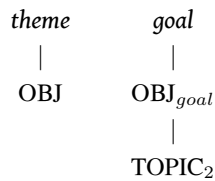
(314) *Alignment ditransitive clauses*a. *unmarked OBJ vs. marked OBJ_{goal}*b. *marked OBJ and marked OBJ_{goal}*

OR

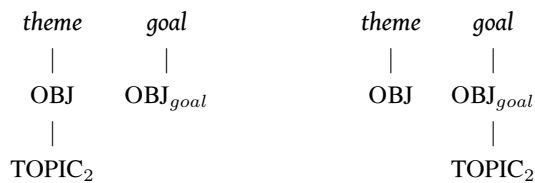
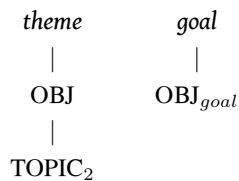
c. *human/marked OBJ versus marked OBJ_{goal}*

In the following section we will present the pattern of coding and alignment of applied objects to topics in applicative clauses formed out of transitive base verbs.

9.4.3 Alignment in applicatives of transitive bases

The alignment pattern of objects and information structure roles in clauses that involve applied predicates formed out of transitive bases differs significantly from the alignment patterns found in monotransitive and ditransitive clauses illustrated above (see chapter 9.4.1 and 9.4.2). Applied objects in these clauses may be associated with beneficiary, locative, source or instrumental semantic roles. Further, the applied object can control pronominal marking. Applied objects are marked with the objective case *ni-*, like recipients/goals and definite theme objects. In chapter

8.3.2 we proposed that the applied argument is associated with the restricted object OBJ_{θ} because they do not possess the kind of patient-like property that the recipient object and theme object have. In this study, we group applied objects that express these semantic roles under the rubric OBJ_{appl} . Our use of OBJ_{appl} is motivated by the ambiguity that the pronominal suffix OM_2 reflects. This suffix is underspecified for the semantic roles with which the applied object is associated. In clauses where the semantics of the base verb allow several of these readings, the applied object becomes ambiguous (315).

- (315) አቲ ሰብአይ ነታ ሰበይቲ ደርሆ
 ?it-i säbʔay n-ät-a säbäyti dārho
 Det-3MSg man Obj-Det-3FSg woman chicken.Sg
 ሸይጡላ ።
 šäyt-u-la
 perfS.sell-SM.3MSg- OM_2 .3FSg
 ‘The man sold a chicken to/for/on the woman.’

In this example, the applied object can have a goal, a beneficiary or a maleficiary semantic role reading. Therefore, the OBJ_{appl} category allows the applied object to be underspecified for the semantic roles it expresses. The theme object is analyzed as OBJ in these applicative clauses. The linking pattern in this type of applicatives is schematically shown below (316):

- (316) *Alignment in applicative clauses with transitive bases*

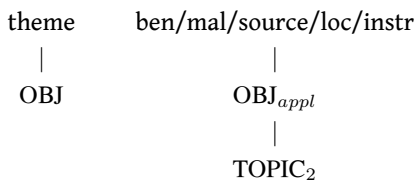

Definite theme objects cannot be indexed on the verb when they co-occur with an applied object, unlike in ditransitive clauses. Thus, the theme object cannot assume a topic role in these constructions. When the theme object is marked on the verb, the construction ceases to be an applicative expression. This supports our assumption that the applicative expression is discourse motivated. The applicative expression gives semantic participants access to topicalization. Semantic participants that are involved in this phenomenon normally are not associated with core grammatical functions, and thus through applicativization these are coded as argument functions. The Tigrinya data indicate that applied objects are marked for their

affected goal argument since the referent of the theme argument does not physically move towards it. For this reason, the passive reading is blocked (320b).

We analyze applied objects that display genuine affectedness properties as OBJ_{goal}, and those that display ethical or abstract affectedness as OBJ_{appl}. In addition, applied objects formed from intransitive base verbs correspond to the TOPIC₁ role. These normally occur in clause initial position and involve an optional case marker *ni-*. The applicative clause is characterized by the subject-object reversed word order: OSV. In this clause, the applied object is the most topical element in the discourse. The mapping pattern in the applicative clause is schematically represented in (321) below:

(321) a. *Directly affected*



b. *Ethically affected*

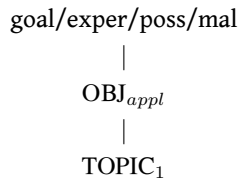

Applied predicates formed out of intransitive bases can also allow the suffix OM₂ to express a beneficiary or locative semantic role (322). The applied object's reading depends on whether the referents have a semantic disposition to be interpreted as either a beneficiary or a locative.

(322) a. **ኧቲ ቆልኻ ነሳባ ደቂሱላ።**
 ?it-i qolʕa ni-Saba däqis-u-la
 Det-3MSg baby.Sg Obj-Saba.F perfS.sleep-SM.3MSg-OM₂.3FSg
 'The baby has slept for Saba. (She is a beneficiary of him being asleep.)'

b. **ኧቲ ቆልኻ ነታ ኅራት**
 ?it-i qolʕa n-ät-a ʕarat
 Det-3MSg baby.Sg Obj-Det-3FSg bed.Sg

ደቂቅ-ላ ።
 däqis-u-la
 perfS.sleep-SM.3MSg-OM₂.3FSg
 ‘The baby slept (on) the bed.’

Since in (322a) the applied object corresponds to a human referent, it is interpreted as a beneficiary, whereas in (322b) it is associated with a referent that has a spatial sense/semantics, and thus it gets interpreted as a locative argument. The objective case (*ni-*) is obligatory when the applied object occurs in the canonical object position.

These semantic roles cannot be associated with the subject in a passive applied predicate. The passive applicative predicate involves a subject verbal suffix which codes an athematic expletive subject (323).

(323) ነታ/እታ ዓራት ተደቂቅ-ላ ።
 n-ät-a/ʔit-a ʔarat tä-däqis-u-la
 Obj-Det-3FSg/Det-3FSg bed DT-perfS.sleep-SM.3MSg-OM₂.3FSg
 ‘The bed has been slept on.’

The passive predicate has only one thematic argument which is expressed as an applied object. This clause is characterized by the OV structure and the optionality of case marking since either case marked determiner *n-ät-a* or *ʔit-a* can be used in this structure. We analyze applied arguments of this type as OBJ_{appl}, and they assume the TOPIC₁ role. In (324) we illustrate the alignment pattern in applied intransitive predicates that mark applied objects with the suffix OM₂.

(324) a. Active: OBJ_{appl} marked with OM₂

ben/loc
 |
 OBJ_{appl}
 |
 TOPIC₂

b. Passive: OBJ_{appl} marked with OM₂

ben/loc
 |
 OBJ_{appl}
 |
 TOPIC₁

Applied objects of intransitive applied predicates can be associated with either of the object suffixes OM_1 or OM_2 . Applied objects coded through the suffix OM_1 fall into two groups. When OM_1 is attached to intransitive verbs of movement that code an agent-like initial argument, the applied object displays genuine patient-like properties. Applied objects of these kinds of verbs are associated with OBJ_{goal} . When OM_1 attaches to intransitive verbs with unaccusative semantics, where the initial argument does not reflect agent-like properties, the applied object is understood to be an ethically or psychologically affected object. These arguments do not show genuine affectedness properties, and thus cannot be analyzed as OBJ or OBJ_{goal} . These are instances of the restricted objects that are grouped together under OBJ_{appl} . In our implementation of the grammar, we refer to them also by the specific semantic role reading they express; for example, OBJ_{exper} , OBJ_{poss} , OBJ_{mal} , etc. Unaccusative verbs also allow the suffix OM_2 to code beneficiary and locative readings. The beneficiary and the locative applied objects are also classified as OBJ_{appl} . They do not correspond to genuinely affected arguments.

9.5 Conclusion

This chapter discussed how marked objects align to information structure roles. We have argued that the same criteria that motivate DOM in monotransitive clauses also motivate object marking in ditransitive and applicative clauses. Tigrinya employs case marking and pronominal indexation to mark definite and specific objects that correspond to salient/individuated discourse referents. Our claim is supported by patterns of objects that occur in clauses with ditransitives, as well as applicatives formed from transitive and intransitive base verbs. When two objects that have referents with similar semantic dispositions, occur in a ditransitive clause, the clause becomes ambiguous, as the objects compete to control pronominal marking. This ambiguity can only be resolved by referring to the discourse context. The object that is perceived to be salient in the discourse context wins over for pronominal marking. Moreover, in applicative clauses formed from intransitive bases, as well as in passive constructions that involve applied verbs formed out of transitive bases, applied objects occur in clause initial position. In this position, applied objects are optionally case marked. We regard such behavior to be typical of primary topics ($TOPIC_1$). When the applied object is the most salient argument in the clause, it tends to be unmarked for the objective case, like the subject.

In this chapter, we only considered the alignment of marked objects to infor-

mation structure roles. However, we acknowledge that marked objects and the information structure roles that are assumed to be associated with them must be examined in relation to other objects as well as to the subject when they co-occur in the same structure. We plan to investigate these issues in future research.

Part IV

Implementation and conclusion

CHAPTER 10

XLE implementation of Tigrinya

10.1 Introduction

In this chapter we will present the computational implementation of Tigrinya grammar. The grammar is implemented on the Xerox Linguistics Environment (XLE), a computational grammar development platform for LFG. XLE was designed at PARC – the Palo Alto Research Center. The system has been regularly updated to address issues that emerge as many typologically diverse languages start to use the platform (Kaplan and Maxwell 1996, Butt and King 2007). XLE allows the grammar developer to define a grammar based on LFG notations. The international research network the Parallel Grammar project (ParGram), and the Parallel Semantics project (ParSem), which is concerned with the implementation of semantics, meet twice a year to discuss LFG grammar implementation issues on the XLE platform. This initiative aims to standardize grammatical features used in the development of wide coverage parallel (comparable) grammars for diverse languages including Arabic, Chinese, English, German, Georgian, Hungarian, Indonesian, Japanese, Norwegian, Tigrinya, Turkish and Urdu, among others. The common features that are agreed upon by ParGram members can be found on the project's website.¹

The Tigrinya grammar is at its earliest stage of development; however, it proves to be a useful testing ground for the linguistic phenomena dealt with in this study. In

¹ParGram's standard common features can be found in this link:
<http://www2.parc.com/isl/groups/nlft/xle/doc/PargramStarterGrammar/common.features.lfg>

order to implement Tigrinya applicative constructions, it was necessary to have in place a basic grammar for the language. The grammar accounts for various word order patterns and agreement conventions which involve verbs and their dependents, determiners and adjectives with nouns, and so on. The grammar can also handle complex nominal phrases that involve various types of specifiers and modifiers. Special emphasis was given to the representation of verbs that involve different types of subcategorizational patterns, for example, unaccusative and ergative intransitive verbs, transitive, ditransitive, raising and copulative predications. Various valency alternating operations such as passivization, reflexivization, causativization and applicativization are also accounted for in the grammar. In this chapter we will not be able to produce a detailed documentation of all phenomena dealt with in the implementation. In order to place double object and applicative constructions in the broad context of Tigrinya grammar, we will present the implementation of the basic clause.

This chapter is organized as follows. First, we will give a brief overview of the XLE parser and grammar development in this platform. Following that we will present the structure of the nominal phrase. Next, we will present the grammar of the basic clause. After that, we will illustrate the implementation of the passive. Finally, we will outline the implementation of double object and applicative constructions.

10.2 Implementing an LFG grammar in XLE

XLE is implemented in C, and it consists of a parser, a generator, a transfer module, and a rich grammar development environment. Since we will use the Tigrinya grammar only for parsing, we will focus on the parser and the grammar writing environment. Grammars can be written in Emacs, or any other editor. The grammar is loaded into the system which compiles it and employs its specifications to process a sentence or a string. The sentence to be analyzed is sent to the system via a tcl/tk user interface which provides powerful viewing and debugging utilities. The system produces windows which contain c-structure, f-structure, f-chat and packed solutions.

A sentence can also be analyzed via the XLE-Web interface, a web-based tool which uses the XLE parser and XLE grammars to display c-structure and f-structure along with a list of various discriminants which allow the user to dynamically choose the intended analysis of a sentence. XLE-Web is implemented by

Paul Meurer as part of the LOGON and TREPIL projects.² XLE-Web is publicly available and it is used by some of the ParGram grammars: Norwegian, English, German, Arabic and Tigrinya.³

In order to parse a sentence in the XLE system, grammar rules and lexical entries are the minimal requirements. Other possible components, such as templates, a morphological analyzer and a feature declaration can also be utilized. The XLE system enables the integration of external modules such as a tokenizer, Finite State (FST) morphology, and a guesser. In addition, XLE is also capable of dealing with large lexical databases. Currently, the Tigrinya grammar contains only grammar rules, lexical entries and templates. So far, morphological information is generalized through the use of template macros. We will illustrate the format of the basic components of an XLE grammar: the configuration, grammar rules, lexical entries and templates. As shown in the screenshot of an Emacs page in Figure 10.1, each grammar component begins with an instantiation line or a heading that shows a grammar version ID (e.g. MINI), a language ID (e.g. TIGRINYA), a component ID (e.g. CONFIG, RULES, LEXICON or TEMPLATES) and the XLE version number (1.0).

```

MINI TIGRINYA CONFIG (1.0)

RULES (MINI TIGRINYA).
ROOTCAT ROOT.
FILES TIGRIGRAM-lex.lfg TIGRIGRAM-lexfidel.lfg TIGRIGRAM-templates.lfg.
LEXENTRIES (MINI TIGRINYA).
TEMPLATES (MINI TIGRINYA).
MORPHOLOGY "(MINI TIGRINYA)".
GOVERNABLERELATIONS SUBJ OBJ OBJgoal OBJappl OBJposs OBJexper OBJjaff OBJmal COMP XCOMP PREDLINK
OBL OBL-ben OBL-loc OBL-instr OBJ-dat OBL-AG OBL-COMPAR X NULL.
SEMANTICFUNCTIONS TOPIC FOCUS ADJ XADJ.
FEATURES (all all).
NONDISTRIBUTIVES NUM PERS CONJ-FORM COORD POSTCOORD-FORM COORD-LEVEL GEND.
EPSILON e.
OPTIMALITYORDER NEUTRAL NOGOOD.
GENOPTIMALITYORDER NEUTRAL NOGOOD.
CHARACTERENCODING UTF-8.

----

MINI TIGRINYA RULES (1.0)
----

MINI TIGRINYA LEXICON (1.0)
----

MINI TIGRINYA TEMPLATES (1.0)
----

```

Figure 10.1: Basic components

The grammar version ID and the language ID may vary according to the version

²The LOGON and the TREPIL webpages can be checked in <http://www.emmtee.net/> and <http://gandalf.uib.no/trepil/>, respectively.

³XLE-Web can be checked here: <http://maximos.aksis.uib.no:8000/iness/xle.xml>

name and the type of the language used by the writer; however, the component IDs (RULES, LEXICON, TEMPLATES) cannot be arbitrarily modified since these are placeholders of components that interact with the parser module. Each component section must be terminated with four dashes (----). The grammar is entered under the respective headings (RULES, LEXICON and TEMPLATES), i.e. between the heading and the four dashes.

10.2.1 CONFIG

This is the configuration section of the grammar, which contains information that tells the XLE system about the files to be used with the grammar, and the type of components integrated in the grammar. It also gives information about some grammatical features and their functional classification.

ROOTCAT gives information about the the default category taken as the starting point in parsing. In the demo grammar we will use S as the default root category. We declare file names of components that are composed in separate files under FILES. Such files end with the *.lfg* extension because XLE expects all files to be saved in this format. The components of the Tigrinya grammar stored in three separate files. *TIGRIGRAM-lex.lfg* contains transliterated lexical entries, *TIGRIGRAM-lexfidel.lfg* contains lexical entries written in Ge'ez (fidel) script, and *TEMPLATES.lfg* is the template file.

In addition, the CONFIG component informs the system about which grammar rules, lexical entries and templates are to be used by specifying the relevant components under RULES, LEXENTRIES and TEMPLATES (MINI TIGRINYA). Under GOVERNABLERELATIONS the system is informed about the subcategorizable functions such as SUBJ, OBJ and OBL, and in way these are made to obey LFG's well-formedness conditions (biuniqueness, coherence and completeness). Governable relations are grammatical functions that appear inside the subcategorization frame of a predicator (e.g. a verb).

Governable relations that are linked to arguments in a frame have to contain a PRED feature as their value. The specification SEMANTICFUNCTION lists attributes whose value must contain the PRED feature. These include the non-argument function ADJ and the discourse functions TOPIC and FOCUS, among others. In the CONFIG section the XLE parser is also informed about category notations that are covert in the c-structure; for example, it is informed that the notation *e* is to be used for the empty category symbol.

The last line in the CONFIG section CHARACTERENCODING informs the

system about the type of the character coding used to enter the grammar. For Tigrinya we use UTF-8 (8-bit Unicode Transformation Format) encoding because this is a universal standard for languages that employ a non-ASCII character encoding.

10.2.2 RULES

The RULES section contains c-structure rules along with corresponding f-structure annotations. Since grammar rules in XLE are encoded only in pure ASCII characters, most of LFG's non-ASCII notational symbols have to be changed.⁴ In XLE each c-structure node in a rule is followed by its respective f-structure annotation, and the two parts are separated by a colon. A daughter with annotation is demarcated with a semicolon to enforce linear order, or a with a comma when the order of the daughters is free. Every rule is terminated with a full stop. The template in (325) illustrates the annotation of phrase structure rules in XLE.

(325)

```
Category --> Cat1: Schema1,
              Cat2: Schema2;
              Cat3: Schema3.
```

Cat1, Cat2 and Cat3 stand for phrase structure categories, and Schema1, Schema2 and Schema3 stand for their corresponding f-structure annotations, as is demonstrated by the S rule in (326), where NOM and V are categories, and the annotation schemata are put after the colon (:).

(326) Phrase structure rules

```
S --> NOM*: { (^ SUBJ)=!
              (! CASE)=nom
              | (^ OBJ)=!
              ~(! DEF)
              (! CASE)=nom
              ~(^ OBJ) <h (^ SUBJ) };
V:      ^=! .
```

NOM= {NP | DP | PROP | PRON}.

The ‘^’ and ‘!’ are equivalent to LFG’s \uparrow and \downarrow arrows, respectively. NOM is not a standard syntactic category per se. It is a metacategory defined as a set of

⁴LFG notations and their XLE-equivalents are given in the online XLE-documentation: <http://www2.parc.com/isl/groups/nltt/xle/doc/notations.html#N0A>

alternative values such as a noun phrase, a determiner phrase, a proper noun and a pronoun that function as nominal arguments in a clause.

10.2.3 LEXICON

The lexicon entries specify idiosyncratic lexical information, for example, subcategorization properties for verbs and count vs. mass information for nouns. The following template (327) illustrates the format of lexical entries in XLE.

(327)

```
lexical entry  Cat1  Morphcode1  Schema1;
               Cat2  Morphcode2  Schema2.
```

When the grammar uses an external XLE morphology, the morphcode is normally ‘XLE’, and when the grammar does not use external morphology, the star symbol ‘*’ is used. In the former case, the word form in the parse string is checked against morphological information coded in the morphology section, and the result is looked up in the lexicon. In the latter case, the lexicon entries will literally match with locally present tokens. A lexical entry may belong to more than one word category. For example, the English word *walk* can be V and N, thus this information is supplied as Cat1 and Cat2. A full lexical entry ends with a full stop, while different category specifications within the same entry are demarcated by a semicolon. In (329) we illustrate lexical entries in XLE for the words given in example (328).

(328) የኖስ ባናና በሊዑ ብ
 Yonas banana bälif-u
 Yonas.MSg banana.Sg PerfS.eat-SM.3MSg
 ‘Yonas ate a banana.’

(329) Lexical entries

```
የኖስ    N   *   (^ PRED)=‘የኖስ-Yonas’
          (^ NUM)=sg
          (^ CASE)=nom
          (^ GEND)=masc.
ባናና    N   *   (^ PRED)=‘ባናና-banana’
          (^ NUM)=sg.
በሊዑ    V   *   (^ PRED)=‘በሊዑ-eat<(^ SUBJ) (^ OBJ)>’
          (^ SUBJ NUM)=sg
          (^ SUBJ PERS)=3
          (^ SUBJ GEND)=masc
          (^ ASPECT)=perf.
```

Lexical entries in the current Tigrinya grammar are specified in their full forms since the grammar does not have external XLE morphology. Thus, morphological information such as NUM and GEND are given as f-structure annotations for each entry. Grammatical features that repeatedly occur in lexical entries can be generalized by the use of a template, which will be discussed in the following section 10.2.4.

10.2.4 TEMPLATES

Templates are a way of bundling f-structure annotations that are common to some rules and lexical entries. Templates help to generalize over grammatical specifications that a group of words may bear as a result of morphological affixes or semantic properties. The use of templates saves the grammar writer from repeatedly entering f-structure annotations for entries that have common grammatical properties. For example, the ($\hat{\text{NUM}}$)=sg and the ($\hat{\text{GEND}}$)=masc annotations in (329) can be shortened as in (330):

(330)

SG = ($\hat{\text{NUM}}$)=sg.
 M = ($\hat{\text{GEND}}$)=masc.
 F = ($\hat{\text{GEND}}$)=fem.

When these templates are called with the tags @SG, @M and @F, the functional annotations written after the equal sign will be factored out for the entries with which they are used. We can also call up already defined templates in order to bundle more features together, as in (331).

(331)

SG-M = @SG @M.
 SG-F = @SG @F.

Templates may also be used to generalize over grammatical features that are encoded by inflectional affixes. For example, Tigrinya verbs specify gender, number and person agreement values for the subject. The verb form በሊዮ *bäliŷ-u* is specified for a masculine, singular third person subject, and the verb form በሊዮ *bäliŷ-a* is specified for a feminine, singular third person subject. These features are coded by the two vowel patterns -u and -a in the simple perfective verb form. This information can be summarized in a template, as in (332).

(332)

U = (^SUBJ NUM)=sg
 (^SUBJ PERS)=3
 (^SUBJ GEND)=masc.
 A = (^SUBJ NUM)=sg
 (^SUBJ PERS)=3
 (^SUBJ GEND)=fem.

Templates may also contain parameters. For instance, we can specify entries of different noun types or subcategorization frames of different verb classes by providing their semantic predicate as a parameter at each invocation of a template. Each instance of a predicate will then appear in the semantic form of the PRED schema. For example, in (333) the parameter (P) is used to summarize the annotation of singular nouns and transitive verbs .

(333)

SG-N(P)= (^ PRED)='P'
 (^ NUM)=sg.
 TRANS-V(P)= (^ PRED)='P<(^SUBJ) (^OBJ)>'.

When the @TRANS-V(P) template is invoked in the lexicon for individual instances of transitive verbs subcategorized for a SUBJ and an OBJ, the particular instances of verbs will replace P. The lexicon is much more concise when repetitive details are summarized by means of templates, as shown in (334).

(334) Template invocation

የኃሰ N * @(SG-N የኃሰ-Yonas) @M.
 ሳባ N * @(SG-N ሳባ-Saba) @F.
 ባኖኖ N * @(SG-N ባኖኖ-banana).
 በሊፀ V * @(TRANS-V በሊፀ-eat) @U.
 በሊፃ V * @(TRANS-V በሊፀ-eat) @A .

Employing a template is also efficient since, when we need to modify specifications for the entries, we only have to make changes in the templates, and those changes will take effect in all the sections that employ those templates.

10.2.5 Parsing

Now that we have the main components in place, we will illustrate how parsing is done in the XLE system. First, we need to load the grammar in the XLE parser in order to parse. In Emacs we can choose ‘create a parser’ from the menu given

under LFG, and then we enter the file name of the grammar, for example, the demo grammar file name Tig-demo.lfg. After the grammar is loaded, XLE produces a process report, like the one given in Figure 10.2.

```
XLE loaded from /Users/nki001/xledir/bin/xle.
XLEPATH = /Users/nki001/xledir/bin.
Copyright (c) 1993-2001 by the Xerox Corporation and
Copyright (c) 2002-2008 by the Palo Alto Research Center.
All rights reserved. This software is made available AS IS,
and PARC and the Xerox Corporation make no warranty about
the software, its performance or its conformity to any specification.
XLE release of Feb 25, 2008 11:23.
Type 'help' for more information.
loading /Users/nki001/pargram/grammars/tigrinya/TIGRIGRAM.lfg...
Grammar has 26 rules with 257 states, 3877 arcs, and 48591 disjuncts (48591 DNF).
MORPHOLOGYCONFIGFILE = /Users/nki001/xledir/bin/default-morph-config.

Morph transducer files relative to /Users/nki001/xledir/bin/

0.25 CPU seconds
/Users/nki001/pargram/grammars/tigrinya/TIGRIGRAM.lfg loaded
Grammar last modified on Mar 07, 2011 17:29.
/Users/nki001/.xlerc loaded.
% |
```

Figure 10.2: XLE process report

The XLE process report contains information about the size of the grammar (26 rules with 257 states and 3877 arcs, etc.), among other things. The grammar loaded here is the actual Tigrinya grammar (TIGRIGRAM.lfg), not the demo grammar. When the process report says that the grammar files are loaded, the XLE buffer is ready to receive a sentence to be parsed at the prompt line indicated by the percent symbol % . At this command XLE returns a parsing report about the number of f-structure solutions, the computing time and the number of subtrees. A screenshot of the parsing report is shown in Figure 10.3.

```
% parse "ፎናስ ዓናና በሊዑ"
parsing {ፎናስ ዓናና በሊዑ}
1 solutions, 0.03 CPU seconds, 7 subtrees unified
1
%
:
```

Figure 10.3: XLE parsing message

In addition to this it produces the four separate parse windows for a c-structure tree, an f-structure, an f-structure chart and differences between solutions, as shown in Figure 10.4.

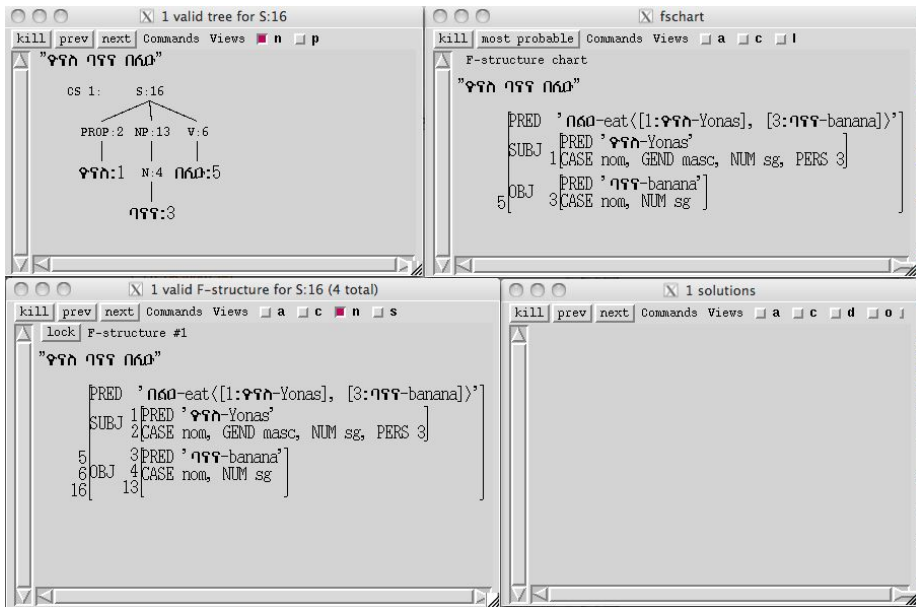

Figure 10.4: XLE parse window

The title bars of the c-structure and f-structure windows tell us that the parsed sentence has only one valid analysis. The fschart (f-structure chart) gives indexes of the packed solutions by their constraints. In this case, since the f-structure annotations assigned to the parsed sentence do not contain competing constraints, there are no indexed constraints in the fschart window. Thus, the fschart window prints the same analysis as in the f-structure window. Similarly, since there are no indexed ambiguous constraints, we do not get any alternative solutions of indexed constraints in the solutions window.

In the following section we will present the implementation of the Tigrinya grammar. Screenshots of parsed outputs from XLE-Web will be used to illustrate the analyses of the phenomena being discussed.

10.3 The nominal phrase in Tigrinya

The nominal phrase is predominantly a head-final structure. Noun specifiers and modifiers precede their head, except in the N-N modification structure. The NP rule in (335) shows that the noun head can be modified by an optional relative complement, possessive or adjective phrase.

(335)

NP --> (CPrel: (^ ADJUNCT)),
 (POSS: (^ SPEC)=!),
 (AP*: (! \$ (^ ADJUNCT)));
 Nhead: ^=!

The different modifiers are not ordered with respect to each other. The order they follow here is their default position, although they can shift position in order to mark different pragmatic readings. Here we will illustrate the default order only. The different modifiers can be expanded as follows.

(336)

AP --> (Adv*: (^ ADJUNCT))
 @CONCORD
 A: ^=!

In Tigrinya most adjectives are inflected for gender and number. In addition, some intensifying adverbs bear pronominal agreement marking for gender, number and person (e.g. ኣዝዩ ገላዝያ-ä 'Very much I', ኣዝዮም ገላዝያ-om 'very much they (masculine)' etc.). These adverbs therefore need to agree with the adjective, and the adjective phrase has to agree with the noun head. This is taken care of by the concord @CONCORD template which contains the following constraints (337).

(337)

CONCORD = (! NUM)=(^ NUM)
 (! GEND)=(^ GEND)
 (! PERS)=(^ PERS).

In order to parse a noun phrase such as the one given below (338), we need to enter each word that constitutes this phrase in the lexicon section, as shown in (339).

(338) ኣዝዩ ኣብቕደስት ገላ
 ገላዝያ-*a* ሻብቅ-*ti* ገላ^w*al*
 very-3FSg beautiful-FSg girl.FSg
 'very beautiful girl'

(339)

- አዝያ** ADV * (^ PRED)='አዝያ-very-much'
@F-SG-3.
- ጽብኛቲ** A * (^ PRED)='ጽብኛ-good/beautiful'
@F-SG.
- ጎል** N * (^ PRED)='ጎል-girl'
@F-SG (^ ANIM)=+
(^ NTYPE NSEM COMMON)=count
(^ NTYPE NSYN)=common.

We annotate animate and inanimate nouns with (^ ANIM)=+ and (^ ANIM)=- to capture that fact that inanimate plural nouns can agree with a singular masculine determiner, adjective or verbal pronominal affix in order to express a collective reading of a noun (refer to chapter 2.3.1 for a discussion of number agreement in Tigrinya). In addition, nouns are also annotated as common, and as either count or mass. Given the rules and lexical entries above, we can show the c-structure tree and f-structure analysis of the noun phrase given above in Figure 10.5.

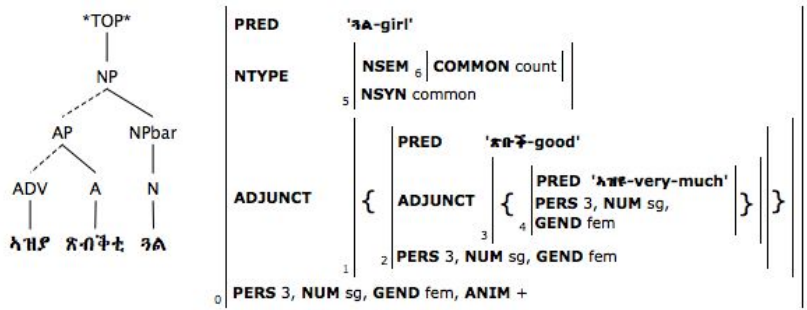

Figure 10.5: NP with AP

The noun phrase can also contain a possessive specifier. The possessive reading can be expressed either through independent possessive pronouns or possessive pronominal suffixes which optionally agree with an overt possessor nominal. We provide some lexicon entries in order to illustrate possessive specifiers below.

(340) Possessive expression

ናተይ	POSS	*	([^] PRED)='pro' ([^] NUM)=Sg ([^] PERS)=1 ([^] DEF)=+ ([^] PRON-TYPE)=poss ([^] POSS-FORM)=natey {([^] PRED)='pro'}
መጽሐፍ	N	*	([^] PRED)='መጽሐፍ-book' @SG ([^] ANIM)=- ([^] NTYPE NSEM COMMON)=count ([^] NTYPE NSYN)=common.
መጽሐፈይ	N	*	([^] PRED)='መጽሐፍ-book' @SG ([^] ANIM)=- ([^] NTYPE NSEM COMMON)=count ([^] NTYPE NSYN)=common {([^] SPEC POSS PRED)='pro' ([^] SPEC POSS PRED FN) ([^] SPEC POSS CASE)=c obj } ([^] SPEC POSS NUM)=Sg ([^] SPEC POSS PERS)=1 ([^] SPEC POSS AGR)=+ ([^] SPEC POSS DEF)=+ ([^] SPEC POSS POSS-FORM)=pronominal.

The possessive pronoun specifies a possessum noun. The possessive pronoun is realized as a daughter of the NP, and it projects the information about the possessor into the grammatical function POSS(essor) in the mother's f-structure. The possessum noun can also be dropped, and in this case, the possessive pronoun provides a PRED which is expressed as an optional annotation {([^] PRED)='pro'}.

The c-structure and f-structure analysis of a possessive expression with a possessive pronoun (341) is shown in Figure 10.6.

- (341) ናተይ መጽሐፍ
 nat-äy mäṣḥaf
 POSS.1Sg book.Sg
 'my book'

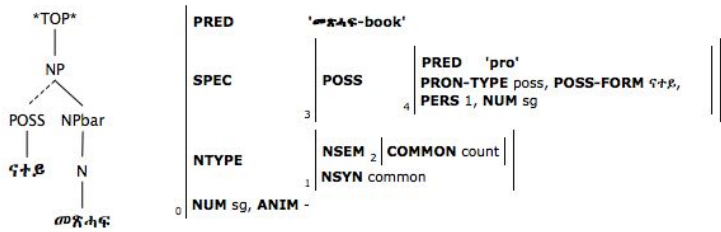

Figure 10.6: NP with a possessive pronoun

When the possessor is expressed through a pronominal suffix, information about the possessor is expressed on the head noun through the functional annotation (^SPEC POSS)=!. In this regard, the possessive pronominal suffix acts as an incorporated pronoun. Thus, it follows from principles of completeness and coherence that the suffix contributes a referential PRED provided by the annotation (^SPEC POSS PRED)='pro'. The c-structure and f-structure in Figure 10.7 illustrate the analysis of the possessive expression via a possessive pronominal (342).

- (342) መጽሐፍይ
 mäṣḥaf-äy
 book.Sg-Poss.1Sg
 'my book'

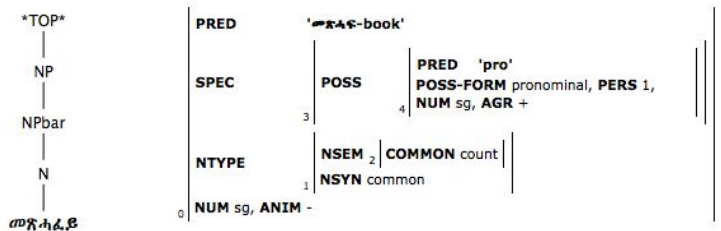

Figure 10.7: NP with possessive pronominal suffix

The possessive pronoun and the possessive suffix cannot coexist since the possessive pronominal suffix cannot corefer with an overt possessive pronoun. An expression that contains these two possessive expressions will get an f-structure analysis where the two possessive expressions provide conflicting specifier PREDs in the f-structure of the POSS.

On the other hand, the pronominal suffix can correspond to an overt nominal expression which is obligatorily marked with the objective case (343). This is taken care of by constraining this predicate form to be in the objective case. In this case,

the possessive suffix acts as a mere agreement marker, and thus it does not contribute a referential PRED in the f-structure of the POSS. The PRED feature in this structure is supplied by the possessor nominal ንዓይ *ni-ʕay* ‘to me’ which must agree with the possessive pronominal suffix marking the possessee nominal to yield the possessive reading, as shown in Figure 10.8.

- (343) ንዓይ መጽሐፈይ
 ni-ʕay məṣḥaf-äy
 Obj-Pro.3MSg book.Sg-Poss.1Sg
 ‘to me, my book’

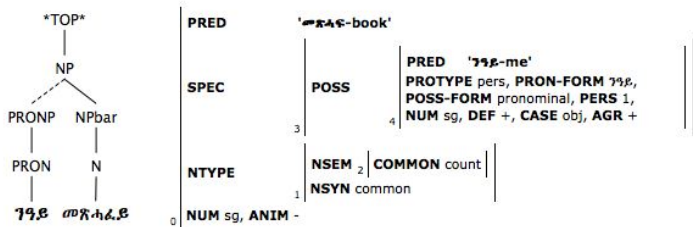

Figure 10.8: Nominal possessor expression

The possessor nominal should agree with the pronominal suffix that marks the possessum expression. Here the objective pronoun form ንዓይ *ni-ʕa-y* ‘to-Pro-1Sg’ has the same agreement features as the pronominal suffix -äy that marks the possessum noun məṣḥaf ‘book’.

Like other modifiers, the relative clause also precedes the noun it modifies. The relative reading is morphologically expressed through a suffix, for example ዝ *zi-*, which may attach to a verb, as shown below (344), or to a noun. Tigrinya does not have independent relative pronouns such as *that, who, whom, whose*, etc. The relative suffix ambiguously marks these different readings. Like other main verbs, the relative verb obligatorily bears a subject suffix. It may also bear an object suffix for a relativized definite object. The relative clause is treated as an instance of long distance dependency since there is dependency between the relativized element and the arguments of the relative verb. This is illustrated through the c-structure and f-structure analyses given in Figure 10.9.

- (344) ተስፋይ ዚገዛእ መጽሐፍ
 täsfay zi-gäz?-a məṣḥaf
 Tesfay Rel-PerfS.buy.SM.3MSg-OM₁-3FSg book.Sg
 ‘(the) book that Tesfay bought’

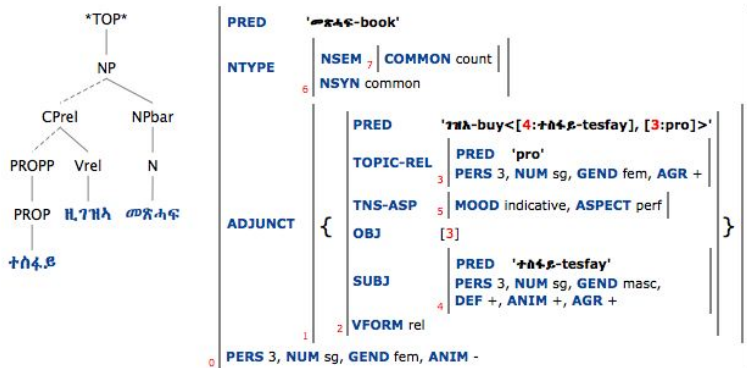

Figure 10.9: NP with a relative modifier

This dependency is expressed in the f-structure by associating the object that corresponds to the relativized element with the discourse function TOPIC-REL. In Tigrinya the grammatical function information is supplied by the pronominal suffixes for the object function of the relative verb.

Determiners are realized at the leftmost position in the nominal structure. The c-structure and f-structure analyses of the determiner phrase in (345) is presented in Figure 10.10.

- (345) እታ ተስፋይ ዚገዝእ ጽብቕቲ መጽሐፍ
 ?it-a täsfay zi-gäz?-a şibiq-ti maşhaf
 Det-3FSg Tesfay Rel-PerfS.buy.SM.3MSg-OM₁.3FSg nice-SgF book.Sg
 ‘The nice book that Tesfay bought’

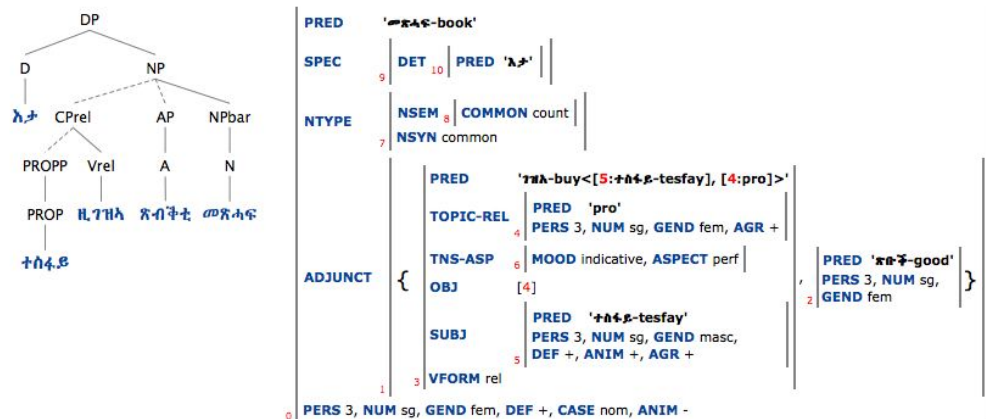

Figure 10.10: A determiner phrase

The phrase that contains the determiner is identified as a DP. The determiner is analyzed as the functional head of the DP constituent and the noun it specifies is the lexical head of the phrase. In the f-structure the adjectival and the relative modifiers are presented as members of the set value of the ADJUNCT function, whereas the determiner provides the SPEC function.

In this section we have outlined the analyses given to the various modifiers and specifiers in our implementation. In the following section we will present the implementation of the basic clause in Tigrinya.

10.4 The simple clause

The implemented grammar currently can account for simple clauses. The implementation takes into consideration most of the grammatical properties of Tigrinya discussed in chapter 2. However, here we will only focus on the basic components of a simple clause. This will help us to lay the ground for the implementation of the phenomena dealt with in this thesis. The default word order in Tigrinya is identified as SOV; however, this order can vary according to different pragmatic or discourse contexts (refer to chapter 2.5 for a brief description of Tigrinya simple clauses). We assume a flat phrase structure for Tigrinya, which entails that the verb, its sub-categorized arguments and adjuncts all occur at the same level dominated by an exocentric S. The following rule encodes a simple Tigrinya clause.

(346) S --> NOM*, PP*, V.

The meta-category NOM is used to generalize over the nominal categories that serve as arguments of the verb. It is defined as a set of alternative values, as shown in (347).

(347) NOM={ NP | DP | QP | PRON | PROP | PRO-INT }

NOM can take any of the categories in the set as its value. NOM is marked with a Kleene star because the verb can have zero or more overtly realized arguments. A clause can also have one or several prepositional phrases (PP). The comma between categories is a shuffling operator which shuffles the ordering of the constituents. Since not all word order possibilities that are generated by this rule are allowed in the language, the grammar imposes constraints as f-structure annotations in order to rule out ungrammatical structures. For example, in Tigrinya only definite objects can precede the subject. This condition is stated as follows.

(348)

S --> NOM*: { (^ SUBJ)=!
 (! CASE)=nom
 | (^ OBJ)=!
 {~(! DEF)=+
 ~(^ OBJ) <h (^ SUBJ)
 (!CASE)= “condition one”
 |(! DEF)=+
 (! CASE)=c obj
 (! AGR)=c + } }, “condition two”
 V: ^=!

Subjects and unmarked objects are assigned a nom(inative) case. Unmarked objects are not allowed to precede the subject (condition one). On the other hand, definite objects are required to be marked with the objective case and agree with the verb. When objects are marked in this manner (condition two), they can leave their canonical position and be preposed before the subject or postposed after the verb. Subjects and unmarked objects should occur in the word order shown in (349a). In this structure neither noun phrase distinguished by case marking, and the verb marks the subject only. Thus, if we switch the order, as in (349b), the clause becomes ungrammatical. In order for the the proper noun *Tesfay* to be coded as an object, it must bear the objective case in this position. The noun *book* cannot be semantically selected as head of a subject.

- (349) a. ተስፋይ መጽሐፍ ገዘኑ ።
 täsfay məṣḥaf gäzi?-u
 Tesfay.M book.Sg PerfS.buy.SM.3MSg
 ‘Tesfay bought a book.’
- b. *መጽሐፍ ተስፋይ ገዘኑ ።
 məṣḥaf täsfay gäzi?-u
 book.Sg Tesfay.M PerfS.buy.SM.3MSg
 ‘Tesfay bought a book.’

A sentence with an unmarked subject and object, as in (349a), will get the c-structure and f-structure analysis in Figure 10.11. However, the clause with a preposed object (349b) will not be parsed.

Since indefinite objects, like subjects, are unmarked for case, the CASE feature of both the SUBJ and the OBJ attributes has a nom(inative) value.

When the object is definite, it is case marked and cross-referenced on the verb (350a), and in this structure the object can be fronted (350b).

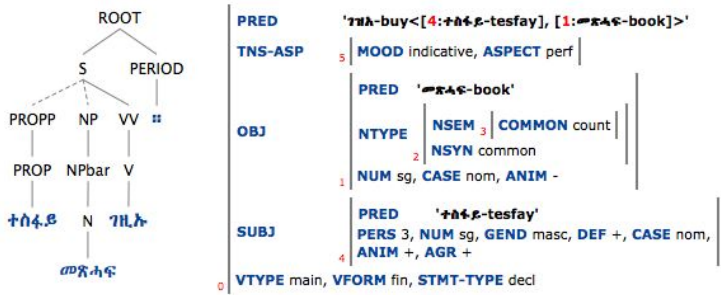

Figure 10.11: An unmarked clause

- (350) a. **ተስፋይ ነታ መጽሐፍ ገዘሉዋ ።**
 täsfay n-ät-a mäṣḥaf gäzi?-u-wa
 Tesfay.MSg Obj-Det-3FSg book.Sg PerfS.buy-SM.3MSg-OM₁.3FSg
 ‘Tesfay bought the book.’
- b. **ነታ መጽሐፍ ተስፋይ ገዘሉዋ ።**
 n-ät-a mäṣḥaf täsfay gäzi?-u-wa
 Obj-Det-3FSg book.Sg Tesfay.MSg PerfS.buy.SM.3MSg-OM₁.3FSg
 ‘The book, Tesfay bought it.’

Essentially, the elements in the clause can occur in any order, such as OSV, SVO, VSO, VOS and OVS. Furthermore, neither the subject nor the object needs to be overtly realized in the clause. The morphological information expressed by the verbal object suffix (OM₁) is given in the template section, as in (351).

(351)

- WA = (^ OBJ GEND)=fem
 (^ OBJ NUM)=sg
 (^ OBJ PERS)=3
 (^ OBJ AGR)=+
 { (^ OBJ PRED FN)=c pro
 | ~ (^ OBJ PRED FN)=pro
 (^ OBJ DEF)=c +
 (^ OBJgoal CASE)=c obj }

The annotation for WA contains constraining equations that state the conditions for its realization, in addition to the specifications of agreement information. The object marked with this suffix either has a PRED feature which has a ‘pro’ as its value, or it has an overt semantic form as its value, thus it is not a ‘pro’. In the later case, OBJ must be definite. This constraint expresses the interdependence of the object verbal suffix and the definiteness feature. The c-structure representations

for sentence (350a) and sentence (350b) are given in Figure 10.12.

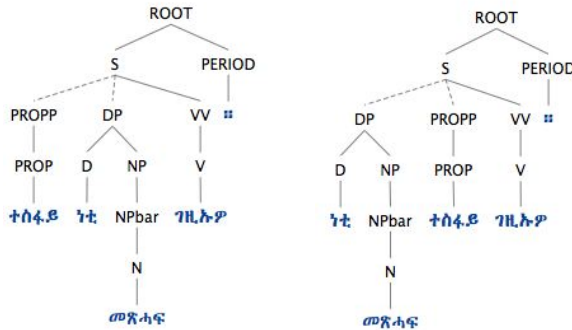

Figure 10.12: C-structures with definite objects

Since the grammar currently does not provide discourse/pragmatic function analyses for the different discourse/pragmatic readings coded by these word orders, the two c-structure representations correspond to the same f-structure analysis shown in Figure 10.13.

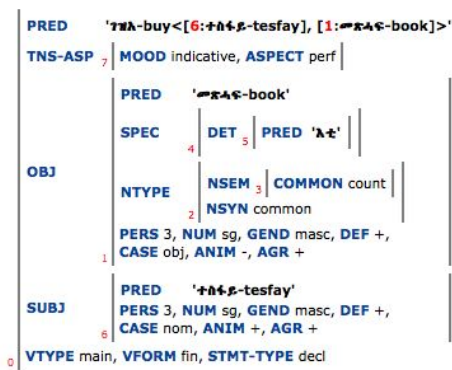

Figure 10.13: F-structure with definite object

When the object is definite the f-structure contains an AGR (agreement) feature with a + value, and a CASE feature with obj as its value. The agreement suffixes bear the annotation (^ OBJ AGR)=+ which is checked by the constraining equation (! AGR)=c + given as an annotation of a definite OBJ in the c-structure.

The nominals that express the subject and the object can also be dropped, leaving only the verb (352).

- (352) **ገዚአዎ ።**
 gäzi?-u-wo
 PerfS.buy.SM.3MSg-OM₁.3MSg
 ‘He bought it.’

In this case, the arguments of the predicate are satisfied by a phonologically null category ‘pro’, which is a functional specification of the pronominal arguments to which the inflection suffixes of the verb are bound. The c-structure and f-structure representation for pro-dropped subject and object functions are given in Figure 10.14. In the c-structure there are no nodes to represent either a subject or

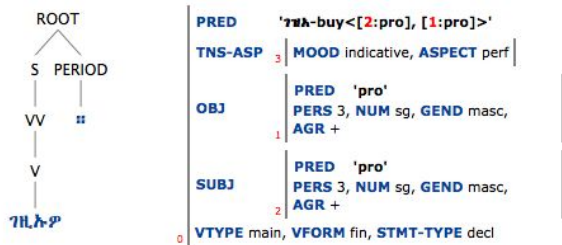

Figure 10.14: Pro-drop

an object, while the f-structure contains SUBJ and OBJ attributes with the PRED feature that has a null ‘pro’ as its value. It is a null ‘pro’ in the sense that it does not correspond to a c-structure node. The GEND, NUM and PERS features acquire their values from the verbal pronominal suffixes.

The number and type of arguments that verbs may take is expressed in the lexicon for each verb entry. The lexicon contains representative verb entries from different verb classes. These entries are marked with template macros that define their subcategorization frames. The templates section contains a definition of subcategorization frames for different verb types such as intransitive, transitive, ditransitive, locative verbs, etc. Below we list some of these (353).

(353)

V-INTRANS (P)	=	([^] PRED)=‘P(<([^] SUBJ)>’ { ([^] SUBJ PRED)=‘pro’ } .
V-TRANS (P)	=	([^] PRED)=‘P(<([^] SUBJ) (<([^] OBJ)>’ { ([^] SUBJ PRED)=‘pro’ } { ([^] OBJ PRED)=‘pro’ }
V-DITRANS (P)	=	([^] PRED)=‘P(<([^] SUBJ) (<([^] OBJ) (<([^] OBJgoal)>’ { ([^] SUBJ PRED)=‘pro’ } { ([^] OBJ PRED)=‘pro’ } { ([^] OBJgoal PRED)=‘pro’ }.
V-TRANS-OBL-loc (P prp)	=	([^] PRED)=‘P(<([^] SUBJ) (<([^] OBJ) (<([^] OBL-loc)>’ ([^] OBL-loc PFORM)=c prp { ([^] SUBJ PRED)=‘pro’ } { ([^] OBJ PRED)=‘pro’ }.

A template is invoked by its name, which is the part on the left-side of the entry before the equal sign. The different subcategorization frames contain parametrized macro (e.g. P and P prp) definitions whose values are determined by the call of individual verb entries that reflect the appropriate subcategorization frame. For example, when the template macro @V-TRANS is invoked with transitive predicates such as **ገዘኡዎ** *gäzi?-u-wa* ‘he bought it’ in (354), the system will find the template definition and will copy the annotations coded by it into the place of the macro call.

(354)

ገዘኡዎ V* @ (V-TRANS **ገዘኡ**-buy)
 @U @WA @
 ([^] VFORM)=fin ([^] VTYPE)=main
 @PERFECT-GERUND.

The templates @U and @WA are called to access the agreement feature for the subject and the object, respectively. Information about tense and aspect is also annotated on the verb. Verbs are also annotated as to whether they are finite or not, and main or not.

In addition to SUBJ and OBJ, some verbs are subcategorized for OBL_θ functions (in chapter 6.2 we discuss the distinction between obliques and adjuncts). OBL_θ functions are semantically restricted to given semantic roles. The different semantic relations are indicated by distinct prepositions, for example, the locative preposition *?ab* and the instrumental preposition *bi*. In (355) the verb *load* selects a semantically marked OBL that is associated with a locative argument.

- (355) ተስፋይ ነቲ ንክሊ ኣብ ኣታ ኣድገ
 täsfay n-ät-i ?ikili ?ab ?it-a ?adgi
 Tesfay.MSg Obj-Det-3MSg grain.Sg on Det-3FSg donkey.Sg
 ባህሪ ስብስብ ስ
 şifin-u-wo
 PerfS.load.SM.3MSg-OM₁.3MSg
 ‘Tesfay loaded the grain on the donkey.’

The f-structure associated with the PP *?ab ?it-a ?adgi* ‘on the donkey’ is assigned a PRED value to express the fact that the preposition that marks this OBL function has semantic content. Such an analysis is achieved by using the rules given below (356).

- (356)
- | | | | |
|----|-----|-------|--------------------------------|
| S | --> | NOM*: | { (^ SUBJ)=!
 (^ OBJ)=! }, |
| | | PP* : | (^ (! PCASE))=!, |
| | | V : | ^=! |
| PP | --> | P : | ^=! |
| | | | (^ PTYPE)=c sem |
| | | NOM: | (^ OBJ)=! |

The annotated (^ (! PCASE))=! gives the attribute of which the PP’s f-structure is a value. OBL functions are semantically restricted to prepositions that head the PP. Thus, the lexical entry of the individual preposition supplies the specific instantiation of PCASE. We illustrate this with the entry of the locative preposition (357).

- (357)
- | | | | |
|----|---|---|---------------------------|
| ኣብ | P | * | (^ PCASE)=OBL-loc |
| | | | (^ PRED)='ኣብ-ab<(^ OBJ)>' |
| | | | (^ PFORM)=ኣብ |
| | | | (^ PSEM)=loc |
| | | | (^ PTYPE)=sem |

PCASE will be instantiated to OBL-loc, which will appear as the f-structure attribute. Similarly, all semantically restricted distinct prepositions will contribute the semantic case that mark OBL functions. This makes it possible to avoid annotating the PP in the c-structure with all the different OBL functions (Falk 2001:75). In order to be able to parse the sentence in (355), we will need to specify the lexical entry for the locative verb *şifin in-u-wo* ‘he loaded it’.

(358)

ጸግጉዎ V * @ (V-TRANS-OBL-loc ጸግጉ-load ኣብ-loc-prep)
 @U @WO
 @PERFECT-GERUND
 (^ VFORM)=fin (^ VTYPE)=main.

In the context of the clause that we want to parse, the verb will invoke the subcategorization frame for locative arguments. Alternatively, it can also be associated with another subcategorization frame where the locative is applicatively expressed. This will be discussed in subsequent sections. Here we will focus on the analysis of the OBL function. In a clause with a prepositional locative the object marker -wo (OM₁) cross-references with the theme object. The c-structure and f-structure analyses of the sentence with the locative OBL (355) is given in Figure 10.15.

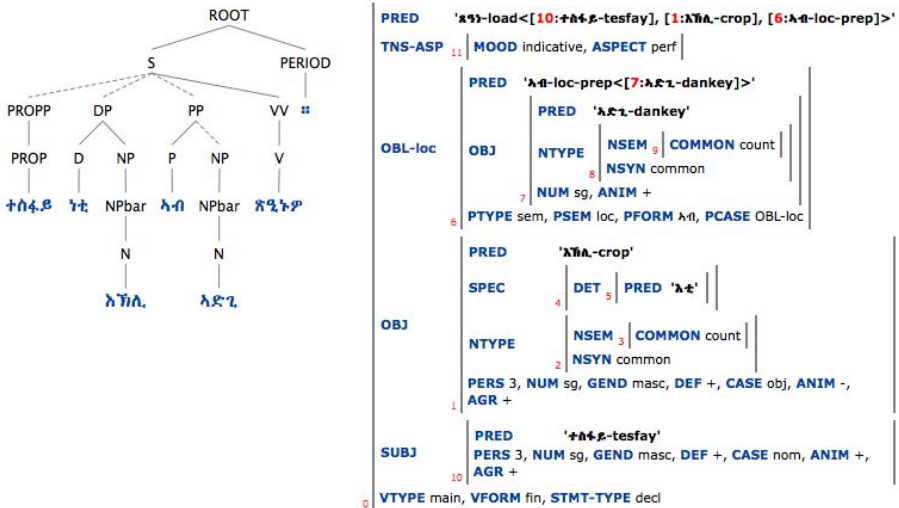

Figure 10.15: Agreement with OBJ

OBL-loc is featured by the locative preposition within the argument structure of the main PRED together with the other governable grammatical functions such as SUBJ and OBJ. Since the preposition is the head of a phrase, the OBL-loc has the locative preposition and its subcategorization frame as the value of its PRED feature. The object of the preposition appears in the same f-structure as the PRED, as required by the completeness condition of LFG. In the following section we will present the analysis of the passive clause.

10.5 The passive clause

The Tigrinya grammar also accounts for operations that alter the alignment of grammatical functions to the arguments in the subcategorization frame of the verb. Here we will illustrate the implementation of the passive because we have used this phenomenon as a diagnostic for objecthood in applicative clauses. As noted earlier, passivization is morphologically coded in Tigrinya. For example, in the perfective aspect the verb is marked with the prefix *tä-* to derive the passive reading, as in (359).

- (359) እታ መጽሓፍ ተገዘአ።
 ?it-a mäṣṣaf tä-gäziʔ-a
 Det-3FSg book.Sg DT-PerfS.buy.SM.3FSg
 ‘The book has been bought.’

The passive predicate is associated with the same subcategorization frame as the active verb. Thus, the passive predicate *tä-gäziʔ-a* ‘it has been bought’ uses the template invocation @(V-TRANS ገዘአ-buy) as its active counterpart in (354). Passive predicates are annotated with ([^]PASSIVE)=+, a feature that effects the passive rule. The lexical rule will realign the initial arguments of a predicate to grammatical functions according to the pattern coded by the passive. The template definition of the passive given below characterizes the passive pattern in Tigrinya (360).

(360) Passive lexical rule

PASS (SCHEMATA) = { ~([^]PASSIVE)=+
 SCHEMATA “nothing happens”
 | ([^]PASSIVE)=c +
 SCHEMATA “passive operates”
 {([^]OBJ) --> ([^]SUBJ)
 | ([^]OBJgoal) --> ([^]SUBJ)}
 { ([^]SUBJ) --> NULL
 | ([^]SUBJ) --> ([^]OBL-AG)
 ([^]OBL-AG CASE)=c instr}.

In this template, SCHEMATA is used as a parameter which takes the template definition of a verb subcategorization frame such as those given in (353) as its input. This is illustrated by the subcategorization frame of a transitive predicate (361).

(361)

V-TRANS (P) = (PASS [([^]PRED)=‘P<([^]SUBJ) ([^]OBJ)’
 { ([^]SUBJ PRED)=‘pro’ }
 { ([^]OBJ PRED)=‘pro’ }]).

When an active predicate appears in place of the P, the passive rule will not perform any remapping, but when a passive predicate appears in place of the P, the rule will perform the remapping operation. The rewriting symbol (\dashrightarrow) indicates that a logical object, i.e. the argument that corresponds with a theme/patient semantic role, or the goal/recipient object of a ditransitive clause will be rewritten as a SUBJ function when the passive rule is applied. In the subcategorization frame the designators SUBJ and OBJ correspond to the default arguments of an active predicator. The passive rule takes the initial syntactic arguments (i.e arguments of the active predicate), and realigns them with the pattern coded by the passive. The initial subject is either phonologically unexpressed (NULL), or it is realized as an OBL-AG(ent) function, which in Tigrinya is marked by an instr(umental) prepositional case. The c-structure and f-structure representations in Figure 10.16 are given to the passive sentence in (359). Since, in this passive expression, the agent argu-

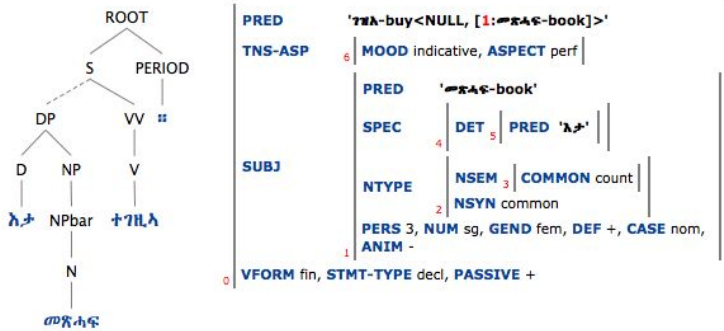

Figure 10.16: Passive of transitive predicate

ment is not syntactically realized, the absence of the agent argument (the logical subject) is indicated by the NULL symbol in the f-structure. The theme argument assumes the SUBJ function, which is evidenced by the subject pronominal suffix that it cross-references with and the nominative form of the determiner that specifies it.

10.6 Applicative clauses

In this section we will present the implementation of three types of clauses. The first type involves inherent ditransitive verbs that are subcategorized for two objects. The second type involves transitive base verbs that are subcategorized for applied objects through the suffix OM₂. The third type involves intransitive predicates that

can host either OM₁ or OM₂ to express different semantic role readings of the applied argument.

10.6.1 Analysis of ditransitive clauses

As discussed earlier (8.2.1 and 8.3.1), objects in ditransitive clauses are coded through an interplay of word order, case and pronominal marking. In a ditransitive clause the two objects are not strictly ordered with respect to each other. Depending on whether the theme object is definite or not, we get different word order constraints. (1) When the theme object is indefinite, the default order is one in which the theme follows the recipient object. However, that order can be reversed to express a contrastive focus reading of the theme object. In this structure, only the recipient object can be pronominally marked, depending on its salience in the discourse context. (2) When the theme object is definite, it obligatorily precedes the recipient object, and either of these objects can be selected for pronominal marking. The c-structure rule in (362) captures these word order patterns of objects in ditransitive clauses. It is an expansion of the rule which was given in (348) in order to include f-structure annotations and constraints to capture the structure of the ditransitive clause. The functions OBJ and OBJgoal correspond to theme argument and recipient arguments, respectively. As noted in (8.5), OBJgoal is semantically restricted to the goal semantic role. It reflects the same primary objecthood properties as the theme OBJ function with respect to passivization.

(362)

S	--> NOM*:	{ (^ SUBJ)=!	(! CASE)=nom
		(^ OBJ)=!	{ {~(! DEF)=c+ “Condition 1”
			~(^ OBJ) <h (^ SUBJ)
			(!CASE)=nom
			(! DEF)=+ “Condition 2”
			(! CASE)=c obj
			(! AGR)=c +}
			(^ OBJgoal) “Condition 3”
			(! DEF)=c +
			~(^ OBJgoal) <h (^ OBJ)}
		(^ OBJgoal)=!	(^ OBJgoal CASE)=c obj},
V:		^=!	

The S rule in (348) includes the ($\hat{\text{OBJgoal}}=!$) annotation, in addition to the SUBJ and OBJ, for the meta-category NOM* in order to license object arguments of ditransitive predicates. The equation ($\hat{\text{OBJgoal CASE}}=c \text{ obj}$) constrains OBJgoal to obligatorily bear the objective case marking. Generally, OBJ and OBJgoal are not ordered with respect to each other, but when OBJ is definite, it obligatorily precedes OBJgoal and bears case marking. This word order phenomenon, known also as ‘word order freezing’ (see chapter 8.2.1), is expressed as a condition (Condition 3) under the annotation of OBJ through the head precedence constraint. The head precedence rule restricts the head of the OBJgoal function from preceding the head of the OBJ function in c-structure. The head in this constraint refers to the constituent that corresponds with the f-structure where the semantic form ‘PRED’ is instantiated.

In addition to the annotated rules, ditransitive predicates are also supplied with information about their subcategorization pattern, sub-lexical rules that direct the linking of argument to relevant grammatical function in voice altering phenomena (such as the template tag @PASSIVE), and agreement patterns (such as those given as template tags @U and @WA), among other things. This information is provided in the lexical entries of the verbs. The lexical entries for the active and passive forms of a ditransitive predicate are given (363).

(363) Ditransitive lexical entry

ሂቡዎ	V	*	@(V-DITRANS ሂቡ-give) @U @WA @PERFECT-GERUND ($\hat{\text{VFORM}}=fin \hat{\text{VTYPE}}=main.$)
ተዋሂቡዎ	V	*	@(V-DITRANS ሂቡ-give) @U @WO @PASSIVE @PERFECT-GERUND ($\hat{\text{VFORM}}=fin \hat{\text{VTYPE}}=main.$)

In the grammar, lexical entries are listed in their full morphological form. Inflectional and derivational patterns of verbs are generalized in the template section, and thus lexical entries are marked with template tags that define these patterns. Both object arguments of ditransitive predicates are identified with the same verbal suffix (OM₁) as the object argument in monotransitive predicates, thus the template tags @WA and @WO may be associated with either object, OBJ or OBJgoal. In order to illustrate this, we will extend the template definition for the third person feminine object pronominal suffix which was given in (351) to include the agreement specification for OBJgoal, as in (364).

(364) Cross-referencing with OBJ or OBJgoal

$$\begin{aligned}
 \text{WA} = & \{ (\hat{\text{OBJ GEND}})=\text{fem} \\
 & (\hat{\text{OBJ NUM}})=\text{sg} \\
 & (\hat{\text{OBJ PERS}})=3 \\
 & (\hat{\text{OBJ AGR}})=+ \\
 & \{ (\hat{\text{OBJ PRED FN}})=\text{c pro} \\
 & | \sim (\hat{\text{OBJ PRED FN}})=\text{c pro} \\
 & (\hat{\text{OBJ CASE}})=\text{c obj} \\
 & (\hat{\text{OBJ DEF}})=\text{c +} \} \\
 & | (\hat{\text{OBJgoal GEND}})=\text{fem} \\
 & (\hat{\text{OBJgoal NUM}})=\text{sg} \\
 & (\hat{\text{OBJgoal PERS}})=3 \\
 & (\hat{\text{OBJgoal AGR}})=+ \\
 & \{ (\hat{\text{OBJgoal PRED FN}})=\text{c pro} \\
 & | \sim (\hat{\text{OBJgoal PRED FN}})=\text{c pro} \\
 & (\hat{\text{OBJgoal CASE}})=\text{c obj} \\
 & (\hat{\text{OBJ DEF}})=\text{c +} \} \}.
 \end{aligned}$$

This template definition given in the form of two disjunctions specifies that the object suffix OM_1 , here instantiated by the third person feminine form (WA), can correspond to either OBJ or OBJgoal. In addition, the marker is specified either as an agreement marker or a pronominal suffix in the absence of overt expressions for these arguments. When the expression of OBJ or OBJgoal is overtly realized, i.e., not a ‘pro’ ($\sim(\hat{\text{OBJ PRED FN}})=\text{c pro}$ or $\sim(\hat{\text{OBJgoal PRED FN}})=\text{c pro}$), the overt expression is required to be definite ($(\hat{\text{OBJ DEF}})=\text{c +}$ or $(\hat{\text{OBJgoal DEF}})=\text{c +}$), and bear the objective case suffix ($(\hat{\text{OBJ CASE}})=\text{c obj}$ or $(\hat{\text{OBJgoal CASE}})=\text{c obj}$).

Now that we have the syntactic rules along with their functional annotations and lexical descriptions in place, we will demonstrate how ditransitive clauses are parsed by the grammar. The following example (365) involves an indefinite theme object and a definite recipient object in their neutral order.

(365) የሩሳስ ንሳባ መጽሐፍ ሂቡ-ዋ ።
 Yonas n-saba mäṣḥaf hib-u-wä
 Yonas.M Obj-Saba book.Sg PerfS.give-SM.3MSg-OM₁.3FSg
 ‘Yonas gave Saba a book.’

The object suffix cross-references with the recipient object. The two objects can also switch position in order to code a different pragmatic reading, i.e. a contrastive focus reading of the theme object. The two c-structure representations are given in Figure 10.17.

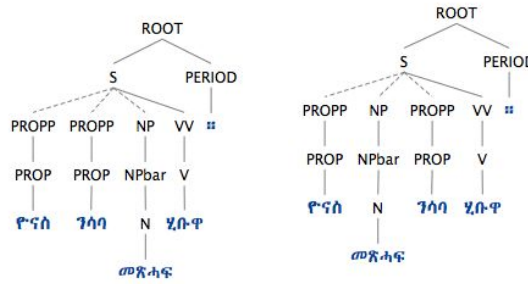

Figure 10.17: C-structure - ditransitive with indefinite OBJ

The c-structure on the left shows the neutral order, with the recipient object preceding the theme object, and the one on the right shows the switched order. The f-structure representation for the two c-structures is the same, as shown in Figure 10.18, since our grammar does not give different representations for the information structure reading that the two clauses encode at this point.

PRED	'መጽሐፍ-give<[5:ፊናስ-yonas], [1:መጽሐፍ-book], [4:ሳባ-saba]>'
TNS-ASP	MOOD indicative, ASPECT perf
OBJgoal	PRED 'ሳባ-saba' PERS 3, NUM sg, GEND fem, DEF +, CASE obj, ANIM +, AGR +
OBJ	PRED 'መጽሐፍ-book' NTYPE NSEM 3 COMMON count NSYN common NUM sg, CASE nom, ANIM -
SUBJ	PRED 'ፊናስ-yonas' PERS 3, NUM sg, GEND masc, DEF +, CASE nom, ANIM +, AGR +
VTYPE	main, VFORM fin, STMT-TYPE decl

Figure 10.18: F-structure - ditransitive with indefinite OBJ

The attribute-value pair AGR + in the subsidiary f-structure that is the OBJgoal [AGR +] codes that it is the OBJgoal that cross-references with the object suffix in this clause. When the theme object is definite, the order of the objects becomes fixed, as in (366).

- (366) ፊናስ ነቲ መጽሐፍ ንሳባ ሂቡዋ ።
 Yonas n-ät-i mäṣḥaf n-saba hib-u-wä
 Yonas.M Obj-Det-3MSg book.Sg Obj-Saba.F PerfS.give-SM.3MSg-OM₁.3FSg
 ‘Yonas gave Saba the book.’

Both objects bear the obj(ective) case marker, therefore they can only be distinguished by their word order. The grammar assigns only one c-structure analysis in which the theme object precedes the recipient object, as in shown in Figure 10.19.

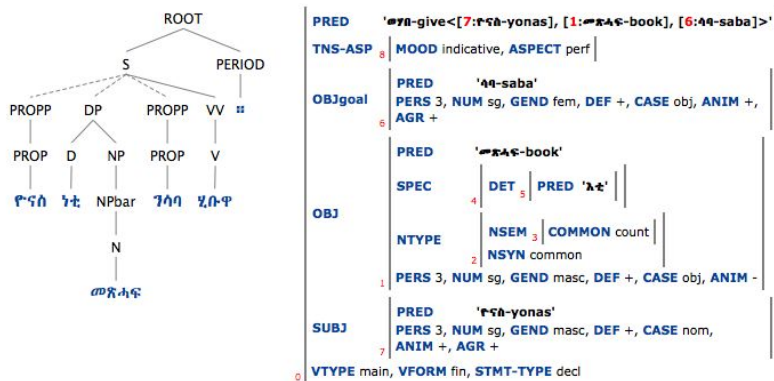

Figure 10.19: Definite theme objects in ditransitive clause

The object verbal suffix can cross-reference with either of the objects when both are definite, given that they code the same agreement features. In (366) it is the OBJgoal that shows agreement with the verb, as is shown by the [AGR +] listed under OBJgoal function.

When the two objects reflect the same agreement features as the object suffix, the suffix becomes ambiguous, and a clause with these properties gets two f-structure analyses. The parser produces packed f-structure solutions where two possible f-structures are indicated, as in Figure 10.20.

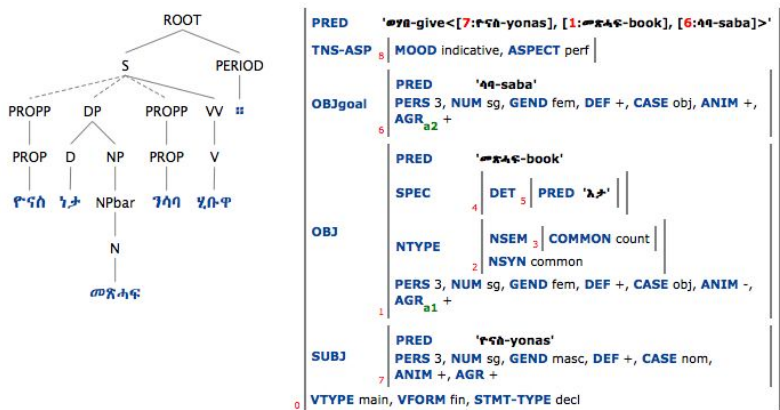

Figure 10.20: Agreement with OBJgoal and OBJ

The indices a1 and a2 indicate the constraints that differentiate the two f-structure solutions. Hence, in solution 1 OBJ (index a1) will have the attribute-value pair AGR +, and in solution 2 OBJgoal (index a2) will have it.

In Tigrinya either of the object arguments of ditransitive predicates can be expressed as the subject in a passive clause. In addition, the passive predicate can also bear a suffix to index an object when it has a definite referent. The c-structure and f-structure analyses in Figure 10.21 show the analysis of a passive with the theme argument realized as the SUBJ.

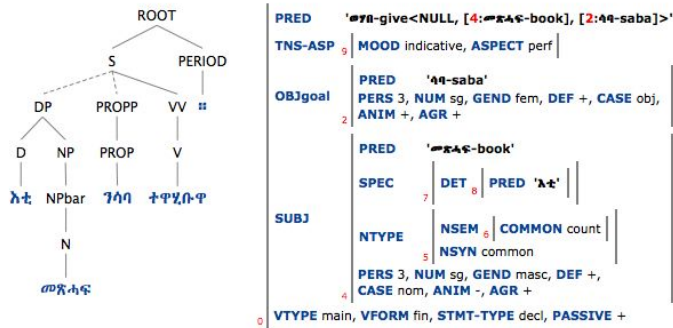

Figure 10.21: Ditransitive passive with theme SUBJ

In the PRED representation of a passive predicate, the first argument, i.e. the agent, is suppressed, which is signaled by the NULL label. The second argument, which is the theme, is realized as the subject, and the recipient argument is realized as OBJgoal. OBJgoal is cross-referenced on the verb, as is indicated by the AGR + in the OBJgoal f-structure. It should be noted that in the ditransitive passive clause, when the theme argument is mapped to the subject, the recipient is consistently analyzed as λt the OBJgoal. In this analysis it is assumed that the theme argument is the prototypical OBJ. In Figure 10.22, since the recipient is realized as the SUBJ, the theme is analyzed as the OBJ.

The PRED representation codes a suppressed agent argument (NULL), a theme argument which corresponds with the OBJ, and a recipient which is associated with the SUBJ. The f-structure that is associated with the OBJ does not contain the AGR + since the OBJ is indefinite.

In the ditransitive clause the OBJgoal is associated with arguments that display patient-like properties such as the ability to be expressed as a subject in passive clauses and to be indexed with the pronominal suffix like the theme objects that co-occur with it. Since the OBJgoal function is underspecified for the semantic

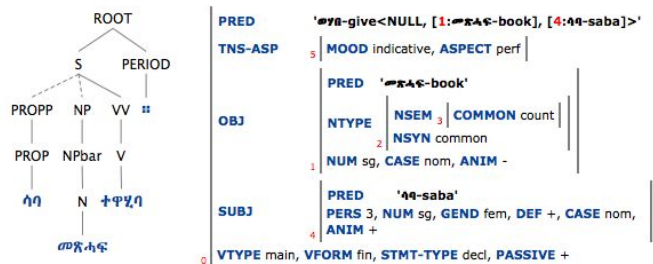

Figure 10.22: recipient expressed as SUBJ

roles it expresses, the subscript 'goal' is not meant to indicate semantic restriction as is the convention in LFG. We assign this function to object arguments other than the theme that reflect genuine patient-like properties. OBJgoal co-occurs with the OBJ in ditransitive predicates such as **ሃበ** *habä* 'he gave' and **ዓደለ** *ʿaddälä* 'he distributed', **መሃረ** *māharä* 'he taught' and **ነገረ** *nägärä* 'he told', **ሰረቆ** *säräqä* 'he stole', **ጸገገ** *ṣäʿanä* 'he loaded', **ቀደሐ** *qädhä* 'he extracted/drew', etc. (refer to Table 5.1 for the classification of verbs).

Even though OBJ and OBJgoal are regarded as symmetrical with respect to the primary objecthood properties discussed in chapter 8.3, there are other coding differences such as obligatory case marking that distinguish OBJgoal from OBJ (see chapter 8.3.1), such as the word order freezing constraint which distinguishes them when both objects bear the objective case. The grammar employs word order, case marking and pronominal indexation constraints to achieve the correct analysis of these apparently symmetrical objects. Where ambiguities exist, the parser outputs ambiguous solutions, as was illustrated in Figure 10.20.

10.6.2 Analysis of applied objects in transitive clauses

As was discussed in chapter 8.2.1 and 8.3.2, an object that can be associated with semantic roles such as beneficiary, maleficiary, locative, instrumental or source, among others, reflects different properties than the base object of a monotransitive clause and the recipient object of a ditransitive clause. In the grammar, objects that are associated with these semantic roles are given the category label OBJappl. OBJappl is underspecified for the semantic roles with which it is associated. OBJappl bears the same objective case as the OBJgoal and the definite OBJ. Applied objects that assume these semantic roles are obligatorily indexed on the verb through the pronominal suffix OM₂. However, when the transitive predicate

bears OM_1 , the applied roles are expressed by a prepositional phrase. In this clause a beneficiary argument is associated with the OBL function. In the default word order OBJappl precedes OBJ as in the ditransitive clause. In most cases, these objects can switch order or can be fronted before the subject in order to effect various information structure readings, although certain applied arguments are constrained to appear in fixed order when the theme object is definite. An applied object with a beneficiary/maleficiary semantic role reading can switch order even when it co-occurs with a definite theme object; however, an applied object that assume other roles (e.g. locative and instrumental) must precede a definite theme object. In (367) we modify the c-structure rule given in (348) in order to account for the OBJappl.

(367) Annotation of OBJappl

S	-->	NOM*:	{ (^ SUBJ)=!	“SUBJ annotation”
				(! CASE)=nom
			(^ OBJ)=!	“OBJ annotation”
				{ { ~(! DEF)=c+
				~(^ SUBJ DEF)=+
				~(^ OBJ)<h (^ SUBJ)}
				(!CASE)=nom
				(! CASE)=c obj
				(! DEF)=c +
				{ (^ OBJappl) “stipulates presence of OBJappl”
				{ ~(! DEF)= +
				(! DEF)=c +
				{ ~(^ OBJappl SEM-role)=ben
				~(^ OBJ)<h (^ OBJappl)
				(^ OBJappl SEM-role)=c ben } }
				{ ~(^ OBJgoal DEF)=c + “constraints on OBJgoal”
				{ (^ AGR)=c +
				(^ OBJgoal AGR)=c + } }
				~(^ OBJgoal) <h (^ OBJ)}
			(^ OBJgoal)	“OBJgoal annotation”
				(! CASE)=c obj
			(^ OBJappl)=!	“OBJappl annotation”
				(! CASE)=c obj
				(! AGR)=c +
				~(^ OBJgoal)<h (^ OBJappl)},
V:			^=!	.

There are two constraining equations that are associated with the annotation for OBJappl. The first one, (! CASE)=c obj, requires OBJappl to appear marked with obj case, and the second one, (! AGR)=c +, requires OBJappl to obligatorily cross-reference with object verbal suffixes. OBJappl obligatorily precedes OBJgoal when the two objects co-occur in the same clause, and thus the annotation $\sim(^OBJgoal)<h(^OBJappl)$ prevents them from switching order. The c-structure

rule also includes word order constraints that prevent a definite OBJ from preceding an OBJappl (“OBJ annotation”). We extract the word order constraints that apply to OBJ vs OBJappl from the rule in (367) for the sake of illustration in (368).

(368)

```
{ (^ OBJappl) “stipulates presence of OBJappl”
{ ~(! DEF)= + “disjunct 1”
|(! DEF)=c + “disjunct 2”
{ ~(^ OBJappl SEM-role)=ben
~(^ OBJ)<h (^ OBJappl)
| (^ OBJappl SEM-role)=c ben }}
```

The annotation (^ OBJappl) requires the presence of an OBJappl, and conditions on the co-occurrence of OBJappl and OBJ are stated. In the context where the OBJ is indefinite, indicated through ~(! DEF)= +, no word order constraint is involved (“disjunct 1”). However, when the OBJ is definite and the applied object argument is not a beneficiary, OBJ must not precede OBJappl, as expressed by the second disjunct (“disjunct 2”). The semantic role reading of an OBJappl usually depends on the semantics of the base verb. Thus, verb entries are annotated with information about the semantic reading of OBJappl that they may express. For example, verbs that allow a beneficiary reading are annotated with (^ OBJappl SEM)=ben, and such annotations are employed in order to express constraints that concern applied objects. For example, the suffix *-la*, which is the OM₂ suffix form, attached to the predicate **ገዘኩላ** *gäziʔ-u-la* “He bought (for/from) her something” can express either a beneficiary or a source semantic role reading, as illustrated by the lexical entries in (369).

(369) Lexicon entry for applied verbs with transitive base

```
ገዘኩላ V * @(V-TRANS-OBJappl ገዘኩ-buy)
@U @LA
@PERFECT-GERUND
(^ VFORM)=fin (^ VTYPE)=main
{(^ OBJappl SEM-role)= ben|(^ OBJappl SEM-role)=source}.
ገዘኩሉ V * @(V-TRANS-OBJappl ገዘኩ-buy)
@U @LU
@PERFECT-GERUND
(^ VFORM)=fin (^ VTYPE)=main
{(^ OBJappl SEM-role)= ben|(^ OBJappl SEM-role)=source}.
```

The template @(V-TRANS-OBJappl **ገዘኩ**-buy) refers to the subcategorization frame of applied verbs derived from transitive bases which is defined in the template

section of the grammar, as shown in (370).

(370) Transitive predicate subcategorized for OBJappl

$$\begin{aligned} \text{V-TRANS-OBJappl (P)} &= (\text{^ PRED})=\text{'P}<(\text{^ SUBJ}) (\text{^ OBJ}) (\text{^ OBJappl})>' \\ &\quad \{ (\text{^ SUBJ PRED})=\text{'pro'} \} \\ &\quad \{ (\text{^ OBJ PRED})=\text{'pro'} \} \\ &\quad \{ (\text{^ OBJappl PRED})=\text{'pro'} \} \end{aligned}$$

The templates @LA and @LU refer to the agreement information of a third person feminine singular OBJappl and a third person masculine singular OBJappl, respectively. The agreement information represented by these templates is given in (371).

(371) OM₂ applicative suffix

$$\begin{aligned} \text{LA} &= \{ (\text{^ OBJappl GEND})=\text{fem} \\ &\quad (\text{^ OBJappl NUM})=\text{sg} \\ &\quad (\text{^ OBJappl PERS})=3 \\ &\quad (\text{^ OBJappl AGR})=+ \\ &\quad \{ (\text{^ OBJappl PRED FN})=\text{c pro} \\ &\quad | \sim (\text{^ OBJappl PRED FN})=\text{c pro} \\ &\quad (\text{^ OBJappl CASE})=\text{c obj} \\ &\quad (\text{^ OBJappl DEF})=\text{c +} \} \\ \text{LU} &= \{ (\text{^ OBJappl GEND})=\text{masc} \\ &\quad (\text{^ OBJappl NUM})=\text{sg} \\ &\quad (\text{^ OBJappl PERS})=3 \\ &\quad (\text{^ OBJappl AGR})=+ \\ &\quad \{ (\text{^ OBJappl PRED FN})=\text{c pro} \\ &\quad | \sim (\text{^ OBJappl PRED FN})=\text{c pro} \\ &\quad (\text{^ OBJappl CASE})=\text{c obj} \\ &\quad (\text{^ OBJappl DEF})=\text{c +} \} \end{aligned}$$

The syntactic rule (367), lexical entries (369) and template specifications (370) and (371) will enable us to parse the applicative clauses in example (372), which codes the default order of OBJappl and OBJ. This analysis is shown in Figure 10.23.

(372) የሩስ ነታ ንል መጽሐፍ ገዘኩላ ።
 Yonas n-ät-a g^wal mäṣṣḥaf gäzi-u-la
 Yonas.M Obj-Det-3FSg girl book.Sg PerfS.buy-SM.3MSg-OM₂.3FSg
 ‘Yonas bought the girl.F a book.’

The c-structure on the left shows the default order, whereas the one on the right shows the reverse order of OBJappl and OBJ. The OBJappl is ambiguous between the beneficiary and the source reading. Therefore, the SEM-role feature can have two possible values, one with a beneficiary reading (a1) and another with a source reading (a2), as in Figure 10.24.

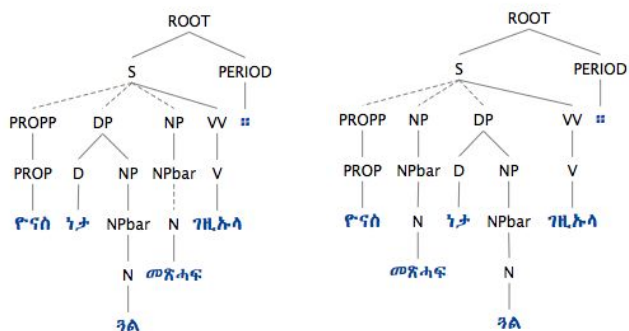

Figure 10.23: Word order of indefinite OBJ and OBJappl

PRED	'ገሥት-buy<[10:ጥናሱ-yonas], [1:መጽሐፍ-book], [4:ገሥት-girl]>'																																						
TNS-ASP	11 MOOD indicative, ASPECT perf																																						
	<table border="1"> <tr> <td>PRED</td> <td>'ገሥት-girl'</td> </tr> <tr> <td>SPEC</td> <td>8 DET 9 PRED 'ገሥት' </td> </tr> <tr> <td>OBJappl</td> <td>7 SEM-role (a1 ben, a2 source) </td> </tr> <tr> <td></td> <td> <table border="1"> <tr> <td>NTYPE</td> <td>NSEM 6 COMMON count </td> </tr> <tr> <td></td> <td>NSYN common </td> </tr> </table> </td> </tr> <tr> <td></td> <td>5 PERS 3, NUM sg, GEND fem, DEF +, CASE obj, ANIM +, AGR + </td> </tr> <tr> <td></td> <td>4 </td> </tr> <tr> <td></td> <td> <table border="1"> <tr> <td>PRED</td> <td>'መጽሐፍ-book'</td> </tr> <tr> <td>NTYPE</td> <td>NSEM 3 COMMON count </td> </tr> <tr> <td></td> <td>2 NSYN common </td> </tr> <tr> <td></td> <td>1 NUM sg, CASE nom, ANIM - </td> </tr> </table> </td> </tr> <tr> <td>OBJ</td> <td></td> </tr> <tr> <td></td> <td> <table border="1"> <tr> <td>PRED</td> <td>'ጥናሱ-yonas'</td> </tr> <tr> <td>SUBJ</td> <td>PERS 3, NUM sg, GEND masc, DEF +, CASE nom, ANIM +, AGR + </td> </tr> <tr> <td></td> <td>10 </td> </tr> </table> </td> </tr> <tr> <td></td> <td>0 VTYPE main, VFORM fin, STMT-TYPE decl </td> </tr> </table>	PRED	'ገሥት-girl'	SPEC	8 DET 9 PRED 'ገሥት'	OBJappl	7 SEM-role (a1 ben, a2 source)		<table border="1"> <tr> <td>NTYPE</td> <td>NSEM 6 COMMON count </td> </tr> <tr> <td></td> <td>NSYN common </td> </tr> </table>	NTYPE	NSEM 6 COMMON count		NSYN common		5 PERS 3, NUM sg, GEND fem, DEF +, CASE obj, ANIM +, AGR +		4		<table border="1"> <tr> <td>PRED</td> <td>'መጽሐፍ-book'</td> </tr> <tr> <td>NTYPE</td> <td>NSEM 3 COMMON count </td> </tr> <tr> <td></td> <td>2 NSYN common </td> </tr> <tr> <td></td> <td>1 NUM sg, CASE nom, ANIM - </td> </tr> </table>	PRED	'መጽሐፍ-book'	NTYPE	NSEM 3 COMMON count		2 NSYN common		1 NUM sg, CASE nom, ANIM -	OBJ			<table border="1"> <tr> <td>PRED</td> <td>'ጥናሱ-yonas'</td> </tr> <tr> <td>SUBJ</td> <td>PERS 3, NUM sg, GEND masc, DEF +, CASE nom, ANIM +, AGR + </td> </tr> <tr> <td></td> <td>10 </td> </tr> </table>	PRED	'ጥናሱ-yonas'	SUBJ	PERS 3, NUM sg, GEND masc, DEF +, CASE nom, ANIM +, AGR +		10		0 VTYPE main, VFORM fin, STMT-TYPE decl
PRED	'ገሥት-girl'																																						
SPEC	8 DET 9 PRED 'ገሥት'																																						
OBJappl	7 SEM-role (a1 ben, a2 source)																																						
	<table border="1"> <tr> <td>NTYPE</td> <td>NSEM 6 COMMON count </td> </tr> <tr> <td></td> <td>NSYN common </td> </tr> </table>	NTYPE	NSEM 6 COMMON count		NSYN common																																		
NTYPE	NSEM 6 COMMON count																																						
	NSYN common																																						
	5 PERS 3, NUM sg, GEND fem, DEF +, CASE obj, ANIM +, AGR +																																						
	4																																						
	<table border="1"> <tr> <td>PRED</td> <td>'መጽሐፍ-book'</td> </tr> <tr> <td>NTYPE</td> <td>NSEM 3 COMMON count </td> </tr> <tr> <td></td> <td>2 NSYN common </td> </tr> <tr> <td></td> <td>1 NUM sg, CASE nom, ANIM - </td> </tr> </table>	PRED	'መጽሐፍ-book'	NTYPE	NSEM 3 COMMON count		2 NSYN common		1 NUM sg, CASE nom, ANIM -																														
PRED	'መጽሐፍ-book'																																						
NTYPE	NSEM 3 COMMON count																																						
	2 NSYN common																																						
	1 NUM sg, CASE nom, ANIM -																																						
OBJ																																							
	<table border="1"> <tr> <td>PRED</td> <td>'ጥናሱ-yonas'</td> </tr> <tr> <td>SUBJ</td> <td>PERS 3, NUM sg, GEND masc, DEF +, CASE nom, ANIM +, AGR + </td> </tr> <tr> <td></td> <td>10 </td> </tr> </table>	PRED	'ጥናሱ-yonas'	SUBJ	PERS 3, NUM sg, GEND masc, DEF +, CASE nom, ANIM +, AGR +		10																																
PRED	'ጥናሱ-yonas'																																						
SUBJ	PERS 3, NUM sg, GEND masc, DEF +, CASE nom, ANIM +, AGR +																																						
	10																																						
	0 VTYPE main, VFORM fin, STMT-TYPE decl																																						

Figure 10.24: A source semantic role reading of OBJappl

When the verb indexes a definite theme object, the beneficiary argument assumes an OBL function. As noted in chapter 8.3.1 the preposition *ni-* is a polysemous marker. It functions as a marker of a direct case when it marks definite theme objects and applied objects, whereas it functions as a prepositional marker when it codes beneficiary arguments that are not indexed through verbal suffixes. The c-structure and f-structure in Figure 10.25 show the OBL analysis of the beneficiary argument (373).

(373) የኖስ ነቲ መጽሓፍ ንሳባ ገዘኡዎ ።
 Yonas n-ät-i mäṣḥaf ni-Saba gäzi-u-wo
 Yonas.M Obj-Det-3MSg book.Sg Dir-Saba PerfS.buy-SM.3MSg-OM₁.3MSg
 ‘Yonas bought the book for Saba.’

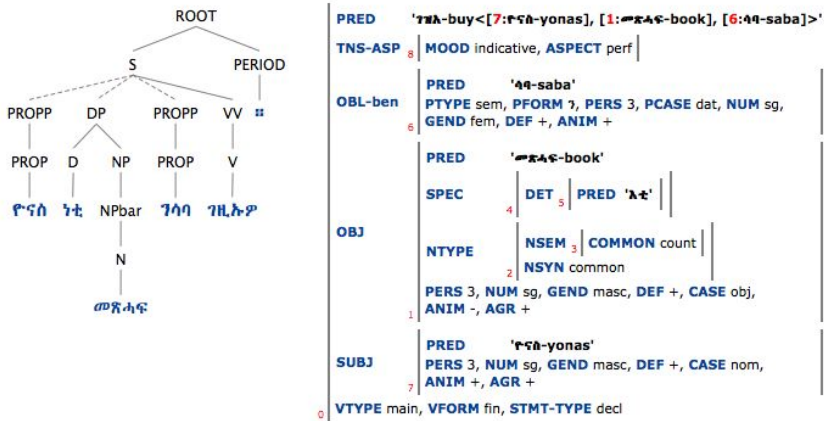

Figure 10.25: Beneficiary OBL expression

In Tigrinya when a preposition is composed of a single syllable, such as *ni-* or *bi-*, it directly adjoins to the NPs or the DPs which are the complements of the prepositions (refer to chapter 6.3). The nominals to which the preposition attaches will still be, NP or DP category, analyzed as an obliquely marked nominal. The lexical entries of nouns and determiners that are directly marked with *ni-* bear alternative annotations which express that the marker can function either as an objective case, (^CASE)=obj, or as an oblique case, (^PCASE)=dat. The ‘obj’ case is used when the marked object is also pronominally indexed on the verb, and the ‘dat’ will be used when the marked object is not cross-referenced on the verbs, and thus has an OBL function. A similar analysis is proposed by Spencer (2005) for postpositions adjoined to NPs or DPs in Hindi.

OBJappl obligatorily precedes a definite OBJ when it expresses a semantic role other than the beneficiary, for example, a source, a locative or an instrumental, and in this pattern, the OBJappl is obligatorily indexed on the verb (374). The analysis of this type of applied objects looks like the one given in Figure 10.26.

- (374) የኖስ ነቲ ሰደቻ ነቲ መጽሐፍ
 Yonas n-ät-i sädäqä n-ät-i mäšihaf
 Yonas.M Obj-Det-3MSg desk.Sg Obj-Det-3MSg book.Sg
 አንቢሩ ።
 ?anbir-u-lu
 PerfS.put/place-SM.3MSg-OM₂.3MSg
 ‘Yonas put the book on the desk.’

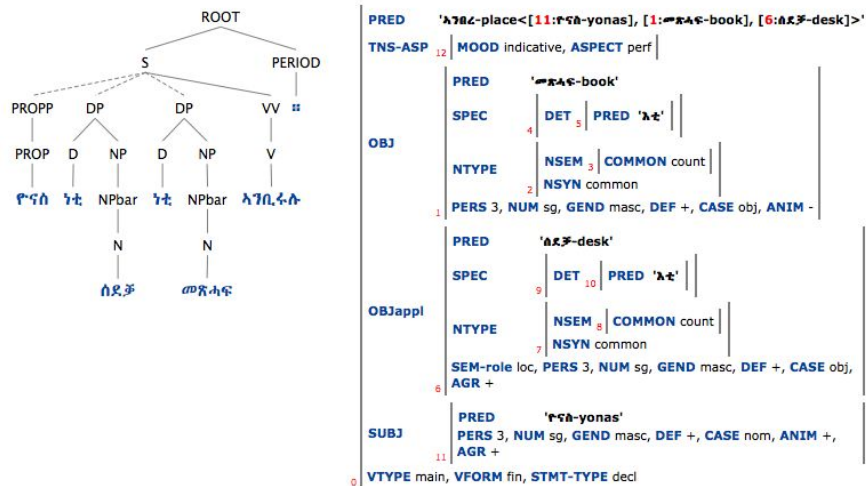

Figure 10.26: OBJappl co-occurring with definite OBJ

As with the beneficiary argument, locative, instrumental and source arguments are coded as OBLs when the verb indexes the theme object. The analysis of an obliquely expressed locative argument that co-occurs with a pronominally indexed OBJ (375) is shown in Figure 10.27.

- (375) የኖስ ነቲ መጽሐፍ አብ ሰደቻ
 Yonas n-ät-i mäšihaf ?ab sädäqä
 Yonas.M Obj-Det-3MSg book.Sg Loc.on desk.Sg
 አንቢሩ ።
 ?anbir-u-wo
 PerfS.put-SM.3MSg-OM₁.3MSg
 ‘Yonas put the book on the desk.’

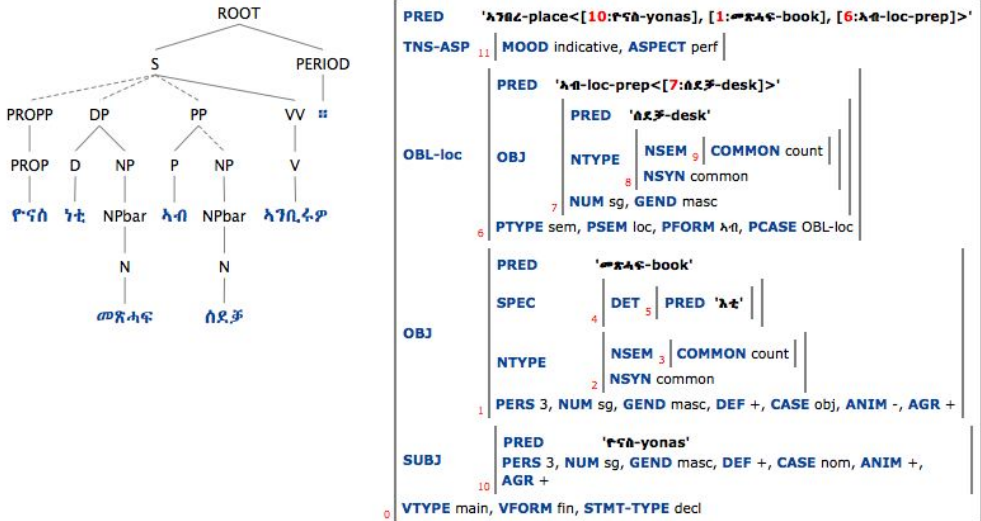

Figure 10.27: OBL expression of a locative argument

The locative preposition ኣብ *ʔab* is realized as an independent preposition, unlike the directional *ni-* and the instrumental *bi-*. In the c-structure the independent locative preposition is the head of the PP and takes the NP as its complement. In the f-structure the PP is assigned an OBL function whose semantic relation is specified by a preposition, which in this example is a locative preposition.

As we noted in chapters 4.4.5 and 8.3.3, some transitive verbs, for example, *ወሲዱዎ/ሉ* *wäsidu-wo/lu* ‘he took it/he took a portion of it (from it)’, *በሊዑዎ/ሉ* *bäliʕu-wo/lu* ‘he ate it/he ate a portion of it (from it)’ and *ሰቲዩዎ/ሉ* *sätiyu-wo/lu* ‘he drank it/he drank a portion of it (from it)’, allow either of the object pronominal suffixes – *OM*₁ to code a completely affected object, and *OM*₂ to code a partially affected object. In these instances, the object coded with *OM*₁ is analyzed as OBJ, and the object coded with *OM*₂ is analyzed as OBJappl (376). The c-structure and f-structure representation of the partially affected OBJappl reading is given in Figure 10.28.

- (376) ጥናስ ነቲ ቅጭ በሊዑላ ።
 Yonas n-ät-a qiça bäliʕ-u-la
 Yonas.M Obj-Det-3FSg bread PerfS.eat-SM.3MSg-OM₂.3FSg
 ‘Yonas ate from the bread.’ (He ate a portion of the bread.)

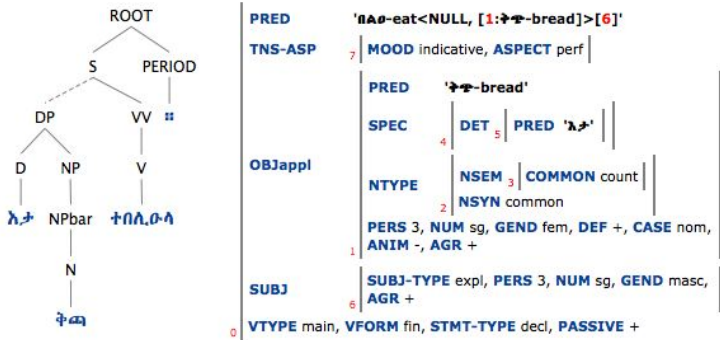

Figure 10.29: Analysis of partitive OBJappl in passive clause

(378) Expletive subjects of applied passive predicates

$$\begin{aligned}
 \text{V-TRANS-OBJappl (P)} &= \{ (\wedge \text{PRED}) = \text{'P} < (\wedge \text{SUBJ}) (\wedge \text{OBJ}) (\wedge \text{OBJappl}) > \} \\
 &\quad \{ (\wedge \text{SUBJ PRED}) = \text{'pro'} \} \\
 &\quad \{ (\wedge \text{OBJ PRED}) = \text{'pro'} \} \\
 &\quad \{ (\wedge \text{OBJappl PRED}) = \text{'pro'} \} \\
 &\quad | \\
 &\quad (\wedge \text{PRED}) = \text{'P} < \text{NULL} (\wedge \text{OBJappl}) > (\wedge \text{SUBJ}) \text{' } \\
 &\quad (\wedge \text{PASSIVE}) = \text{c} + \\
 &\quad \sim (\wedge \text{SUBJ PRED FN}) \\
 &\quad (\wedge \text{SUBJ SUBJ-TYPE}) = \text{expl} \\
 &\quad \{ (\wedge \text{OBJappl PRED}) = \text{'pro'} \}
 \end{aligned}$$

The first part of the disjunct is an argument structure for transitive applied predicates, and the second part of the disjunct is an argument structure for passive predicates with expletive subjects. The constraint $\sim (\wedge \text{SUBJ PRED FN})$ will prevent an overt nominal from becoming the semantic head of an expletive subject (i.e. to disallow it to associate with overt nominal expressions). In addition, the $(\wedge \text{SUBJ SUBJ-TYPE}) = \text{expl}$ feature identifies an expletive subject, and it is used to express constraints in syntactic structures that implicate it. For example, it is required in head precedence rules such as $(\wedge \text{OBJappl}) > \text{h} (\wedge \text{SUBJ})$ from which expletive subjects are exempted.

In the normal situation where there are distinct theme and applied arguments in the applicative clause, the passive predicate codes the theme argument as a subject, and the applied argument as an applied object. An ordinary applicative passive clause (379), will get c-structure and f-structure analyses similar to the ones shown in Figure 10.30.

ciary, an argument understood as psychologically affected by the event described by the verb, but not an argument undergoing physical adversities. On the other hand, with intransitive verbs such as ወዲቸዋ *wädiq̄u-wa* ‘it fell on her’ and ኣትዩዋ *?aty-u-wa* ‘it went in/into her’ /‘it pierced her’ the applied object argument is interpreted as being directly affected. In *wädiq̄u-wa* it can be understood as being psychological affected when the entity coded as the subject does not directly fall on the referent of the applied argument’s body. For example, when a glass falls on the ground from the hands of the referent of the applied argument. Moreover, the referent of the applied argument can also be interpreted as being directly affected in a situation where the entity coded as a subject falls directly on the referent, causing physical harm or pain. In contrast, with ኣሚሙላ *hamim-u-la* ‘he got sick for her’ OM₂ can express a beneficiary or a time span (e.g the day/time he was sick), and with መዩተላ *mäyit-u-la* ‘he/it died for/on her/it.F’ it can express a beneficiary, a time-span or a location (e.g. the bed he died on).

In the grammar applied objects coded by intransitive base verbs through the suffix OM₂ are identified as OBJappl. Like the OBJappl subcategorized for by transitive predicates, OBJappls of intransitive predicates are underspecified for the semantic roles they can express. It ambiguously expresses a beneficiary, a locative, a source or an event time reading of the applied argument. In Figure 10.31 we provide a parse output for an applied clause with a locative OBJappl (380).

(380) ዮናስ ነታ ዓራት ደቂሱላ ።
 Yonas n-ät-a farat däq̄is-u-la
 Yonas.M Obj-Det-3FSg bed.Sg PerfS.sleep-SM.3MSg-OM₂.3FSg
 ‘Yonas slept on the bed.’

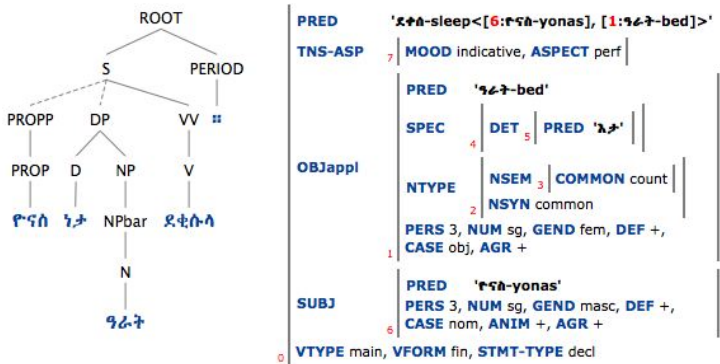

Figure 10.31: Analysis of OBJappl hosted by intransitive verb

In addition, an applied argument with a beneficiary, a locative, a source or a time span semantic reading cannot be coded as a subject of an applied passive predicate with an intransitive verb base (refer to chapter 2.4.4. With intransitive predicates that can allow the passive prefix, the subject pronominal suffix corresponds to an athematic argument, i.e. a null subject, and the object pronominal suffix corresponds to the applied argument, as in ተደቂሱላ *tä-däqis-u-la* ‘it has been slept on’ (the argument structure for applied passive predicates is modeled in chapter 8.4.3). Intransitive applied predicates are assigned an alternative subcategorization frame to handle the realization of the expletive subject, which is shown in (381).

(381)

$$\begin{aligned}
 \text{V-INTRANS-OBJappl (P)} &= (\text{ }^{\wedge} \text{ PRED})=\text{'P< NULL (}^{\wedge} \text{ OBJappl)> (}^{\wedge} \text{ SUBJ) ' } \\
 &(\text{ }^{\wedge} \text{ PASSIVE})=c + \\
 &\sim (\text{ }^{\wedge} \text{ SUBJ PRED FN}) \\
 &(\text{ }^{\wedge} \text{ SUBJ SUBJ-TYPE})=\text{expl} \\
 &\{ (\text{ }^{\wedge} \text{ OBJappl PRED})=\text{'pro' } \}
 \end{aligned}$$

The c-structure and f-structure analyses of an OBJappl in an intransitive passive clause (382) is shown in Figure 10.32.

(382) አታ ገራት ተደቂሱላ ።
 ?it-a farat tä-däqis-u-la
 Det-3FSg bed DT-PerfS.sleep-SM.3MSg-OM₂.3FSg
 ‘The bed was slept on.’

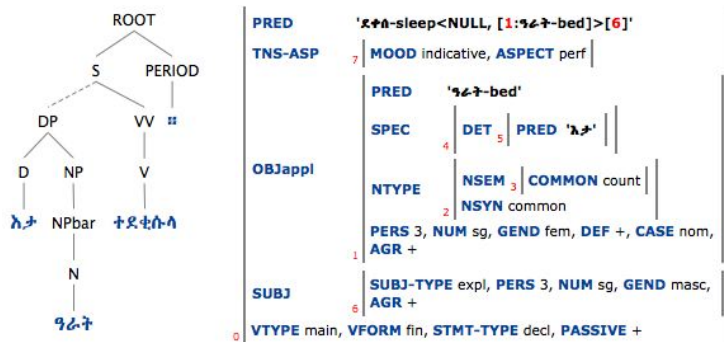

Figure 10.32: Expletive SUBJ in a passive applicative clause

Moreover, it should be noted that passive applicative predicates may not always be able to express all the applied object readings possible with their active counterparts. For example, ደቂሱላ *däqis-u-la* ‘He slept for/on her/it.’ can express a

beneficiary or a locative reading, while the passive form ተደቂቡሉ *tä-däqis-u-la* ‘it has been slept on it’ can only express a locative reading. The expression of a beneficiary appears to be incompatible with the semantics of the intransitive passive predicate.

The suffix OM₁ can express a maleficiary, an experiencer, a possessor or a goal applied object reading, depending on the lexical semantics of the intransitive verb that allows this suffix. Applied arguments that cannot be associated with a subject in a passive applied predicate are analyzed as object functions that bear labels that signal their semantic restrictedness such as OBJmal, OBJexper and OBJposs, whereas those that can be associated with a subject are analyzed as OBJgoal. OBJmal, OBJexper and OBJposs reflect behavior similar to that of OBJappl with respect to passivization, but they denote a higher degree of affectedness than OBJappl. For example, the argument of OBJmal is perceived to be adversely affected, the argument of OBJexper is perceived to be psychologically affected, and the argument of OBJposs is perceived to be spatially affected by containing the referent of the possessee argument. The analysis of an intransitive applicative clause that codes an OBJmal (383) is given in Figure 10.33.

(383) የኅሰ መጽሐፍ ጠፊኡዎ ።
 Yonas mäsiḥaf täfi?-u-wo
 Yonas.M book PerfS.disappear-SM.3MSg-OM₁.3MSg
 ‘A book disappeared on Yonas.’

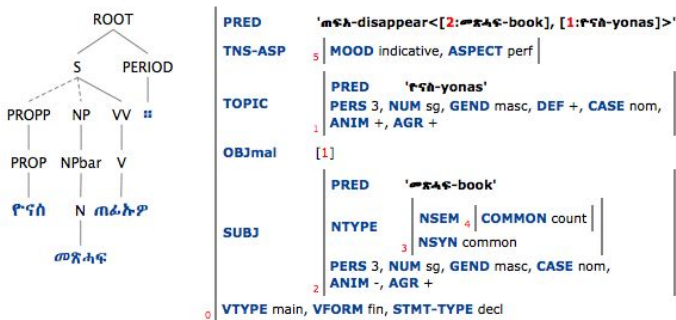

Figure 10.33: OBJmal in an intransitive passive clause

The applied objects of such intransitive verbs tend to appear clause initially, and in this position, the objective case becomes optional. Applied objects that are more topical than subjects reflect this kind of coding pattern, and so they assume the primary topic function in such structures. The meaning of the predicate ጠፊኡዎ

täfi?-u ‘it got lost’ is incompatible with passivization, and thus it does not allow the passive prefix. Therefore *ተጠፊኡዎ/ሉ tä-tä fi?-u-wo/lu is an ill-formed passive predicate in Tigrinya.

As with OBJmal, OBJexper is analyzed as a restricted object. OBJexper corresponds to arguments that are perceived to undergo psychological or emotional adversities (refer to chapter 4.4.6 for more information). OBJexper is subcategorized by psych verbs that employ a subject suffix which indexes an athematic subject. The semantic vacuity of the subject is expressed by representing it outside the subcategorization frame of the predicate. In this structure, the OBJexper is also discourse topical in the clause. As a result, it can optionally be marked by the objective case as we saw with OBJmal. The analysis of an applicative clause with OBJexper (384) is given in Figure 10.34.

- (384) ሳባ ጸምዖዋ ።
 Saba şämy-u-wa
 Saba.F PerfS.be=quiet-SM.3MSg-OM₁.3FSg
 ‘Saba is lonely. /Lit: It became quiet for Saba.’

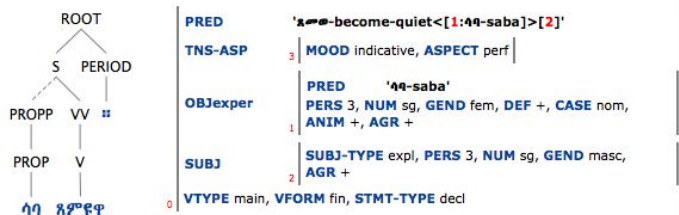

Figure 10.34: Analysis of the applicative OBJexper

In the f-structure, only the OBJexper appears inside the angled brackets which code semantic argument positions within the PRED representation, whereas the SUBJ appears outside the representation of semantic arguments within the PRED. Active predicates with athematic subjects are also incompatible with passivization. Therefore, attaching the passive prefix to such predicates results in an ill-formed passive form, as in *ተጸምዖዋ tä-şämy-u-wa.

Another object that shows a syntactic structure similar to the OBJmal is the possessor applied object. The possessor applied object reading is derived from the copula ኣሎ ?all-o ‘it exists’ /‘it is’, which is also used in locative and existential constructions. In possessive constructions the copula is obligatorily marked by the affected object pronominal suffix OM₁, as in ኣሎዋ ?all-o-wa ‘it exists in/on her’

/' there is in/on her', which co-references with a possessor applied object. In addition, the subject suffix corresponds to a possessee argument (see chapters 4.4.7 and 6.4.2). Following the analyses proposed by Bresnan (1994, 2001) for locative inversion, and Falk (2007) for Hebrew possessive copula constructions, we assume that complements of the locative copula are not predicative complements (XCOMPs), but arguments that can be associated either with an OBL or an OBJposs. Since possessive expressions have syntactic structure similar to that of applicatively coded locative arguments, they are analyzed as applicative constructions. This view is confirmed by the structure of an abstract possessor expressed as an applied object (385b), which can otherwise also be coded as a complement of a preposition (385a).

- (385) a. እቲ መጽሓፍ ኣብ ጥዑላ ኣሎ ።
 ?it-i məšħaf ?ab ʔawla ?all-o
 Det-3MSg book.Sg loc.on table.Sg Pres.loc=be-SM.3MSg
 'The book is/exists on the table.'
- b. እታ ጥዑላ መጽሓፍ ኣሎዋ ።
 ?it-a ʔawla məšħaf ?all-o-wa
 Det-3FSg table.Sg book.Sg Pres.loc=be-SM.3MSg-OM₁.3FSg
 'The table has a book on it./There is a book on the table.'

When the locative complement is expressed in a prepositional phrase, the locative copula cannot bear the suffix OM₁ to index it (385a). In this structure, the copula can only agree with the subject. The analysis of this clause is shown in Figure 10.35.

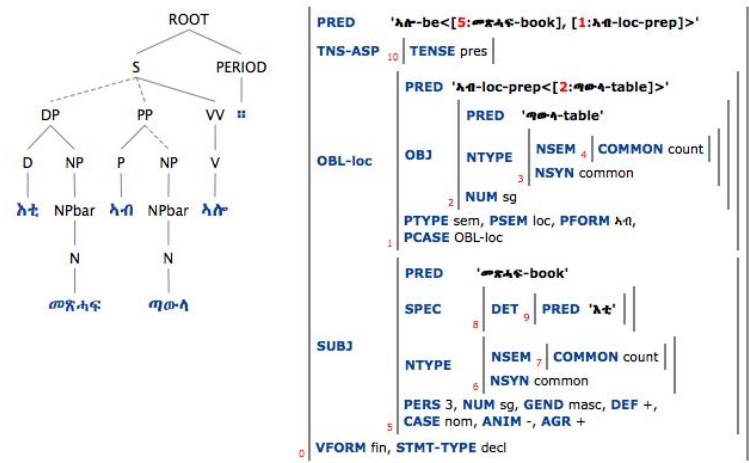

Figure 10.35: Locative OBL

When the locative argument is more topical in the discourse, it is expressed in an applicative clause (385b). In this clause the locative applied object is indexed on the copula verb through the OM₁. The locative argument in this applicative clause is perceived as an abstract possessor since its referent has spatial semantics. The analysis with the applicative expression of the locative argument is given in Figure 10.36.

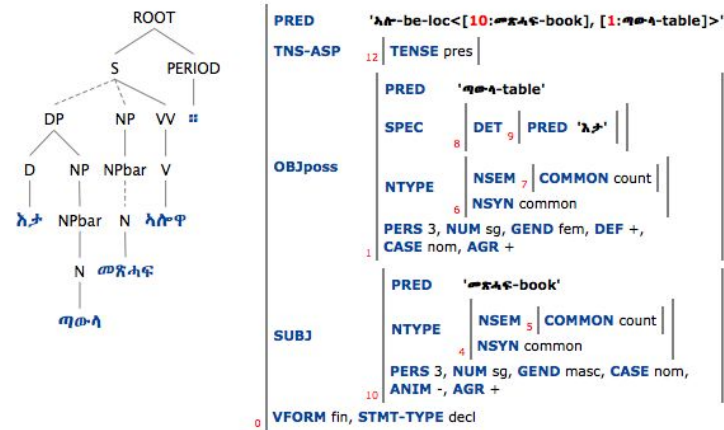

Figure 10.36: OBJposs with inanimate possessor

When the complement of the locative applied copula is an animate entity or a human, the applied object has a genuine possessive reading. This indicates that it is the semantic properties of the referent that yields the different readings of the applied objects, rather than their morphosyntactic structure. The possessive applicative clause with a human possessor argument (386) has the same syntactic structure as in (10.36). Consequently, it is given the same syntactic and functional analysis, as Figure 10.37 shows.

- (386) ሳባ አሕዎት አሎዉዎ ።
 Saba ?ahwat ?allo-wu-wa
 Saba.F sibling.PI Pres-exist-SM.3MPI-OM₁.3FSg
 ‘Saba has siblings. /Lit: Siblings exist for Saba.’

In the possessive construction, normally the object precedes the subject. Since the possessor is more topical than the possessee, the OBJposs appears in clause initial position and bears an optional objective case. Like the other intransitive predicates with adversely or psychologically affected arguments, the possessive predicate does not have a passive counterpart.

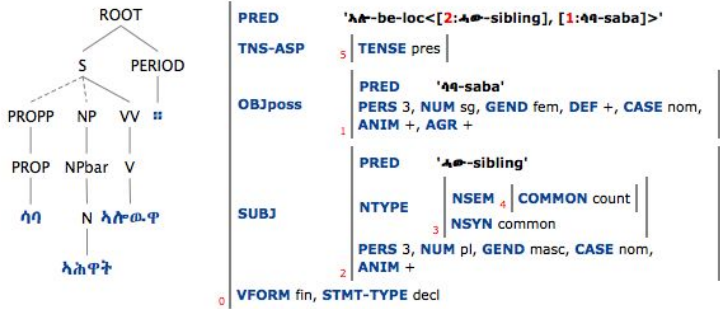

Figure 10.37: OBJposs with human possessor

With some unergative applicative predicates the applied argument displays genuine patient-like properties (refer to chapter 8.4.3. Unergative verbs that denote some sort of transferable actions, gestures or sounds performed or produced by agent-like arguments. The applied arguments coded with OM₁ undergo the events caused by the agent-like arguments. Unergative predicates such as **ሰሱቑዎ** *si hiq̄-u-wa* ‘he laughed at her’, **ጎዩዎ** *goyiy-u-wa* ‘he ran after her’/ ‘he chased her’, **መጸኡዎ** *mäsī?-u-wa* ‘he came to her’, **በጸሐዎ** *bäsih-u-wa* ‘he arrived at her/ he visited her’ and **ከዩዎ** *kä(yä)d-u-wa/la* ‘he went to her’ code applied arguments that denote a goal semantic role. As with the recipient and goal arguments of ditransitive predicates, the applied arguments that display genuine patient-like properties are associated with the OBJgoal. The applied arguments of such unergative predicates can be associated with the subject of a passive predicate. Figure 10.38 (page 387) shows the c-structure and f-structure analysis of an unergative applicative clause (387).

- (387) **እቲ ከልቢ ንሰባ ጎዩዎ ።**
 ?it-i kälbi ni-Saba g^wäy-u-wa
 Det-3MSg dog Obj-Saba PerfS.run-SM.3MSg-OM₁.3FSg
 ‘The dog ran after Saba./The dog chased Saba.’

The subject and object of unergative applicative clauses such as the ones given above are characterized by the same word order as the subject and the object of a monotransitive clause. In the default order the subject appears clause initially followed by the object. The applied argument can be expressed as a subject in a passive clause, and the initial agent argument can either remain unexpressed or can be coded as an OBL-agent (388). Figure 10.39 and Figure 10.40 show the two alternative analyses of this sentence.

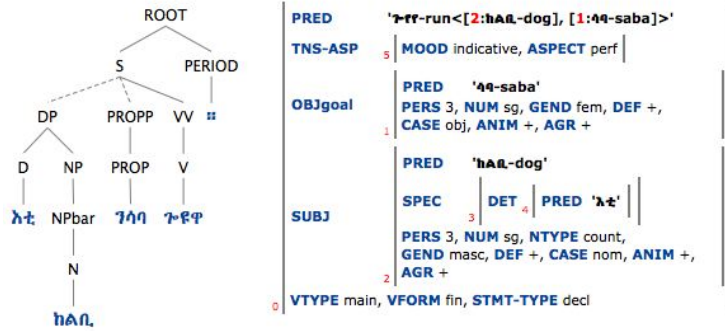

Figure 10.38: OBJgoal with unergative predicates

- (388) ላቲ (ከከልቢ) ገዳዋ ።
 Saba (bi-kälbi) t-ä-g^wäy-a
 Saba (Instr-dog) DT-PerfS.run-SM.3FSg
 ‘Saba was run after (by a dog)./Saba was chased (by a dog).’

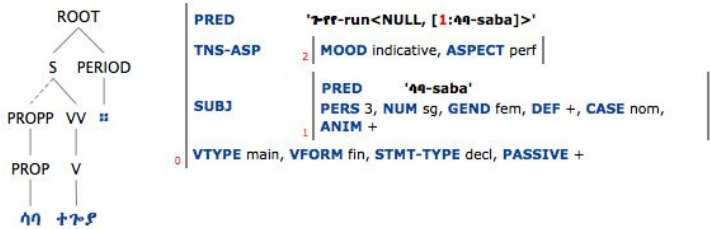

Figure 10.39: OBJgoal and NULL agent

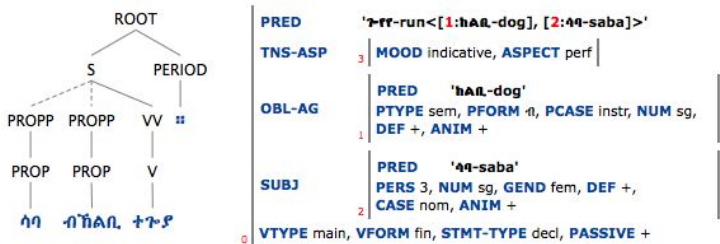

Figure 10.40: OBJgoal and OBL-AG

In Figure 10.39 the agent argument is NULL, and thus only the OBJgoal is overtly realized in the clause. In Figure 10.40 the agent is expressed in prepositional phrase marked by the instrumental preposition ከ bi- which is assigned an OBL-

AG function. The applied arguments of such unergative predicates behave like the primary object of a monotransitive clause.

10.7 Conclusion

In this chapter we presented the implementation of the Tigrinya grammar. In 10.2 we gave a brief overview of grammar development on the XLE platform. We presented the formats for writing phrase structure rules, lexical entries and templates. In 10.3 the implementation of various types of nominal phrases such as adjectival, adverbial, possessive, relative and determiner phrases was illustrated. In 10.4 the analysis of the simple clause was presented. We have shown how word order, case marking and pronominal suffix constraints are employed to license a well-formed construction in Tigrinya. Issues such as word order variation, word order freezing, marking of indefinite and definite objects (differential object marking) and pro-drop are accounted for by the grammar. In 10.5 we presented the passive lexical rule for Tigrinya, and we have illustrated the analysis of the passive.

Section 10.6 presented the analysis of double object and applicative constructions that involve different verb types. Furthermore, we illustrated the different mapping patterns found in passive forms of ditransitive verbs and applied transitive verbs. The analysis of double object constructions which involve ditransitive predicates was given in 10.6.1. These predicates are subcategorized for an OBJ and an OBJgoal, and the arguments of both objects display genuine patient-like properties. Either of them can be expressed as a subject in a passive predicate. In 10.6.2 we presented an analysis of transitive predicates which are subcategorized for an OBJ and an OBJappl. In these clauses only the OBJ shows genuine patient-like properties. We also demonstrated that the OBJappl can also express a partitive reading of the theme argument, which is then perceived as being a partially affected argument.

Finally, in 10.6.3 we presented an analysis of applied objects subcategorized for intransitive predicates. In these constructions applied objects can correspond to either OM_1 or OM_2 to express various readings of affectedness. Depending on the meaning of the intransitive base, the suffix OM_1 can correspond to either an OBJgoal, an OBJexper or a OBJposs, and each is perceived to code an affected argument. The argument of an OBJgoal reflects genuine patient-like properties because the initial arguments of the unergative predicates that are subcategorized for OBJgoals code agent-like properties. The passive forms of such unergative predicates express the goal argument as a subject. On the other hand, the argument

of an OBJexper is perceived as being psychologically affected, and the argument of an OBJposs is understood as being spatially affected, but since the initial arguments of these predicates do not reflect agent-like properties, the experiencer and possessor arguments are not treated as genuinely affected arguments in passivization, which means they cannot passivize. In addition, the suffix OM₂ codes an OBJappl in intransitive applied predicates, as it does with predicates of transitive bases. The argument of an OBJappl can have a beneficiary, a locative, a source or an instrumental reading. Such arguments do not reflect genuine patient-like properties. Consequently, they cannot be expressed as subjects of passivized intransitive predicates. The passive forms of these predicates employ a subject suffix for athematic or expletive subjects and the object suffix OM₂ for an OBJappl.

CHAPTER 11

Conclusions

This thesis investigates the applicative constructions of Tigrinya. Applicatives in this language have never been systematically described nor analyzed in any linguistic framework. We present a detailed description of the phenomenon. Furthermore, we analyze ditransitive and applicative constructions as problematic data for the theory of object asymmetries formulated as the feature decomposition model in LMT (Bresnan and Moshi 1990, Alsina and Mchombo 1993). Our findings confirm remarks that were made by Börjars and Vincent (2008) with respect to the properties of objects in English and the inadequacy of the feature method to capture object properties. The applicative clause involves an applied verb which is subcategorized for an object argument that normally is not among its lexically entailed core arguments, or is denoted as a peripheral/unimportant participant. Depending on the type of the verb hosting the applicative marker, the resulting predicate may code one, two or more objects. The theoretical motivation for LFG is to characterize the functional category of these objects. Hence in the present work we study the conditions that instigate object marking in Tigrinya, and analyze the semantic, functional and discourse properties of objects.

In the remainder of this conclusion chapter we will briefly discuss and summarize the conclusions reached in previous chapters. Chapters included in the preliminary Part I, chapter 1 ‘Introduction’, chapter 2 ‘The grammatical profile of Tigrinya’, and chapter 3 ‘LFG basic’, will not be included in this conclusion. We will focus on Part II, III and IV which contain the chapters that discuss the applica-

tive data of Tigrinya, the theoretical approaches to the phenomenon, the analysis of Tigrinya applicatives and the implementation of Tigrinya grammar.

Part II, which consists of chapters 4 ‘The applicative phenomenon’, 5 ‘Transitivity in applicative causes’ and 6 ‘Applicative vs. Oblique coding’, offers a detailed description of the Tigrinya applicative constructions, and it reviews the extensive literature on the subject. Since no study has previously been carried out on Tigrinya applicative constructions, the present research started by surveying these constructions. In chapter 4 applicative constructions are investigated with respect to their morphosyntactic coding and the type of semantic roles and discourse readings they express. We also offer cross-linguistic comparison in order to illustrate some of the parameters of variation on the types of semantic roles that languages allow and the type of markers they employ to code applied objects. Some languages have distinct markers for each applied argument, but some have polysemous markers that express several semantic role readings. In some languages applicative markers are object pronominal affixes, while in other languages applicative and object pronominal affixes are separate morphemes. The semantic roles that languages may admit by applicative coding include a recipient, beneficiary, maleficiary, goal, locative, directional, allative, ablative, source, comitative, reason, experiencer, circumstantial, possessor, etc. The most attested applied roles cross-linguistically are the beneficiary and the recipient/goal, followed by the locative and the instrumental.

Tigrinya employs two types of pronominal object suffixes which are termed as OM_1 and OM_2 in this work. The suffix OM_1 is commonly associated with patient-like arguments. It identifies the theme/patient object in monotransitive clauses, the theme and the recipient objects in ditransitive clauses, and the goal object in applicative clauses formed out of unergative movement verbs. In addition, it identifies ethically/psychologically affected applied objects which express a maleficiary, an experiencer or a possessor semantic role reading. The suffix OM_2 corresponds with secondary patient-like objects which are interpreted as indirectly implicated or partially affected applied arguments. This expresses semantic roles such as a beneficiary, a source, a locative or an instrumental applied object.

Chapter 5 discusses the transitivity property of applicative clauses from a typological point of view. The applicative phenomenon is often referred to as a transitivizing or valency-increasing device. We argued that these terms are somewhat too vague as a description of the various types of transitivity properties reflected by applicative clauses. We regard the transitivity that arises due to the applicative affixation as a increase in semantic valence and/or increase in syntactic valence

in the argument structure of applied predicates. We argued that not all applicative clauses are equally transitive. The transitivity effect that the applicative marker creates depends on the type of semantic roles it advances to core grammatical functions, and also on the semantics of the base verb. When the pronominal suffix OM₁ codes a recipient object of a verb like *wāhabä* ‘he gave her (something)’, *ʕadälä* ‘he distributed’, it does not lead to an increase in the number of arguments, neither semantic nor syntactic. The recipient object is a core grammatical function inherently marked with the objective case *ni-*. Both the theme and the recipient objects can be marked on the verb, but only one object at a time. Thus, the most salient/individuated object in the discourse context is prioritized for pronominal indexation. Because of this property the ditransitive clause can also be regarded as a basic clause.

Another type of transitivity property is reflected by applicative clauses that involve verbs such as *sädädä* ‘he sent’ and *ʔanibärä* ‘he put’. These verbs are lexically subcategorized for agent-theme-goal and agent-theme-locative arguments, respectively. When the verbs do not bear the suffix OM₂, the goal and the locative arguments are obliquely expressed in prepositional phrases that mark their specific semantic relation, but when the verb bears the object suffix to code the goal and locative arguments, these arguments are expressed as core object functions – i.e. as applied objects, and like other objects are coded with the objective case *ni-*. Hence, in these applicative predicates the syntactic valence is affected. On the other hand, when the object suffix codes an argument that is not entailed in the lexical reading of the verb, both the semantic and syntactic valences of the verb are affected. In applied verbs such as *gäziʔ-u-la* ‘he bought for her’, *ʔäfiʔ-u-wa/la* ‘he/it disappeared on/for her’ and *g^wäyi y-u-wa/la* ‘he ran after/for her’, the object suffix brings about an increase both in the number of semantic arguments, and also in the number of syntactic arguments. In Tigrinya the object suffixes can attach to ditransitive, transitive and intransitive verbs. With some ditransitive verbs the suffix OM₁ codes both the theme and the recipient objects, and both objects display primary patient-like properties. With some ditransitive verbs the suffix OM₂ is used for non-theme arguments, and these objects display secondary patient-like properties. Transitive verb bases allow the suffix OM₂ only. With these predicates this suffix codes a beneficiary, a maleficiary, a locative or an instrumental applied object. These applied arguments display secondary patient-like properties. Intransitive verbs allow either suffixes. The suffix OM₂ can be associated with secondary patient-like arguments, and the suffix OM₁ can be associated with primary patient-like arguments when

the intransitive verb is unergative, or when it expresses ethically/psychologically affected arguments with verbs whose semantics does not bring about genuine affectedness of objects.

Chapter 6 explores the dynamic and non-dynamic applicative systems in Tigrinya. The dynamic system refers to the existence of a productive parallelism between an applicative and a prepositional or an oblique expression of semantic participants. In contrast, the non-dynamic system refers to the lack of such parallelism, and thus the applicative expression becomes the only grammatical device to express certain arguments. Tigrinya possesses distinct prepositions to express locative, goal, source, instrumental, concern (about) and comitative semantic roles. In addition, it has a directional preposition *ni-* which expresses a range of semantic relations such as beneficiary, direction, purpose and reason readings. It is also used as a dative case of recipient objects and as an objective case of definite theme objects and applied objects. Out of these, concern, reason, purpose and comitative cannot be expressed by the applicative expression. On the other hand, the applicative expression of maleficiary, experiencer and possessor arguments is a non-dynamic system. The lack of systematic parallelism between oblique and applicative expressions justifies the non-derivational approach to the analysis of applicative constructions. Furthermore, the choice between the two strategies is argued to have semantic and functional motivation. The applied object selects distinct, referential and individuated referents. It expresses nuances such as distinctness, discreteness, containment, intensity and partiality, among others. The oblique expression is used to code indistinct, non-discrete and abstract. In addition, the applied object has discourse salience. Moreover, the actions affecting the applied argument are understood to be central in the discourse context.

Part III contains three chapters (7, 8 and 9) that present the analysis of applicative constructions. In chapter 7, 'Morphosyntactic approaches' we give a brief review of the analysis of applicative constructions in Relational Grammar and Government and Binding theories. Furthermore, we present Lexical Mapping Theory, the theory that is concerned with semantic argument to grammatical function mapping issues in LFG. RG posits grammatical relations such as subject, direct object, indirect object and oblique as theoretical primitives in terms of which rules, principles and constraints are formulated. In RG there is no separate level of representation between semantic arguments and their syntactic expression. It was mainly dedicated to showing the relation between alternative expressions such as the active-passive and oblique-applicative. It assigns a derivational analysis to such sentences

in which some of the grammatical relations are re-evaluated in the process. The applicative is regarded as an instance of advancement: oblique to applied object. However, as noted with respect to the Tigrinya data, the applicative and oblique expressions reflect semantic and discourse differences. Moreover, some applicative expressions do not have prepositional alternatives. Hence, RG cannot adequately characterize the applicative phenomenon. GB's account of applicatives is mainly credited to the work of Baker (1988a,b, 1990) on Bantu languages. Baker (1988a) analyzes the applicative phenomenon as an instance of head movement, where an adpositional marker moves from its structural position to incorporate into the verb. In GB changes in government or case relations are given configurational explanations. It posits an initial or underlying prepositional structure which is the base for the derivation of the applicative structure. Thus, both RG and GB offer derivational accounts of this phenomenon. However, we argue that the applicative construction needs an approach that treats it independent of the prepositional expression.

LFG makes possible such independence. Furthermore, LFG posits levels of representation which contain different linguistic information: argument structure, functional structure, and discourse structure. The applicative phenomenon is regarded as an operation that affects the mapping between the semantic participants in the argument structure and the grammatical function of the surface syntactic expression. However, there has been little research that accounts for the discourse function of applied objects in LFG. This chapter, 7.5, discusses LMT in detail, and reviews the analyses of Bantu applicative constructions proposed by Bresnan and Moshi (1990) and Alsina and Mchombo (1993), and the analysis of symmetrical applicatives given by Kibort (2007, 2008) in a version that she proposes as an extension to LMT. Applicative constructions vary with respect to the behavior of the objects they code. In asymmetrical type applicative languages the applied and the base objects display different primary object properties, whereas in symmetrical type applicative languages both object show similar primary object properties. Grammatical properties such as appearing adjacent to a verb, controlling pronominal indexation and undergoing passivization are assumed to compose a single primary object property, formalized as a $[-r]$ feature. Thus, in asymmetrical applicatives only the applied object is assumed to get the $[-r]$ classification, but in symmetrical applicatives both of them can get the $[-r]$ classification. Bresnan and Moshi propose that in symmetrical applicative constructions the theme/patient argument will get different intrinsic classifications based on whether the applied verb is active or passive. In the argument structure of the active applied predicate the pa-

tient is assigned the [+o] feature, whereas in the argument structure of the passive applied predicate the patient/theme is assigned the [-r] feature. Following Kibort (2008), we argue that this analysis conflicts with the explanation about the active-passive alternation maintained in LFG that the active and the passive predicates must share the same argument structure (Bresnan 2001:26). Moreover, the patient-like properties of the two arguments which is posited as a parameter of variation in symmetrical applicatives will be obscured if the theme is restricted to the [+o] feature.

In chapter 8, 'Tigrinya objects and LMT', we confront LMT with data from Tigrinya. Objects are investigated with respect to diagnostics such as word order, case marking, pronominal indexation, passivization and relativization. The default word order in Tigrinya is SOV. Verbal adjacency cannot be posited as a primary property of objects in this language. Clausal elements appear to be governed by the information structure roles they hold in the clause. Salient and topical referents appear in clause initial position, and non-salient and focus elements follow them. When grammatical functions are distinctly coded, in terms of case and pronominal indexation, they can leave their default position in order to render various pragmatically marked readings. Objects in double object clauses are distinguished by a complex interplay between word order, case marking and pronominal indexation. Recipient objects are obligatorily case marked with the objective case *ni-*, whereas theme objects are case marked only when they are definite. A recipient object and a definite theme object are coded in a fixed order, where the theme object obligatorily precedes the recipient object, since both appear identical in their case marking. In these clauses either of the objects can be cross-referenced with the pronominal marker OM_1 , and both object arguments can undergo passivization. Moreover, relativization cannot distinguish between objects in Tigrinya since all core objects can be relativized; however, it confirms the core grammatical status of applied objects. The only property that distinguishes the two objects of ditransitive clauses is the obligatoriness of the case marker *ni-* with the recipient object. In contrast, the applicative clause that involves a beneficiary object and a theme object does not reflect such restriction even when both appear the same in their case marking since only the beneficiary can be cross-referenced with the object pronominal suffix OM_2 . Moreover, since the pronominal suffix used with the beneficiary objects is different from the one that identifies theme object (OM_1), the clause cannot be ambiguous. The word order of the theme object and the applied object that bears a locative, a source or instrumental semantic role becomes fixed when the theme

object is definite. In this pattern, the applied object precedes the theme object. In the applicative expression of these semantic roles, only the theme argument can undergo passivization. Thus, pronominal indexation and passivization indicate uncorrelated properties with these objects.

The binary feature decomposition method cannot adequately capture all the complex patterns revealed by objects in Tigrinya. The recipient argument is restricted with respect to its case marking, but it is unrestricted with respect to pronominal indexation and passivization. The beneficiary, locative, instrumental and source arguments are unrestricted with respect to pronominal indexation and case marking, but are restricted with respect to passivization. We maintain that the different coding strategies work together to distinguish between objects, but they do not converge to form a single primary object property. Therefore, on the basis of coding strategies the primary and secondary object distinction cannot be maintained. Instead, we argue that pronominal indexation is discourse motivated. It associates only with salient and individuated objects. The discourse motivation for coding object is explored in chapter 9. On the other hand, passivization seems to target genuinely affected objects in Tigrinya. On the basis of passivization we can distinguish between genuinely/directly affected objects, and ethically/incidentally affected objects.

Chapter 9, 'Object topicality and DOM in Tigrinya', discusses the relationship between differential object marking (DOM) and discourse topicality of objects in Tigrinya. Some functional typologists assume that DOM is motivated by the need to distinguish the atypically prominent/individuated object from the subject which is regarded as the default topic. The strategy that is usually dealt with in these studies is case marking. We argued that the discriminatory view does not properly explain the motivation of pronominal indexation. Pronominal indexation is the behavioral potential of subjects. In Tigrinya subject indexation corresponds also with non-thematic, non-topical subjects. However, objects can only be marked when they correspond to highly individuated/prominent referents. Tigrinya involves both strategies in DOM. We assume that case marking has more of a discriminatory function. When grammatical functions are different with respect to their case marking, they can shift position. However, when they look similar, either because they are unmarked or are identically marked, they are coded in a fixed position. On the other hand, pronominal indexation codes a property which is not present in the unmarked object, and that is individuation. In monotransitive clauses only objects that have definite/specific referents can acquire case marking and pronominal indexa-

tion, and those which lack such properties are unmarked. DOM does not induce change in the grammatical function of marked objects. Both unmarked and marked objects assume the same object function. We use the same reasoning in analyzing objects in double object and applicative clauses. We maintain that the same criteria that motivate DOM in monotransitive clauses also motivate object marking in ditransitive and applicative clauses. Patterns of objects that occur in clauses with ditransitive, as well as applied verb formed from transitive and intransitive base verbs support this claim. In Tigrinya when two objects that display similar semantic dispositions, such as definiteness/humanness, occur in a ditransitive clause, the object that is most salient in the discourse context wins over the other for pronominal marking. The object that controls pronominal indexation is the most topical entity in the discourse. Moreover, applied objects that co-occur with athematic or with less prominent subjects tend to appear in clause initial position. In most clauses that show the OSV or OV word order pattern, case marking becomes optional. We regard such behavior to be typical of topic objects. When the applied object is the most salient argument in the clause, it tends to be unmarked for the objective case, as the subject is. Therefore, the discourse motivation for pronominal indexation explains why applied arguments that do not possess primary object properties with respect to passivization can control pronominal indexation. Applied objects may or may not correspond to primary patient-like arguments, but they are all unified under the topic function.

Chapter 10 and this conclusion chapter are grouped under Part IV. Chapter 10, 'XLE implementation of Tigrinya', presents the implementation of the computational grammar of Tigrinya. The implemented LFG grammar situates the description and analysis of applicative constructions in the context of the general grammar of Tigrinya. The grammar has limited coverage. It can account for various nominal phrases, and the basic clause. This grammar can account for word order, case marking and pronominal suffix constraints that are employed to license a well-formed construction in Tigrinya. Issues such as word order variation, word order freezing, marking of indefinite and definite objects (differential object marking) and pro-drop are accounted for. We have also illustrated the analysis of the passive. We have shown the different mapping patterns found in passive forms of ditransitive verbs and applied predicates of transitive and intransitive verbs. Ditransitive predicates are subcategorized for an OBJ and an OBJgoal, and the arguments of both objects display genuine patient-like properties. Either of them can be expressed as subject in a passive predicate. Applicatives formed from transitive predicates are

subcategorized for an OBJ and an OBJappl. In these clauses only OBJ shows genuine patient-like properties. With transitive predicates OBJappl can also express a partitive reading of the theme argument which is perceived as being partially affected argument. We have also presented analysis of applied objects subcategorized for by intransitive applied predicates. In these constructions applied objects can correspond either OM₁ or OM₂ to express various readings of affectedness. However, due to time constraints our implementation does not include the information structure role allotted to marked objects. We postpone this for future research.

Our finds suggest that LMT's account of object asymmetries via feature decomposition needs revision. LFG provides a suitable model that assumes various inter-related parallel representations that can handle the different linguistic information coded by applicative clauses. Linguistic information about the word order of elements, the argument structure of applied predicates, the grammatical functions and information structure roles that the arguments of applied predicates may assume in the applicative clause can be handled with the general theoretical apparatus of LFG. However, the theory of object asymmetries formulated as LMT within LFG, restricts the general declarative nature of LFG by assuming strict binary categories of object functions, namely OBJ and OBJ_θ, on the basis of properties that do not appear to converge to a single feature across languages. In our analysis of Tigrinya we assume that there can be subtypes of objects that reflect genuine affectedness properties in the same clause, as there can be several OBJ_θ functions. In ditransitive clause the theme object and the recipient object reflect genuine affectedness properties with respect to passivization and pronominal indexation, but they cannot be analyzed as having a unique grammatical function (OBJ) on the basis of these properties alone since they are also distinguishable by their case and word order patterns. Therefore, further research is required to explore the implications of our assumptions of object classifications to other languages.

BIBLIOGRAPHY

- Abba Mathewos, Hagos. 1951. ሰዋሰው ትግርኛ [Tigrinya Grammar], volume 1. Asmara, Eritrea: Francescana Printing Press.
- Ackerman, Farrell. 1990. Locative alternations vs. locative inversion. In Aaron L. Harpern (ed.), *The Proceedings of the Ninth West Coast Conference on Formal Linguistics*, Stanford, CA: CSLI Publications.
- Ackerman, Farrell. 1992. Complex Predicates and Morpholexical Relatedness: Locative Alternation in Hungarian. In I. Sag and A. Szabolcsi (eds.), *Lexical Matters*, page 55–83, CSLI Publications.
- Ackerman, Farrell and Moore, John. 2001. Proto-properties and Grammatical Encoding. *A Correspondence Theory of Argument Selection*. Stanford, CA: CSLI Publications.
- Aissen, Judith. 1983. Indirect Object Advancement in Tzotzil. In David Perlmutter (ed.), *Studies in Relational Grammar*, volume 1, page 325–366, Chicago: University of Chicago Press.
- Aissen, Judith. 2003. Differential Object Marking: Iconicity vs. Economy. *Natural Language and Linguistic Theory* 21(3), 435–483.
- Alsina, Alex. 1990. *The Role of Argument Structure in Grammar: Evidence from Romance*. CSLI Publications.
- Alsina, Alex. 1996. Passive Types and The Theory of Object Asymmetries. *Natural Language and Linguistic Theory* 14, 673–723.
- Alsina, Alex and Mchombo, Sam A. 1990. The syntax of applicatives in Chichewa: Problems for a theta theoretic asymmetry. *Natural Language and Linguistic Theory* page 493–506.

- Alsina, Alex and Mchombo, Sam A. 1993. Object Asymmetries and the Chichewa Applicative Construction. In Sam Mchombo (ed.), *Theoretical Aspects of Bantu Grammar*, volume 1, Chapter 1, page 17–45, Stanford, CA: CSLI Publications.
- Amberber, Mengistu. 1996. *Transitivity Alternation, Event Types and Light Verbs*. Ph. D. thesis, McGill University, Montréal, Québec, Canada.
- Amberber, Mengistu. 2000. Valency-changing and valency-encoding devices in Amharic. In R.M.W. Dixon and Alexandra Y. Aikhenvald (eds.), *Changing Valency: Case Studies in Transitivity*, page 312–331, Cambridge University Press.
- Amberber, Mengistu. 2005. Differential Subject Marking in Amharic. In Mengistu Amberber and Helen De Hoop (eds.), *Competition and Variation in Natural Languages*, Elsevier.
- Andrews, Avery. 1985. The major functions of the noun phrase. In Timothy Shopen (ed.), *Clause Structure*, volume I of *Language Typology and Syntactic Description*, Chapter 2, page 62–154, Cambridge, UK: Cambridge University Press.
- Appleyard, David. 2001. The verb ‘to say’ as a verb “recycling device” in Ethiopian languages. In Zaborski Andrzej (ed.), *New data and new methods in Afroasiatic linguistics: Robert Hetzron in memoriam*, Chapter 1, pages 1–11, Wiesbaden: Harrassowitz Verlag.
- Arche, María J. 2006. Individuals in time: tense, aspect and the individual/stage distinction, volume 94 of *Linguistics Today*. Amsterdam: John Benjamins Publishing Company.
- Asudeh, Ash. 2004. Direct Compositionality and the Architecture of LFG. In Miriam Butt, Mary Dalrymple and Tracy Holloway King (eds.), *Intelligent Linguistic Architectures: Variations on Themes by Ronald M. Kaplan*, page 363–387, CSLI Publications.
- Azeb, Amha and Dimmendaal, Gerrit. 2006. Coverbs in an African perspective. In K. Felix Ameka, Alen Dench and Nicholas Evans (eds.), *Catching Language: The standing challenge of grammar writing*, *Trends in Linguistics: Studies and Monographs*, No. 167, page 393–440, Mouton de Gruyter.
- Baker, Mark. 1988a. *Incorporation: A Theory of Grammatical Function Changing*. Chicago: University of Chicago Press.
- Baker, Mark. 1988b. Theta Theory and the Syntax of Applicatives in Chichewa. *Natural Language and Linguistic Theory* 6, 353–389.
- Baker, Mark. 1990. Elements of a Typology of Applicatives in Bantu. In P. John Hutchingson and V. Manfredi (eds.), *Current Approaches to African linguistics*, page 111–124, Dordrecht, Boston and London: Foris Publications.

- Baker, Mark. 1996. *The Polysynthesis Parameter*. New York: Oxford University Press.
- Bernini, Giuliano. 2003. The copula in learner Italian: Finiteness and verbal inflection. In Christine Dimroth and Marianne Starren (eds.), *Information structure and the dynamics of language acquisition, Studies in Bilingualism*, page 159–185, Amsterdam and Philadelphia: John Benjamins Publishing Company.
- Bierwisch, Manfred. 2003. Heads, Complements and Adjuncts: Projection and saturation. In Lang Ewald, Claudia Maienborn and Cathrine Fabricius-Hansen (eds.), *Modifying Adjuncts, Interface Explorations*, No. 4, Mouton De Gruyter.
- Black, Cheryl A. 1997a. Introduction to Government and Binding theory: Binding theory. *Notes on Linguistics* 78, 5–24, available online.
- Black, Cheryl A. 1997b. A step-by-step introduction to the Government and Binding theory of syntax. Available online.
- Blake, Barry J. 1990. *Relational Grammar*. London and New York: Routledge.
- Blansitt, Edward L. 1988. Datives and Allatives. In Michael Hammond, Edith Moravcsik and Jessica Wirth (eds.), *Studies in Syntactic Typology*, page 173–191, Amsterdam: John Benjamins.
- Börjars, Kersti, Payne, John and Chisarik, Erika. 1999. On the justification for functional categories in LFG. In Miriam Butt and Tracy Holloway King (eds.), *Proceedings of the LFG'99 Conference*, CSLI Publications.
- Börjars, Kersti and Vincent, Nigel. 2008. Objects and OBJ. In Miriam Butt and Tracy Holloway King (eds.), *Proceedings of the LFG'08 Conference*, Stanford, CA: CSLI Publications.
- Bossong, Georg. 1985. *Empirische Universalienforschung: Differentielle Objektmarkierung in den Neuiranischen Sprachen*. Tübingen: Gunter Narr.
- Bossong, Georg. 1991. Differential Object Marking in Romance and Beyond. In D. Wanner and D. Kibbee (eds.), *New Analyses in Romance Linguistics: Selected papers from the XVIII Linguistic Symposium on Romance Languages*, page 143–170, Urbanan, Champaign: John Benjamins.
- Bresnan, Joan. 1982a. Control and Complementation. In Joan Bresnan (ed.), *The Mental Representation of Grammatical Relations*, Chapter 5, page 282–390, MIT Press.
- Bresnan, Joan (ed.). 1982b. *The Mental Representation of Grammatical Relations*. MIT Press.
- Bresnan, Joan. 1982c. The Passive in Lexical Theory. In Joan Bresnan (ed.), *The Mental Representation of Grammatical Relations*, Chapter 1, page 3–86, The

- MIT Press.
- Bresnan, Joan. 1994. Locative Inversion and the Architecture of Universal Grammar. *Language* 70(1), 72–131.
- Bresnan, Joan. 2001. *Lexical-Functional Grammar*. Oxford: Blackwell.
- Bresnan, Joan and Kanerva, Jonni. 1989. Locative Inversion in Chichewa: A Case Study of Factorization in Grammar. *Linguistic Inquiry* 20(1), 1–50.
- Bresnan, Joan and Mchombo, Sam. 1987. Topic, Pronoun, and Agreement in Chichewa. *Language* 63(4), 741–782.
- Bresnan, Joan and Moshi, Lioba. 1990. Object Asymmetries in Comparative Bantu Syntax. *Linguistic Inquiry* 21, 147–185.
- Bresnan, Joan and Moshi, Lioba. 1993. Object Asymmetries in Comparative Bantu Syntax. In Sam Mchombo (ed.), *Theoretical Aspects of Bantu Grammar*, volume 1, Chapter 2, page 47–87, Stanford, CA: CSLI Publications.
- Bresnan, Joan and Nikitina, Tatiana. 2003. On the Gradience of the Dative Alternation, manuscript.
- Bresnan, Joan and Nikitina, Tatiana. 2007. The Gradience of the Dative Alternation. In Linda Uyechi and Lian-Hee Wee (eds.), *Reality Exploration and Discovery: Pattern Interaction in Language and Life*, Stanford: CSLI Publications.
- Bresnan, Joan and Zaenen, Annie. 1990. Deep Unaccusativity in LFG. In K. Dziwiewik, P. Farrell and E. Mejias-Bikandi (eds.), *Grammatical relations. A cross-theoretical perspective*, page 45–57, CSLI Publications.
- Brindle, Jonathan Allen. 2005. On the Notion of Bare and Evaluated Controllers in Tigrinya. Masters Thesis, Norges Teknisk-Naturvitenskapelige Universitet.
- Brindle, Jonathan Allen. 2006. Uncovering regularities: On Bare and Evaluated Controllers in Tigrinya. In Stefan Müller (ed.), *Proceedings of the 13th International Conference on Head-Driven Phrase Structure Grammar*, page 381–401.
- Broadwell, George Aaron. 1998. Directionals as complex predicates in Choctaw. In Miriam Butt and Tracy Holloway King (eds.), *Proceedings of the LFG'98 Conference*, Stanford, CA: CSLI Publications.
- Bruce, Les. 1984. *The Alambalak Language of Papua New Guinea (East Sepik)*. Pacific Linguistics, C, No. 81, Canberra: Australian National University.
- Buckley, Eugene. 1997. Against vowel length in Tigrinya. *Studies in African Linguistics* 26(1), 63–102.
- Butt, Miriam. 1995. *The Structure of Complex Predicates in Urdu*. Dissertation in Linguistics, Stanford, CA: CSLI Publications.
- Butt, Miriam. 1997. Complex Predicates in Urdu, page 107–149. CSLI Publica-

- tions.
- Butt, Miriam. 2006. *Theories of Case*. Cambridge University Press.
- Butt, Miriam and King, Tracy Holloway (eds.). 1996. *Structural Topic and Focus Without Movement*, Stanford, CA, Proceedings of the LFG'96 Conference, CSLI Publications.
- Butt, Miriam and King, Tracy Holloway. 2000. Null Elements in Discourse Structure. In K. V. Subbarao (ed.), *Papers from the NULLS Seminar*, Delhi: Motilal Banarsidass.
- Butt, Miriam and King, Tracy Holloway. 2007. Urdu in a parallel grammar development environment. *Language Resources and Evaluation* 41, 191–207.
- Butt, Miriam, King, Tracy Holloway, Niño, Maria-Eugenia and Segond, Frédérique. 1999. *A Grammar Writer's Cookbook*. Stanford, CA: CSLI Publications.
- Bybee, Joan L. 1985. *Morphology: A Study of the Relation between Meaning and Form*. Amsterdam: John Benjamins.
- Carochi s.j., Horacio. 2001. *Grammar of the Mexican Language, with an Explanation of its Adverbs (1645)*. Stanford University Press.
- Çetinoğlu, Özlem and Butt, Miriam. 2008. Turkish Noncanonical Objects. In Miriam Butt and Tracy Holloway King (eds.), *Proceedings of the LFG'08 Conference*, page 214–234, CSLI Publications.
- Chafe, Wallace. 1976. Givenness, contrastiveness, definiteness, subjects, topics, and point of view. In N. Li, Charles (ed.), *Subjects and Topics*, page 27–55, New York: Academic Press.
- Choi, Hye-Won. 1999. *Optimizing Structure in Context: Scrambling and Information Structure*. Stanford, CA: CSLI Publications.
- Chomsky, Noam. 1957. *Syntactic Structures*. Berlin: Mouton De Gruyter.
- Chomsky, Noam. 1965. *Aspects of the Theory of Syntax*. Cambridge, Massachusetts: The MIT Press.
- Chomsky, Noam. 1981. *Lectures on Government and Binding: The Pisa Lectures*. Dordrecht: Foris Publications.
- Chomsky, Noam. 1986. *Knowledge of Language: Its Nature, Origin, and Use*. New York: Praeger.
- Chung, Sandra. 1976. An Object-Creating Rule in Bahasa Indonesia. *Linguistic Inquiry* 7, 1–37.
- Chung, Sandra. 1983. An Object-Creating Rule in Bahasa Indonesia. In M. David Perlmutter (ed.), *Studies in Relational Grammar*, volume 1, page 219–271,

- Chicago and London: The University of Chicago Press.
- Comrie, Bernard. 1975. The antiergative: Finland's answer to Basque. In *Papers from the 11th regional meeting of the Chicago Linguistic Society*, page 112–121, Chicago: CLS.
- Comrie, Bernard. 1977. Subjects and direct objects in Uralic languages: A functional explanation of case-marking systems. *Études Finno-Ougriennes* 12, 5–17.
- Comrie, Bernard. 1979. Definite and animate direct objects: A natural class. *Linguistica Silesiana* III, 13–21.
- Comrie, Bernard. 1985. Causative verb formation and other verb-deriving morphology. In *Language typology and syntactic description, volume III of Grammatical categories and the lexicon*, page 309–348, Cambridge University Press.
- Comrie, Bernard. 1989. *Language universals and linguistic typology*. Chicago: The University of Chicago Press, second edition.
- Comrie, Bernard. 2003. When agreement gets trigger-happy. *Transactions of the Philological Society* 102(2).
- Croft, William A. 1988. Agreement vs. case marking and direct objects. In Michael Barlow and Charles A. Ferguson (eds.), *Agreement in Natural Languages: Approaches, Theories, Descriptions*, page 159–179, Stanford, CA: CSLI Publications.
- Crystal, David. 1985. *A Dictionary of Linguistics and Phonetics*. Oxford, UK: Blackwell.
- Dalrymple, Mary. 2001. *Lexical Functional Grammar, volume 34 of Syntax and Semantics*. San Diego: Academic Press.
- Dalrymple, Mary, Kaplan, Ronald M., Maxwell, John T. and Zaenen, Annie. 1995. *Formal Issues in Lexical-Functional Grammar, volume 47*. Stanford, CA: CSLI Publications.
- Dalrymple, Mary and Nikolaeva, Irina. 2005. Nonsubject agreement and discourse roles. In *Oxford Working Papers in Linguistics, Philology and Phonetics* 9.
- Dalrymple, Mary and Nikolaeva, Irina. 2007. Topicality and nonsubject marking: Agreement, casemarking, and grammatical function. MS, 2007.
- Dalrymple, Mary and Nikolaeva, Irina. 2011. *Objects and Information Structure*. Cambridge Studies in Linguistics, No. 131, Cambridge University Press.
- De Hoop, Helen and Narasimhan, Bhuvana. 2005. Differential case-marking in Hindi. In Mengistu Amberber and Helen De Hoop (eds.), *Competition and Variation in Natural Languages: the case for case, Perspectives on Cognitive Science*, page 322–344, Amsterdam: Elsevier.

- Dillmann, August and Bezold, Carl. 2005. *Ethiopic Grammar*. Eugene, Oregon: Wipf and Stock, second edition.
- Dixon, R.M.W. 1988. *A Grammar of Boumaa Fijian*. Chicago: University of Chicago Press.
- Dixon, R.M.W. and Aikhenvald, Alexandra Y. 2000. Introduction. In R.M.W. Dixon and Alexandra Y. Aikhenvald (eds.), *Changing Valency: Case Studies in Transitivity*, Chapter 1, page 1–29, Cambridge University Press.
- Dixon, R.M.W. and Vogel, Alan R. 2004. *The Jarawara Language of Southern Amazonia*. Oxford, UK: Oxford University Press.
- Donohue, Cathryn and Donohue, Mark. 2004. On the special status of instrumentals. In Butt Miriam and King Tracy Holloway (eds.), *Proceedings of the LFG04 Conference*, page 209–225, Stanford, CA: CSLI Publications.
- Donohue, Mark. 1994. The applicative construction in Tukung Besi. In Cecilia Ode and Wim Stokhof (eds.), *Proceedings of the Seventh International Conference on Austronesian Linguistics*, page 415–254, Leiden University, Rodopi.
- Donohue, Mark. 1996. Relative Clauses in Tunkan Besi: Grammatical Functions and Thematic Roles. *Linguistic Analysis* 26(3–4), 159–173.
- Donohue, Mark. 2001. Coding choices in argument structure. *Studies in Language* 25(2), 217–254.
- Dowty, David. 1982. Grammatical relations and Montague Grammar. In Pauline Jacobson and Geoffrey Pullum (eds.), *The Nature of Syntactic Representation*, page 79–130, Dordrecht: Reidel.
- Dowty, David. 1991. Thematic Proto-Roles and Argument Selection. *Language* 67(3), 547–619.
- Dryer, S. Matthew. 1983. Indirect Objects in Kinyarwanda Revisited. In David Perlmutter (ed.), *Studies in Relational Grammar*, volume 1, page 129–140, Chicago: University of Chicago Press.
- Dryer, S. Matthew. 1986. Primary Objects, Secondary Objects and Antidatives. *Language* 62, 808–845.
- Esayas, Tajebe. 2003. *Nominal Functional Categories in Tigrinya*. Masters Thesis, Addis Abeba University, School of Graduate Studies, Addis Abeba, Ethiopia.
- Falk, Yehuda. 1984. The English Auxiliary System: A Lexical-Functional Analysis. *Language* 60, 483–509.
- Falk, Yehuda. 2001. *Lexical-Functional Grammar*. Stanford, CA: CSLI Publications.
- Falk, Yehuda N. 2007. Hebrew Present-Tense Copula Constructions: The view

- from parallel syntax. (available online).
- Farkas, Donka. 1978. Direct and Indirect Object Reduplication in Romanian. In *Papers from the Fourteenth Regional Meeting of the Chicago Linguistic Society*, page 88–97.
- Ferguson, Charles. 1970. The Ethiopian Language Area. *The Journal of Ethiopian Studies* 8(2), 67–80.
- Foley, William. 1997. Polysynthesis and Complex Verb Formation: The case of applicatives in Yimas. In Joan Bresnan, Alex Alsina and Peter Sells (eds.), *Complex Predicates*, page 355–495, CSLI Publications.
- Gaarder, Jostein. 1991. *Sofies verden*. Oslo: Aschehoug.
- Gair, James. 1970. *Colloquial Sinhalese Clause Structure*. The Hague: Mouton.
- Gary, Judith. 1977. Implications for Universal Grammar of Object-Creating Rules in Luyia and Mashi. *Studies in African Linguistics* 7, 85–95.
- Gary, Judith and Keenan, Edward L. 1977. On Collapsing Grammatical Relations in Universal Grammar. In Peter Cole and Jerrold Sadock (eds.), *Grammatical Relations, Syntax and Semantics*, No. 8, New York: Academic Press.
- Gerdts, Donna B. 1980. Causal to Object Advancement in Halkomelem. *Chicago Linguistic Society* 16, 83–101.
- Gerdts, Donna B. 1988. *Object and Absolutive in Halkomelem Salish*. New York: Garland.
- Gerdts, Donna B. and Kiyosawa, Kaoru. 2005. The function of Salish applicatives. In *Proceedings of the Twenty-sixth Annual Meeting of the Berkeley Linguistic Society*, page 51–62, Berkeley, California.
- Gerdts, Donna B. and Kiyosawa, Kaoru. 2006. Discourse functions of Salish applicatives. In *Papers for the 40th International Conference of Salish and Neighbouring Languages, UBCWPL*, page 129–145.
- Gerdts, Donna B. and Kiyosawa, Kaoru. 2007. Combination properties of Salish applicatives. In *Papers for the 42nd International Conference of Salish and Neighboring Languages, UBCPL*, page 176–219.
- Girma, Awgichew Demeke. 2003. *The Clausal Syntax of Ethio-Semitic*. Ph. D. thesis, Department of Linguistics, University of Tromsø, Tromsø.
- Givón, Talmy. 1976. Topic, Pronoun, and Grammatical Agreement. In Charles N. Li (ed.), *Subject and Topic*, New York: Academic Press.
- Givón, Talmy. 1978. Definiteness and Referentiality. In J. Greenberg (ed.), *Universals of Human Language*, volume 4, page 291–330, Stanford, CA: Stanford University Press.

- Givón, Talmy. 1983. Topic-Continuity in Discourse: A Qualitative Cross-Language Study, volume 3 of *Typological Studies in Language*. Amsterdam: John Benjamins.
- Gongordo, Zelal and Oflazer, Kemal. 1995. Parsing Turkish Using the Lexical Functional Grammar Formalism. *Machine Translation* (10), 293–319.
- Gragg, B. Gene. 1972. Cleft Sentences in Tigrinya. *Journal of African Languages* 11, 74–88.
- Gragg, Gene. 1997. Ge'ez. In Robert Hetzron (ed.), *The Semitic Languages*, Routledge Language Family Description, page 242–260, Routledge.
- Grimshaw, Jane. 1990. *Argument Structure*. Cambridge, Massachusetts: The MIT Press.
- Gruber, Jeffrey. 1965. A study in lexical relations. Ph.D.thesis, MIT.
- Halliday, Michael A. K. 1967. Notes on Transitivity and theme in English. *Journal of Linguistics* 1, 199–244.
- Harford, Carolyn. 1993. The Applicative in Chishona and Lexical Mapping Theory. In Sam A. Mchombo (ed.), *Theoretical Aspects of Bantu Grammar*, volume 1, Chapter 3, Stanford, CA: CSLI Publications.
- Haspelmath, Martin. 2004. Argument marking in ditransitive alignment types. *Linguistic Discovery* 31(1), 1–21.
- Haspelmath, Martin. 2008. Ditransitive Constructions: Towards a New Role and Reference Grammar Account? In Robert D. Van Valin (ed.), *Investigations of the Syntax-Semantics-Pragmatics Interface*, volume 105 of *Studies in Language Companion*, John Benjamins.
- Heath, Jeffrey. 1999. A Grammar of Koyraboro (Koroboro) Senni: The Songhay of Gao, Mali, volume 19 of *Westafrikanische Studien*. Cologne: Rüdiger Köppe Verlag.
- Hegarty, Michael. 2003. Semantic types of abstract entities. *Lingua* 113, 891–927.
- Heine, Bernd. 1997. *Possession: Cognitive sources, Forces and Grammaticalization*. Cambridge University Press.
- Hetzron, Robert. 1972. *Ethiopian Semitic: Studies in Classification*. Manchester University Press.
- Hetzron, Robert. 1975. Genetic classification and Ethiopian Semitics. In James Bynon and Theodora Bynon (eds.), *Hamito-Semitic*, page 103–125, The Hague: Mouton.
- Hewitt, B. George. 1979. Abkhaz. *Lingua Descriptive Studies*, No. 2, North Holland (now Croom Helm).

- Hopper, P. J. and Thompson, A. S. 1980. Transitivity in Grammar and Discourse. *Language* 56, 251–299.
- Huang, Chu-Ren. 1993. Mandarin Chinese and the Lexical Mapping Theory: A Study of the Interaction of Morphology and Argument Changing. *Bulletin of the Institute of History and Philosophy: Academia Sinica* 62(2), 337–388.
- Jackendoff, Ray. 1990. *Semantic Structure*. Cambridge, USA: MIT Press.
- Kaplan, M. Ronald and Bresnan, Joan. 1982. Lexical-Functional Grammar: A formal system for Grammatical Representation. In *The Mental Representation of Grammatical Relations*, Chapter 4, page 173–281, Cambridge, MA and London, England: MIT Press.
- Kaplan, M. Ronald and Maxwell, III John T. 1996. LFG grammar writer's workbench. Xerox Corporation.
- Keenan, Edward L. and Comrie, Bernard. 1977. NP Accessibility and Universal Grammar. *Linguistic Inquiry* 8, 63–100.
- Khan, Geoffrey. 1984. Object Markers and Agreement Pronouns in Semitic Languages. *Bulletin of the School of Oriental and African Studies, University of London* 47(3), 468–500.
- Kibort, Anna. 2004. *Passive and Passive-Like Constructions in English and Polish*. Ph.D.thesis, University of Cambridge, Cambridge, UK.
- Kibort, Anna. 2007. Extending the applicability of Lexical Mapping Theory. In Miriam Butt and Tracy Holloway King (eds.), *Proceedings of the LFG'07 Conference*, page 250–270.
- Kibort, Anna. 2008. On the Syntax of Ditransitive Constructions. In Miriam Butt and Tracy Holloway King (eds.), *Proceedings of the LFG08 Conference*, page 313–332, Stanford, CA: CSLI Publications.
- Kimenyi, Alexandre. 1980. *A Relational Grammar of Kinyarwanda*. Berkeley, California: University of California Press.
- King, Tracy Holloway. 1995. *Configuring Topic and Focus in Russian*. Dissertation in Linguistics, Stanford, CA: CSLI Publications.
- King, Tracy Holloway. 1997. Focus Domains and Information-structure. In Miriam Butt and Tracy Holloway King (eds.), *Proceedings of the LFG'97 Conference*, Stanford, CA: CSLI Publications.
- King, Tracy Holloway and Zaenen, Annie. 2004. F-structures, Information Structure, and Discourse Structure. In Miriam Butt and Tracy Holloway King (eds.), *Proceedings of the LFG'04 Conference*, CSLI Publications.
- Kiparsky, P. 1987. *Morphology and Grammatical Relations*. Masters Thesis, De-

- partment of Linguistics, Stanford University, Stanford, CA.
- Kiyosawa, Kaoru. 2006. *Applicatives in Salish Languages*. Ph.D.thesis, Simon Fraser University, Burnaby, Canada.
- Koenig, Jean-Pierre, Mauner, Gail and Bienvenue, Breton. 2003. Arguments for Adjuncts. *Cognition* 89, 67–103.
- Kogan, Leonid E. 1997. *Tigrinya*, Chapter 18, page 424–445. Routledge.
- Krifka, Manfred. 2004. Semantic and pragmatic conditions for the Dative Alternation. *Korean Journal of English Language and Linguistics* 4, 1–32.
- Kroeger, Paul. 1993. *Phrase Structure and Grammatical Relations in Tagalog*. Ph.D.thesis, Stanford University, Stanford, CA.
- Kroeger, Paul R. 2004. *Analyzing Syntax: A Lexical-functional Approach*. Cambridge, UK: Cambridge University Press.
- Kroeger, Paul R. 2007. Morphosyntactic vs. morphosemantic functions of Indonesian *kan*. In Annie Zaenen, Jane Simpson, Tracy Holloway King, Jane Grimshaw, Joan Maling and Chris Manning (eds.), *Architectures, Rules, and Preferences: Variations on Themes by Joan W. Bresnan*, page 229–252, CSLI Publications.
- Kulick, Don and Stroud, Christopher. 1992. The structure of the Taiap (Gapun) Language. In *The Language Game: Papers in Memory of Donald C. Laycock*, volume 110 of *Pacific Linguistics, C*, page 203–226, Canberra: Australian National University.
- Kulikov, Leonid, Malchukov, Andrej and de Swart, Peter. 2006. Introduction. In Leonid Kulikov, Andrej Malchukov and Peter de Swart (eds.), *Case, Valency and Transitivity*, Amsterdam and Philadelphia: John Benjamins.
- Lambrecht, Knud. 1998. *Information structure and sentence form: Topic, focus and the mental representation of discourse referents*. Cambridge University Press, second edition.
- Lee, Hanjung. 2001. Markedness and word order freezing. In Sells Peter (ed.), *Formal and Empirical Issues in Optimality Theoretic Syntax*, volume 5 of *Studies in Constraint based Lexicalism*, Stanford: CSLI Publications.
- Lee, Hanjung. 2003. Prominence Mismatch and Markedness Reduction in Word Order. *Natural Language and Linguistic Theory* 21(3), 617–680.
- Leonessa, Padre Mauro Da. 1928. *Grammatica analitica della lingua tigray*. Rome, Italy: Tipografia Vaticana.
- Leslau, Wolf. 1941. Document Tigrigna, volume XLVIII. *La Société de Linguistique de Paris*.
- Leslau, Wolf. 1945. The influence of Cushitic languages on the Semitic languages

- of Ethiopia: A problem of substratum. *Word* 1, 59–82.
- Leslau, Wolf. 1952. The influence of Gurage on the Ethiopian Semitic Languages. *Language* 28, 63–81.
- Levin, Beth and Rappaport Hovav, Malka. 1995. *Unaccusativity*. Massachusetts: The MIT Press.
- Levin, Beth and Rappaport Hovav, Malka. 2006. *Argument Realization*. Cambridge, UK: Cambridge University Press.
- Levin, Beth and Rappaport Hovav, Malka. 2008a. *Dative Verbs and Dative Alternations from a Crosslinguistic Perspective*, *handout*.
- Levin, Beth and Rappaport Hovav, Malka. 2008b. *Lexical Conceptual Structure*. In Claudia Maienborn, Klaus von Heusinger and Paul Portner (eds.), *Semantics: An International Handbook of Natural Language Meaning*, Berlin: Mouton de Gruyter.
- Levin, Lori S. 1988. *Operations on Lexical Forms: Unaccusative Rules in Germanic Languages*. New York and London: Garland Publishing, Inc.
- Lewis, M. Paul (ed.). 2009. *Ethnologue: Languages of the World*. Dallas, TX: SIL International, 16. edition.
- Lipiński, Edward. 1997. *Semitic Languages: Outline of a Comparative Grammar*, volume 80 of *Orientalia Lovaniensia Analecta*. Leuven: Uitgeverij Peeters.
- Lødrup, Helge. 1999. Linking and Optimality in the Norwegian Presentational Focus Construction. *Nordic Journal of Linguistics* 22(2), 205–229.
- Loogman, Alfons. 1965. *Swahili grammar and syntax*, volume XXI of *Duquesne Studies: African Series*, 1. Pittsburgh: Duquesne University Press.
- Luraghi, Silvia. 2003. *On the meaning of prepositions and cases: The expression of semantic roles in ancient Greek*. *Studies in Language Companion Series (SLCS)*, John Benjamins Publishing Company.
- Lyons, Christopher. 1999. *Definiteness*, volume 67 of *Cambridge Textbooks in Linguistics*. Cambridge, UK: Cambridge University Press.
- Machobane, 'Malillo 'Matsepo. 1989. *Some Restrictions on the Sesotho Transitivity Morphemes*. Ph.D.thesis, McGill University, Canada.
- Malchukov, Andrej, Haspelmath, Martin and Comrie, Bernard. 2007. *Ditransitive Constructions: A Typological Overview*, *manuscript*.
- Marantz, Alec. 1984. *On the Nature of Grammatical Relations*. Cambridge, USA: The MIT Press.
- Martin, Jack B. 2000. *Creek Voice: Beyond valency*. In R. M. W. Dixon and Alexandra Y. Aikhenvald (eds.), *Changing Valency: Case Studies in Transitivity*,

- page 375–403, Cambridge, UK: Cambridge University Press.
- Masson, John. 1994. *Tigrinya Grammar*. Ghinda, Eritrea: American Evangelical Mission.
- Matthews, H. Peter. 2007. *Concise Dictionary of Linguistics*. Oxford University Press, second edition.
- Mchombo, Sam. 1997. Contribution of African Languages to Generative grammar. In RK Herbert (ed.), *African Linguistics at the Crossroads: Papers from Kwaluseni*, page 179–209, Köln: Rüdiger Köppe.
- Mohanan, Tara. 1990. *Argument Structure in Hindi*. Ph. D.thesis, Stanford University.
- Mohanan, Tara. 1992. *Word Order in Hindi*, paper presented at the Syntax Workshop at Stanford University.
- Mohanan, Tara. 1994. *Argument Structure in Hindi*. CSLI Publications.
- Morimoto, Yukiko. 2002. Prominence Mismatches and Differential Object marking in Bantu. In Miriam Butt and Tracy Holloway King (eds.), *Proceedings of the LFG02 Conference*, Stanford, CA: CSLI publications.
- Morimoto, Yukiko. 2009. From Topic to Subject Marking: Implications for a Typology of Subject Marking. In Helen de Hoop and Peter de Swart (eds.), *Differential Subject Marking*, page 199–221, Dordrecht: Springer.
- Müller-Gotama, Franz. 1994. *Grammatical relations. A cross-linguistic perspective on their syntax and semantics*. Berlin: Mouton de Gruyter.
- Mulugeta, Girmay Melles. 2001. *Tigrinya Reader and Grammar*. Springfield, USA: Dunwoody Press.
- Mycock, Louise. 2006. *The Typology of Constituent Questions: A Lexical Functional Grammar analysis of 'wh'-questions*. Ph. D.thesis, University of Manchester.
- Næss, Åshild. 2004. What markedness marks: the markedness problem with direct objects. *Lingua* 114, 1186–1212.
- Næss, Åshild. 2007. *Prototypical Transitivity*. *Typological Studies in Language*, No. 72, John Benjamins Publishing Company.
- Nazareth, Amlsom Kifle. 2007. Differential Object Marking and Topicality in Tigrinya. In Miriam Butt and Tracy Holloway King (eds.), *Proceedings of the LFG'07 Conference*, page 5–25, Stanford, CA: CSLI Publications.
- Nazareth, Amlsom Kifle. 2008. Object Asymmetry Properties in Tigrinya. In Gard B Jensen, Øystein Heggelund, Margrete Dyvik Cardona, Stephanie Wold and Anders Didriksen (eds.), *Linguistics in the Making: Selected Papers from the*

- Second Scandinavian PhD Conference in Linguistics and Philology in Bergen, June 4--6, 2007, Oslo: Novus.
- Ngonyani, Deo. 1998. Towards a Typology of Applicatives in Bantu. In Ian Maddieson and Tom Hinnebusch (eds.), *Language History and Linguistic Description in Africa*, page 249–258, Trenton, NJ: African World Press.
- Ngonyani, Deo and Githinji, Peter. 2006. The asymmetrical nature of Bantu applicative constructions. *Lingua* 116, 31–63.
- Nichols, Johanna. 1986. Head-Marking and Dependent-Marking Grammar. *Language* 62(1), 56–119.
- Nikolaeva, Irina. 2001. Secondary topic as a relation in information structure. *Linguistics* 39, 1–49.
- Nordlinger, Rachel. 1998. *A Grammar of Wambaya, Northern Territory (Australia)*. Canberra: Pacific Linguistics.
- O'Connor, Robert. 2006. *Information Structure in Lexical Functional Grammar: The Discourse-Prosody Correspondence*. Ph. D.thesis, University of Manchester.
- O'Herin, Brian. 2001. Abaza Applicatives. *Language* 77(1), 477–493.
- Onishi, Masayuki. 2000. Transitivity and valency-changing derivations in Motuna. In R. M. W. Dixon and Alexandra Y. Aikhenvald (eds.), *Changing Valency: Case Studies in Transitivity*, page 115–143, Cambridge University Press.
- Palmer, Frank R. 1955. The Broken Plurals of Tigrinya. *Bulletin of the School of Oriental and African Studies, University of London* 17(3), 548–566.
- Palmer, Frank R. 1962. Relative Clauses in Tigrinya. *Journal of Semitic Studies* 7(1), 36–43.
- Payne, Doris L. 1985. Degrees of Inherent Transitivity in Yagua Verbs. *International Journal of American Linguistics* 51(1), 19–37.
- Perlmutter, David. 1978. Impersonal Passives and the Unaccusativity Hypothesis. In *Proceedings of the Fourth Annual Meeting of the Berkeley Linguistics Society*, Berkeley, California: University of California at Berkeley.
- Perlmutter, David and Postal, Paul. 1983. Some preposed Laws and Basic Cause Structures. In David Perlmutter (ed.), *Studies in Relational Grammar*, 1, page 81–128, Chicago: University of Chicago Press.
- Perlmutter, David M. and Postal, Paul. 1974. *Lectures on Relational Grammar*. In *Summer Linguistic Institute of the Linguistic Society of America*, Amherst.
- Perlmutter, David M. and Postal, Paul. 1977. Toward a Universal Characterization of Passivization. In *Proceedings of the Third Annual Meeting of the Berkeley Linguistics Society*.

- Perlmutter, David M. and Postal, Paul. 1983. Toward a Universal Characterization of Passivization. In M. David Perlmutter (ed.), *Studies in Relational Grammar*, volume 1, page 3–29, The University of Chicago Press.
- Pesetsky, David. 1995. *Zero Syntax: Experiencers and Cascades*. Cambridge, Massachusetts: The MIT Press.
- Peterson, David. 1999. *Discourse-functional, Historical, and Typological Aspects of Applicative Constructions*. Ph.D.thesis, University of California, Berkeley, California.
- Peterson, David. 2007. *Applicative Constructions*. Oxford: Oxford University Press.
- Polinsky, Maria. 1995. Double Objects in Causatives. *Studies in Languages* 19(1), 129–221.
- Polinsky, Maria. 2005. Applicative Constructions. In Martin Haspelmath, Matthew S. Dryer, David Gil and Bernard Comrie (eds.), *The World Atlas of Language Structures (WALS)*, page 442–445, Oxford University Press.
- Postal, Paul. 1977. Antipassive in French. In *Proceedings of the Seventh Annual Meeting of the North Eastern Linguistics Society*, page 273–313, Massachusetts Institute of Technology.
- Raz, Shlomo. 1980. Tigre Syntax and Semitic Ethiopian. *Bulletin of the School of Oriental and African Studies, University of London* 43(2), 235–250.
- Reid, Nicholas. 2000. Complex verb collections in Ngan'gityemerri: A non-derivational strategy for encoding valency alternations. In R. M. W. Dixon and Alexandra Y. Aikhenvald (eds.), *Changing Valency: Case Studies in Transitivity*, page 333–359, Cambridge, UK: Cambridge University Press.
- Rosen, Carol G. 1984. The interface between semantic rules and initial grammatical relations. In David M. Perlmutter and Carol G. Rosen (eds.), *Studies in Relational Grammar*, volume 2, page 38–77, Chicago: The University of Chicago Press.
- Rude, Noel. 1986. Topicality, Transitivity, and The Direct Object in Nez Perce. *International Journal of American Linguistics* 52(2), 124–153.
- Sadler, Louisa. 1997. Clitics and the Structure-Function Mapping. In Miriam Butt and Tracy Holloway King (eds.), *Proceedings of the LFG'97 Conference Conference*, Stanford, CA: CSLI publications.
- Sadler, Louisa. 1998. Welsh NPs without Head Movement. In Miriam Butt and Tracy Holloway King (eds.), *Proceedings of the LFG98 Conference*, Stanford, CA: CSLI publications.
- Sadler, Louisa and Spencer, Arnold. 1998. Morphology and Argument Structure. In

- Andrew Spencer and Arnold M. Zwicky (eds.), *The Handbook of Morphology*, page 206–236, Oxford, UK: Blackwell.
- Sells, Peter. 1985. *Lectures on Contemporary Syntactic Theories: An Introduction to Government-Binding Theory, Generalized Phrase Structure Grammar and Lexical-Functional Grammar*. CSLI Lecture Notes, Stanford, CA: CSLI Publications.
- Siewierska, Anna. 1984. *The passive: A comparative linguistic analysis*. Croom Helm Linguistics Series, London: Croom Helm.
- Silverstein, Michael. 1976. Hierarchy of Features and Ergativity. In R.M.W. Dixon (ed.), *Grammatical Categories in Australian Languages*, page 112–171, Canberra: Australian Institute of Aboriginal Studies.
- Silverstein, Michael. 1981. Case Marking and the Nature of Language. *Australian Journal of Linguistics* 1, 227–244.
- Spencer, Andrew. 2005. Case in Hindi. In Miriam Butt and Tracy Holloway King (eds.), *Proceedings of the LFG05 Conference*, CSLI Publications.
- Stapleton, W. H. 1903. *Comparative Handbook of Congo Languages*. Yakusu, Stanley Falls, Congo Independent State: Hannah Wade Printing Press.
- Tesfay, Yohannes Tewolde. 2002. *A Modern Grammar of Tigrinya*. Roma, Italy: U. Detti.
- Thomason, Sarah Grey. 2001. Contact-Induced Typological Change. In Martin Haspelmath, Ekkehard Koenig, Wulf Oesterreicher and Wolfgang Raible (eds.), *Language typology and language universals: An international handbook*, page 1640–1648, Berlin and New York: Walter de Gruyter.
- Tosco, Mauro. 2000. Is There an “an Ethiopian Language Area”? *Anthropological Linguistics* 42(3), 329–365.
- Traski, R.L. 1999. *Key concepts in Language and Linguistics*. London and New York: Routledge.
- Trithart, M. 1976. *Relational Grammar and Chichewa Subjectivization Rules*. Masters Thesis, UCLA, Los Angeles, CA.
- Trithart, M. 1983. *The Applied Affix and Transitivity: A Historical Study in Bantu*. Ph.D.thesis, UCLA, Los Angeles, CA.
- Vallduví, Enric. 1992. *The Informational Component*. New York: Garland.
- Van Valin, Robert D. 1992. An overview of ergative phenomena and their implications for language acquisition. In D. I. Slobin (ed.), *The crosslinguistic study of language acquisition*, volume 3, page 15–39, Hillsdale, NJ: Lawrence Erlbaum.
- Van Valin, Robert D. 2001. *An Introduction to Syntax*. Cambridge, UK: Cambridge

- University Press.
- Vitale, Anthony J. 1981. *Swahili Syntax*. Dordrecht: Foris.
- Voigt, Rainer. 2009. Tigrinya, an “African-Semitic” language. *Folia Linguistica Historica* 30, 391–400.
- Weldu, Michael Weldeyesus. 2004. Case marking systems in two Ethiopian Semitic languages. *Colorado Research in Linguistics* 17(1), 1–16.
- Zaenen, Annie. 1993. Unaccusativity in Dutch: Integrating Syntax and Lexical Semantics. In J. Pustejovsky (ed.), *Semantics and the Lexicon*, page 129–161, London: Kluwer.
- Zaenen, Annie and Engdahl, Elisabet. 1994. Descriptive and Theoretical Syntax in the Lexicon. In Beryl Atkins and Antonio Zampolli (eds.), *Computational Approaches to the Lexicon*, New York: Oxford University Press.

