



MASTER'S THESIS IN THEORETICAL PHYSICS AND ENERGY PHYSICS

DEPARTMENT OF PHYSICS AND TECHNOLOGY

UNIVERSITY OF BERGEN

Hydroelectric Power in Present and Future Energy Systems

Author:
Tjalve Magnusson SVENDSEN

Supervisor:
Professor Jan S. VAAGEN

June 3, 2013

Acknowledgements

First of all, I wish to express my sincere gratitude to my supervisor, Professor Jan S. Vaagen, for his professional guidance, and for numerous interesting discussions on energy related topics the past two years. His knowledge and enthusiasm has given me motivation to finish this dissertation.

I am also very grateful to PhD student Jesper Tveit for helpful discussions, as well as for giving me lots of good advice along the way.

I would like to thank BKK for providing financial support to this work, and *Tidal Sails* for welcoming us in Haugesund and letting me write about their activities. I would also like to thank Professor Jarle Berntsen, Head of the Department of Mathematics at the University of Bergen, for insightful conversations regarding tidal energy.

Thank you Steffen Mæland, Rune Hauge, Kine Johnsen, Christer van der Meeren, Tonje Vedde Fiskerstrand, Eivind Mosland, Julia Skorpen Dahl, Daniel Aadnevik, Tordis Dahle, Agnethe Seim Olsen, Mayasa Rashed, and all my other friends at the Physics Department, for all the great moments we've had together over the past couple of years.

I would like to express my gratitude towards my family, who always gives me support and encouragement. Special thanks to my parents for proofreading of the thesis, and for always being there for me.

Last but not least, I would like to thank the love of my life and best friend Isabel for always giving me unconditional support and care.

Tjalve M. Svendsen

Bergen, June 2013

Abstract

To be able to understand the dynamics of energy systems, the interplay between a variety of factors affecting them has to be addressed. In this thesis, we look at issues like climate change, energy policy, power transmission, energy storage and energy technology, to discuss the role of hydroelectric power in present and future energy systems. A model predicting future carbon emissions and temperature change has been developed, showing the dependence of possible climate change abatement on how *soon* and how *fast* we can reduce global emissions, underlining the importance of switching from non-renewable to renewable energy sources in the future. The increasing importance of *stable* and *predictable* renewables is highlighted, arguing that hydroelectric power - with its stability, predictability and also *flexibility* - could have a changed role in future energy systems, being used more extensively for balancing purposes and energy storage. Norway, having large hydropower- and hydro storage capacity, could thus play an important part as a stabilizing factor in a Nordic-, and also, to an increasing yet limited degree, in a European power system.

Another fully predictable and sustainable power source being addressed in this thesis, is tidal power, which could experience commercial breakthrough in future energy systems. In addition to providing an overview of tidal energy conversion technologies, discussions regarding different methods for estimating tidal energy resource potentials are presented. We also look at Norwegian tidal energy resource estimates, as well as providing some self-produced, "back-of-envelope" calculations, estimating the total incoming tidal power to the Norwegian shore to be in the order of 30 GW, about the same as the present hydropower capacity in Norway. It is further suggested that 6.5 TWh could be extracted from this, annually. Although being very rough estimates, they support the view that new thorough studies of the Norwegian tidal resource potential should be conducted.

Units and Symbols

Energy and Power

The SI-unit of *energy* is Joule, J, where one Joule is the *work* done in applying a force of one Newton through a distance of one meter;

$$1\text{J} = 1\text{Nm} = 1\text{kg m}^2/\text{s}^2.$$

Power is defined as the rate of which energy is being used, or in other words, work done per unit time, with SI-unit W (Watt), so that

$$1\text{W} = 1\text{J/s}.$$

Electric energy is often given with the unit Watt-hour (Wh);

$$1\text{Wh} = 1\text{J/s} \cdot h = 3600\text{J}.$$

Prefixes

name	symbol	value
femto	<i>f</i>	10^{-15}
pico	<i>p</i>	10^{-12}
nano	<i>n</i>	10^{-9}
micro	μ	10^{-6}
milli	<i>m</i>	10^{-3}
centi	<i>c</i>	10^{-2}
deci	<i>d</i>	10^{-1}
deca	<i>da</i>	10^1
hecto	<i>h</i>	10^2
kilo	<i>k</i>	10^3
mega	<i>M</i>	10^6
giga	<i>G</i>	10^9
tera	<i>T</i>	10^{12}
peta	<i>P</i>	10^{15}

Contents

Acknowledgements	i
Abstract	iii
Prefixes	v
Table of Contents	ix
List of Figures	xii
Introduction	xiii
Chapter Guide	xv
1 Climate Change and Mitigation	1
1.1 Global Carbon Emission Model and Temperature Change . . .	1
1.1.1 Different models for carbon emissions	2
1.1.2 Closing door on climate targets	9
1.1.3 Comments	13
1.1.4 Mitigation	14
2 Theory and Technology of Hydropower and Energy Storage	15
2.1 Potential energy	15
2.2 Basic Equations for a Fluid Flow	15
2.2.1 The Navier-Stokes Equations.	15
2.2.2 The Mechanical Energy Equation	16
2.2.3 Thermal Energy Equation	17
2.2.4 The Bernoulli Equation	17
2.3 Turbines	19
2.3.1 Pelton turbine	20
2.3.2 Francis turbine	20
2.3.3 Propeller- and Kaplan Turbine	21
2.3.4 Cross flow turbine	22
2.4 Pumps and Reversible Turbines	22
2.4.1 Positive-Displacement Pumps	24
2.4.2 Centrifugal Pumps	24
2.4.3 Reversible Francis turbine	25
2.4.4 Variable speed pump-turbine technology	27

2.5	Design Challenges and Possible Improvements	28
2.5.1	Cavitation	28
2.5.2	Multiphase flows	29
2.5.3	Research and development	29
2.6	Energy Storage Technologies	30
2.6.1	Pumped Hydro Storage	30
2.6.2	Compressed Air	31
2.6.3	Thermal Storage	32
2.6.4	Flywheels	32
2.6.5	Hydrogen	33
2.6.6	Batteries	33
3	Hydroelectric Power	35
3.1	A Historical View and Status of Hydropower	36
3.1.1	Global development and capacity	36
3.2	Development of Hydropower in Norway	37
3.3	Technical Potential of Hydropower	40
3.3.1	Global hydropower potential	40
3.3.2	Norwegian hydropower potential	41
3.3.3	Upgrades and expansions of existing sites	42
3.4	Classification of Hydropower Schemes	43
3.4.1	Classification by head and size	43
3.4.2	Run-of-river type hydropower	44
3.4.3	Reservoir type hydropower	44
3.5	Pumped-Storage Hydropower and Need for Grid-balance	45
3.5.1	Power fluctuations and stability	45
3.5.2	Need for energy storage in future renewable energy systems	47
3.5.3	Status and global development of pumped-storage hydropower	50
3.5.4	Pumped hydro in Norway	50
3.6	Impacts of Hydropower Development	52
3.6.1	Environmental impacts	52
3.6.2	Socioeconomic impacts	54
3.6.3	Increasing resistance to Norwegian hydropower development in the 60s, 70s and 80s	55
3.6.4	"Monstrous masts"	56
3.6.5	The Three Gorges	56
3.7	Significance of Water as Resource	57
3.7.1	Hydropower in the Himalayas	58
3.7.2	International society's role	59

3.7.3	Further development	60
4	Tidal Energy	63
4.1	Status of Tidal Power	63
4.2	Why we have Tides	64
4.3	Estimates of Available Tidal Power and Technical Potential	67
4.3.1	Norwegian tidal resource	69
4.3.2	Some "back-of-envelope" tidal power calculations	72
4.4	Tidal Power Technologies	74
4.4.1	Barrages	74
4.4.2	Tidal lagoons	75
4.4.3	Tidal currents	76
4.4.4	Dynamic tidal power	78
4.5	Tidal Sails	79
5	Future Energy Systems and Role of Hydroelectric Power	83
5.1	Political Framework	83
5.1.1	EU politics	83
5.1.2	Emissions trading system and carbon price	84
5.1.3	Green certificates	85
5.2	Power Transmission	88
5.2.1	Power exchange and inter-connectors	88
5.3	Norway as Green Battery for Europe	90
5.3.1	Potential size of the battery	90
5.3.2	Stable power system	91
5.3.3	Possible consequences	92
5.3.4	Alternative methods for balancing fluctuations	92
5.4	Can we Mitigate?	94
5.4.1	How Norway can contribute	96
6	Summary and Outlook	99
	Appendices	101
A	Source Code	103
A.1	Emission Rate Functions and Annual Emission Functions	103
A.2	Required Reduction rates as function of starting year of GMS	105
A.3	Temperature change as function of years before peak emissions	109

List of Figures

1.1	Emissions reduction rate functions 1	4
1.2	Annual Emissions Functions 1	4
1.3	Emissions Reduction Rate Functions 2	5
1.4	Annual Emissions Functions 2	5
1.5	Emissions Reduction Rate Functions 3	6
1.6	Annual Emissions Functions 3	6
1.7	Closing Door on 2 Degrees Target	10
1.8	Closing Door on 2.5 Degrees Target	11
1.9	Closing Door on 3 Degrees Target	11
1.10	Temperature Change as Function of Years before Peak-emissions 1	12
1.11	Temperature Change as Function of Years before Peak-emissions 2	13
2.1	Schematic Francis Turbine	21
2.2	Three Gorges Francis Runner	22
2.3	Turbine Efficiencies	23
2.4	Schematic Ideal Centrifugal Pump	26
2.5	Schematic Francis Runner of Reversible Pump-turbine	27
2.6	Pumped-storage Hydropower	31
3.1	Hydropower Generation by Region	37
3.2	Hydropower Generation by Country	38
3.3	Hydropower Installed Capacity by Country	38
3.4	Hydropower Capacity in Norway 1974 - 2010	40
3.5	Hydropower Technical Potential by Region	41
3.6	Norwegian Hydropower Potential	42
3.7	Norwegian Power Consumption Curve on a Typical Day	46
3.8	Norwegian Power Consumption Curve during a Typical Week	46
3.9	Norwegian Power Consumption Curve 2010-2012	47
3.10	Norwegian Power Consumption and Generation during a Typical Week	48

3.11	Norwegian Power Import/Export	48
3.12	Installed Pumped-storage Hydropower by Country	51
4.1	Model of the Earth Covered Uniformly by Ocean	65
4.2	Gravitational Effect from the Moon	65
4.3	World Map of Tidal Amplitudes	66
4.4	Oceanic Landscape around the Coast of Norway	70
4.5	Sea Map of Vestfjorden	71
4.6	Dynamic Tidal Power	78
4.7	Tidal Sails 1	79
4.8	Tidal Sails 2	82
4.9	Tidal Sails 3	82
5.1	Electricity as Energy Carrier	89
5.2	Mitigation Rate Function	97
5.3	Mitigation Emissions Function	97

Introduction

To make hydroelectric power you basically need two things - altitude and rainfall. Let's say the average annual rainfall in Norway is about 1200 mm per year, and that the average altitude, h , at which the rain hits the ground is say 500 m. The density of the rain is $\rho = 1000 \text{ kg/m}^3$, and the gravitational constant is $g = 10 \text{ m/s}^2$. The mass of water raining on a square meter surface per year is then, approximately,

$$m = \rho * 1.2\text{m}/\text{yr} = 1200\text{kg}/\text{m}^2/\text{yr}.$$

The potential energy per year is then

$$E_p = mgh \simeq 6 * 10^6 \text{J}/\text{m}^2/\text{yr},$$

which gives an average power per square meter of¹

$$P = 6 * 10^6 \text{Ws}/\text{m}^2/\text{yr} \simeq 0.2\text{W}/\text{m}^2.$$

Given that the land area of Norway is about 350 000 km², this gives an average rainpower of

$$\begin{aligned} P &= 70\text{GW} \\ &\simeq 600\text{TWh}/\text{yr} \\ &\simeq 300\text{kWh}/\text{day}/\text{person}. \end{aligned}$$

The total consumption of electricity in Norway is about 120 TWh/yr (about 60 kWh/day/person on average). Clearly Norway is a country blessed with hydropower resources.

The extreme population growth the world has experienced the last decade or two, with possible consequence of rapid climate change, is the single greatest challenge mankind is facing today. To provide sufficient energy and also to

¹There are $60 * 60 * 24 * 365 \sim 30000000$ seconds per year

reduce carbon emissions and obtain a sustainable future, major changes have to be made. One of the measures that could have the most impact is to go from the fossil based energy systems we have today, to systems based on renewables. This is certainly not done over night.

Future energy systems with large shares of intermittent renewables like wind- and solar power, will have a great need for steady and predictable power sources to secure stable power systems. In addition to being steady and predictable, hydropower is also very *flexible*, as a hydropower plant can switch on and off its power generation in a matter of seconds. The possibility of using hydropower reservoirs as pumped-storage hydropower schemes adds to this flexibility. Therefore it is believed that the value of hydropower as a resource could increase in the future, having perhaps a different role than in today's system. In this thesis, the status of hydropower in today's energy systems will be given, as well as discussions of further development of hydropower and water usage in future energy systems.

Traditional hydroelectric power is not the only source of power from water in motion. *Tidal energy* also represents a steady, predictable energy source, which is fully sustainable as long as we have oceans and the moon. Although tidal stream energy converters have not yet succeeded in being commercialized, and tidal barrages only represent a negligible share of the global power generation, tidal power has significant potential and could play an important part in the future renewable energy mix.

Wind-driven ocean wave power is another source of power from water in motion that could experience a commercial breakthrough if renewables are to become more profitable. Fugro OCEANOR has estimated that incoming wave power density entering the shore of Norway is on average 30-40 kW/m, and a widely used number is that the raw incoming energy per year is 400 TWh [131, 93, 107]. Assuming that 10% of the Norwegian shore could be exploited with 20% efficiency, this would give 8 TWh annually. The main challenge regarding surface wave energy is that the wave energy converters have to be dimensioned to withstand storms and extreme-waves, something *Kværner* experienced with their wave energy test site at Øygarden outside Bergen in Norway. The site was constructed in 1985 and was working fine until it was crushed by powerful waves in a storm in 1988. Since then, little or nothing has been done on wave energy in Norway. Another drawback of wind-driven wave power is that it is weather dependent and unsteady, as it relies on the wind. For that reason, wave energy will not be covered in this thesis.

To be able to discuss energy systems and climate change mitigation, it is important to have a broad understanding of the various components that affect these considerations. Power *transmission* and energy *storage* are topics that will be addressed (without going into technical details), as a future energy system is expected to have electricity as a more dominant energy carrier, and since increased fluctuations in the power net due to intermittent sources is a challenge that has to be met. In addition, carbon emissions, resource availability, energy policy and -economics set the premises for development and possible sustainability, and need therefore also to be considered.

Chapter guide

The first chapter gives a background for the motivations of switching from a fossil energy system to a system based on renewables, in terms of climate change and possible mitigation strategies. A model for predicting future carbon emissions and temperature change is presented.

Chapter 2 is a technical chapter containing theory and technology of fluid flow, hydropower and energy storage.

Chapter 3 contains historical development of hydropower globally, and in Norway, up until today. It presents an overview of present capacity in different regions and estimates of technical potential. Different types of hydropower schemes are described and different environmental and socioeconomic issues are addressed. At the end of the chapter, the significance of water as natural resource and possible conflicts between different water uses is discussed.

Chapter 4 presents status of tidal power and different techniques for tidal energy conversion. It includes a discussion regarding estimates of tidal resources, and includes some "back-of-envelope" estimates of the Norwegian tidal resource potential. At the end of the chapter, a presentation of a Norwegian tidal power company, *Tidal Sails*, is given.

Chapter 5 considers a future energy system in a wider perspective. An overview of energy legislation and economic conditions is given, as well as discussions regarding the idea of Norwegian hydropower as a "Green Battery" for Europe. Some thoughts about how Norway best can contribute to the energy transition from fossils to renewables are presented at the end.

The last chapter, Chapter 6, contains a summery and outlook.

Chapter 1

Climate Change and Mitigation

1.1 Global Carbon Emission Model and Temperature Change

A number of recent studies have found a strong link between global warming and cumulative carbon emissions from the start of the industrial revolution. Allen et al. [6] compare a set of different climate models and find that this link seems to be linear, i.e. peak in temperature change since 1990 levels is proportional with the cumulative emissions. The proportionality factor, which they call β , they calculate to most likely have a value of $2^\circ/\text{TtC}$ (two degrees change per trillion (Tera) tonnes of carbon emitted), although this value is associated with considerable uncertainties. Hence, using this linearity, we can estimate global (possibly mainly human-induced) temperature change if we can model the cumulative carbon emissions, C_∞ ;

$$\Delta T = \beta \cdot C_\infty \quad (1.1)$$

To estimate the cumulative emissions since pre-industrial time and further on, one has to create reasonable emission models describing how the annual global carbon emissions develop as a function of time, $E(t)$. The cumulative emissions can then easily be calculated by integrating this function from the start of the industrial revolution to infinity;

$$C_\infty = \int E(t)dt \quad (1.2)$$

The shape of the function $E(t)$ (and thus also the value of C_∞ and temperature change) in the following years will depend on factors like population growth, climate- and energy policy, development in technology, as well as people's willingness to mitigate towards a low-emission society.

1.1.1 Different models for carbon emissions

Perhaps the most well-known models for carbon emissions are those presented by the Intergovernmental Panel on Climate Change (IPCC). In 1992, six scenarios, the so-called "IS92", were published in a supplementary report to the IPCC Second Assessment. In 2000, the panel released a Special Report on Emissions Scenarios (SRES) consisting of 40 different future emissions scenarios for the period between 1990 and 2100. The scenarios take into account the most important *scenario driving forces* (which they find are population projections, economic development, and structural and technological change) and how they affect the emission patterns. The 40 scenarios are then arranged in four "families" of scenarios, arising from alternative storylines that represent possible futures with different combinations of driving forces. The models do not, however, take into account a possible conduction of any measures to limit greenhouse gas (GHG) emissions. Total cumulative CO₂ emissions from the SRES scenarios fall into the range from 773 to 2538 gigatonnes of carbon (GtC) with a median of 1509 GtC [84].

An established climate target in today's climate- and energy debate is the two degrees target, global temperature change shall not exceed 2 degrees Celsius compared to 1990 levels. The SRES scenarios together with equation 1.1 indicate that some sort of measures to reduce emissions will have to be implemented in order to reach these targets. Although attempts have been made, global agreements with strength to constrain carbon emissions sufficiently have not succeeded. Measurements indicate an exponential growth in annual carbon emissions with a constant fractional increase of 1.8 percent per year.

In an article [120] printed in *Science Magazine* January 2013, Thomas F. Stocker presents a simplified model of global annual carbon emissions, which assumes continuing exponential growth with a constant rate r ($=0.018$) until a year t_1 , where a global mitigation scheme (GMS) sets in. After this year global carbon emissions will be exponentially reduced at a constant rate s ;

$$\frac{1}{E} \frac{dE}{dt} = \begin{cases} r & \text{if } t_0 < t < t_1 \\ -s & \text{if } t \geq t_1 \end{cases} \quad (1.3)$$

$$\Rightarrow E_{Stocker}(t) = \begin{cases} E_0 e^{r(t-t_0)} & \text{if } t_0 < t < t_1 \\ E_0 e^{r(t_1-t_0)} e^{-s(t-t_1)} & \text{if } t \geq t_1 \end{cases} \quad (1.4)$$

where E_0 is the measured annual global emissions in the year t_0 . Using eq. 1.2 and that C_0 is the cumulative emissions from the start of the industrial revolution up until year t_0 , one can thus find a formula for C_∞ by integration;

$$\begin{aligned}
C_{\infty,Stocker} &= C_0 + \int_{t_0}^{\infty} E_{Stocker}(t) dt \\
&= C_0 + \int_{t_0}^{t_1} e^{r(t-t_0)} dt + \int_{t_1}^{\infty} E_0 e^{r(t_1-t_0)} e^{-s(t-t_1)} dt
\end{aligned} \tag{1.5}$$

which can be solved analytically:

$$C_{\infty,Stocker} = C_0 + E_0 \left(\frac{1}{r} + \frac{1}{s} \right) e^{r(t_1-t_0)} - \frac{E_0}{r} \tag{1.6}$$

The values for annual and cumulative emissions at the year $t_0 = 2009$ have been set¹ to be $E_0 = 9.3$ GtC/year and $C_0 = 530$ GtC, respectively.

Using this model Stocker relates the starting year, t_1 , of a global mitigation scheme (for example a globally binding agreement on climate policy) to the necessary fractional reduction rate s if we are to stay below certain temperature changes (i.e. 2 degrees, 2.5 degrees, 3, 4..).

The Stocker emission model represented by eq.1.4 is illustrated by the blue lines in figs. 1.2, 1.4 and 1.6.

¹Values are taken from R. J. Andres et al, *Biogeosciences*(2012) and are held constant in all further calculations.

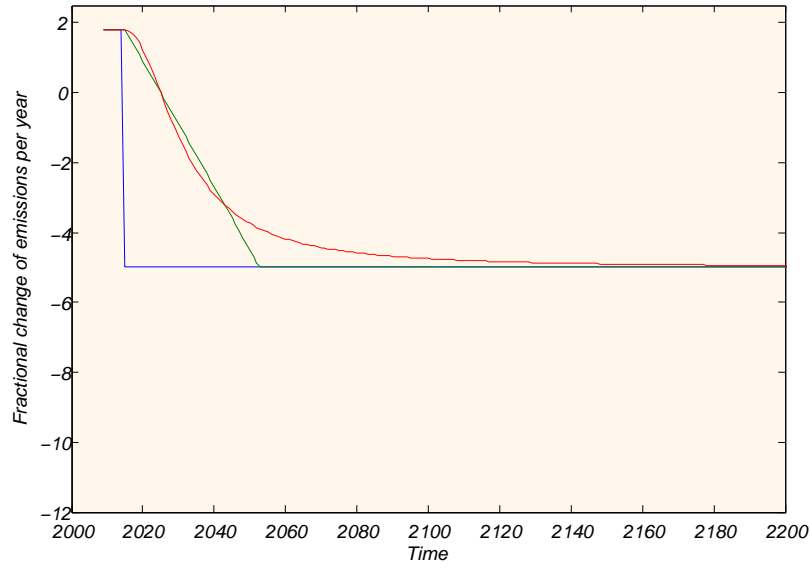

Figure 1.1: The fractional rate of change as function of time, $m(t)$, for the different emission models. Blue line shows Stocker's model with a sudden change from r to $-s$, green line shows Allan's linear transition, while red curve approaches $-s$ as time evolves. Starting year of GMS $t_1 = 2015$, peak-emission year after 10 years and $s = 5$ percent reduction per year.

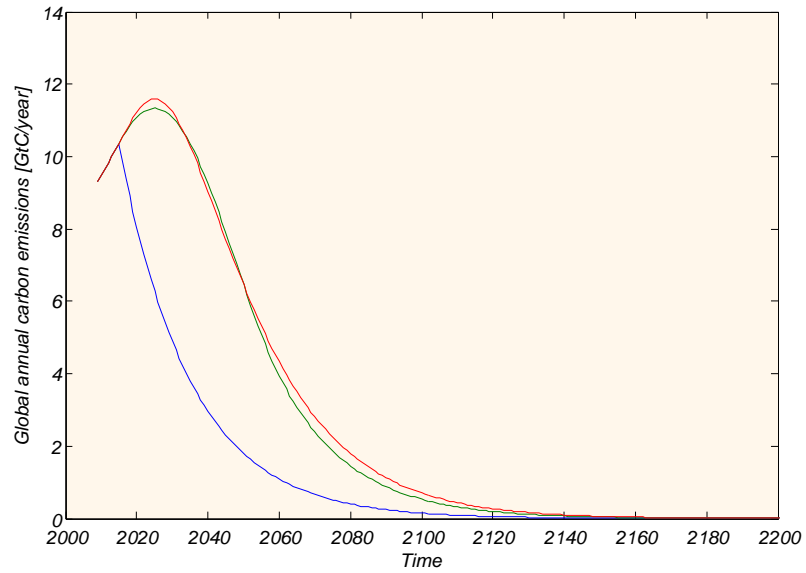

Figure 1.2: Different emission models plotted with $t_1 = 2015$, peak-emission year after 10 years and $s = 5$ percent per year. Temperature increase for Blue, green and red curves are 1.6, 2.1 and 2.2 degrees respectively.

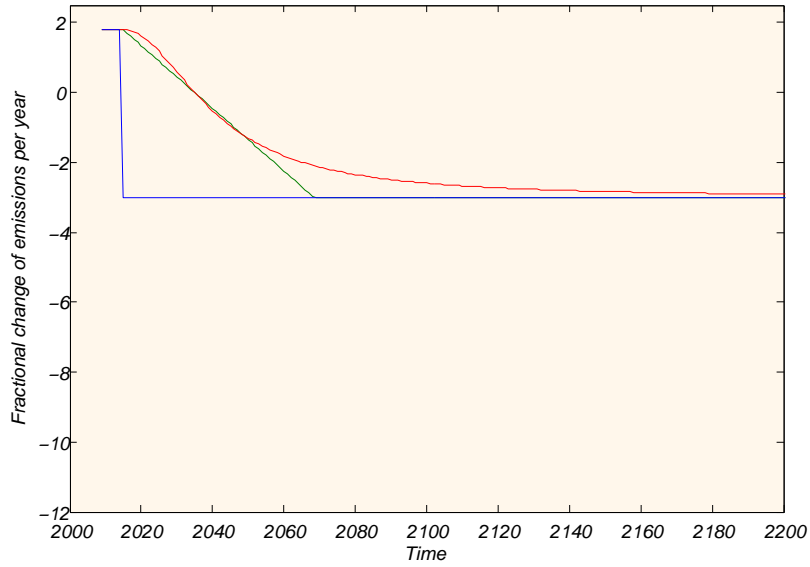

Figure 1.3: Fractional reduction rate functions $m(t)$ with $t_1 = 2015$, peak-emission year after 20 years and $s = 3$ percent per year.

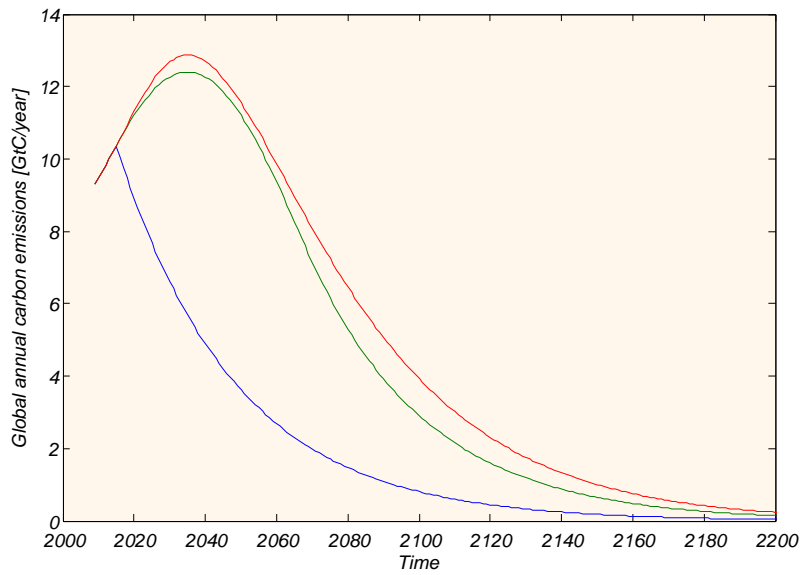

Figure 1.4: Corresponding emission curves with temperature increase for blue, green and red curves being 1.9, 2.9 and 3.1 degrees respectively.

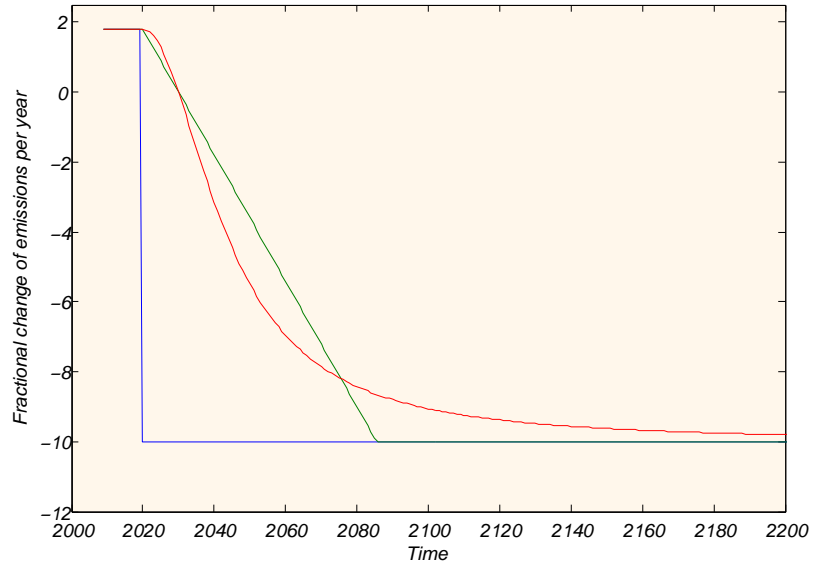

Figure 1.5: Different reduction rate functions $m(t)$ with $t_1 = 2020$, peak-emission year after 10 years and $s = 10$ percent per year.

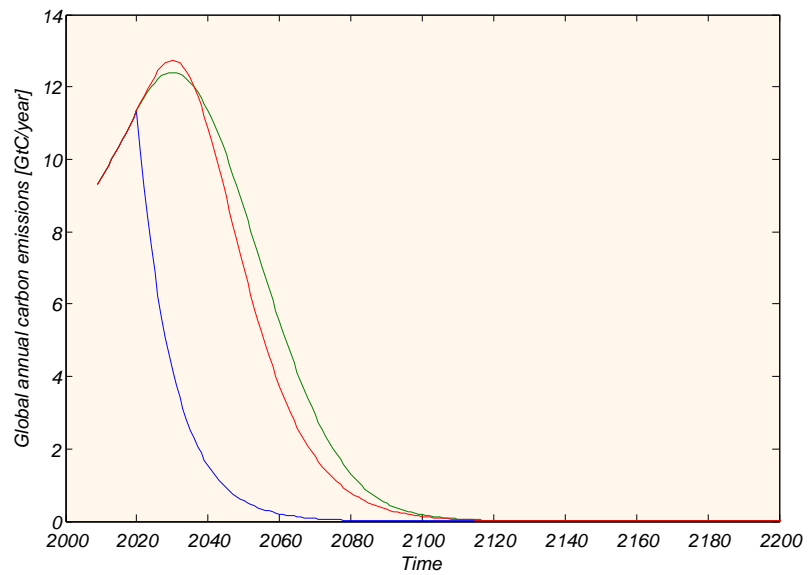

Figure 1.6: Corresponding emission curves with temperature increase for blue, green and red curves being 1.5, 2.3 and 2.1 degrees respectively.

It is not difficult, however, to imagine that this sort of sharp peak in global carbon emissions is very unlikely or even impossible to obtain with the existing global governance. This sort of peak would, if anything, have had to be caused by some sort of global catastrophe. A more realistic emission scenario would be to, after the starting year of global mitigation scheme, gradually go from the steady fractional increase to reduction, as a function of time, $m(t)$;

$$\frac{1}{E} \frac{dE}{dt} = m(t) \quad (1.7)$$

One possible scenario (used by Allan et al.) is that the transition from r to $-s$ is linear, i.e. after year t_1 (starting year of global mitigation scheme) $m(t)$ reduces linearly and passing 0 after t_2 years (year of peak emissions) before reaching a constant rate of $-s$ after t_3 years;

$$\frac{1}{E} \frac{dE}{dt} = m_{Allan}(t) = \begin{cases} r & \text{if } t_0 \leq t < t_1 \\ r - a(t - t_1) & \text{if } t_1 \leq t < t_3 \\ -s & \text{if } t \geq t_3 \end{cases} \quad (1.8)$$

The slope a of this linear change can further be expressed by the peak emission year t_2 when $r - a(t_2 - t_1) = 0$, giving

$$\frac{1}{E} \frac{dE}{dt} = m_{Allan}(t) = \begin{cases} r & \text{if } t_0 \leq t < t_1 \\ r(1 - \frac{t-t_1}{t_2-t_1}) & \text{if } t_1 \leq t < t_3 \\ -s & \text{if } t \geq t_3 \end{cases} \quad (1.9)$$

This is, as eq. 1.3, a separable differential equation which can be integrated to find the annual global carbon emissions as a function of time;

$$E_{Allan}(t) = \begin{cases} E_0 e^{r(t-t_0)} & \text{if } t_0 < t < t_1 \\ E_0 e^{r(t_1-t_0)} e^{r(1 - \frac{t-t_1}{t_2-t_1})(t-t_1)} & \text{if } t_1 \leq t < t_3 \\ E_0 e^{r(t_1-t_0)} e^{r(1 - \frac{t_3-t_1}{t_2-t_1})(t-t_1)} e^{-s(t-t_3)} & \text{if } t \geq t_3 \end{cases} \quad (1.10)$$

Notice now the quadratic time correction to the exponent in $t_1 \leq t < t_3$.

As illustrated by the green plots in figs. 1.2, 1.4 and 1.6 the annual emissions follow a path which seems intuitively more realistic with a smooth transition from the exponential growth to the exponential decay.

A perhaps even more realistic scenario might be that $m(t)$ itself is smooth (in the meaning differentiable at all points). In figs. 1.1, 1.3 and 1.5 this is illustrated by the red plots changing smoothly from r , passing 0 after t_2

years, before approaching a steady negative value ($-s$) as time evolves. This type of growth rate can be constructed in the following way:

$$\frac{1}{E} \frac{dE}{dt} = m(t) = \begin{cases} r & \text{if } t_0 < t < t_1 \\ \frac{r+s}{1+b(t-t_1)^2} - s & \text{if } t \geq t_1 \end{cases} \quad (1.11)$$

which, when integrated gives

$$E(t) = \begin{cases} E_0 e^{r(t-t_0)} & \text{if } t_0 < t < t_1 \\ E_0 e^{r(t_1-t_0)} e^{\frac{r+s}{\sqrt{b}} \arctan(\sqrt{b}(t-t_1)) - s(t-t_1)} & \text{if } \geq t_1 \end{cases} \quad (1.12)$$

The factor b , which decides how fast $m(t)$ approaches $-s$ can also in this case be related to the peak year of emissions t_2 as $\frac{r+s}{1+b(t_2-t_1)^2} - s = 0$.

Annual emissions are illustrated as the red curves in figs. 1.2, 1.4 and 1.6. When comparing with the other models we see that Stocker's model differs significantly from the other two which looks quite similar. This is also the case when comparing the different relative rate functions $m(t)$ in figs. 1.1, 1.3 and 1.5.

To calculate the different cumulative emissions we must integrate eqs. 1.10 and 1.12.

$$\begin{aligned} C_{\infty,Allan} &= C_0 + \int_{t_0}^{\infty} E_{Allan}(t) dt \\ &= C_0 + \int_{t_0}^{t_1} e^{r(t-t_0)} dt \\ &\quad + \int_{t_1}^{t_3} E_0 e^{r(t_1-t_0)} e^{r(1-\frac{t-t_1}{2(t_2-t_1)})(t-t_1)} dt \\ &\quad + \int_{t_3}^{\infty} E_0 e^{r(t_1-t_0)} e^{r(1-\frac{t_3-t_1}{2(t_2-t_1)})(t-t_1)} e^{-s(t-t_3)} dt \end{aligned} \quad (1.13)$$

The integral

$$I_{2,Allan} = \int_{t_1}^{t_3} e^{r(1-\frac{t-t_1}{2(t_2-t_1)})(t-t_1)} dt$$

is solved numerically using *Simpson's rule* for estimating integrals. This finally gives

$$C_{\infty,Allan} = C_0 + E_0 \left(\frac{1}{r} + I_{2,Allan} + \frac{1}{s} e^{r(1-\frac{t_3-t_1}{2(t_2-t_1)})(t_3-t_1)} e^{r(t_1-t_0)} - \frac{1}{r} \right) \quad (1.14)$$

In the same way we integrate eq.1.12 to get the cumulative emissions

$$\begin{aligned}
C_\infty &= C_0 + \int_{t_0}^{\infty} E(t)dt \\
&= C_0 + \int_{t_0}^{t_1} e^{r(t-t_0)} dt \\
&\quad + \int_{t_1}^{\infty} E_0 e^{r(t_1-t_0)} e^{\frac{r+s}{\sqrt{b}} \arctan \sqrt{b}(t-t_1) - s(t-t_1)} dt
\end{aligned} \tag{1.15}$$

Where

$$I_2 = \int_{t_1}^{\infty} e^{\frac{r+s}{\sqrt{b}} \arctan \sqrt{b}(t-t_1) - s(t-t_1)} dt$$

also has to be solved numerically using the same technique. This gives

$$C_\infty = C_0 + E_0 \left(\frac{1}{r} + I_2 \right) e^{r(t_1-t_0)} - \frac{E_0}{r} \tag{1.16}$$

Setting different values for t_1 (starting year of global mitigation scheme), t_2 (peak year of emissions) and s (fractional change of annual global carbon emissions in %change/year) we create different emission scenarios giving different peak temperature changes. Three scenarios are presented in figs. 1.1 and 1.2, 1.3 and 1.4, and 1.5 and 1.6. Blue curves represents Stocker's model, green curves Allan's model and red curves our model.

1.1.2 Closing door on climate targets

Using this simple carbon emission formula described by eq. 1.12 we can relate the necessary reduction rates, to the starting year of a global mitigation scheme, if we are to stay below different targets of maximum temperature increases. When increasing the number of years from the start of GMS until the peak of emissions, t_2 , we would expect that higher reduction rates are needed at an earlier stage to stay below levels of maximum temperature increase. In other words, that the closing door on climate targets is approaching faster than previously estimated by Stocker.

In figs. 1.7 (2 degrees target), 1.8 (2.5 degrees target) and 1.9 (3 degrees target) the blue line represents the Stocker emission model, while lines reading from right to left; red, green, black, purple, brown, are estimated with a peak emission year 1, 4, 9, 16, 25 years after the starting year of a global mitigation scheme. Naturally a peak in emissions only one year after GMS follows Stocker's model quite well, while the other lines differs with an increasing amount the later the year of peak-emissions occur. For example we see that with a peak emission year 9 years after the GMS (black line),

using a limit of a fractional reduction of 5% per year, would mean that GMS would have to be initiated in 2013, to achieve the 2 degrees target. For a peak-emission year 16 years after the GMS we see that the 2 degrees target is already unachievable.

The value of s (which has strong impacts on the global economic consequences of emission reductions) needed to satisfy the 2 degrees target is seen to increase exponentially as the starting year of a global mitigation scheme is delayed.

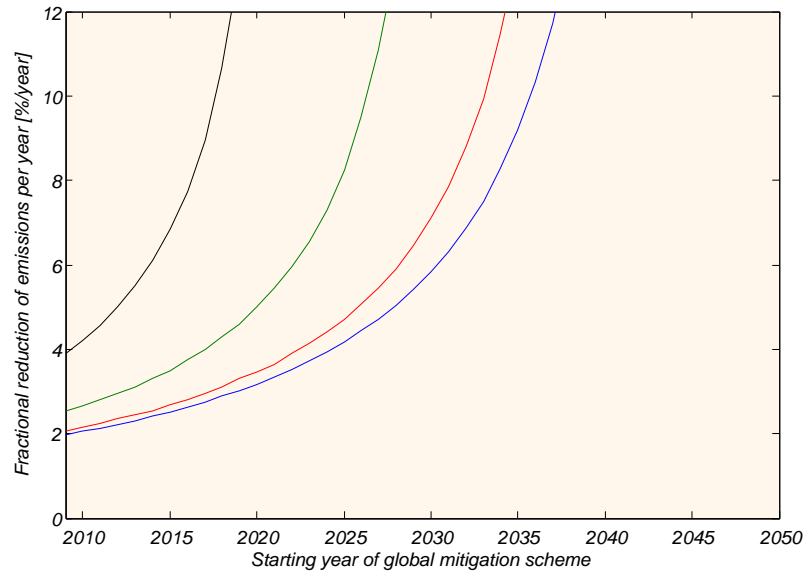

Figure 1.7: *Closing door on 2 degrees target.* The lines show the necessary reduction rate s needed for the different starting year of a GMS, in order to stay beneath two degrees temperature increase. Blue line uses Stocker's emission model, red line indicates peak-emissions after one year, green line after 4 years, black line after 9 years

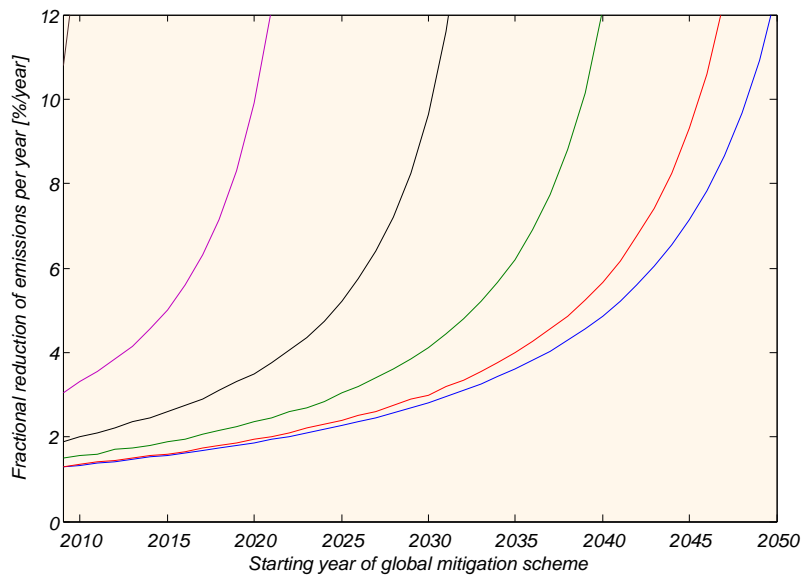

Figure 1.8: *Closing door on 2.5 degrees target.* Blue line uses Stocker's emission model, red line indicates peak-emissions after one year, green line after 4 years, black line after 9 years, purple line after 16 years, brown line after 25 years

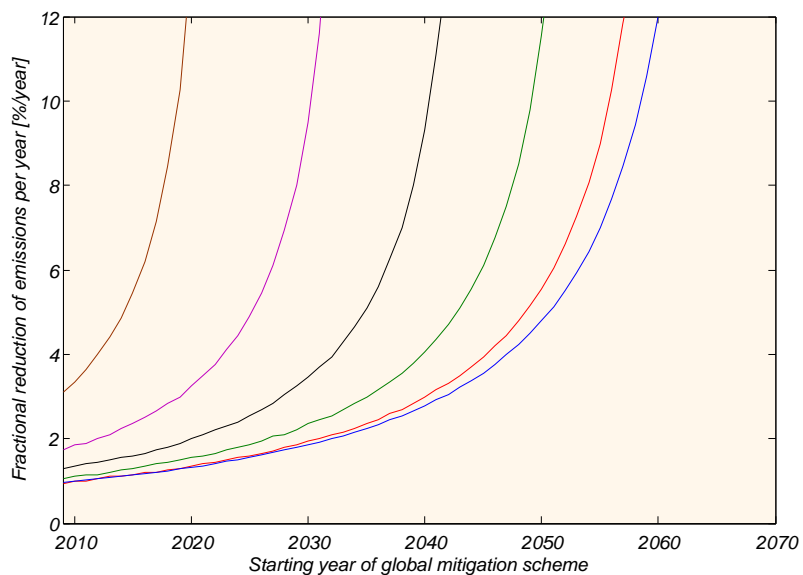

Figure 1.9: *Closing door on 3 degrees target.* Blue line uses Stocker's emission model, red line indicates peak-emissions after one year, green line after 4 years, black line after 9 years, purple line after 16 years, brown line after 25 years

To illustrate the impact of the peak emission year on temperature change, in figs. 1.10 and 1.11 the maximum temperature increase is plotted as a function of the number of years before peak emissions. The different graphs from bottom to top; blue, red, green, brown and purple, indicate different starting year t_1 of the GMS, 2010, 2015, 2020, 2025 and 2030 respectively. Fig. 1.10 is calculated using a limit of 3% decrease per year while in fig. 1.11 s is 10%.

The temperature increase seems to be close to have a linear dependence with the peak emission year. For increasing t_1 (starting year of GMS) the same dependence applies, however shifted to a higher peak-temperature. It might look like the slope of the line increases a bit when postponing t_1 . We also see that increasing the value of s (limit of the fractional emission reductions per year) does not change the dependence, only shifts the graphs to a lower temperature increase for an increasing value of s .

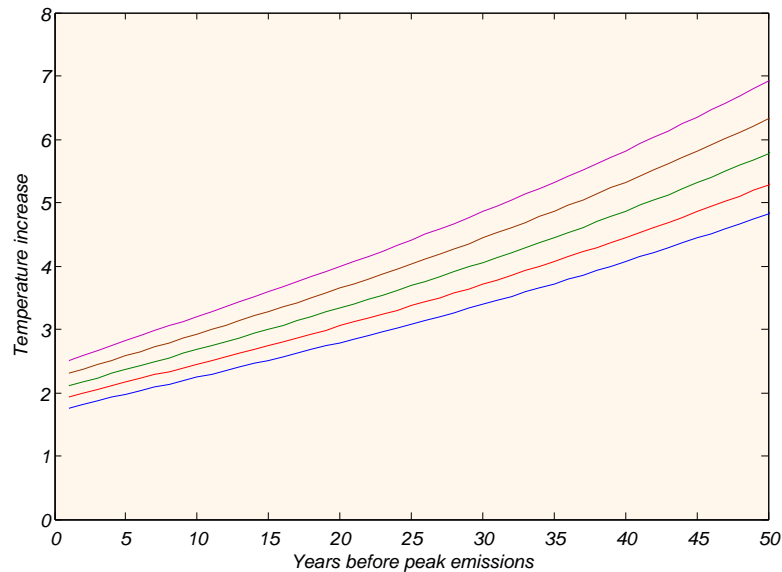

Figure 1.10: Temperature increase as function of years before peak-emissions t_2 for different starting year of GMS. Blue, red, green, brown and purple lines corresponds to $t_1 = 2010, 2015, 2020, 2025, 2030$ respectively. $s = 3$ percent decrease per year

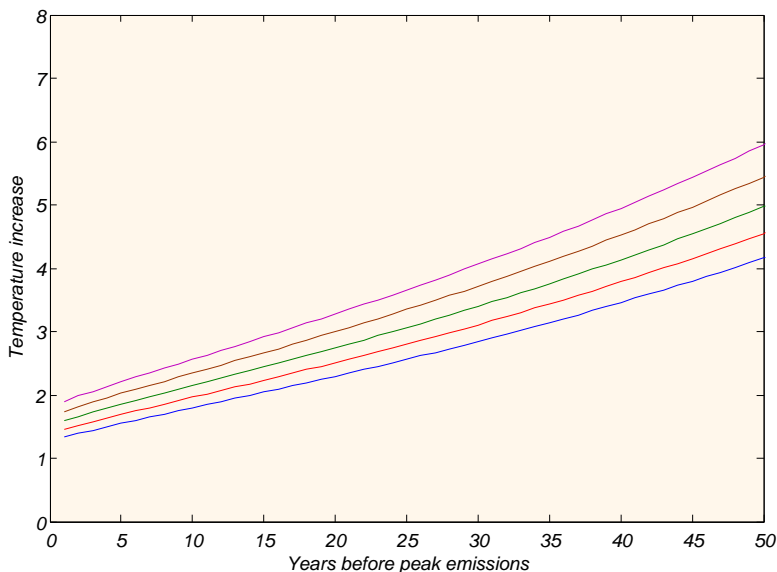

Figure 1.11: $s = 10$ percent decrease

1.1.3 Comments

Using these simple models to estimate carbon emissions and temperature increase, we see that the two most important contributing factors to climate change abatement are *how soon* we can achieve a global agreement on emission reduction, GMS, and *how fast* we can switch to these reductions. It is clear from this model that postponing these major changes will lead to steeper emission reduction rates which will have severe economic disadvantages. We also see that the closing door on a two degree target is approaching fast and that obtaining this target seems more and more unlikely to achieve.

A factor supporting this view is that the models presented above assume that emissions eventually reach zero, something which seems rather unrealistic (some emissions in regards to e.g. food productions are impossible to avoid). Bowerman et al. takes this into account by introducing different emission "floors" in their models [14].

An important factor in these calculations are of course the value of β in eq. 1.1, and the assumption itself that we have a linear dependence between cumulative emissions and temperature increase. Allan et al. claim that β might vary as much as between $1^\circ/\text{TtC}$ and $3^\circ/\text{TtC}$. If the first case occurs it means that the global community has more time to adjust, while the latter would mean that the closing door on the two degree target is already shut, unless measures for actively reducing the CO2 concentration in the

atmosphere could be implemented (so-called "geoengineering").

A remaining hope, if anything, could be that the negative feedback effects (like increased amount of infra-red radiation sent out, the effect on the carbon cycle etc.) of the temperature increase are underestimated by the climate models. In other words that the globe will somewhat stabilize itself and slows down the temperature increase like the human body cures a disease. In that case the peak-temperature could have something like a logarithmic, or even wave-shaped dependence on the cumulative emissions, instead of the linear dependence proposed in eq. 1.1.

1.1.4 Mitigation

The global emissions of greenhouse gases from activities of human beings can in principle be said to be dependent on the following factors: Number of people on earth, energy consumption per person, emissions per unit energy consumed.

Understandably, no politician speaks in favour of actively *reduce* the number of people on earth². Therefore, within the greenhouse gas scenario, the international community has to stimulate emission reductions by either use energy more efficiently (to reduce the energy consumption per person), or to transit from the fossil world we know today to a renewable, emission free future.

Recent reports like IEA's World Energy Outlook 2012 points out that extra attention should be given to the *energy efficiency* part as societies have great potential of consuming energy more efficiently, by using (existing) technology more wisely. Examples are to use heat pumps instead of electricity for heating, proper insulation, more efficient transport etc..

In the following chapters we will discuss the third option, going from the fossil dominated world we know today to a renewable future, with hydropower and tidal energy as basis and background for our discussions.

²Although China's one-child policy was a major grip taken to slow down the massive population *growth*.

Chapter 2

Theory and Technology of Hydropower and Energy Storage

2.1 Potential energy

The basic idea behind hydropower comes from the theory of potential energy stored in the gravitational field. A mass m which is contained at a height h in a gravitational field with a gravitational constant g has a potential energy $E_p = mgh$. When the mass is released in the gravitational field, the energy will be transformed from potential energy to kinetic energy expressed in terms of the velocity v via the relation $E_k = \frac{1}{2}mv^2$. From the basic physical principal that energy is conserved, all the potential energy will be converted to kinetic energy plus some frictional heat losses when the mass has fallen the total height h . This kinetic energy can be used to drive turbines which drive the generators that generate electrical power. The most common turbine technologies will be discussed in section 2.3.

2.2 Basic Equations for a Fluid Flow

2.2.1 The Navier-Stokes Equations.

The governing equations for fluid motion can be derived by performing a momentum balance on a control volume of the flow. The equations will come out in slightly different forms depending on which control volume being used; a control volume of infinitesimal or finite size and either fixed in space or following the fluid flow. Using an infinitesimal control volume following

the fluid flow, Newton's second law gives [58]

$$\rho \frac{Du_i}{Dt} = \rho g_i + \frac{\partial \tau_{ij}}{\partial x_j}, \quad (2.1)$$

where the sum convention $\sum_i a_i b_i \equiv a_i b_i$ has been used, ρ is the density of the fluid, u_i is the velocity vector \mathbf{u} in the i direction, $\frac{D}{Dt}$ is the so called material derivative $\left(\frac{DF}{Dt} = \frac{\partial F}{\partial t} + \mathbf{u} \cdot \nabla F\right)$, \mathbf{g} is the body force (such as gravity and electromagnetic forces) per unit mass so that $\rho \mathbf{g}$ is the body force per unit volume, and $\frac{\partial \tau_{ij}}{\partial x_j}$ is the surface force per unit volume in the i direction. τ_{ij} is the j -component of the surface stress acting on the surface perpendicular to the i direction.

For an incompressible newtonian fluid (like water), the Navier-Stokes eqs. comes out as

$$\rho \frac{D\mathbf{u}}{Dt} = -\nabla p + \mu \nabla^2 \mathbf{u} + \rho \mathbf{g}, \quad (2.2)$$

where the surface forces reduces to pressure forces ∇p and viscous forces $\mu \nabla^2 \mathbf{u}$. ∇ is the differentiation in the spatial directions (in cartesian coordinates $\nabla = \left(\frac{\partial}{\partial x}, \frac{\partial}{\partial y}, \frac{\partial}{\partial z}\right)$), p is the fluid pressure and μ is the fluid viscosity.

2.2.2 The Mechanical Energy Equation

It may often be relevant to consider an energy balance on a fluid element. By multiplying eq. 2.1 with the velocity vector \mathbf{u} and introducing the rate of viscous dissipation ϕ we get [58]

$$\rho \frac{D}{Dt} \left(\frac{1}{2} u_i^2\right) = \rho \mathbf{g} \cdot \mathbf{u} + \frac{\partial}{\partial x_j} (u_i \tau_{ij}) + p(\nabla \cdot \mathbf{u}) - \phi. \quad (2.3)$$

The term on the left represents change in *kinetic energy*, the second term is the rate of work done by body force, the third term is the total rate of work by $\boldsymbol{\tau}$, the fourth term is the rate of work by volume expansion and the fifth is the rate of viscous dissipation.

Eq. 2.3 gives the change of kinetic energy of the fluid element. However, the rate of work by body force can be interpreted as changes in the *potential energy*. This applies if the body forces are conservative, i.e. they may be written as gradients of a scalar potential ζ ; $\mathbf{g} = -\nabla \zeta$. If $\zeta = gz$, g constant, then

$$u_i g_i = -u_i \frac{\partial}{\partial x_i} (gz) = -\frac{D}{Dt} (gz),$$

since $\frac{\partial}{\partial t}(gz) = 0$. If we add this to the left side of eq. 2.3 we get the change in *mechanical energy* as

$$\rho \frac{D}{Dt} \left(\frac{1}{2} u_i^2 + gz \right) = \frac{\partial}{\partial x_j} (u_i \tau_{ij}) + p(\nabla \cdot \mathbf{u}) - \phi. \quad (2.4)$$

2.2.3 Thermal Energy Equation

The fundamental physical principle that energy is conserved leads to the first law of thermodynamics which states that change in the internal energy e of a system for an arbitrary (reversible or irreversible) change of state is given by the sum of the work δW and the heat δQ exchanged with the surroundings. We write

$$de = \delta W + \delta Q. \quad (2.5)$$

The δ sign comes from the fact that work and heat exchange in a small change of state may depend on the way in which the procedure takes place so they may not be exact differentials.

If we let \mathbf{q} be the heat flux vector (per unit area), we get change in internal and kinetic energy as

$$\rho \frac{D}{Dt} \left(e + \frac{1}{2} u_i^2 \right) = \rho g_i u_i + \frac{\partial}{\partial x_j} (\tau_{ij} u_i) - \frac{\partial q_i}{\partial x_i}. \quad (2.6)$$

Since heat added to an element through a surface A with directional vector $d\mathbf{A}$ pointing outward is negative, we get a minus sign on the last term.

If we subtract the kinetic energy equation (eq 2.3) from equation 2.6 we get the *thermal energy equation* or *heat equation*

$$\rho \frac{De}{Dt} = -\nabla \cdot \mathbf{q} - p(\nabla \cdot \mathbf{u}) + \phi. \quad (2.7)$$

We observe that the ϕ , the viscous dissipation, enters in the heat equation with a positive sign whereas it appeared in the mechanical energy equation with a negative sign. This is expected as viscous dissipation represents friction between the molecules in a fluid when it is deformed and results in transfer of mechanical energy to heat [58].

2.2.4 The Bernoulli Equation

From the Euler equations (the Navier-Stokes eqs. with no viscosity) one can derive the famous Bernoulli equation. When body forces are conservative

the Euler eq. can be written as

$$\frac{\partial \mathbf{u}}{\partial t} + \nabla B = \mathbf{u} \times \boldsymbol{\omega}, \quad (2.8)$$

where \mathbf{u} is the fluids velocity vector, $\boldsymbol{\omega} = \nabla \times \mathbf{u}$ is the vorticity vector equalling the curl of the velocity, and B is the Bernoulli term;

$$B = \frac{1}{2}q^2 + \int \frac{dp}{\rho} + gz = \frac{1}{2}q^2 + \frac{p}{\rho} + gz. \quad (2.9)$$

Here $q^2 = u^2 + v^2 + w^2 = \textit{twice the kinetic energy}$. The last equality holds if the fluid is incompressible (ρ can be left out of the integration over pressure). Since $\mathbf{u} \times \boldsymbol{\omega}$ is equal to zero along streamlines (lines following the motion of a fluid particle) or vortex lines (lines where the fluid has no *vorticity* or *curl*, $\boldsymbol{\omega} = \nabla \times \mathbf{u} = 0$), for a steady flow ($\frac{\partial \mathbf{u}}{\partial t} = 0$), the Bernoulli term B will be constant along these lines.

$$B = \frac{1}{2}q^2 + \frac{p}{\rho} + gz = \textit{constant along streamlines and vortex lines} \quad (2.10)$$

If one considers a flow in one dimension, e.g. flow in a pipe, between two points a and b we get the relation

$$\frac{1}{2}u_a^2 + \frac{p_a}{\rho} + gz_a = \frac{1}{2}u_b^2 + \frac{p_b}{\rho} + gz_b \quad (2.11)$$

which is referred to as the *one dimensional Bernoulli's equation for a steady flow*.

In hydrodynamics one often talks about the head of a fluid. The head is often given as a unit of length and can be obtained by dividing the Bernoulli's equation by the gravitational constant g and gather all terms on one side. The different heads are then defined as

$$\textit{Velocity head} = \frac{u_a^2 - u_b^2}{2g}$$

$$\textit{Pressure head} = \frac{p_a - p_b}{\rho g}$$

$$\textit{Elevation head} = z_a - z_b$$

When dealing with hydropower plants the head is usually referring to the height difference between the upper and lower reservoir, namely the elevation head.

Since water has viscosity, there will be some losses in the pipe not accounted for in the original Bernoulli's eq. This leads to the inclusion of work done by friction, h_f which could be caused by roughness of the surface in contact with the fluid, pipe bends, change of size of cross sectional area which the fluid flows through, turbulence, fittings, valves etc.. Also, if the flow is driven by a pump, one can include pump work, W_p with an efficiency η , to the original Bernoulli equation, giving the so called *Engineering Bernoulli's equation* [66]:

$$\frac{1}{2}\alpha_a u_a^2 + \frac{p_a}{\rho} + gz_a + \eta W_p = \frac{1}{2}\alpha_b u_b^2 + \frac{p_b}{\rho} + gz_b + h_f \quad (2.12)$$

The constants denoted by α , are correction factors for using the bulk velocities of the fluid instead of a velocity distribution over the cross section of the flow.

Equation 2.12 is used extensively (often together with measurement techniques such as a Pitot tube) in fluid dynamics as well as chemical engineering to determine properties of fluid flows.

2.3 Turbines

To be able to convert the mechanical energy in a fluid flow to electrical energy, one needs a turbine that can drive a generator to generate electrical power. Depending on the available head and the discharge, turbines generally operate in two different ways:

Impulse turbines

Impulse turbines (or action turbines) use only the kinetic energy of a fluid flow (the velocity head). The direction of the flow is changed so that it loses its velocity and thus transfers its impulse I to the runner, forcing it to spin. Impulse turbines use the principles of Newton's second law:

$$\sum \mathbf{F} = m\mathbf{a} = m\frac{d\mathbf{v}}{dt} \quad (2.13)$$

$$\mathbf{I} = \int \mathbf{F}dt = \int m\frac{d\mathbf{v}}{dt}dt = m(\mathbf{v} - \mathbf{v}_0), \quad (2.14)$$

so the impulse transferred to drive the turbine is proportional to the difference in velocity prior to entering, and after leaving the turbine. Before the water interacts with the turbine blades, the flow is accelerated by flowing through a nozzle, and thereby loses most of its fluid pressure (cf. Bernoulli's principle).

The most commonly used impulse turbines are the basic water wheel, the Pelton turbine and the cross flow turbine.

Reaction turbines

Differing from impulse turbines, reaction turbines use both the kinetic energy of the fluid (velocity head) *and* the fluid pressure (pressure head) to drive the turbine. The fluid flow is accelerated inside the turbine leading to a loss of static pressure. Obeying Newton's Third Law the lost fluid pressure is equal to the pressure acting on the surroundings of the fluid (the runner). The pressure forces in addition to forces from the fluid hitting the runner blades, cause the runner to spin.

The most commonly used reaction turbines are the propeller type turbine, the Francis turbine and the Kaplan turbine.

2.3.1 Pelton turbine

The Pelton wheel is an impulse turbine invented by Lester Allan Pelton in the 1870s [139]. The water flows in through nozzles tangential to the runner, where it hits spoon-shaped buckets. The flow is decelerated in the buckets, entering with a high velocity and leaving with nearly zero velocity and thereby exerting an impulse to the wheel, forcing it to spin. The buckets are designed so that when the runner speed is one half of the speed of the water jet, the water leaves the turbine with nearly zero velocity, exerting almost all of its energy to the turbine.

The Pelton wheel is especially appropriate for high-head applications (from 60 m to about 1,000 m) [102].

2.3.2 Francis turbine

The Francis turbine is a reaction turbine invented by James B. Francis in 1846 [139]. The water enters the turbine tangentially through a spiral casing (1, fig 2.1) and flows inwards towards the middle. Due to conservation of angular momentum the flow will speed up as it gets closer to the center of the spiral and thus lose pressure. The fluid flows through mobile guide vanes (point 2), used to regulate the discharges, before arriving at the runner (3). At the runner outlet the water flows axially into a draft tube (5) before being returned to the river or lower reservoir. Pressure and impulse is acting on the runner blades forcing the runner to spin. The runner is then connected to a shaft (4) which drives the generator to generate electricity.

Francis turbines are widely used and can operate with heads extending from 25 to about 250 m. However, it is preferred to Pelton turbines for head higher than 60 m when the discharge is especially important and not

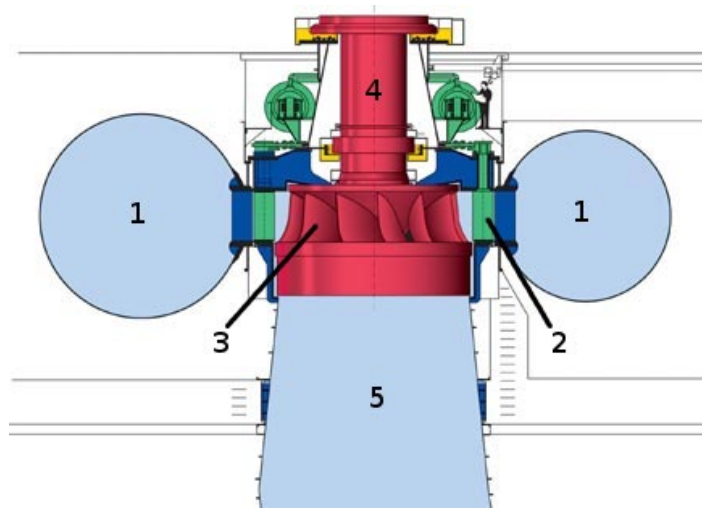

Figure 2.1: Francis turbine: 1) Spiral casing, 2) Guide vanes, 3) Runner, 4) shaft, 5) draft tube. [133]

very variable, thus is the Francis type turbine mostly used for medium head applications [102].

In addition to the ability of regulating the guiding vanes, there exists turbines that are able to also adjust the angle of the runner blades. These turbines are often called diagonal turbines and may often replace Pelton turbines for heads between 60 and 100 m when the discharge is especially large and variable.

2.3.3 Propeller- and Kaplan Turbine

Instead of using the Francis runner blades, the propeller turbine lets the water flow through propeller shaped blades. If the angle of the propeller blades are adjustable the turbine is called a Kaplan turbine, developed in 1913 by the Austrian professor Viktor Kaplan [139]. The Kaplan turbine can either have a spiral inlet casing as the Francis turbine, or an axial inflow. They often also have adjustable guiding vanes providing variability of the discharge.

The Kaplan turbine is efficient with heads varying from 2 to about 30 m, thus being widely used in small hydro schemes and river hydropower [102].



Figure 2.2: Voidth-Siemens Francis runner used in the Three Gorges plant. [133]

2.3.4 Cross flow turbine

The cross flow turbine, also called Banki-Michell turbine or Ossberger turbine, was developed in 1903 by the Australian Anthony Michell, the Hungarian Donát Bánki and the German Fritz Ossberger [132]. The design is an impulse turbine where the water flows through the turbine transversely, or across the turbine blades, as opposed to most water turbines with axial or radial flow. The flow is accelerated through nozzles before entering the turbine and transferring its impulse to the runner blades.

Cross flow turbines generally have lower efficiency (about 70-80%) than the other turbines mentioned above, but because of its simplicity and cheap design, it may be used in mini or micro hydropower schemes, for example in the case of rural electrification in developing countries.

Pelton, Francis and Kaplan turbines all reach efficiencies of about 90 % and even higher, enabling elevated water energy conversion to be as efficient as it really is. In figure 2.3 the efficiencies of the various turbines are plotted as functions of the relative discharge.

2.4 Pumps and Reversible Turbines

Pumps are used to drive a liquid flow e.g. from a lower water reservoir to an upper in a pumped hydro scheme. The pump uses power from an

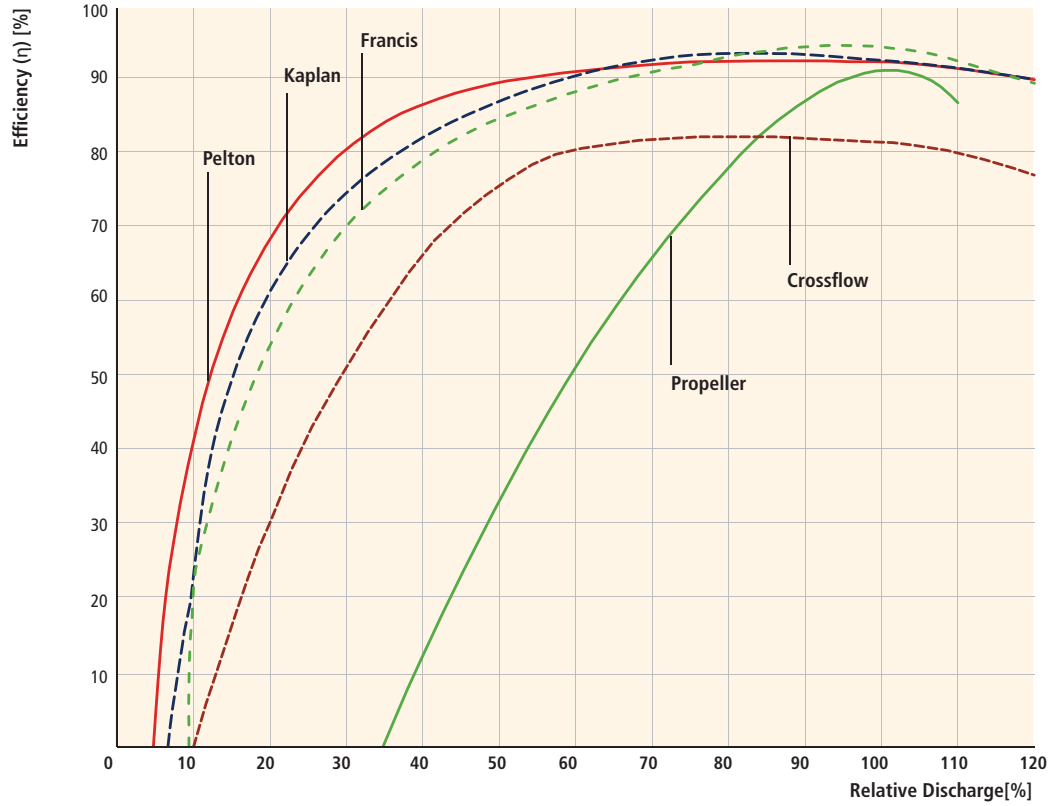

Figure 2.3: Various turbine efficiencies as function of the relative discharge. Source: [55]

external source (often electrical power from the electricity grid) to perform work on a fluid. To calculate the power requirements of a pump, we apply the engineering Bernoulli's equation (eq. 2.12) between a point a just before the inlet of a pump, and point b just after the outlet of the same pump, and solve for the work done by the pump on the fluid;

$$\eta W_p = \left(\frac{1}{2} \alpha_b u_b^2 + \frac{p_b}{\rho} + g z_b \right) - \left(\frac{1}{2} \alpha_a u_a^2 + \frac{p_a}{\rho} + g z_a \right). \quad (2.15)$$

The frictional losses in the pump are implemented in the pump efficiency η , and therefore not included in the equation (the height difference before and after the pump is usually negligible and can also often be left out). The terms inside the parentheses on the right hand side are called the *total heads* of the fluid, so that the right hand side is the *head difference*, ΔH , between a and b and is referred to as the head developed by the pump. Thus we have

$$\eta W_p = \Delta H. \quad (2.16)$$

The power requirements, P , of the pump from the external source can be calculated by multiplying the pump work with the mass flow, \dot{m} , of the fluid, equalling the developed head divided by the pump efficiency η ;

$$P = \dot{m}W_p = \frac{\dot{m} \Delta H}{\eta}. \quad (2.17)$$

Pump technologies

Over time many different pump technologies have been developed, with the two major classes being positive-displacement pumps and centrifugal pumps. Positive displacement units apply pressure directly to the liquid by a reciprocating piston, or by rotating members which form chambers alternately filled by and emptied of the liquid. Centrifugal pumps generate high rotational velocities, then convert the resulting kinetic energy of the liquid to pressure energy.

2.4.1 Positive-Displacement Pumps

In positive-displacement pumps a definite volume of liquid is trapped in a chamber, which is alternately filled from the inlet and emptied at a higher pressure through the discharge. Reciprocating pumps and rotary pumps are two subclasses of positive-displacement pumps. Reciprocating pumps use a piston or plunger to apply pressure to a fluid contained in one or more cylinder(s). In the rotary pump the chamber itself is moving between inlet, where it is filled with liquid, and discharge, where the liquid discharges with higher pressure, caused by rotating parts in the pump [66].

2.4.2 Centrifugal Pumps

In centrifugal pumps, the mechanical energy of the fluid is increased by centrifugal action. The liquid enters the pump parallel to the rotating axis and is accelerated by the impeller connected to the rotating shaft. The curved blades on the impeller lead the flow radially outwards and into a diffuser or volute chamber (casing), from where it exits.

Except in very small pumps the impeller blades are curved backward, opposite to the direction of rotation. The blade tips are at an angle β with the tangent to the circular rim of the impeller. Angle β is almost always less than 90° ; if it is greater than 90° , with forward curving blades, flow in the piping system may become unstable [66].

Figure 2.4 shows a schematic illustration of an ideal centrifugal pump ($\eta = 1$) with no friction or other flow disturbances. The flow leaves the

impeller blades with a velocity \mathbf{V}_2 , at an angle 90° to the blade surface. The velocities at the entrance (1) and exit (2) of the impeller can then be decomposed as shown in the figure. Since the rate of increase of moment of momentum (angular momentum) equals the moment acting on the fluid (the torque T) we get

$$\dot{m}(\mathbf{r}_2 \times \mathbf{V}_2 - \mathbf{r}_1 \times \mathbf{V}_1) = \mathbf{T}. \quad (2.18)$$

Since the fluid enters radially, i.e. $\mathbf{V}_1 \times \mathbf{r}_1 = 0$, we get

$$\dot{m}r_2V_{u2} = T. \quad (2.19)$$

The power P delivered to the fluid is then¹

$$P = T\omega = \dot{m}r_2V_{u2}\omega. \quad (2.20)$$

Using the Engineering Bernoulli's equation 2.12 between points a and b at the entrance and exit of the turbine, we get

$$W_p = P/\dot{m} = \omega r_2 V_{u2} = \Delta H. \quad (2.21)$$

From fig. 2.4 we find $V_{u2} = u_2 - V_{r2}/\tan\beta$, and since the tangential velocity of the tip of the blade, $u_2 = r_2\omega$, and the flow radial velocity V_{r2} is equal to the volume flow, q , divided by the cross sectional area A_p , we get

$$W_p = u_2\left(u_2 - \frac{q}{A_p \tan\beta}\right) = \Delta H. \quad (2.22)$$

As u_2 , A_p and $\tan\beta$ are constant, eq. 2.22 indicates that the developed head varies linearly with the volume flow q .

In actual pumps the efficiency η is reduced due to friction and also shock losses from sudden changes in direction of the liquid leaving the impeller. The velocity in a given cross section is also far from uniform, resulting in circulating flow within the impeller channels. Thus the power needed to develop a certain head is considerably larger than in the ideal case.

2.4.3 Reversible Francis turbine

A Francis turbine can in principle operate in reverse by changing the direction of the turbine so that it works like a centrifugal pump. Water is drawn in axially by the runner blades (impeller), through the vanes and out through

¹*Power = force × distance per second = force × arm × angular velocity = torque × angular velocity.*

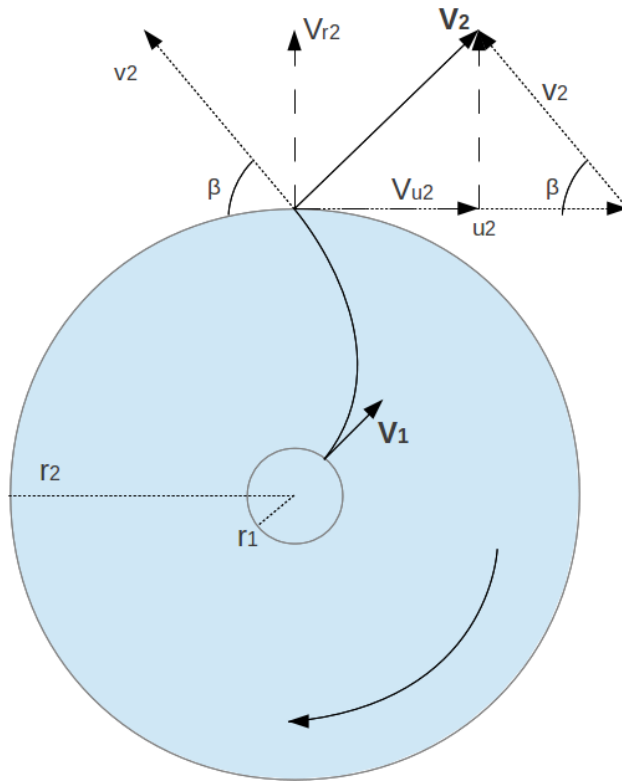

Figure 2.4: Schematic drawing of velocity vectors in an ideal centrifugal pump

the spiral casing. A pump-turbine differs in design compared to pure pump or turbine design as it has to make compromises in optimisation design between pumping and turbine mode. In pumping mode the pressure is higher than in turbine mode as pressure losses in piping (represented in the ϕ term in eq. 2.3 and the h_f term in eq. 2.12) have to be added to the pump head when pumping, while it is lost during turbine mode. The design of the runner blades has to be determined by the pumping head, so that the head in turbine mode is lower than what the runner blades are designed for. As a consequence the turbine should be run with a slightly lower rotational speed than the synchronous speed ($\eta_{opt} < \eta_{sync}$) to obtain optimal hydraulic operation [1].

Another constructional design consideration which has to be made is to the tip of the runner blades which has to be curved backwards, as described in section 2.4.2, with an angle $\beta < 90^\circ$ relative to the tangent of the runner to avoid flow disturbances which reduce the flowrate. Because of this the runner has to consist of fewer blades and with a curvature somewhat different from

the regular Francis turbine (see fig. 2.5). The additional blade tip may reduce the efficiency and cause higher costs.

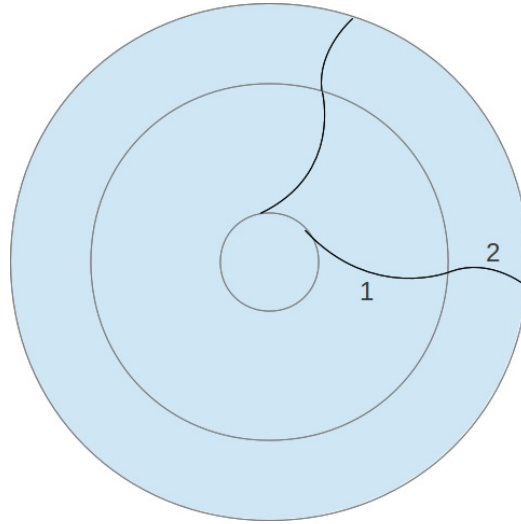

Figure 2.5: Francis runner for pump-turbine: 1) Regular Francis blade curvature, 2) additional blade tip for pumping

As a consequence of the modifications in design described above, the flowrate of the reversible pump-turbine is very sensitive to the rotational speed, so that instabilities, and problems with synchronization with the grid during transition from pump- to turbine mode and vice versa, are considerable challenges when dealing with reversible turbines [117].

2.4.4 Variable speed pump-turbine technology

In recent years the major pump-turbine producers (e.g. Voith, Andritz, Alstom, Hydro) have spent a lot of resources on research and development of pump-turbines with variable rotational speed technology. With this technology the turbine can run with optimal speed ($\eta_{opt} < \eta_{sync}$). It also leads to higher efficiency, less vibrations and noise and gives the opportunity to instantly adjust the power output to the demands in the electricity grid [1], an attribute which could become increasingly important in a future energy system.

In pumping mode the main advantage of variable speed technology is the opportunity to vary the power consumption at constant head. With today's design it is possible to vary the speed by $\pm 10\%$ providing $\pm 30\%$ variability in power consumption to the nominal level [1]. It is therefore possible to reduce

power consumption to about 60% of maximal consumption. This means that two variable speed pump- turbines connected could run at 60 to 100 %, and 120 to 200 % of the maximal power consumption of one turbine (two pumps without variable speed technology could only run on either 100% or 200%). In a pumped storage scheme with several reversible pump-turbine units, two of them should have the possibility of varying speed. In this way the plant could run at 60-100%, 120-200%, 220-300%, 420-500%... of maximal power giving great variability.

Variable speed reversible pump-turbines acquire frequency conversion (either as a frequency converter connected to a synchronous generator, or an asynchronous generator with or without a frequency converter). This increases costs so that a third unit with variable speed technology would probably not be economically reasonable. Development in technology also indicates that pump-turbines with $\pm 50\%$ variability in power consumption will be available in years to come [1].

2.5 Design Challenges and Possible Improvements

2.5.1 Cavitation

An issue of great importance regarding design of hydraulic machines such as propellers, turbines and pumps, is cavitation. Cavitation is the formation and then immediate implosion of cavities in a liquid, i.e. the formation and bursting of small bubbles. Cavitation occurs if localized pressure of a fluid drops below the vapor pressure, and is often present at areas of rapid change of fluid velocity. Cavitation is usually an unwanted phenomenon as it reduces efficiency and often causes severe erosion and significant damage to machinery.

In a hydraulic pump, the pressure on the suction side of the pump (suction pressure) has to be larger than the vapor pressure to be able to draw any liquid into the pump. In addition, the suction pressure has to be larger than the vapor pressure by some value, or else some water will flash into vapour and cause cavities. The so-called *net positive suction head* (NPSH) is a quantity defining how much larger the suction pressure should be relative to the vapor pressure to avoid cavitation. When pumping from a lower reservoir with surface pressure p_a using a pump situated at a height z_a relative to the surface level of the lower reservoir, NPSH is defined as

$$NPSH = \frac{1}{g} \left(\frac{p_a - p_v}{\rho} - h_f \right) - z_a \quad (2.23)$$

where p_v is the vapor pressure and h_f are the frictional losses. NPSH increases with pump capacity, impeller speed and discharge pressure, and values up to 15 m are recommended for very large pumps [66].

2.5.2 Multiphase flows

Another topic of importance when considering design of hydropower technology is multicomponent- and multiphase flows². Lots of research involves description, calculation and simulation of coupling effects (mass-, momentum- and energy coupling) between phases and components. A hydropower plant in a developing country may contain flows that differs quite much from the ones in a Norwegian hydropower plant, perhaps with more slurry flows at different temperatures and so on. Such issues, in addition to different investment capabilities and other preconditions, could make hydropower development in for example Africa different from the development in countries like Norway.

One other challenge related to multiphase flows is to optimise bucket shapes of Pelton turbines, where the flow contains multiple drops, turbulence and splash. Simulations of such complicated systems is a field of research that is continuously developing.

2.5.3 Research and development

The field of fluid modeling and *computational fluid dynamics* (CFD) - simulations of fluid flows, has seen an incredible development the last decades. Since CFD is used widely in areas such as safety assessments in offshore industry, space sciences, air plane-, car- and submarine design, sports, and so on, huge amounts of money have been invested on research in this field. Different software, both commercial and free, have been developed using different techniques for different purposes. CFD is basically to use computer algorithms to create numerical solutions of the governing equations of a fluid flow presented in section 2.2. As computer technology rapidly develops (faster and faster super computers), so does CFD, enabling more detailed solutions of more complex flows. A lot of research is being performed using CFD as a tool for optimizing shapes and design of hydraulic devices.

After the deregulations of power markets around the world, generation of power has been controlled by the variations in price which continuously follows variations in demand. This has lead to a more fluctuating power generation so that the hydropower technology should be able to adjust to these

²Cavitation is an example of single-component multiphase flow as it is flow of a single component (water) containing both liquid phase and gas phase

fluctuations. Before the regulations, a reversible turbine could be designed to constantly pump during summer and generate during winter, or pump at night-time and generate at daytime, whereas it now often needs to switch between pumping and turbine mode several times a day due to variations in price. This requires research in e.g. variable speed technology, different start up techniques for reversible turbines, more flexible frequency converters and generators etc..

2.6 Energy Storage Technologies

One of the main challenges related to a renewable energy system is to balance fluctuations from intermittent sources like wind- and solar power. To be able to take advantage of these sources even when the wind isn't blowing and when the sun doesn't shine, solutions for energy storage have to be developed. Below is a brief presentation of different available energy storage technologies.

2.6.1 Pumped Hydro Storage

Pumped hydro storage (PHS) is by far the most developed energy storage technology available today. The technique has been around for about a century and basically works as a hydropower plant in reverse. The idea is to use electrical power to pump water uphill to an upper reservoir, where it is stored as potential energy. Whenever there's a power shortage, the water is released to flow down through turbines converting the energy back to electrical power.

The main advantages of PHS are the high storage capabilities and the high efficiencies of such a cycle of about 70-85 % with current technology [8]. The losses are caused mainly by viscous dissipation in piping, in addition to losses in pumps, turbines and during electricity conversion.

The main disadvantage of pumped hydro storage is that suitable sites (large reservoirs) are limited and unevenly geographically distributed. Therefore, PHS is not capable of covering all balancing needs alone, using existing reservoirs. However, another opportunity is to *build* the upper reservoirs, and use lakes or even the sea as the lower reservoir. Some of such plants already exist, although they are, understandably, associated with significant environmental issues.

Another idea is to build reservoirs *down* in the sea. When there's an excess of power, water could be pumped out of these reservoirs, and during times of power shortage, water could be allowed to flow back in through turbines to

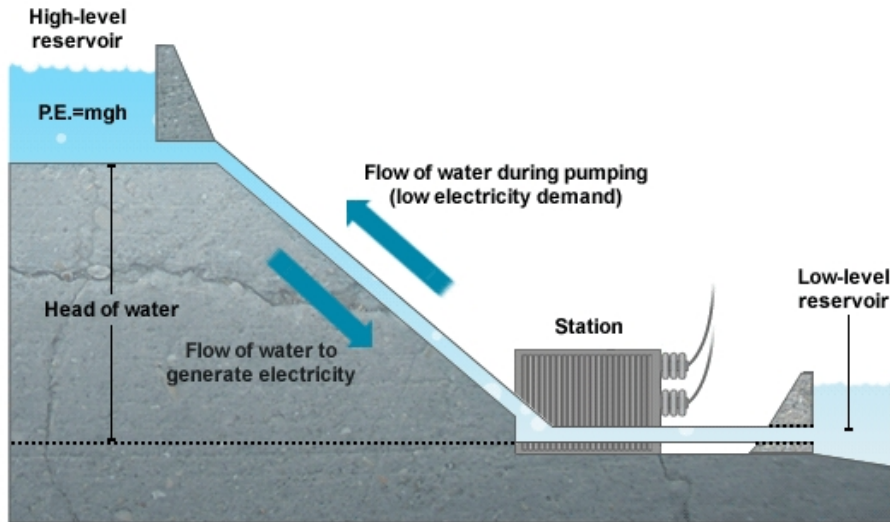

Figure 2.6: Water is pumped from the low-level reservoir to the high-level reservoir when there's an excess of power in the grid. Here the energy is stored as potential energy mgh , before it is allowed to flow down through turbines to generate power in times of power shortage in the grid. Source: [11].

generate power. An example is a Danish initiative called *Green Power Island*, which suggests to construct artificial islands with a deep central reservoir, and with windmills on top that can provide power to drive pumps to empty the reservoir [44].

In principle, energy storage as potential energy mgh for a mass m elevated to a height h could be performed by all sorts of materials, not only water. The California-based company ARES (Advanced Rail Energy Storage) has developed and patented a technology for elevating heavy masses between two storage yards at different elevations using low-friction railways [122]. They claim their technology is more efficient than pumped hydro (around 80%), using well-known technology that is easily scalable.

Pumped hydro storage will be further discussed in section 3.5.

2.6.2 Compressed Air

A well-proven technology for energy storage is to inject compressed air in underground caverns. The compressors are driven during off-peak hours to

pump the air down. When there's a power shortage, some of the compressed air is let out to drive turbines, generating electricity to the grid.

Little compressed air-storage capacity has yet been developed globally. In Alabama, a site run by PowerSouth Energy Cooperative, has been operated successfully for 20 years with ability of providing a respectable 110 MW for up to 26 hours. A similar site is operated by E.ON Kraftwerke in Huntorf, Germany [20].

Compressed air energy storage has benefits of having relatively high cost-effectiveness and is fairly easily scalable. However, since air heats up when compressed, and cools down when the pressure drops, some sort of heat management is needed, reducing the overall efficiency. In the sites mentioned above, natural gas is being burned to heat up the expanding air to prevent the released air to freeze everything it touches. This undermines some of the purpose of introducing more renewables, as greenhouse gases are emitted. There are, however, different technologies being developed (insulated caverns, heat transfer to solids or liquid reservoirs, and more), to avoid heat-losses in caverns, and maintaining relatively high efficiencies [20].

2.6.3 Thermal Storage

Thermal storage is to store energy as heat. An example is to use concentrated solar power to heat substances of high heat capacity such as molten salt or water, and later use heat exchangers to boil water that drives steam generators to generate power. In such a way, solar energy combined with thermal storage could generate power 24 hours a day (a milestone achieved for the first time in 2011 in Andalusia, Spain) [20].

On a smaller scale, thermal storage could be used for heating of large buildings during off peak hours, which could dampen the daily fluctuations in demand. Heat could also be used for seasonal storage by storing heat in some sort of thermally isolated reservoir during summer and retrieve some of the heat at wintertime, e.g. by using heat pumps.

Thermal storage can involve cold instead of hot, too. Ice thermal storage (often called ice energy) involves using off-peak electricity to produce ice at night, then use the melting ice at daytime to drive air conditioners for cooling. A number of such sites exist [74], most of them in USA, enabling cheaper cooling and balancing fluctuations in power demand.

2.6.4 Flywheels

Another way of storing energy is to store *kinetic energy*, energy contained in masses in motion. Flywheels consists of heavy devices that spin and thus

contain easily extractable rotational energy.

The largest storage plant in the world using flywheels is the Beacon New York Flywheel Energy Storage plant using 200 individual spinning masses, providing power of 20 MW for 15 minutes (5 MWh), thus suitable for balancing short term fluctuations in the grid [74].

Flywheels are also used as small-scale energy storage e.g. by regenerative braking in trains and racing cars.

2.6.5 Hydrogen

For more than two centuries scientists have split water into hydrogen and oxygen by running an electric current through it. The hydrogen can later be consumed in a fuel cell to generate electricity. Many people and institutions are speaking in favour of making hydrogen the most important energy carrier, used extensively for storing energy. One could imagine each resident having their own small power stations, using off-peak electricity to split hydrogen which can be used later to generate power, or run a hydrogen car. Another option is to store hydrogen in large underground caverns.

The challenge is to both split water and "burn" hydrogen without producing too much waste heat. With current technology energy storage as hydrogen is expensive, and has relatively low energy efficiency [20]. The efficiency could be much higher if sunlight were used directly, like plants harness the sun for hydrolysis during photosynthesis. This is possible today, however at high costs and with low efficiencies.

Fuel cells are today quite efficient, but rely on expensive catalytic materials such as platinum. Another challenge regarding hydrogen is that the gas is explosive and needs to be liquefied or compressed.

Nevertheless, much effort is put into research on hydrogen technology hoping one day to overcome above-mentioned challenges. If successful, this could lead to the long-envisioned hydrogen economy, with emission-free fuel extracted from sea-water using the sun - sources which are abundant.

2.6.6 Batteries

Battery technology has come a long way on small scale energy storage, for our cell-phones, PCs, and all the other electrical devices we possess. In addition, electric cars are entering the market at a noticeable pace. For grid-scale storage, a number of sites exist with capacity of up to 36 MW, with ability of storing some tens of MWh [74].

Batteries have the benefit of being easily scalable, and can be turned on and off instantly. The main challenge of large-scale storage using batteries is

to reduce costs. Batteries can be constructed in many ways using different substances as electrodes and electrolytes, though existing compositions are expensive relative to other storage techniques. Thus more radical redesigns may have to be developed to sharply reduce costs. An example is a type of battery developed by professor Donald R. Sadoway at Massachusetts Institute of Technology (MIT) that he calls "liquid-metal battery". Its simple design consists of a cylindrical vat kept at high temperature and filled with two molten metals, separated by a molten salt between them. As Sadoway says: "*If you want to make something dirt cheap, make it out of dirt – preferably dirt that is locally sourced*" [103]. The liquid-metal battery is so far at a stage of "pizza-box-size" batteries in the lab, but Sadoway thinks they will scale up economically, perhaps even cheaper than pumped hydro storage.

Other examples of new battery designs are such as the flow battery, which inside a container uses a solid-state membrane that separates two liquid electrodes. Another is a so-called aqueous hybrid ion (AHI) technology developed by Aquion - a company in which Bill Gates recently has invested 35 million dollars, and that has been listed as one of MIT Tech Review's 50 Disruptive Companies of 2013 [29, 99].

Many believe batteries could be the ideal storage medium for intermittent power sources, and, in addition, that "smart" charging of decentralized batteries (e.g. batteries in electric cars) could play a significant role in balancing fluctuations in power demand [20, 64].

Chapter 3

Hydroelectric Power

”Norge stod for ham som elektricitetens forjættede land; fra dets utallige fosser kan hele verden forsynes! Han så landet ligge i vintermørke, omglødet af elektrisk glans, han så det også som en verdensfabrik med skibe foran.”[12]

The quote is from ”Absalons Hår”, written in 1894 by the Norwegian Nobel price winning writer Bjørnstjerne Bjørnson (1832 - 1910). The main character, Rafael, a young electrical engineer educated in Europe, sees the potential in Norway’s countless waterfalls to supply the whole world with electricity.

Although we know today that the waterfalls are not countless, and that there’s a great demand for energy to be met, both domestically and abroad, the utilization of the Norwegian hydropower is, and will be a highly current topic in years to come. The idea of using Norwegian hydropower as a ”green battery” for Europe, with a high share of power transmission, has been spoken of as a possible future role of Norwegian hydroelectric power, and somewhat corresponds with the thinking of ”Rafael” at the end of the 19th century.

Using hydropower to produce electricity is today the most developed renewable energy technology with experience from over a century of operation. Hydropower is today the world’s by far largest installed renewable energy source for electricity production with a share of about 15.9 percent (2011) [15]. This corresponds to 6.4 percent of the world’s total energy consumption when tradeable fuels are considered. In comparison with other renewables, which contribute an additive share of 3.9 percent of electricity production and 1.6 percent of total consumption, we may conclude that hydropower is still the only stand alone renewable energy source with significant impact on the *global* energy balance today.

On a local scale, in countries with lots of waterfalls, hydropower can be absolutely vital. This is the case for example in Norway, where hydropower generation corresponds to nearly 100 percent of the country's consumption of electricity. Being the country in the world with the highest amount of its energy consumption (all sectors) covered from hydropower, Norway is in a rather unique position compared to most countries.

3.1 A Historical View and Status of Hydropower

3.1.1 Global development and capacity

Before the invention of the electric generator, mechanical energy in falling water was utilized for services and productive uses. Over two thousand years ago the Greek used hydropower to operate wheat mills for grinding wheat into flour. During the 1700s, mechanical hydropower was used extensively for milling and pumping. In Norway it was especially important in the wood industry, both driving watermills connected to timber saws, but also using river flows for transportation of timber.

In the late 19th century, when the electric generator was invented, hydropower could be used for the first time to generate electricity. The first hydroelectric power schemes were installed around 1880 in England and USA, generating electricity for lighting. Around the change of the century, and during the first part of the 20th century, hydropower experienced a great development in the West and Pacific Northwest driven by the rapid increase in demand for electrical power in the wake of the industrial revolution.

In the last part of the 20th century and up until today the electricity consumption from hydropower has been rather steady in North America and Europe (at least since the '80s). However, Asia and South America has had a great development over the same period of time. This can be seen in figure 3.1. The rapid development in Asia, especially in China with a 700 percent change in electricity consumption since 1987 [15], has made Asia the world's largest consumer.

In the beginning, hydropower primarily provided electricity locally where there was flowing water and a demand for energy. Gradually, as the electrical power transmission system developed, hydropower was used more and more for centralized electricity production. This meant construction and utilization of larger water magazines providing electricity to the power net. Today there is a large variety of hydropower plants, making it possible to meet both large urban energy needs, as well as decentralized rural needs.

The largest hydropower plants are located in Asia and South America.

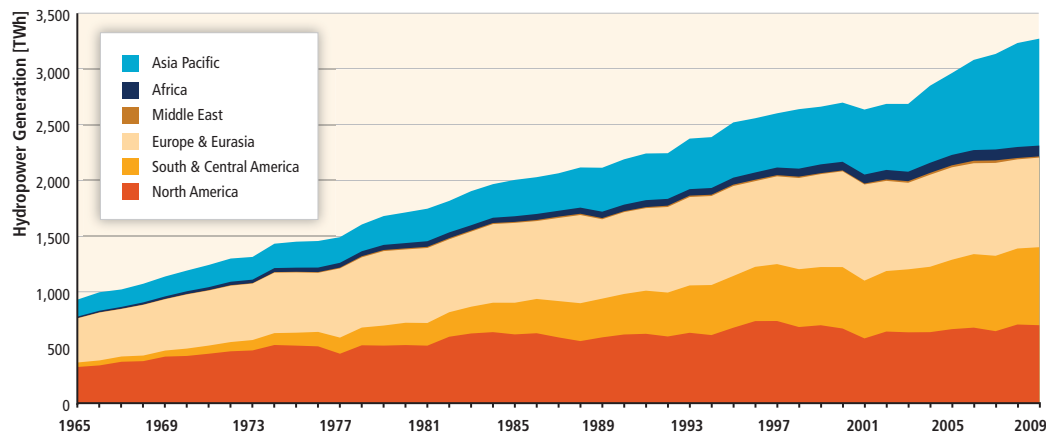

Figure 3.1: Development of region specific hydropower generation since 1965. Source: IPCC Special Report on Renewable Energy, Chapter 5 Hydropower [56].

The Three Gorges Dam in the Yangtze River in China was fully functional in 2012 with a maximum capacity of 22,500 MW, thus being the world's largest regarding capacity. The Itaipu dam (operational since 1984) located at the border of Brazil and Paraguay has a capacity of 14,000 MW, but as it has less seasonal fluctuations in volume flow, the Itaipu site is able to generate slightly more energy annually than the Three Gorges (both generating about 80 - 100 TWh/year, which is comparable to the total Norwegian power consumption of 120 TWh/year). The third largest is the Guri dam in Venezuela with a capacity of 10,200 MW, and the largest hydropower plant outside Asia and South America is the Grand Coulee Dam in the State of Washington, USA, with a capacity of 6,809 MW. The three largest dams under construction are the Xiluodu Dam (13,860 MW, China), Baihetan Dam (13,050 MW, China) and Belo Monte Dam (11,000 MW, Brazil) [85, 134].

Figures 3.2 and 3.3 show the development of yearly consumption of hydropower, and installed capacity per country, for the eight largest consumers, China, Brazil, Canada, USA, Russia, India, Norway and Venezuela.

3.2 Development of Hydropower in Norway

In Norway, the mechanical energy available from waterfalls and river flows had been utilized to an increasing degree during the 19th century. When electricity was introduced around the 1880s, it was first used exclusively for lighting, but when electric motors became available in the 1890s (making it possible to transform electrical energy to mechanical energy), other appli-

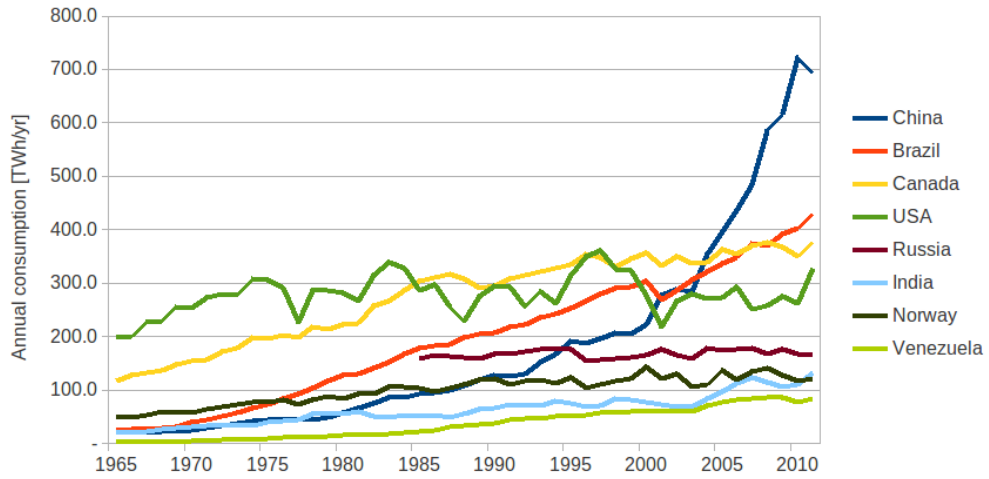

Figure 3.2: Development of country specific hydropower generation since 1965
 Source: BP Statistical Review 2011 [15]

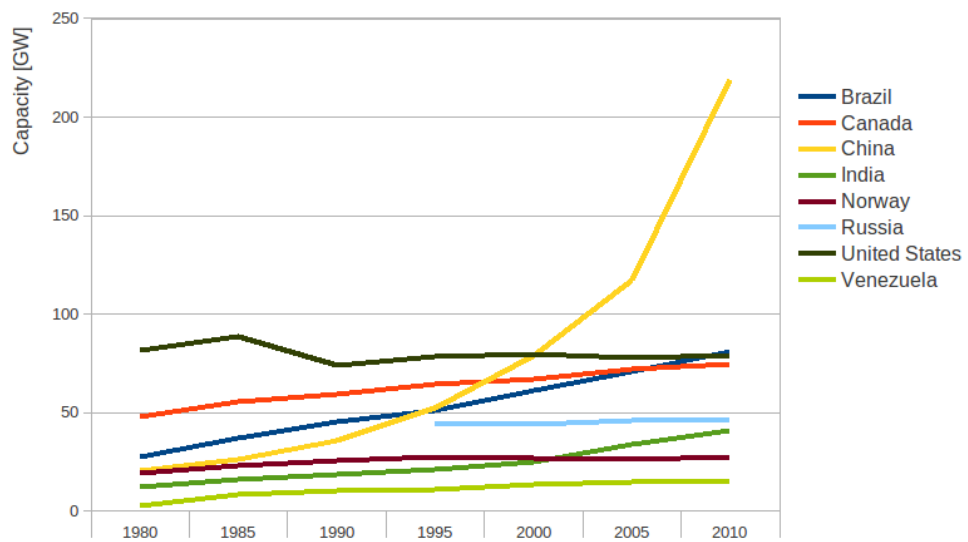

Figure 3.3: Installed hydro, selected countries [GW] (2010). Source: International Energy Statistics, U.S. Energy Information Administration [2]

ances also became relevant. In 1894 the railway system in Oslo was the first in Scandinavia to be electrified [126, p 54].

When the technology in the electricity sector developed at the end of the century, politicians in Norway started to realize the large potential of producing power from our many waterfalls¹. How to organize this development was under much discussion around the turn of the century and an important topic for the utilizations of our great potentials.

In the 1890s there was a political debate regarding the state ownership of the waterfalls. In contrast to other developing hydropower nations in Europe like Switzerland, who sought state ownership of all undeveloped hydropower, private and municipal ownership was considered to best safeguard local interests in the development of the electrical system and hydropower. There was, however, a common perception that private monopolism and speculators had to be avoided to secure a stable deliverance of electricity at a fair price. This led to a concession controlled policy which entered with the new century. Every developer had to obtain a concession given by the king to be allowed to acquire waterfalls. To get a concession the developer had to fulfil certain requirements set by the authorities. A concession could be given for a maximum number of years, and after the concession period had ran out, the waterfalls automatically would revert to the state at no charge.

In the years before 1940 there was a large expansion of hydropower capacity, mainly developed by the private sector. The Norwegian nature made it profitable to develop hydropower, even when the developers were imposed with strict concession requirements. In this way the general supply could be sustained without too much stately intervention [126].

After 1945 there was a change in policies regarding electricity supply. The main objective was, as before the war, to secure the public supply, but in addition the state now took a central role of supplying power to the growing metallurgical industry. In 1973 the international oil crisis led to a broader understanding of the importance of securing a stable supply of energy, and is believed to have played a catalyzing role in the great hydropower development that took place in Norway between 1970 and 1985. In this period 10,730 MW of capacity was developed, an average increase of 4.1 percent annually [127, 128].

The rapid development of Norwegian hydropower capacity during these years can be seen in figure 3.4. The figure also shows that the growth in built-out capacity has faded out around 1990.

¹The politician (later to be prime minister in Norway) Gunnar Knudsen, wrote a letter to the parliament in Norway in 1892 where he pointed out our potential in "countless waterfalls" to produce power and facilitate industry, like no other country in Europe [126] (also recall Bjørnson's "Absalons Hår" from 1894, see page 34).

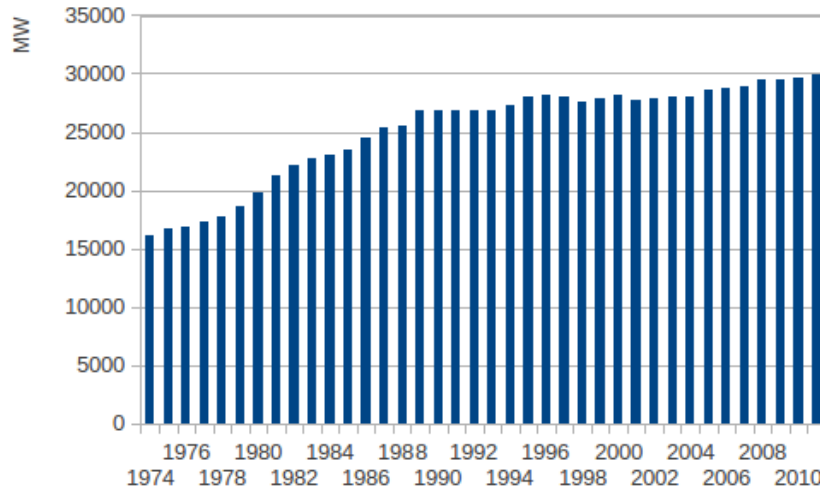

Figure 3.4: Hydropower capacity in Norway 1974 - 2010. Source SSB

3.3 Technical Potential of Hydropower

3.3.1 Global hydropower potential

According to [85, p.444-445] with reference to *The International Journal on Hydropower & Dams 2010 World Atlas & Industry Guide (IJHD, 2010)* the global technical potential of hydropower is 14,576 TWh/yr, about four times as large as the magnitude of existing generation (2009). These calculations take into account the total resource potential and what is technically and economically feasible. Figure 3.5 shows that the largest potential lies in Asia and, also, to some extent in South America, while Africa is the region with the largest share of their potential undeveloped (92 % undeveloped).

In the most developed regions, Europe and North America, where much of the resource potential is already exploited, there is still a potential of a doubling of the hydropower generation. However, further development would require upgrades of existing sites which may be old, run-down and which use technology less efficient than what is available today. Such upgrades may often be costly and how much of this untapped technical potential is economically feasible is subject to time-dependent economic conditions.

Another important factor is, of course, environmental concerns and policies which make development unwanted in many places. This is further dis-

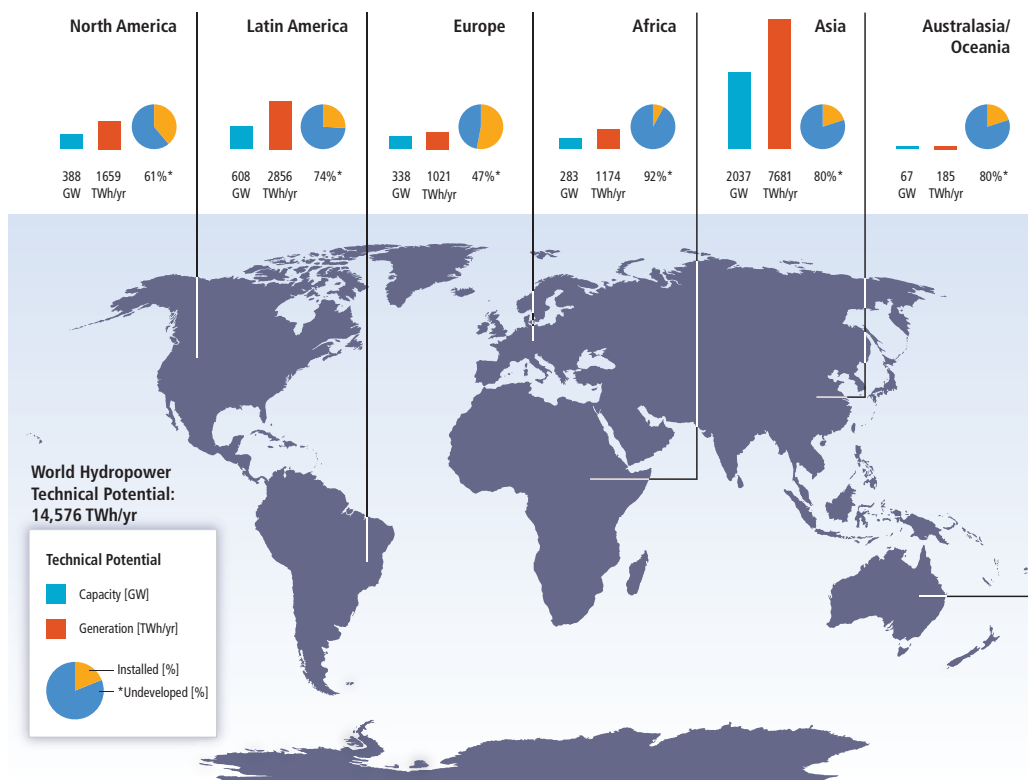

Figure 3.5: Hydropower technical potential by region. Source: [57]

cussed in section 3.6.

3.3.2 Norwegian hydropower potential

The Norwegian Water Resources- and Energy Directorate (NVE) each year makes a report on the Norwegian energy status which includes the Norwegian hydropower potential seen in figure 3.6. The figure shows that the total technical potential is calculated to be about 214 TWh, of which 130 TWh (60%) have been developed. We also see that a considerable part of the remaining potential (50.4 TWh or about 24%) has been protected by the government and will not be realized. This illustrates the difficulty of reaching the full technical potential as a quite large share of these natural resources conflicts with other concerns.

Figure 3.6 also tells us that a large share of what is left to develop resides in small hydropower plants with capacity less than 10 MW. These sites tend to require more infrastructure relative to energy output and are often therefore less profitable than the large sites developed during the 1970s and

-80s were. However, after introducing economic subsidies for development of renewable energy in January 2012, so called "Green Certificates", it is expected that more of these economic marginal sites will be developed in years to come. This trend is already felt as the number of applications for concessions has increased in recent years. The "Green Certificates" will be further discussed in chapter 5.

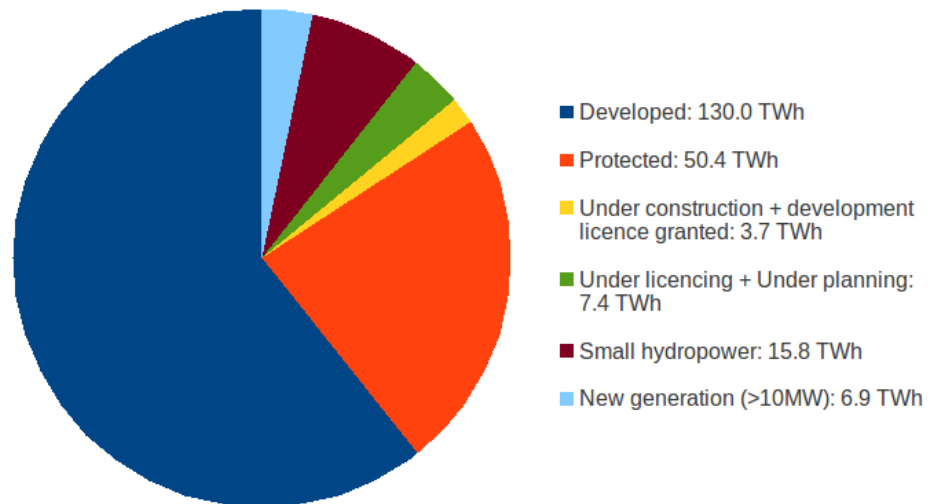

Figure 3.6: Overview of average Norwegian hydropower consumption, and economic- and technical potential. Source: [96].

3.3.3 Upgrades and expansions of existing sites

A significant part of the remaining Norwegian undeveloped potential of hydropower generation lies in upgrades and expansion of existing sites (both small scale and large scale). According to the Norwegian Water Resources- and Energy Directorate (NVE) the *theoretical* potential is about 15 TWh/yr, while the *economically justified* potential is estimated to be 7.4 TWh/yr [95, 82]. Upgrades of existing sites (many of them are about 50 years old) can involve expansion of the cross-section of waterways to reduce the dissipation and corresponding head losses, or replace old turbines and generators with new ones to enhance the efficiency. Such upgrades require temporary shut-down of production, which gives uncertainties in the profitabilities of such investments. Therefore, it is believed that projects that involves both

upgrades and expansion, i.e. that can increase water intake area and/or increase the reservoir sizes, account for most of the potential.

Upgrading and expansion of existing sites already regulated for hydropower purposes, may in many cases be prioritized in the development to come, as such projects are often associated with less environmental issues than the development of many new small scale hydropower schemes.

3.4 Classification of Hydropower Schemes

Depending on hydrological characteristics, hydropower plants are classified in different ways. The different types serve different purposes for electricity generation and demand-meeting power production. Run-of-river hydropower projects are schemes with little or no ability of water storage, while reservoir type projects have significant storage capacity. In addition there are pumped-storage schemes with capability of pumping water to an upper water reservoir for storage purposes. The plants are also classified by size and power output.

3.4.1 Classification by head and size

The head of a plant is the difference between the upstream and downstream water level. The available head determines the pressure in the turbine which together with discharge are the main parameters for deciding the type of hydraulic turbine to be used. The classification of what should be considered as low, medium and high head varies widely from country to country so no general scale exists. However, it may be convenient to separate between the plants according to which type of turbine that should be used. Generally Pelton turbines are used for high heads, Francis for medium heads and Kaplan or Bulb type turbines are used for low heads [85].

As by head, the classification of hydropower plants by size in terms of installed capacity, varies widely between different countries. Norway (and also numerous other countries) defines "small" hydro as < 10 MW, "mini" as < 1 MW and "micro" as < 0.1 MW installed capacity. Other hydropower nations use different values for defining "small" hydro, like China (< 50 MW), Brazil (< 30 MW), Sweden (< 1.5 MW), and many others. It is common to consider all plants greater than the country's definition of "small" as "large", while plants on the GW scale (like the world's largest, the Three Gorges with 22.5 GW) are often referred to as "very large" [85].

Classification by size might be important within a country for example in terms of legislation². However, a common international classification by

²In Norway, rivers and waterfalls containing a possible capacity of more than 4000

size is not particularly useful as consequences and impacts (for example environmental harm) caused by hydropower schemes is not linearly dependent on size. Also, although one "small" plant often causes less harm than one "large" plant, the consequences per unit energy generated might be greater with several small plants than with one large [9, 4].

3.4.2 Run-of-river type hydropower

Run-of-river plants utilize the flow of water within the natural range of a river, i.e. they have no storage capabilities. Therefore little or no impoundment is needed. Typical run-of-river projects are often situated at either large rivers with gentle inclination, using large flow rates and low heads, or at steep waterfalls with high heads but small flow rates.

Run-of-river projects serves base load electricity generation to the power net, as they have little ability of storing water and regulating power output. The power delivered to the net will thus be directly dependent of flow rate and water level of the river.

As a natural river flow will vary quite much with the weather and seasonal fluctuations, run-of-river hydropower plants will need technology which can handle such fluctuations. The turbines, for example, must be designed to produce power efficiently over a large range of flow rates. Alternatively different turbines are installed, operating at different times of the year.

A benefit with run-of-river schemes is that they often cause less environmental harm compared to reservoir type hydropower as they don't require dams. Run-of-river schemes therefore don't change natural flow regimes and don't affect the nature in the same magnitude as schemes with impoundments. It is also often easier to create fish passages, and safeguard aesthetic concerns (for example by keeping waterfalls), by merely utilize portions of the river and let the remaining flow as normal.

3.4.3 Reservoir type hydropower

Reservoir type hydropower schemes are characterized by their ability to store water using some sort of impoundment to create magazines. As of this, these plants are able to deliver both base load and peak load power production to the power net. By storing the water in the reservoir when there is a low demand for electricity, and generate on full capacity when there is a power

horsepower (about 3 MW) are subject to law of acquisition of waterfalls from 1917, so that developers have to be granted concession before making interventions at such sites [80].

shortage (peak demand), these hydropower schemes represent a valuable resource for the electricity net.

Reservoir type hydropower may be used as pumped-storage sites by pumping water from a lower reservoir to a reservoir at a higher level. As energy storage and power balance probably will be more important in a future energy system, pumped-storage hydropower is discussed in more detail in the following section.

3.5 Pumped-Storage Hydropower and Need for Grid-balance

3.5.1 Power fluctuations and stability

Since energy cannot be stored in the power net, the relatively large variations in power consumption have to be accounted for by instantaneously varying generation. If the generation fails to follow the demand, the voltage frequency in the power net deviates from the normal value (50.00 Hz in the Nordic net (Nordel) and Europe, 60 Hz in North America). Such deviations cause damage to electric devices and could in worst case cause cascading failure and system breakdown. The transmission system operator (TSO) of the different countries (Statnett in Norway) has the responsibility of securing a stable frequency at all times [70].

Figures 3.7, 3.8 and 3.9 show demand curves for random time periods in the Norwegian power net, respectively on a one day, one week and three years time-scale [115]. Figures 3.7 and 3.8 show that the consumption of energy varies with about 5 GW, or about $\pm 10\%$, between night and day, with demand peaks especially around 08:00 (shower, breakfast and industry start up) and between 17:00 and 19:00 (dinner, TV, etc.). The daily rhythm is most apparent from Monday to Friday, while it smears out in the weekends. In figure 3.9 [112] the seasonal variations over a three year period is drawn, showing a more sine wave-looking demand pattern between the seasons with nearly twice as much power consumption during the winter months than mid-summer.

In figure 3.10 the power generation in Norway is plotted in red on top of the blue demand curve for the same week. What we see is that generation exceeds consumption during daytime, while the opposite occurs during night. That indicates that over this randomly picked week, Norway is exporting power to neighbouring countries during the day, and imports during the night. This is a typical power flow in the Nordel system, and shows the balancing ability of reservoir type hydropower. Norwegian hydropower

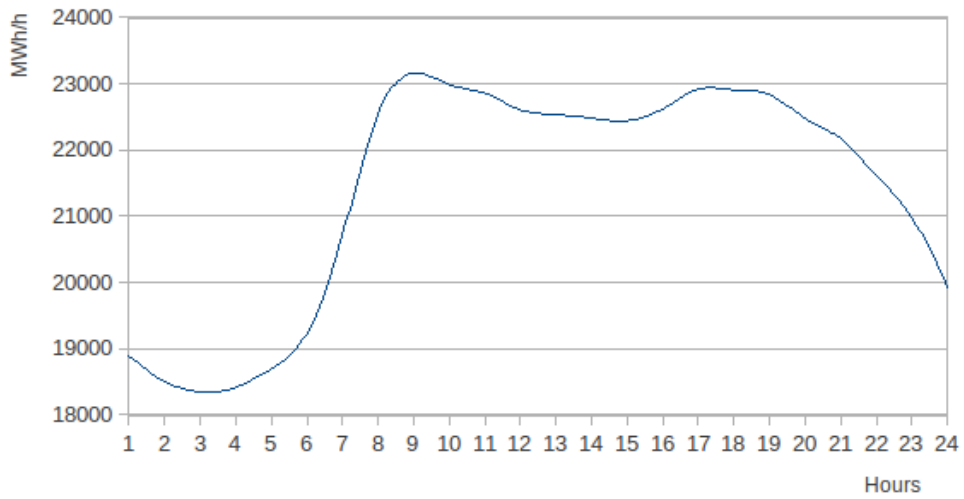

Figure 3.7: Norwegian hourly power consumption on a typical day (Tuesday 15.1.2013). Source [115].

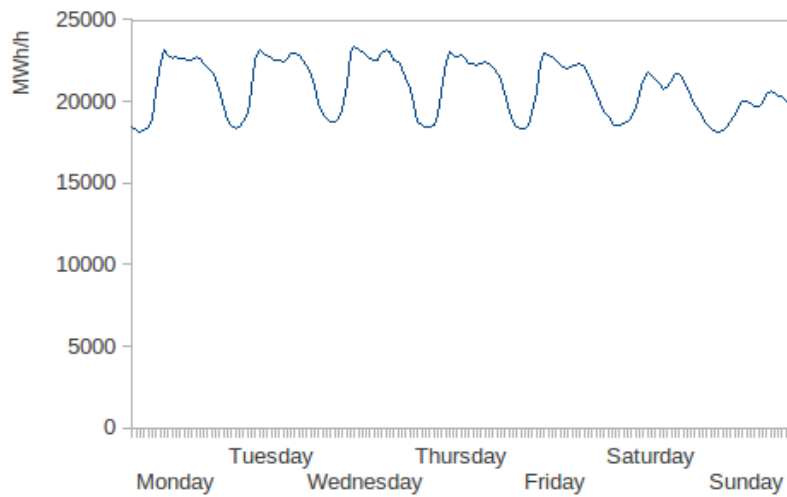

Figure 3.8: Norwegian hourly power consumption during a typical week (Monday 14.1.2013 - Sunday 20.1.2013). Source [115].

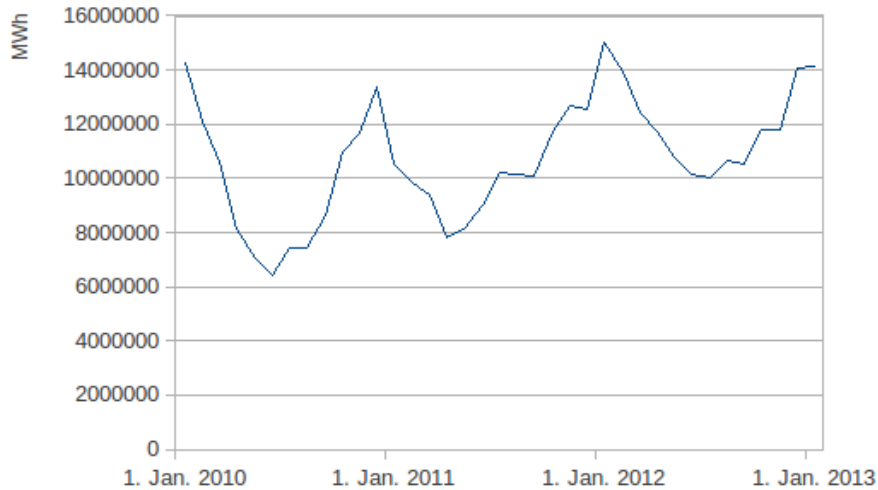

Figure 3.9: Norwegian monthly power consumption 2010-2012. Source [112].

provides peak power not only within the country, but also for neighbouring countries, while cheap base-load electricity from wind farms in Denmark or thermal and nuclear plants in Sweden/Finland is imported at night.

Figure 3.11 shows import (blue) and export (red) of electrical power over three years. In the first half of the period, Norway imported more than it exported, while in the last couple of years the trend has been the opposite. This shows that reservoir type hydropower has significant seasonal fluctuations and is highly dependent on weather and inflow (rain). Therefore, some power exchange with neighbouring countries is beneficial for both parts; for covering daily fluctuations e.g. in Denmark, and seasonal fluctuations in Norway.

3.5.2 Need for energy storage in future renewable energy systems

To manage fluctuations in the power net in a future energy system with a large share of intermittent renewables, is one of the greatest challenges associated with such a system. The peaks in power consumption, like those shown in figures 3.7 and 3.8, are expected to increase as power consuming devices are being used more extensively by an increasing number of people. Additionally, large variations on the production side are going to occur when

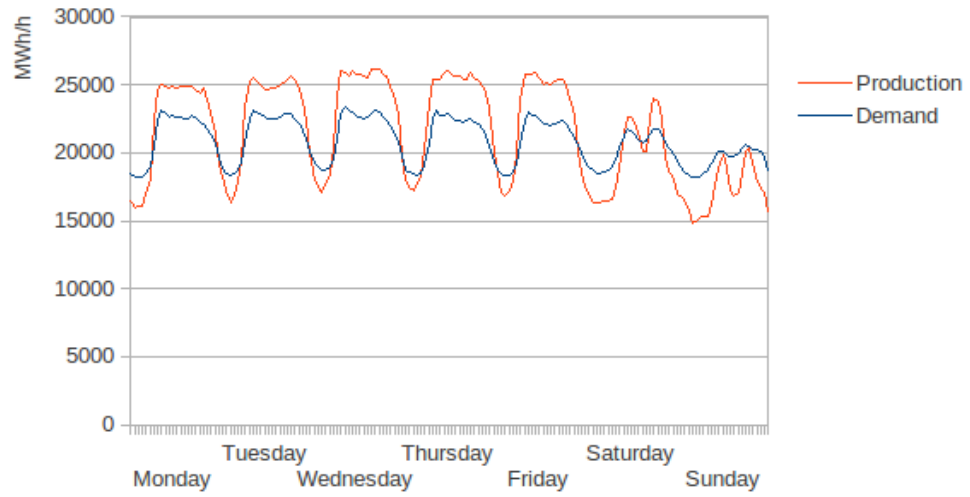

Figure 3.10: Norwegian hourly power consumption (blue) and generation (red) during a typical week (Monday 14.1.2013 - Sunday 20.1.2013).

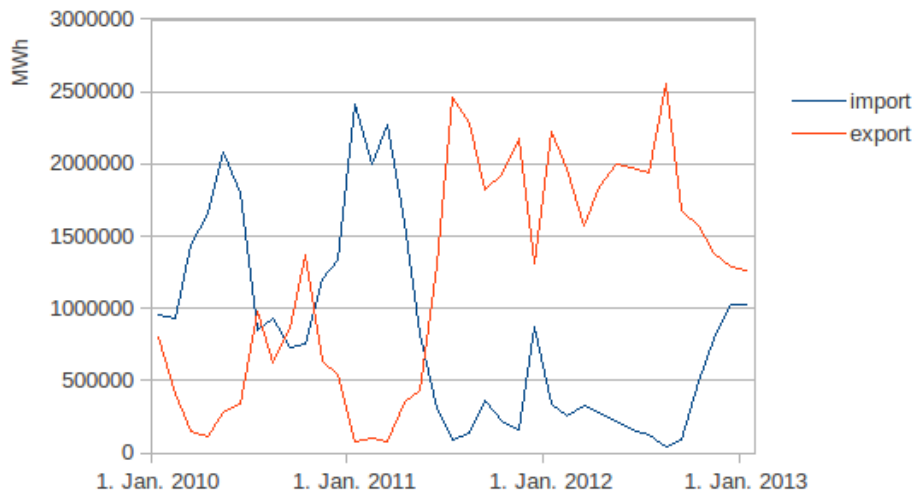

Figure 3.11: Norwegian monthly power import (blue) and -export (red), in 2010-2012.

introducing the intermittent sources. Power production from solar PV is affected by clouds, and is absent at night-time, while wind power does vary at different time scales. Although the effect of having units spread over a large area, together with a well-developed power transmission system, could reduce the variations somewhat (as there always is some wind somewhere), there will be hours when all the wind power in entire countries suddenly drops, and also periods of several days with nearly no generation [64]³. It will therefore be a large need for managing the quick up- and down ramping in either generation or demand (or both at the same time), and to have enough energy for the longer lulls of low power generation. The ability of storing the energy from sunny days and times of strong and steady winds, will therefore be of high value in the future.

What the actual balancing needs are in future renewable energy systems, will depend on several factors and is therefore hard to estimate. According to [26], Europe's solar- and wind power capacity could already in 2020 be as large as 330 GW, part of which will have to be balanced at certain times. Targeting a power sector supplied 100% by renewables in 2050, its obvious that the needs will be tremendous. Although controlling generation from various sources, and balancing the demand side according to available power, could cover some of these needs, a significant amount of power and large amounts of energy will have to be covered by storage.

The importance of energy storage should thus not be underestimated. The cost of renewable energy technology is often compared to those of fossil fuels and the price of electricity in today's market. One has to bear in mind, though, that fossils are all energy resource, energy storage, and energy carrier in one. Therefore generation, transmission as well as storage has to be accounted for when comparing renewables to traditional fuels, and evaluating costs and profitability.

To realize the ambition of a future renewable energy system, the topic of energy storage, both small scale storage, transportation and large scale storage (grid storage), is essential. Being the only large scale energy storage technology technically viable, pumped hydro storage will certainly play a vital role in such an energy system.

³In northern areas, periods of several days during winter, with low temperatures, few hours of sun and no wind, will be the hardest to handle as they coincide with high demand.

3.5.3 Status and global development of pumped-storage hydropower

Pumped-storage hydropower, or pumped hydro storage (PHS), is the only mature technology used for large scale renewable energy storage, covering more than 99% of worldwide bulk storage, according to The Electric Power Research Institute (EPRI) [28]. The idea of pumping water for storage purposes is not new. The first use of pumped hydro storage was in the 1890s in Italy and Switzerland [136].

In 2010, according to [2], the total installed capacity of pumped hydro was 120.7 GW, with Japan as the most developed country with 25.4 GW, followed by USA with 22.2 GW developed⁴. China comes third with 15.3 GW, but while USA and Japan have had a relatively steady pumping capacity the last 10-20 years, China has tripled its capacity since 2004. In the EU, 38 GW of pumped hydro capacity [22] (44.6 GW according to [2]) has been developed. Austria has the largest share of its generation represented by pumped storage with about 18.7%, Japan has 10.2% while USA has 2.2% [85]. Installed capacity by country in 2010 is presented in fig. 3.12.

The world's five largest pumped hydro storage facilities are Bath (USA, 3003 MW), Huizhou (China, 2448 MW), Guangdong (China, 2400 MW), Okutataragi (Japan, 1932 MW) and Ludington (USA, 1872 MW) [136].

It is believed that the world wide installed capacity could increase with as much as 60% within a few years, reaching about 200 GW [123].

3.5.4 Pumped hydro in Norway

Norway has installed just over 1 GW of pumped-storage capacity with Saurdal Kraftverk in Suldal, Rogaland, being the largest with 320 MW of pumping capacity (640 MW in turbine mode). The plant has two regular Francis turbines and two reversible Francis turbines. The pumps can pump water 465 m from a lower reservoir up to the Blåsjø magazine, Norway's biggest reservoir in terms of energy (7777 GWh) [59]. In 2012 the yearly consumption of pumped hydro in Norway was 1470 GWh [91].

Unlike in most other countries, Norway uses pumped hydro mainly for seasonal storage. This is due to Norway being in the unique position of having nearly 100% of its electrical power supply coming from hydropower,

⁴Different sources vary quite much in estimating pumped hydro capacity. Some, for example [28], [123] and [136], use 127.0 GW as global developed capacity. Also, [2] list the grand hydropower nation India, with no pumping capacity while the Government of India's Ministry of Power [75] claims to have 4335 MW developed with additional 475 MW under construction (2008).

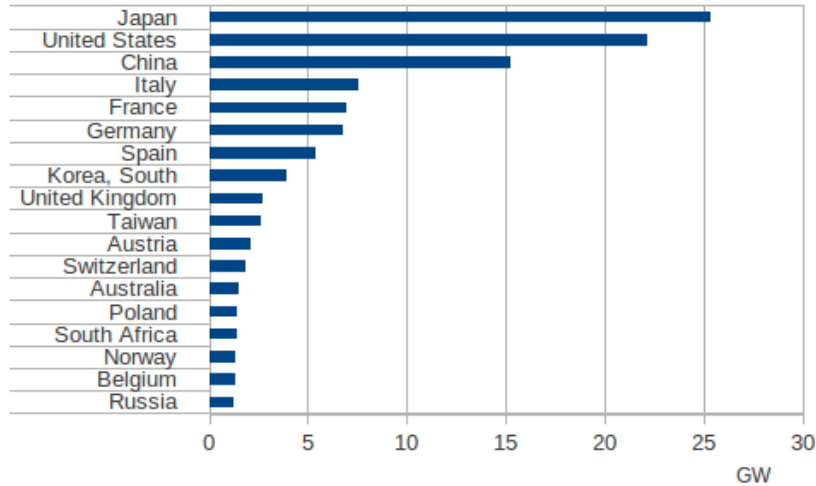

Figure 3.12: Installed pumped hydro, selected countries [GW] (2010). Source International Energy Statistics, U.S. Energy Information Administration [2]

and with a large share of reservoir type hydropower. Therefore, as we've seen, daily fluctuations in demand are fairly easily met by controlling discharge and power output from some of the hydropower plants with reservoir capacity. What is needed of pumping is to keep a relatively steady reservoir water level throughout the year, so that the reservoirs don't run empty in the winter.

In other countries with a large share of its power generation coming from sources that are not as flexible as hydropower when it comes to varying power output over short time periods (like coal, oil and nuclear plants), pumped hydro storage and what little they have of reservoir type hydropower is needed to meet daily variations in demand. Seasonal storage of hydropower is not needed as these long term variations can be met by adjusting base load power generation from e.g. fossil fuels.

Although not much pumping capacity has been developed, Norway, with its many water reservoirs, has large potentials for pumped hydro storage. In total, the Norwegian reservoirs have a storage capacity of 85 TWh (62 km³), which corresponds to nearly 70% of annual inflow in Norway (123.5 TWh (2010)), and to about 50% of all hydroelectric storage capacity in Europe [119]. Using these reservoirs to balance fluctuations in a European power system like a "green battery", is a debate that has arisen the last few years. Thus, the Norwegian Water Resources and Energy Directorate (NVE) has started an ongoing research trying to map Norway's potentials for pumped-

storage hydropower, and possible consequences related to it. In a report published in 2011 [1], the costs (economic) of turning existing hydropower plants into pumped-storage plants using existing reservoirs and regulated flowrates etc. were investigated. Four different sites were studied, varying from 18 to 1500 MW, finding that the cost per MW is clearly largest for small installations (<200 MW). In another preliminary study performed by Eivind Solvang, Atle Harby and Ånund Killingtveit (CEDREN/Sintef) [111], it is estimated that the Norwegian balancing power capacity could be increased by 20 GW by installing new hydropower plants (some pumped hydro) in existing reservoirs regulated for hydropower purposes.

The idea of Norway as "green battery" for Europe is further discussed in chapter 5.

3.6 Impacts of Hydropower Development

Different environmental- and socioeconomic issues related to hydropower development are, as we've seen, one of the main reasons why reaching the full technical- and economic potential of hydropower is difficult to achieve. Both within countries, and regarding cross-boundary basins, there are a multiple of concerns needed to be safeguarded in order to have a sustainable development. International cooperations in e.g. International Energy Agency's (IEA) *Hydropower and the Environment*-project [3], and *The World Commission on Dams* [100, 86], have created common guidelines and recommendations for hydropower- and dam development, which many countries' legislation is based upon. However, possible climate change and water scarcity will increase the need for cooperation and cross-boundary planning regarding hydropower and water uses. In this section, an overview of different environmental- and socioeconomic impacts is given, with some examples from the Norwegian development, as well as from the Three Gorges project in China. The last section of the chapter is dedicated to the significance of water as resource, with basis of hydropower development in the Himalaya region.

3.6.1 Environmental impacts

Like most energy and water management options, hydropower development and dam constructions are associated with a considerable environmental footprints. The impacts are, however, highly site specific, and dependent on factors like the size and type of the scheme, as well as regional climate conditions. It's important to note that hydropower development may have both

positive and negative impacts.

Sedimentation occurs when an increased number of sediments in the flow (particles of minerals, soil, dirt, corrosion, etc.), are given enough time to sink to the bottom and stack up. The transport of sediments in a water flow is dependent on factors like the slope, current velocity and water depth of the river. If e.g. the the velocity is reduced by damming up the water, it could lead to increased sedimentation in the reservoir, which reduces the storage capacity and changes the transport of sediments downstream of the dam.

A change of the hydrological regimes, as well as impacts on Nature due to infrastructural needs for hydropower development, may also influence different kinds of *biodiversity* in contact with each specific site. The affect on e.g. terrestrial and aquatic flora, transportation of fish eggs and plankton, possibility for fish passages, mammals and birds in the surroundings of the affected sites, all have to be evaluated before developing a scheme, or creating a dam.

Hydropower development may affect *climatic conditions* like temperature, wind, evaporation and precipitation. As water has high heat capacity, the construction of large reservoirs will act like a thermal storage site, which could change the temperature of the water flow and the surroundings. Open reservoirs may also reduce the wind friction with the ground, and evaporation rates will be changed if water is led into magazines, instead of being spread over larger areas.

There may at some locations be an *induced seismic activity* due to the isostatic pressure generated by impounding a reservoir. According to [3], several *earthquakes* are known to have been caused by reservoirs. *Landslides* is another type of impact that can arise after damming water, or as a consequence of earthquakes. In the Vaiont Dam in Italy in the 1960s, a landslide created a wake (said to be 100 m high) that flushed over the village of Longarone and killed over 2000 people [3].

Change in *water quality* in reservoirs and downstream of reservoirs, is another important possible environmental impact. Especially in large magazines, stratification will occur due to variations in temperature, density and salinity. The hindrance of vertical mixing may affect the dissolving of oxygen, ph, the color and amount of nutrients in the water, which may further affect the chemical quality of the water downstream. If the outlet is in an estuarine, the altered properties of the water may affect the estuarine environment in the interaction between fresh water and sea water.

3.6.2 Socioeconomic impacts

To predict and to determine all socioeconomic impacts of a hydropower project is very difficult, but includes both advantages and disadvantages. The total impact is often a complex mixture of direct- and generic-, short- and long-termed impacts, some irreversible.

The most obvious, direct, and probably most sensitive socioeconomic impact of (large) hydropower projects is the issue of *resettlement* and *rehabilitation*. The involuntary displacement of people has turned out to be the largest source of resistance to hydropower development, where due to insufficient legislations, funding and planning methodology, proper rehabilitation has often been less than successful. Resettled people are also often relatively poor and vulnerable, with little power to defend their rights. History has shown several incidents where farmers and ethnic groups have been simply forced by national or international developers to move to new territories [3].

By their very nature, hydropower projects generate a significant amount of long term impacts on existing and future *land uses*. In upstream, reservoir, and downstream areas, as well as along rivers, changed water levels and flow regimes can affect (positively or negatively) e.g. fishing resources, agricultural activities, other industry related to river flow, and accessibility. Additionally, it has been debated whether hydroelectric generation is merely an in-stream water user or whether it also *consumes* water, in the sense of effectively taking away water from the river. Estimates give indications that the so-called *water footprint* of hydropower is high, due to evaporation from reservoirs [67]. This possibility introduces conflicts between hydropower and drinking water, which cannot be taken easy upon in impact assessment planning for hydropower projects.

There are certainly also a number of direct and indirect *economic benefits/costs* associated with hydropower projects. Aside from the improved power supply, which may stimulate growth locally, regionally and nationally, the most important economic benefits that frequently apply to hydropower projects are flood control and river flow regulation, irrigated agriculture, and water supply [3].

Hydropower development and dam construction is also associated with several *health and safety* impacts. The spreading of *diseases* may increase due to connection of hydrological systems and increased population. To ensure *flood control* is important for the safety conditions downstream of a dam, and may often be the main motivation for the development. However, in the eventuality of dam failures, the consequences could be dramatic, as flood control often leads to increased population downstream of the dam. Risk of *earthquakes* and *landslides* are other potential safety issues.

Various types of *social impacts* related to hydropower development and increased power supply involve impacts on cultural heritage, ethnic groups, demography and way-of-life. The value of having available undisturbed nature for recreational purposes, with aesthetically pleasing waterfalls instead of hydropower plants, is a common good that is hard to quantify and compare with economic profits.

Hydropower may also have impacts on geopolitical issues, as we will discuss in section 3.7.

3.6.3 Increasing resistance to Norwegian hydropower development in the 60s, 70s and 80s

Prior to the 1960s, in the post war rebuilding of the country, the development of hydropower was more or less exclusively seen as something that was positive for general welfare of local communities in Norway. However, in the 60s hydropower development started to face some controversy. Protection and conservation of Nature was to a greater extent put on the agenda. Before, nature conservation was limited to preservation of waterfalls of aesthetic value, and to protection of different unique biological species. In this period this changed to include whole ecosystems and also highlight the value of nature in a social perspective. Because of this, wider considerations had to be accounted for in planning efforts, with increased involvement of different interest groups and environmentalists [128, p.70-90].

In 1970 in Mardøla, civil disobedience was used for the first time against hydropower development in Norway. About 500 people, both conservationists and locals, blocked and camped in the roads up to the construction sites to show their opposition. The reason for the protests were both environmental, preservation of Northern Europe's highest waterfall "Mardølafossen", but also socioeconomic as there were plans that included leading water away from the local community of Eikesdalen, which would have negative consequences for agriculture, industry and infrastructure there. In an area that already was suffering from depopulation, this was not easily accepted [128, p. 90-95].

The most important and famous case of Norwegian history in resistance to hydropower development, is the "Alta-case", protests against damming of the Alta-Kautokeino river in the northern part of Norway in the 70s and 80s. In the early stages of the planning, it was suggested damming of a small village called Masi which would, however, harm the Sami minority. Although this proposal was later withdrawn from the plans, the case got much attention and resulted in massive protests. A protest camp was set up being visited by over 6000 people in the summer of 1979. In 1981, 1000 demonstrators

confronted 600 policemen at the construction site. In addition a hunger strike was performed outside the parliament in Oslo and also in Stockholm, and in 1982 demonstrators attempted to blow up a bridge using dynamite [128, p. 150-156].

3.6.4 "Monstrous masts"

The "monstrous mast"-debate in Norway regarding construction of power transmission lines between Sima and Samnanger in Hardanger, generated some popular revolt and lots of media coverage when it was on its peak in 2009-2011. The transmission lines are to be held up by a total of 275 electricity pylons⁵, ranging from about 20 - 40 meters high. The pylons are being set up in the mountain areas along the Hardanger fjord, an area of natural beauty which has been a tourist attraction for more than a century. The development is part of the large power grid upgrades that are taking place now and will go on in the next ten years (see section 5.2). It was delayed several months because of the protests. The construction work of the 92.3 km long line, is planned finished by the end of 2013.

Opponents against the masts claim that cables should be put on the sea floor instead, despite the extra costs and the considerable depth (down to 800 meters). The developer Statnett, on the other hand, backed by a majority of the politicians of the parliament, refers to several assessments that concludes that sea cables will be hard to maintain and unprofitable, and that pylons of the same size already exist throughout the country.

If anything, the debate illustrates that development and upgrades of the power transmission grid is a time-consuming activity, with long concession processes and possible delays even after permission has been granted.

3.6.5 The Three Gorges

Most of the environmental and socioeconomic impacts discussed in this section are apparent in the world's largest power project The Three Gorges Dam, located in the Yangtze River in China. Apart from having an installed capacity of 22.5 GW, delivering nearly 100 TWh of clean renewable energy each year which otherwise would have been coal fired, the dam has its main purpose in providing flood control. In 1931 a flood in the Yangtze killed 145,000 people (some say the number could be more than 3 million) and left 28 million homeless [121]. In 1954 a new flood killed over 30,000, and nearly 4000 were killed as late as in 1998, leaving 15 million homeless.

⁵The pylons were given the Norwegian name meaning "monstrous masts", which also became the name of the debate

The plant was fully operational in 2012, and has implied several impacts [39, 121], huge resettlements and excessive landslides probably having the largest consequences. A total of 1.4 million people have already been forced to move, a number that could rise to nearly 4 million people [140, 121]. Since 2010, when the water reached the designated level of 175 m, officials have recorded 430 landslides and nearly 2,900 smaller geological incidents along the lakeshore [140]. A 2003 landslide killed at least 14 people, while a 2007 slide buried a bus, killing 31.

Criticism about the various consequences of the scheme, especially about the conditions of the resettled people, is suppressed in China [121]. One can wonder if such a project would have been feasible in a democracy without Chinese Confucianism.

3.7 Significance of Water as Resource

Access to drinking water is a premise for most human activity. Unfortunately water is a limited resource and as the world population is growing rapidly, access to fresh water is more difficult to achieve for an increasing amount of people. The United Nations states that 1.2 billion people live in areas of physical scarcity of water. Another 1.6 billion face economic water shortage caused by countries lack the necessary infrastructure to bring water from rivers and aquifers. Water use has been growing at more than twice the rate of population increase in the last century, and, although there is no global water scarcity as such, an increasing number of regions are chronically short of water [72].

It lies in human nature to fight for survival. Therefore it may be understandable that regions with lack of access to basic needs like water tend to be areas of unrest filled with conflict. As UNs secretary-general Ban Ki-Moon said [72]:

”All are places where shortages of water contribute to poverty. They cause social hardship and impede development. They create tensions in conflict-prone regions. Too often, where we need water we find guns. [...] There is still enough water for all of us - but only so long as we keep it clean, use it more wisely, and share it fairly”

There is a concern that in the next decades the world will witness an increase in the amount of water conflicts as water supply are unlikely to keep up with global demand [98]. North Africa, the Middle East and southern/-central parts of Asia are regions experiencing water shortages. These areas

are also believed to see the most increase of stress due to water scarcity in years to come as a consequence of population growth, energy demand and also, possibly, climate change which could make these areas dryer than they are today.

Already, the world has seen examples on conflicts related to water, so called water wars, either as the underlying cause or as contributing factor, often combined with (or perhaps hidden behind) other issues like religious disputes [43]. The Jordan River, which Israel, Syria, Lebanon, Jordan and the Palestinians are dependent of, has been a source of dispute in an area filled with conflict. Ariel Sharon stated that the "Six Days war" against Syria in 1967 was purely water based. It is also believed that Israel's occupation of the Golan Heights is for securing water supply, while others claim it is for military strategic reasons only [46].

The utilization of cross boundary basins like for example the Nile River, the Tigris-Euphrates and rivers in the Himalayas; Brahmaputra and Indus, could also experience renewed tension in the following decades. It is, however, not believed that direct water wars will occur in these areas already in the next ten years, but that the risk of conflict will grow as water demand is set to outstrip sustainable current supplies by 40 per cent by 2030 [7]. It is believed that conflicts within nations are more likely to arise in the short term as tension rise between thirsty inhabitants, opportunist politicians and profit seeking companies.

3.7.1 Hydropower in the Himalayas

In the Himalayas, several nations are planning to utilize hydropower potential from rivers that flow through different countries. In an area which has been the site of conflicts and disputes for many years, e.g. about borders between influential countries like China, India and Pakistan, cooperation and talks between countries about trans-boundary waterways may not be easy to achieve. India, which has developed about 40 GW hydropower capacity (about the same as Norway), aims at a major development in years to come, planning towards reaching their full technical potential of 148 GW within the next several decades [75]. By 2030 the Government of India aims at constructing 292 dams throughout the Indian Himalayas which will, if all proposed dams are constructed, make the area have one of the highest average dam densities in the world, with one dam every 32 km of river channel [37]. These mildly speaking ambitious development plans are due to the 400 million people in India without access to electricity. In addition, India is greatly dependent of fossil fuel imports and is expected to double their carbon emissions by 2030 [16]. This will, if prices on emissions increase, make

hydropower an even more valuable source of power. Another important aspect is that the involved countries, all with undeveloped hydropower, are eager to start building sites to gain "prior appropriation" of water resources before neighbouring countries build dams. As a consequence the speed of development often is prioritized before thorough planning, and may lead to serious environmental harm and consequences for agricultural water use [37].

The two most important river basins in India are the Brahmaputra and the Indus rivers that begin in the Tibetan Plateau (China) and flow into Bangladesh and Pakistan, respectively. With China also eager to develop hydropower and construct dams, this could significantly influence the flow downstream and have consequences for the other countries. As China and India have a combined population of 2/5 of the world's population, a conflict in this area could obviously have severe impacts. Negotiation and cooperation between the countries is therefore extremely important with respect to regional security. It is also believed that any single nation's development cannot be optimized without trans-boundary river basin planning.

3.7.2 International society's role

Water supply and utilization of fresh water, especially in areas with water scarcity, is seemingly being put more and more on the agenda of international politics. After the release of the report "Global Water Security" [7] by the office of the US Director of National Intelligence in March 2012, Hillary Clinton said "These threats are real and they do raise serious national security concerns" [46]. Another report [87] states that "Water scarcity is often overlooked, underfunded, and undervalued within foreign policy. Yet a government's ability to provide and manage access to water is critical for ensuring political, economic, and social stability." Further the report concludes with four recommendations on how United States' foreign policy should be formed regarding water scarcity in Central and South Asia. The recommendations involve providing benchmark data to improve water management, contribute to knowledge of effective water management, deliver holistic solutions of utilization of water for international regions (i.e. not only provide aid for specific countries, exemplified with Pakistan in this report, but for entire regions affected by a water basin) and help developing strong, sustainable cooperative institutions to safeguard against shocks to water supply and demand (for example natural disasters or terrorist attacks).

Even though this report is limited to U.S. foreign policy in a specific area, these recommendations may be generalized to how the international community could help stabilizing areas of political tension caused by water scarcity. A nation like Norway, with long traditions for utilizing water,

could for example provide data collecting and monitoring techniques, assist with services regarding environmental concerns and help establish cooperative multinational institutions for optimal utilization of trans-boundary water basins. Norway has much experience with cooperation over trans-boundary watercourses and has developed multiple agreements and treaties with neighbouring countries [79]. As 97 % of all water in the world is salt water, more intensive research on desalination of water could also be a possible way for rich countries like Norway to contribute towards solving the water scarcity problem.

There are a number of examples of Norwegian power companies having international activities. The Bergen-based power company BKK has had engagements in Nepal since 2001 through ownership in Himal Power Limited (HPL), together with SN Power Invest, and the local company Butwal Power Company Limited. HPL owns a hydropower plant called Khimti 1 (60 MW), operational since 2000, and is now planning on developing another (67 MW). The last couple of years the activity of HPL, along with the Norwegian government, has contributed to the development of a school and a health clinic, as well as providing power for the local community [13]. BKK, SN Power Invest, Norfund and Trønder Energi also established the power company Agua Imara in 2009. Through activities in Zambia, Mozambique, South Africa, Costa Rica and Panama, the company is hoping to realize 700 MW of renewable power generation in 2015, and contribute to local growth and development [13].

It is possible that above mentioned reports indicates an increased focus on stabilizing areas by securing access and optimal utilization of basic natural resources like water. Perhaps we are witnessing a shift in global security politics from military assistance against various riots towards a new form of Marshall Aid where the rich help the poor develop sustainable resource management and energy supply.

3.7.3 Further development

Media sometimes highlight drawbacks for hydropower by stressing that "more people die from accidents related to hydropower than from nuclear energy in total". Likewise we can also draw comparisons between increasing risk of water wars and the danger of nuclear weapon proliferation, as well as comparing hydropower's effect on agriculture to the discussion of using fertile soil for biofuel production instead of growing food.

By establishing multilateral energy partnerships between countries it is possible to minimize these drawbacks in hydropower production. By performing thorough risk analyses one can reduce the number of accidents related

to hydropower. Cooperation between nations can help optimize production and reduce the risk of disputes. By research and careful planning, environmental harm can be reduced and holistic utilization of water resources can make the impact of dams on agricultural water needs positive⁶. Without this kind of cooperation and planning, utilization of Asia and Africa's great hydropower potentials will be problematic if not impossible to develop without the consequences being intolerable.

⁶As hydropower in principle utilizes the flow of water rather than water itself, this should be possible to achieve. Good planning can lead to less water being lost e.g. to evaporation.

Chapter 4

Tidal Energy

4.1 Status of Tidal Power

Tidal power is today only at a preliminary phase and does not contribute with any significant share of global electricity generation. Apart from a few schemes like the La Rance plant in France (240 MW) and Sihwa Lake Tidal Power plant in South Korea (254 MW), most tidal power plants are test sites and pilot projects and are not yet profitable. However, in recent years, tidal power has been given increased attention as a renewable energy resource. It has the great advantage that it is fully predictable, opposed to intermittent renewable energy sources like wind and solar. Therefore, tidal power is able to provide stable electricity generation to the power net since no periods of *unforeseen* lack of power generation occur. As there will be a greater demand for such predictable energy sources when more wind and solar are introduced to the power grid, it could well be that tidal power has a bright future with technology to meet a growing market within a few years.

A number of innovators and also policy makers in certain regions have started to position themselves towards this scenario. In Norway companies have been established (e.g. Tidal Sails, Hydra Tidal, Flumill, Hamarfest Energi, Aqua Energy Solutions, TideTec) in the last decade or so, developing and optimizing technologies for power extractions from tides. The Norwegian Water Resources- and Energy Directorate (NVE) has granted some of these companies concessions to deploy pilot projects and prototypes for research and testing purposes [94]. In 2003 Hammerfest Strøm AS installed a test site in Kvalsundet, Hammerfest in the north of Norway with a capacity of 300 kW, which was the first tidal current turbine delivering power to the grid. Hydra Tidal is working with the world's first floating water current turbine, Flumill has been given concession to test their spiral shaped, Archimedes

Screw-turbine in Ryastraumen, and Tidal Sails (further discussed in section 4.5) has been granted permission to build a 3 MW plant in Kvalsundet with a predicted annual generation of 8 GWh.

The United Kingdom's surrounding seas is one of the areas that have large tidal ranges and significant potentials for tidal power. UK is one of the leading countries regarding tidal energy research and development. In addition, studies suggest that previous estimates of the UK available tidal resource may well be an under-estimate [105, 63]. Thus MacKay (2007) claims that previous estimates of the UK tidal resource (of 12 TWh/year) could be an under-estimate by a factor of 10-20¹. In that case tidal power could cover something like 50 % of UK's electricity generation². Therefore there is a significant activity in the tidal sector in the UK, with different companies developing tidal power technology. Plans have also been established for a tidal barrage facility in the Severn Estuary, which alone could cover something like 5 % of Britain's electricity demand [88].

A lot of research and development on tidal power has also been done in North America, with large natural potentials especially in Canada and Alaska. Tidal power activity (constructed plants or plants under construction/planning) are also found in South Korea, China, Russia, Philippines and India [138, 135].

4.2 Why we have Tides

Tides occur as a result of gravitational forces between the earth, moon and sun. These forces keep the earth and moon in orbit around the sun, and the moon in orbit around the earth. The gravitational force between two masses is proportional to the inverse square of the distance between them, and because of this, points on earth facing the moon will feel stronger gravitational forces from the moon than points on the other side of earth situated at a greater distance from the moon. If we simplify the earth to be a solid sphere covered uniformly by a layer of water (figure 4.1), the gravitational forces from the moon will thus deform the water layer so that the water distributes elliptically around the earth (fig. 4.2). The acting gravitational forces accelerate the water nearest to the moon more than they accelerate the center of the earth, and even less the water at the far side of the earth where, due to inertia, a second high tide arises. This elliptical distribution of water shown in fig 4.2 is why we have two high tides and two low tides during a day (one

¹More precisely a factor of D/h where D is the water depth and h is the tide's vertical amplitude.

²Others claim 20 % is a realistic number [141].

earthly rotation).

The gravitational force from the sun acts in the same way as the moon but as the distance to the sun is so large, the effect is about one third in magnitude. However, when the sun, moon and earth are aligned (full moon and new moon), the effects reinforce giving rise to *spring* tides, while when the sun-earth-moon-angle is 90 degrees (half-moons) the effects partly cancel giving rise to *neap* tides. The spring tides have roughly twice the amplitude of neap tides; high tides twice as high and low tides twice as low. However, other effects, like the variations in earth-moon and earth-sun distances (orbits are slightly elliptical) and difference in atmospheric pressure, cause variations in the magnitude of the tides.

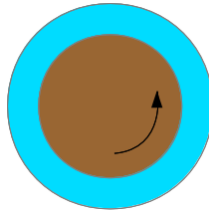

Figure 4.1: The earth modeled as a perfect sphere covered uniformly by water.

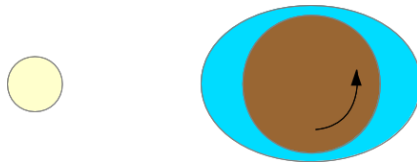

Figure 4.2: The attraction from the moon causes the water to distribute elliptically around the earth, giving rise to two high tides and two low tides per day.

In reality tides are a bit more complicated as the earth is not a perfect sphere and the water is not distributed uniformly around it. Instead of forming an ellipse of water around the earth, the tides traverse as *tidal waves* within the large ocean basins enclosed by continental coastlines. In the North Atlantic Ocean, for example, the tidal wave consist of two crests (high tides) and two troughs (low tides) that circulates around the perimeter of the ocean in an anticlockwise direction once a day. Accumulation of tides occurs in certain areas (red spots in fig. 4.3), and is caused by different shapes and geometry of seabed and shorelines. Another important effect is the Coriolis force:

$$\mathbf{F}_c = -2m\boldsymbol{\Omega} \times \mathbf{v} \quad (4.1)$$

where m is the mass of a particle moving with velocity \mathbf{v} , and $\boldsymbol{\Omega}$ is the earth's rotational vector pointing in direction outwards from the North Pole. The Coriolis Force is caused by inertia together with the fact that the earth rotates. The consequence of the Coriolis Force, as seen by the cross product in the equation, is that objects (like tidal waves) moving with a velocity \mathbf{v} on the northern hemisphere gets slightly bent towards the right, while objects on the southern hemisphere are bent to the left. The Coriolis Force is the reason tides are higher on the French side of the English Channel than on the British side, to take one example, as the tidal waves propagate from the Atlantic Ocean and through the English Channel into the North Sea.

The Coriolis Force and interactions within basins, seas and bays create tidal wave patterns (called amphidromic systems) where tidal waves circulate around points of no tidal range called amphidromic points (white points in fig 4.3). At these points there is no tidal range, however there is often quite strong tidal currents circulating around these points [85].

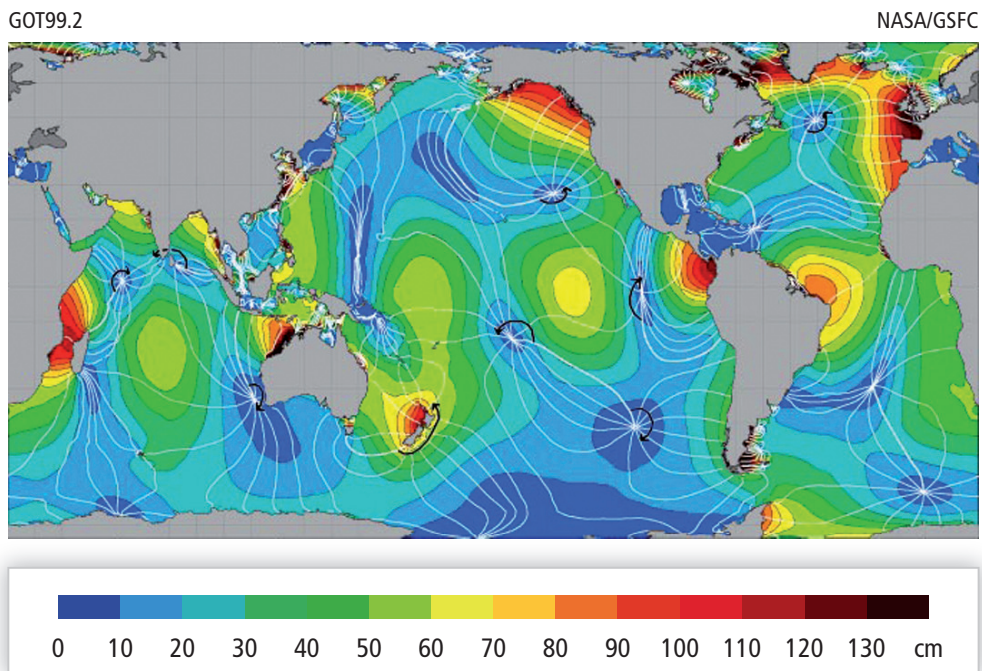

6/99

Figure 4.3: Illustration of the M2 tidal amplitude (tidal amplitudes caused by the moon's attraction). M2 is the largest (semidiurnal) tidal constituent, whose amplitude is about 60% of the total tidal amplitude. White lines are co-tidal lines (lines where all points have the same tidal amplitudes simultaneously). Simulated by NASA. Source: [60]

The magnitude of the tidal range varies greatly at different places. In some estuaries and bays the oscillations of tidal waves can resonate with natural frequencies at the site, resulting in greatly increased tidal range. Consequently, the locations with the largest tidal ranges are at resonant estuaries, such as the Bay of Fundy in Canada (17 m tidal range), the Severn Estuary in the UK (15 m) and Baie du Mont Saint Michel in France (13.5 m). In other places (e.g., the Mediterranean Sea), the tidal range is less than 1 m [85].

4.3 Estimates of Available Tidal Power and Technical Potential

The estimation of tidal resources and the available technical potential is performed in different ways, and as mentioned, with highly different outcome. The most common way of estimating the tidal resource is to calculate the flux of kinetic energy of the fluid flow across a plane;

$$K = \frac{1}{2}\rho AU^3 \quad (4.2)$$

where K is the kinetic energy flux, ρ is the seawater density, A is a cross sectional area, and U is the velocity of the flow. The total technical potential (e.g. for a country or in a certain strait) could hence be calculated by finding the average velocity profile over the total cross sectional area. However, as previously mentioned, such calculation may be under-estimates by factors of 10-20, according to MacKay. He argues that the energy in a tidal wave does not only consist of the kinetic energy flux, but also the potential energy caused by the hydrostatic pressure from the elevated crests. MacKay then calculates the power in a tidal wave both by performing a force balance, and by using basic shallow wave theory, both giving the same result.

As tidal waves are very long compared to depth D , they can be considered as shallow water waves moving with velocity

$$v = \sqrt{gD}, \quad (4.3)$$

where g is the gravitational constant and effects like the Coriolis force are neglected. The horizontal velocity U is (from conservation of mass) given as

$$U = vh/D, \quad (4.4)$$

where h is the amplitude of the wave. The power in such a wave can be calculated by finding the total energy in one wavelength and divide by the

period T . Using that the potential energy per wavelength λ and per unit wavefront is

$$E_p = \frac{1}{4}\rho gh^2\lambda, \quad (4.5)$$

and that kinetic and potential energy in such a wave are equal, we get [142]

$$Power = \frac{1}{2}\rho gh^2\lambda w/T = \frac{1}{2}\rho gh^2v\omega, \quad (4.6)$$

where w is the width of the wavefront. Substituting for $v = \sqrt{gD}$ gives

$$Power = \rho g^{3/2}\sqrt{D}h^2w/2. \quad (4.7)$$

Inserting eqs. 4.3 and 4.4 in eq. 4.2, we get for the kinetic energy flux model

$$K = \frac{1}{2}\rho AU^3 = \rho w(g^{3/2}/\sqrt{D})h^3/2. \quad (4.8)$$

Thus, the kinetic energy flux model scales with amplitude *cubed*, while the shallow wave model scales with amplitude *squared*. The ratio between the two calculations becomes

$$\frac{K}{Power} = \frac{\rho w(g^{3/2}/\sqrt{D})h^3}{\rho g^{3/2}\sqrt{D}h^2w} = \frac{h}{D}. \quad (4.9)$$

Another important aspect considering the energy of a tidal wave is how much of this energy is "lost" to dissipation due to the friction between the flow and the sea bottom. Already in 1920, G. I. Taylor found that 3/4 of the incoming power from a tidal wave flowing into the Irish Sea was lost to tidal dissipation [125]. Taylor calculates, assuming that both the wave and the water current flows sinusoidal, integrating the flow of energy (both kinetic energy and potential energy from hydrostatic pressure) over a surface S , and including effects of Coriolis force as well as direct gravitational work from the moon, that the flux of power passing into the Irish Sea is

$$\frac{1}{2}g\rho U w D h \cos \frac{2\pi}{T}(T_1 - T_0), \quad (4.10)$$

where T_1 is the time of the high water, T is the period of lunar tides, and T_0 is the time of maximum current. U and h are proportional to amplitude, so that the power goes as amplitude squared as in the calculations by MacKay [125, 63].

How much of the energy contained in a tidal wave can be extracted is generally not known. The amount will depend on whether or not, and in what

degree, the potential energy can be exploited, and also on what effect installations of tidal current converters have on tidal dissipation. Most estimates assume that the maximum extractable power is limited by the flow of kinetic energy and the Betz condition³, like in a park of wind turbines. Salter (2009), however, argues that the extractable power in channels should be calculated on basis of the volume flow rate times the pressure head, like in a hydropower plant [106]. He claims that if tidal current converters are installed in long channels in a way that the flow cannot flow alternative routes than through the turbines, the reduced tidal dissipation occurring when power is extracted from the flow (reduced velocity) will add to the pressure exerted on the turbine and thus increase the output. Hence, if multiple installed turbines could reduce the flow velocity by 20%, the dissipation by bottom friction could be reduced by about 50%, much of which will be available to the turbines. Salter concludes that previous calculations of tidal resources in the Pentland Firth, UK, could be an under-estimate of one or two orders of magnitude.

The IPCC Special Report on Renewable Energy contains very little material on global tidal energy resources. It refers to a few studies that estimate that the total global potential of tidal power is in the range of 3 TW of which 1 TW on relatively shallow water, however that only small fractions of this is exploitable [85]. The mean world dissipation of tidal energy is estimated to be about 2.5 TW, most of which will take place in channels with high flow velocities (bottom friction goes as velocity cubed) [106]. This could mean that the corrections to tidal energy estimates (such as proposed by e.g. Salter and MacKay) are of significant size.

4.3.1 Norwegian tidal resource

Norwegian tides arise as tidal waves from the North Atlantic Ocean flushes into the Continental Shelf. Some of the waves enter the *North Sea* from the English Channel and from between Shetland and the west coast of Norway. Here the incoming waves are reflected by the coastlines and thereafter form a complex system of stationary waves with some points of no tidal ranges (nodes), and some points where the range is amplified. As the waves entering the North Sea from the north move away from the Norwegian coast due to the Coriolis effect, the tidal ranges are relatively small along the southern coast of Norway.

Tidal waves also enter the *Norwegian Sea* from between Iceland and the UK. These waves traverse northward along the west coast of Norway, "lean-

³The Betz condition states that the maximum power which can be extracted by inserting a turbine in a free flow is 16/27 of the kinetic energy flux. See ref. [142]

ing” against the shore due to the Coriolis effect. In the North the waves split, some continuing towards Svalbard and some following the shore eastward along Finmark and into the Barents Sea. As the shore, especially north of Finmark, has relatively shallow seas (see figure 4.4), the waves are slowed down leading to an increase of the amplitude of the waves. Thus the largest tidal ranges in Norway (about 4 meters) are found in the north-east.

Another location for interesting tidal effects is in the Lofoten area at 67° latitude in the north-west of Norway. South of the Lofoten Islands is the fjord called Vestfjorden (see fig. 4.5), where topography of the coastline and the shelf cause accumulation of tides also giving tidal ranges of over 4 m. As the shelf north of Lofoten is much more narrow than the broad shelf on the south side (outside Vestfjorden), the tidal ranges are significantly smaller here. This leads to strong tidal currents outside and between the Lofoten Islands [68]. The so-called Lofoten Maelstrom, historically described in [35], can reach current velocities up to 5 m/s.

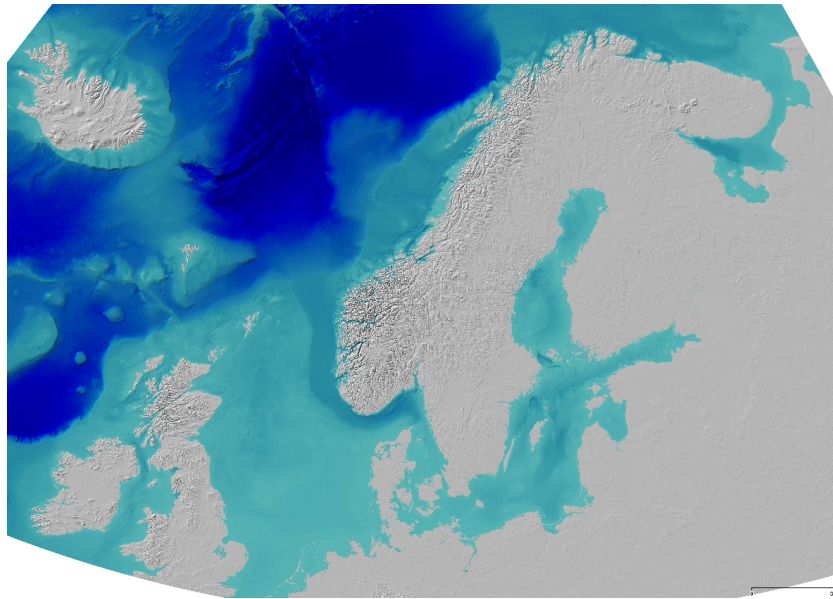

Figure 4.4: Coastal regions surrounding Norway, including oceanic landscape showing the Continental Shelf in the North Sea and outside the coast of Norway. North of Lofoten the shelf is at its narrowest, leading to larger tidal ranges south of-, than north of Lofoten. Shallow waters north of Finnmark cause large tidal ranges here. Source: © Kartverket

A great deal of research has been done regarding measurements and modeling of tidal streams and ranges along the shore of Norway [68, 83, 35, 62].

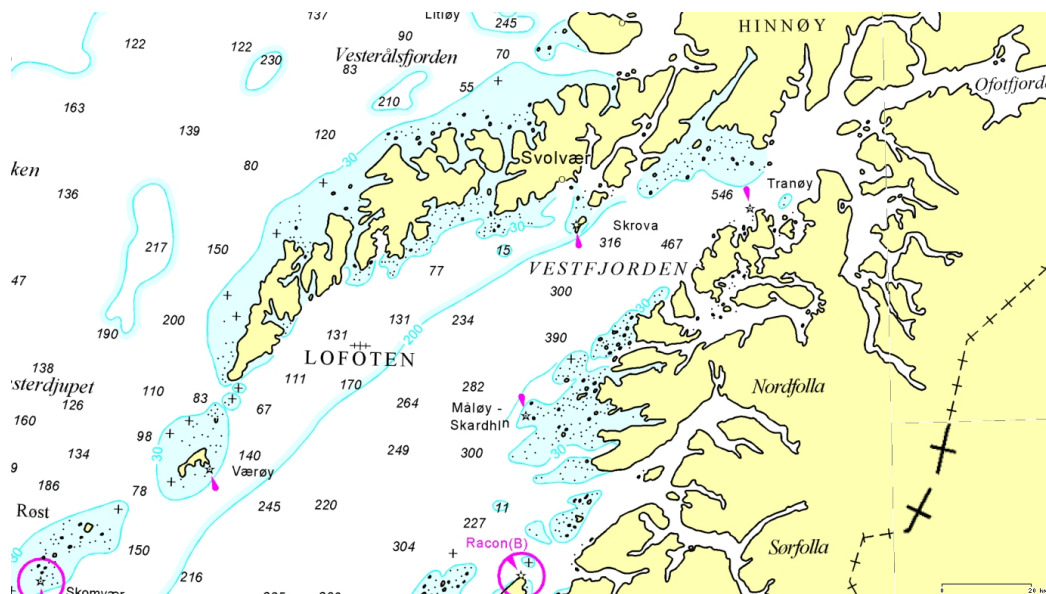

Figure 4.5: Sea map of Vestfjorden, south of the Lofoten Islands. Large tidal ranges in Vestfjorden and small tidal ranges north of the island cause strong currents through and around the islands. Source: © Kartverket

However, most of this research has been driven by the important fish resources, especially around the Lofoten area, and has been aimed to describe the ocean environments like the transportation of e.g. eggs and larvae. Very little has been done on tidal energy resource assessments. In 2009 Grabbe et al. [36] published a paper giving an overview of the estimates that have been made; a master's thesis by E. Fröberg [33], and a report concerning marine renewable resources in Norway prepared by private consultants for Enova SF, a public enterprise owned by the Norwegian Ministry of Petroleum and Energy [107]. Both studies conclude that about 1 TWh per year can be technically exploitable. The calculations are based on tidal stream data provided by *Den Norske Los* [50, 53, 51, 52, 49, 48, 47] from selected locations where the stream exceeds a velocity of a certain value. Fröberg uses data from 12 locations with mean maximum stream velocity above 2 m/s, while the Enova rapport uses 22 locations with mean velocities above 1.5 m/s. The power is calculated using the flow of the kinetic energy model, and by assuming a value of the so-called significant impact factor (SIF), some efficiency, how much of the cross sectional area which can be exploited, and the number of hours of operation per year. They also assume that the velocities vary sinusoidal. Grabbe et al. then extend these studies to a total of 104 different sites, using the same tidal stream data, giving a *theoretical* resource of

17 TWh per year. They do not, however, speculate in how much of this is economically and technically exploitable, as this is expected to be both site specific and technology dependent.

Clearly these desktop estimates are associated with significant uncertainties. They are based on data with little scientific value, initially intended for other purposes than tidal current resource assessments. The uncertainties are also amplified as the power goes as the velocity *cubed*.

4.3.2 Some "back-of-envelope" tidal power calculations

We may try to make some raw, back-of-envelope calculations using the shallow wave model to estimate tidal power entering the Norwegian shore. Let us assume that the energy in the part of the wave front that crosses a line 100 km perpendicular out from the west coast of Norway, is dissipated along the shore. Neglect the south coast and assume a constant depth of $D = 400$ m and an average tidal wave amplitude of $h = 1$ m. The power per unit wave front was found by MacKay to be

$$P_{MacKay} = \frac{1}{2} \rho g^{3/2} \sqrt{D} h^2. \quad (4.11)$$

Using the density of water $\rho = 10^3$ kg/m³ and gravitational constant $g = 10$ m/s² we get

$$P_{MacKay} = \frac{1}{2} 10^3 10^{3/2} \sqrt{400} * 1^2 \simeq 300 \text{ kW/m}. \quad (4.12)$$

This gives us a total raw power of

$$P = 30 \text{ kW/m} * 100 \text{ km} = 30 \text{ GW}, \quad (4.13)$$

which is about the same as the total Norwegian developed hydropower capacity. If say 5% of this could be exploited, and assume conversion and transmission steps are 50% efficient, we could generate

$$30 * 0.05 * 0.05 * 24 * 365 \simeq 6.5 \text{ TWh/yr} \quad (4.14)$$

of tidal energy per year.

Cartwright et al. [19], estimates that the average tidal power fluxes northward through a line between Iceland and the UK is about 120 GW. Although a small part of this power will continue all the way into the Arctic Ocean, nearly all dissipates in the Norwegian Sea and in the Baltic Sea. Keeping in mind the Coriolis effect and the long coast of Norway with shallow waters,

it might be reasonable that a quarter of this, 30 GW, is dissipated along the coast.

Now, let's try to make some estimates of the tidal dissipation, W , around the islands of Lofoten, based on techniques used by Taylor in 1920 [125]. At constant flow velocities, bottom friction causes average dissipation work per unit area of *sea floor* as

$$W/area = K\rho V^3 \frac{4}{3\pi}, \quad (4.15)$$

where V is the maximum value of the flow velocity, v , which is assumed to vary sinusoidal. $\frac{4}{3\pi}$ comes from averaging the \sin^3 term over the lunar period, and K is a constant dependent on the roughness of the seabed. I'll use the same K of 0.002 as Taylor did for the calculation of the Irish Sea tidal dissipation [125], and an average maximum velocity of $V = 2$ m/s based on a quick view of the data presented by Grabbe et al. [36]. This gives

$$W/area = 0.002 * 10^3 * 2^3 * \frac{4}{3\pi} \simeq 7W/m^2 \quad (4.16)$$

To estimate the total friction we need the area of seabed in the sounds. If we say that the total width, w , of all the sounds added is 10 km, and that the average length, l , is 10 km, the total averaged dissipative power is then

$$W = 0.7GW, \quad (4.17)$$

giving about 6 TWh/yr.

Let's compare the dissipated power with the flow of kinetic energy:

$$\frac{W}{E_{kin}} = \frac{K\rho V^3 \frac{4}{3\pi} w * l}{1/2 * \rho V^3 \frac{4}{3\pi} w * d} \quad (4.18)$$

$$= \frac{2Kl}{d}, \quad (4.19)$$

where d is the average depth. Using $K = 0.002$, $l = 10km$ and $d = 40m$, we get a ratio of 1, which indicates that, in the sounds through and around the Lofoten Islands, the dissipated energy is in the same order of magnitude as the flow of kinetic energy.

It's needless to say that these calculations have little scientific value, due to the raw assumptions made. However, they could be an indication that there are large amounts of tidal energy dissipating along the Norwegian shoreline, and that there might be significant amounts of tidal power available.

Conclusions regarding the Norwegian tidal resource should not be based exclusively on kinetic energy flow using data of the velocities in the Norwegian sounds and channels. The effect of deploying tidal stream converters that affect the flow has to be studied in greater detail. A further development of tidal ocean models (already existing [36]), making them suitable for energy calculations, could be a good place to start.

4.4 Tidal Power Technologies

4.4.1 Barrages

To convert the available tidal energy to electrical energy one can either use the potential energy in tidal ranges or the kinetic energy in tidal currents. The most developed technology is to use barrages to enclose water and create a tidal pool from the available tidal range. As the water level changes outside the barrage a head is created and the water can be released through turbines like in a river hydropower plant. By using turbines that can generate in both flow directions, it is possible to generate power at both flood and ebb.

The available power density in such a tidal pool can be calculated by using the equation for potential energy in the gravitational field, $E = mgh$, where m is the mass of the elevated water and h is the change in height of the centre of mass, which is half the tidal range. Thus the mass per unit area covered by the tide pool is $\rho \cdot (2h)$. Assuming the tidal pool can be filled rapidly at high tide, and emptied rapidly at low tide, and that it takes six hours to go from high tide to low tide, the power density is

$$\frac{P_{pool}}{Area} = \frac{2\rho gh}{6hours} \quad (4.20)$$

Thus, given a tidal range of 4 m (i.e. $h = 2\text{m}$), and using for the density of water 1000 kg/m^3 , we get a power density of 3.6 W/m^2 . If we assume an efficiency of 85 % for conversion of this power to electricity, we get a power density of about 3 W/m^2 .

The world's most famous (and world's first) tidal power plant "La Rance" in France uses a barrage to create a tidal pool, generating power using 24 turbines. The plant has been operational since 1966 generating on average a power of 60 MW, with a maximum of 240 MW. It covers an area of 22.5 km^2 and has an average tidal range of 8 m (peak range 13.5 m) with a power density of 2.7 W/m^2 [137]. In 2011 La Rance was surpassed as the largest tidal power plant in terms of power output when Sihwa Lake Tidal Power station (also barrage) in South Korea with a maximum output of 254 MW was finished.

A barrage in the Severn Estuary in UK, as has been proposed and is being discussed, could make a huge 500 km² tide pool. Using a maximum range of 11.3 m and using equation 4.20, the Severn could theoretically generate 14.5 GW. However, using average tidal range, the fact that the pools are not filled and emptied momentarily, some efficiency factor and that the proposal is for generating in one direction only, it is believed that it could generate 2 GW on average, giving about 17 TWh annually [64, 88].

4.4.2 Tidal lagoons

Tidal lagoons are tidal pools made artificially by constructing walls enclosing water. The required conditions for building lagoons are that the water must be shallow and the tidal range must be large.

In Swansea Bay in Wales (in the Severn Estuary, but outside the proposed barrage) an idea has been put forward to construct a tidal lagoon covering an area of 9.4 km² using a 9.5 km-long wall [10]. According to the developers the plant could have a capacity of 250 MW taking advantage of the spring tides of about 12 m.

By constructing two tidal lagoons next to each other it is possible to boost the power output in the following way: One of the lagoons is designated as the "high" lagoon and the other the "low" lagoon. At low tide, some power generated by the emptying high lagoon can be used to pump water out of the low lagoon, making its level even lower than low water. The energy required to pump down the level of the low lagoon is then repaid with interest at high tide, when power is generated by letting water into the low lagoon. Similarly, extra water can be pumped into the high lagoon at high tide, using energy generated by the low lagoon. Whatever state the tide is in, one lagoon or the other would be able to generate power. Such a pair of tidal lagoons could also work as a pumped storage facility.

This "pumping trick" has the capability of increasing the power output significantly. One can calculate a theoretical limit of this technology [64], using an electricity generation efficiency ϵ_g , a pumping efficiency ϵ_p , a tidal range of $2h$, and the optimal extra height b the water level should be pumped to so that the marginal cost of extra pumping equals the marginal return of extra water:

$$b/\epsilon_p = \epsilon_g(b + 2h). \quad (4.21)$$

Defining the round-trip efficiency $\epsilon = \epsilon_p\epsilon_g$, we have

$$b = 2h \frac{\epsilon}{1 - \epsilon}. \quad (4.22)$$

As in equation 4.20, the power density is calculated as the available potential energy divided by the period T between high water and low water. When using the pump trick, however, the water's center of mass is now elevated $(b + 2h)/2$ meters (instead of h meters), so that the energy output per unit pool area is $\rho g \epsilon_g (b + 2h)^2 / 2$. We also need to subtract the work $\rho g \frac{1}{\epsilon_p} b^2 / 2$, needed to pump the water b meters. Finally we get the power density as:

$$\begin{aligned} Power &= \left(\frac{1}{2} \rho g \epsilon_g (b + 2h)^2 - \frac{1}{2} \rho g \frac{1}{\epsilon_p} b^2 \right) / T \\ &= \frac{2 \rho g h^2 \epsilon_g}{T} \left(\frac{1}{1 - \epsilon} \right), \end{aligned} \tag{4.23}$$

showing that the power is boosted by a factor $\frac{1}{1-\epsilon}$, compared to the power without pumping. Using power conversion efficiency of 0.90 and pumping efficiency of 0.85, this factor is about 4. However, if the trick is done at both low tides and high tides, a tidal range of 4 m requires the basin to have a vertical range of 30 m(!), according to eq. 4.22. Hence, the extra construction needs will be severe and it is probably more cost effective (and perhaps aesthetically more reasonable) to expand the horizontal area of the lagoons than to build higher walls. Nevertheless, we see that it seems reasonable to pump some water into/out of a tidal pool to boost the power output, and it may at least be used to reduce the difference in power output between spring- and neap tides.

Pumping into, out of, and between two lagoons also gives the possibility of 24 hours electricity generation, flexibility to meet demand, as well as opportunities for pumped-storage [64].

4.4.3 Tidal currents

The utilization of the kinetic energy in tidal currents is probably where there is most effort put in research and development these days. Since no capacity of any significance has been developed, no standard and widely used technology exists. There are many companies and stakeholders that try to develop, test and optimize their technology in the hope of finding the most effective way of utilizing the tidal currents, and thus make their technique the prevailing in a future development of tidal power. The most common technologies are horizontal axis turbines, vertical axis turbines, oscillating hydrofoils, enclosed ventury systems, Archimedes' screw and tidal kites [21]. In addition other types (e.g. tidal sails) are used as mechanical energy converters. As previously mentioned, there are a number of Norwegian actors, Hammerfest Strøm and Hydra Tidal using horizontal axis turbine technology, Flumill a

type of Archimedes' screw and Tidal Sails and Aqua Energy using sails to generate power.

To estimate the power that can be extracted from a tidal current one first has to estimate the total flow of kinetic energy and then calculate how much could be converted to electricity.

The available power per *unit cross sectional area of flow* in a tidal current with constant velocity U is given as

$$\frac{Power}{Area} = \frac{1}{2}\rho U^3 \quad (4.24)$$

Thus the electrical power P generated by one tidal power converter is

$$P = \frac{1}{2}\epsilon\rho U^3 A \quad (4.25)$$

When considering a horizontal axis turbine the cross sectional area A is given by the diameter d as $\pi d^2/4$. The total efficiency ϵ is the product of turbine efficiency and generator efficiencies. The theoretical maximum of the turbine efficiency is given by the Betz condition as 16/27 [142], or about 59 %, so that real efficiencies have a maximum of 50 %, though probably not higher than 30-40 %.

Tidal stream profiles are bounded with large variations and complexity. Which technology should be used, as well as the areal placement of the converters, will therefore be site specific. A narrow channel will perhaps act like a run-of-river type hydropower plant, where one turbine, or a "fence" of turbines, is sufficient to extract the available power. In a more open waterway, however, where turbines cannot cover the whole cross-sectional area of the flow, tidal stream converters are likely to behave more like a wind farm.

In a wind turbine farm the turbines have to be set up with a distance larger than approximately 5 rotor diameters between them, to minimize the flow disturbance from one turbine on the next (often called "shadowing"). Assuming such a condition applies also regarding tidal currents one can estimate the power per *unit area of land used by one turbine*:

$$\begin{aligned} P/area &= \frac{1}{2}\epsilon\rho U^3(\pi d^2/4)/(5d)^2 \\ &= \frac{\pi}{200}\epsilon\rho U^3[\text{W/m}^2] \end{aligned} \quad (4.26)$$

Since the density ρ of water is approximately 1000 times the density of air, the power per area for same velocities is also 1000 times as big in tidal currents compared to wind farms. We also see that the diameter of the rotor blades,

i.e. size of the turbines, falls out of the equation using these assumptions, and that the most important parameter is the flow velocity U as it enters the equation cubed.

In Kvalsundet in the north of Norway, where Tidal Sails has been granted concession to build a prototype, tidal current velocities are typically 1-2 m/s. Using eq. 4.26 with 40 % efficiency and density 1000 kg/s, the power per land area varies between $6 \text{ W/m}^2 (U = 1 \text{ m/s})$ and up to about $50 \text{ W/m}^2 (U = 2 \text{ m/s})$.

4.4.4 Dynamic tidal power

Another proposal on how to utilize tidal energy is with a technique called *Dynamic Tidal Power*. The idea is to build a 30-50 km long T-shaped pier (see fig. 4.6) perpendicularly out from a sea shore. As tidal waves, and thus also tidal currents, propagate along the sea shore, a tidal range will be created between the two sides of the pier. By inserting turbines in the pier and let water flow through them, it is possible to utilize both the kinetic energy in the flow of water, as well as the potential energy in the range that occur. Wind turbines could also be imagined installed on top of the pier. No existing plant of this kind exists, though some research and calculations have been performed, mainly in South Korea, China and the Netherlands [118].

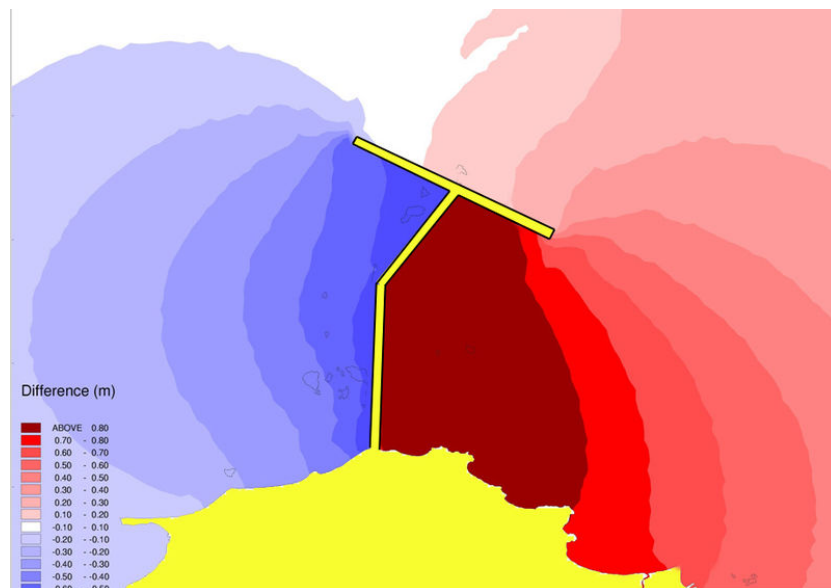

Figure 4.6: Top-down view of a simulated T-shaped Dynamic Tidal Power site. Head of a few meters is obtained in simulations. Source: Wikipedia.

4.5 Tidal Sails



Figure 4.7: Illustration of the Tidal Sails tidal current converter. Reprinted by permission of Tidal Sails.

Tidal Sails is a company located in Haugesund, Norway, developing a technology for tidal stream conversion. It was founded in 2004 by Are Børgesen, a commercial pilot and experienced sailor. During a regatta, sailing against the current, he got some idea of how much power there would be present if the boat was upside down, with the sails being pulled by the current [104].

The Tidal Sails-concept is an equilateral triangle of multiple vertical sails (or wings), connected by two wires like the ones used in alpine skiing lifts. When the force from tidal currents acts on the sails, they are dragged around the triangle as illustrated in figs. 4.7, 4.8 and 4.9. In one of the corners, a generator is installed being set in rotation by the wires to generate power.

Each sail is constantly adjusting its angle of attack to ensure optimal forcing from the current on the sails. On the side of the triangle first facing the incoming tidal current, the sails use the impulse from the current, and the lift forces that arise due to Bernoulli's principle (eq. 2.11) like on the wings of an airplane. After rounding the first corner, the sails are dragged along with the current, like a sailboat with wind from the back. Here the angle of the sails adjusts itself to ensure that the forces outwards from the triangle do not apply disruptive strain to the wires. After having rounded

the second corner, moving against the current, the sails align with the stream so that only a little skin friction slows the sails. When rounding the third corner, the sails again adjust to attain the "starting" position.

Tidal Sails claim to have several benefits compared to other tidal stream converters. They are not dependent on very high current velocity (need only about 1.5 m/s maximum speed to be profitable), the installation is light compared to other tidal turbines, and costs less than 20% of tidal turbines of same capacity. It is also easy to install, with little or no footprint on sea floor, and also demands little maintenance due to corrosion free composite components, water lubricated bearings and no gear box [104]. Environmental impacts are said to be minimal, with no visual impacts, soundless operation, and sails moving with low velocities so that fish are able to avoid the installations.

Tidal Sails has several partners, the Austrian ski-lift ropeway engineering company Doppelmayr is one of them [104]. Over the years Tidal Sails has won several awards for innovation and ideas for energy conversion, and was in 2012 granted funding from the EU to develop MAGNETIDE gearless generators with a minimum of moving parts.

Over the years Tidal Sails has developed small scale test equipment for research and verification of the technology. In 2011 a small scale demonstrator was installed outside Haugesund. "Balder", as it is called, still operates, with a capacity of 25 kW, driven by 40 sails in a triangle with 7 m sides. The next milestone is to install a full scale prototype. Tidal Sails was in February 2013 granted concession by the Norwegian Water Resources- and Energy Directorate to deploy a 3 MW installation in Kvalsundet, Finnmark in the north of Norway [94], for the time period of 2013-2020. In a proposed Enova project with a price of 15 million euros, Tidal Sails is planning to build and deploy their installation during 2013-2015. Half of the 15 million are applied funded by Enova (public enterprise owned by the Norwegian Oil- and Energy Department to support a more environmental friendly energy consumption and generation), while the rest will be financed by Tidal Sails through partners and investors. The site will have about 500 sails that are 5 meters high and 1 meter wide. The sides of the triangle will be 300 m, and the installation is expected to generate 8 GWh per year delivered to the electricity grid, adopting the grid connections previously used by Hammerfest Strøm at the same location.

The future of Tidal Sails will be highly dependent on the outcome of this project. A successful full-scale site is likely to increase the value of the company drastically, while a setback could cause investors and partners to pull out of the project. The same applies for the Norwegian general interest for tidal energy. It's important to have a success story as an eye-opener for tidal power in Norway, and thereby get more support and research funding

for further development. A failure, like what happened a few decades ago to the wave energy plant in Øygarden and recently also partly the Morild 2 project of Hydra Tidal Energy Technology⁴, will be destructive for the future development of tidal energy in Norway.

There are a number of things that in principle could go wrong in a tidal stream installation, making real in situ operational testing a must. Strong tidal currents are associated with complexities like vertical and horizontal shears, vortices, internal waves and harmonics of a channel, as well as floating objects in the flow. Thus, in 2010 in Bay of Fundy, the Irish company OpenHydro installed a 1 MW prototype of their tidal stream converter, which looks like a hydropower turbine without a casing. After just three weeks of operation, two of the blades were broken off due to massive tidal streams 2.5 times the designed velocity of the turbine [69]. Some lessons will have to be learned in Nature's own laboratory.

Whether or not the design of Tidal Sails is robust enough for steady operation in Kvalsundet, remains to be seen. In any case will it be interesting to follow this pioneering project, and other Norwegian tidal power innovators in their quest of being competitive in the energy market.

⁴The floating turbine Morild 2 was installed in Gimsøystraumen, Lofoten, in November 2010. In March 2011, exhaustion of a moving part made one of the propellers fall off. Since then Morild has been out of service. Investors pulled out and the company went bankrupt. However, in 2012 Hydra Tidal AS was established by the power company Straum. They took over the patents and concession in Gimsøyfjorden, and are hoping make Morild 2 ready for operation during 2013

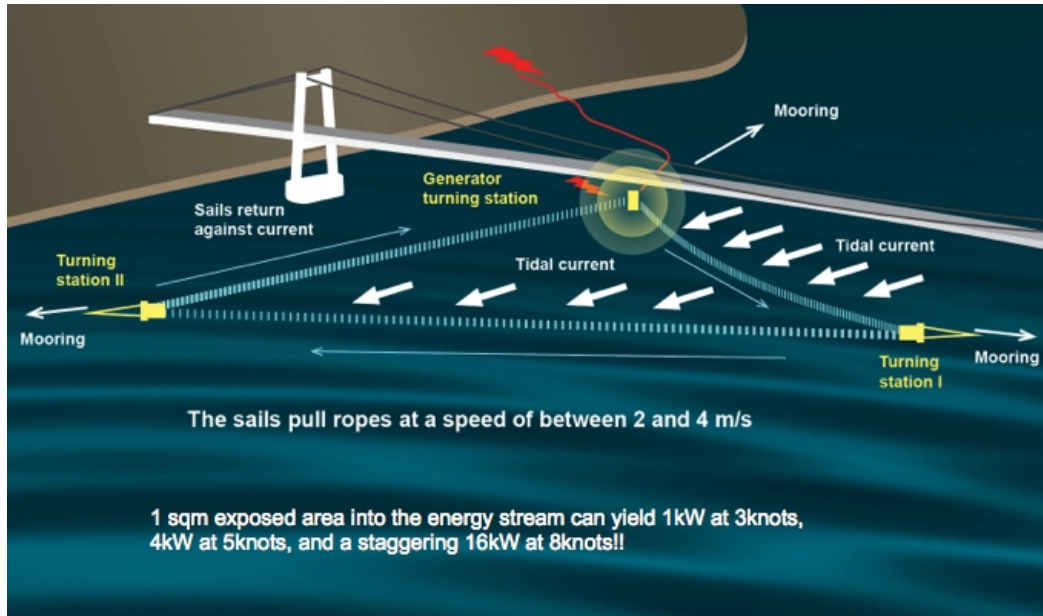

Figure 4.8: Schematic illustration of the planned Tidal Sails installation in Kvalsundet. Reprinted by permission of Tidal Sails.

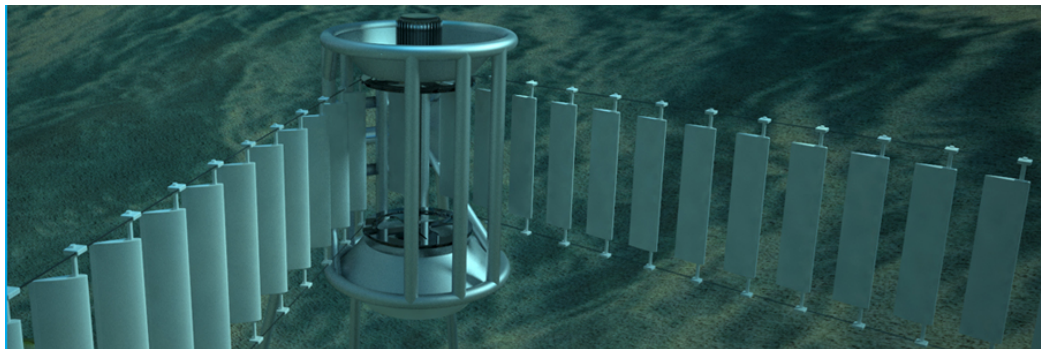

Figure 4.9: Illustration of one of three corners in Tidal Sails' generator. Reprinted by permission of Tidal Sails.

Chapter 5

Future Energy Systems and Role of Hydroelectric Power

5.1 Political Framework

5.1.1 EU politics

EU's policy implies a transition from non-renewable to renewable energy; both to guarantee energy security, and also to counteract possible negative climate development from utilizing fossil fuels.

In chapter 1 simple models were constructed showing the importance of switching from the exponential growth in annual carbon emissions, to reduction at an early stage. The models assumed the occurrence of some sort of global mitigation scheme (GMS) in a year t_1 where the transition initiates. The proposed GMS could be that the global society would agree on some international political framework sufficiently powerful to reduce emissions. So far the United Nations Climate Change Conferences have not lead to such agreements, much due to the fact that an increase of carbon pricing would have great impacts on fossil fuel importers (such as USA before the "shale gas revolution"), and because developing countries like China and India justly require to have the same rights to economic growth as the West have had.

With the absence of a global political framework, the different directives and legislations developed by the European Union are setting the premises of the energy policy in our part of the world. The ambitious EU climate and energy package, containing the well-known 20-20-20 targets¹, as well

¹20% carbon emission reductions compared to 1990 levels, 20% share of renewables, and 20% energy efficiency improvements by 2020.

as the energy roadmap towards 2050, is planned to be met through different legislations providing a detailed framework for each member state. The most important directives are the Renewable Directive, the EU Emission Trading System (EU-ETS), the Effort Sharing Decision (emissions not covered by the ETS system), the Carbon Capture and Storage (CCS)-Directive and the Energy Efficiency Directive [23].

5.1.2 Emissions trading system and carbon price

Emission trading is a pragmatic approach to reduce the global overall emissions of greenhouse gases. Each country are given a certain amount of allowances (or emission quotas) which corresponds to how much they are allowed to emit in order to reach certain targets for emission reduction. If a country chooses to emit more greenhouse gases, they have to buy allowances from other countries which don't use up all of their quotas. In this way each country can either reduce their emissions domestically, or they can pay someone else to do it for them. In either case the result being global reduction of greenhouse gases. The flexibility that trading brings, ensures in principle that emissions are cut where it costs least to do so.

In the Kyoto protocol in 2005, an emission trading system called Clean Development Mechanism (CDM) was introduced. CDM makes it possible for industrialized countries to invest in certain projects in under-developed countries and, for this, receive emission allowances. To be certified as a CDM project, certain criteria must be met. The projects need to contribute with greenhouse gas emission reductions and a sustainable development in the region they are located. They also need to document that they would not be profitable without the investments made. The system has, however, been subject to substantial criticism [31, 129], as the certification process and control is inadequate, leading e.g. to hydropower projects in conflict with agricultural needs, and international companies exploiting poor countries for their resources.

The European Union Emission Trading System (EU-ETS), first implemented in 2005, is the world's biggest emission trading market, accounting for over three-quarters of international carbon trading [24]. Norway, along with Iceland and Lichtenstein, was included in 2008 when the system entered phase two. Today the agreement covers CO₂ emissions from installations such as power stations, combustion plants, oil refineries and iron and steel works, as well as factories making cement, glass, lime, bricks, ceramics, pulp, paper and board. Each country is free to distribute the given allowances as they like. In Norway, land based industry included by the agreement are given allowances corresponding to 87 percent of average emissions in 1998-

2001. Land based process industry is given allowances corresponding to 100 percent since it is more difficult to reduce emissions in this sector. The offshore petroleum installations are not given any, and have to buy quotas for all of their emissions either from state auctions, from the European market or, by buying so called "certified emission reduction" (CER)-allowances from the CDM system [81].

From January 2013, the third phase (2013-2020) of the agreement commenced. In this period a cap on emissions, corresponding to a reduction of carbon emissions of 1.74% per year, was introduced. There have also been suggestions about delaying the sale of 900 million allowances, originally being put out for sale between 2013 and 2015, to 2019-2020. The reason is that due to recession after the recent financial crisis, the price of emitting a ton of CO₂ is about 3 euros, which is too cheap to be a real driver for clean technology development. However, the proposal was recently turned down by 334 to 315 votes in the European Parliament [92].

There are hopes that the EU-ETS in the future will connect to other (national) trading systems, such as the ones already operating in Australia, Japan, New Zealand, Switzerland and the United States, and are planned in Canada, China and South Korea [24]. The Australian system is already planned fully implemented in EU-ETS in 2018. Perhaps this is the beginning of the creation of a global emission reduction scheme. Other carbon pricing methods than the emission trading system, could be a system using carbon taxes, perhaps combined with subsidies for renewable energy technology.

5.1.3 Green certificates

In 2011 Norway along with the other EEA joint, was implemented in the Renewable Directive. The directive describes how each of the member states shall increase their share of renewables for the whole of EU (plus EEA) to reach the target of 20% coverage in 2020. The target set for Norway is to increase the renewable energy consumption to 67.5%, increased from the share of about 60% in 2010. Already in 2011 the share had increased to 65%, nearly satisfying the target, but this was caused by reduction in the total consumption due to a relatively warm year [114].

As an instrument to reach these targets, a unanimous Norwegian parliament agreed to establish the arrangement of Green Certificates². The agreement, which entered into force in January 2012, is a market created together with Sweden to give subsidies for the development of 26.4 TWh (shared between the countries) of new renewable electricity generation by

²The name Green certificates has later been changed to el-certificates

2020. For each MWh of new renewable electricity generated over 15 years, the producer is given an el-certificate, which can be sold in the market [78]. The certificates are financed through an increase of the end-users electricity price.

Although widely supported by politicians and environmentalists, the Green Certificates have been criticized for causing major damage to the environment, for having questionable climate effects, and for being socially unprofitable [17, 41].

The Norwegian Water Resources- and Energy Directorate (NVE) has created an overview of the status of licensing issues regarding new renewable power development received in 2012 [97]. In tables 5.1, 5.2 and 5.3 the data is reproduced, clearly illustrating the effectiveness of the certificates. Within a year, over 1200 applications have been submitted, covering 16 GW installed capacity that could provide about 45 TWh per year.

Hundreds of small, mostly run-of-river type hydropower generators, and dozens of roaming wind parks, will undoubtedly have large environmental impacts associated with them. After the politicians have had the subsidies implemented, it's now left to the caseworkers of NVE to decide how much undisturbed nature and free running rivers should be left untouched. Hopefully will as much as possible of the development be conducted as upgrade and expansion of existing sites.

Regarding the added capacity, the subsidies will probably lead to a power surplus in the market (at least in the first couple of years after the development has taken place) that will cause lowering of the electricity price. The downside of this is that it is unprofitable for the power- and distribution companies (also causing less tax income for the State and municipalities), and that cheap electricity does not encourage energy efficiency measures such as installing heat pumps. Low power prices are, however, positive for the general wealth and purchasing power, and positive for the energy intensive industry such as the metallurgical industry. In the longer view, there could well be a growth in the energy intensive industry in Norway, as the access to cheap, stable and clean power probably will be limited and highly valued in a future energy system. A possible new form of energy intensive industry is large data centers that can handle the fast growing need for data storage. The storage of data from e.g. Google, Facebook, CERN, Apple, etc., requires large amounts of continuous cooling. The cool climate and stable energy supply makes the north of Europe ideal for this kind of industry. Although Norway recently has not been chosen by Google (Finland), Facebook (Sweden) and CERN (Hungary) for their data storage sites, partly due to relatively poor fiber optic cable infrastructure, large underground mines are currently being evaluated for data storage purposes [45, 65]. In 2014 the first construction

step of Greenfield Datacenter in Fet, Akershus is planned completed, storing data for Hewlett-Packard [30]. The center will require 60 MW of constant power supply.

Another potentially positive effect of the certificates is that they contribute to a more stable power situation by adding more variety of energy sources (mainly wind power). In this way the Norwegian hydropower is supplemented with sources of less seasonal fluctuations, which could make Norway less dependent on import of nuclear and thermal power on cold winter days.

Technology	Number of sites	Capacity [MW]	Generation [GWh/yr]
Small hydro (<10 MW)	125	285	904
Upgrade/expansion of existing hydro	14	211	337
Hydro > 10 MW	5	148	439
Wind power	9	678	1943
Sum	153	1323	3623

Table 5.1: Concessions granted

Technology	Number of sites	Capacity [MW]	Generation [GWh/yr]
Small hydro (<10 MW)	55	154	558
Upgrade/expansion of existing hydro	0	0	0
Hydro > 10 MW	0	0	0
Wind power	5	606	1846
Sum	60	760	2404

Table 5.2: Concessions rejected

Technology	Number of sites	Capacity [MW]	Generation [GWh/yr]
Small hydro (<10 MW)	859	2363	7502
Upgrade/expansion of existing hydro	45	418	1706
Hydro > 10 MW	51	2433	4370
Wind power	97	9397	26243
Sum	1042	14611	39821

Table 5.3: Yet to be processed

5.2 Power Transmission

Power transmission and electricity as energy carrier is likely to play a growing role in a future energy system. We are using more and more power consuming devices, transportation may become electrified, offshore activity and other large energy consumers are having a greater need for electricity, and renewable energy converters are often generating electrical power. Fig. 5.1 shows that the European Commission’s de-carbonation scenarios in the EU roadmap towards 2050 all expect that electricity will play a much greater role in a future energy mix, the share almost doubling when approaching 2050.

In a report prepared in 2012 by the Norwegian Oil- and Energy department for the parliament, strategies for a significant upgrade of the Norwegian power transmission system were presented [77]. The background for the upgrading needs is that most of the existing power lines were built between the 1950s and the 1980s. When the deregulation of the power market was implemented in 1991, challenges related to power transmission, such as handling bottlenecks, could be met by price adjustments, and as a result there has been a lack of necessary maintenance since then. Therefore we now have to make upgrades with a cost of 50-70 billion NOK the next ten years according to Statnett [109], to secure a stable power supply. These plans includes voltage upgrading (e.g. from 300 kV to 420 kV) of existing lines, and also construction of new lines. An overview of the different projects, which will be partly funded through an increase in the end-users price for grid connection, is listed in [109].

5.2.1 Power exchange and inter-connectors

In the strategy reports for the development of the Norwegian power net, it is pointed out that there will be an increasing need for power exchange between

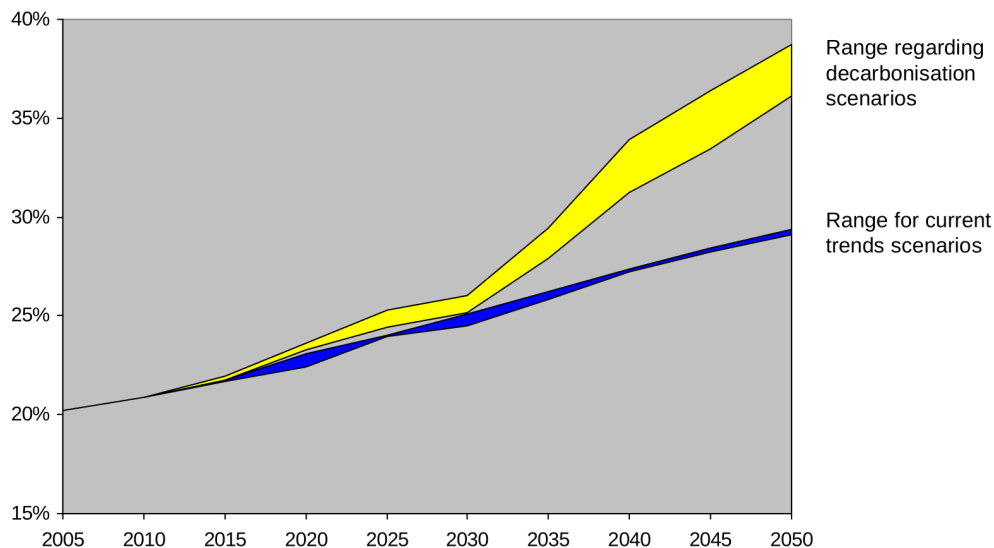

Figure 5.1: The European Commission expects an increase of the share of electricity as energy carrier towards 2050. Source: European Commission, Communication on Energy Roadmap 2050 [25]

Norway and neighbouring countries (including the European countries with North Sea shore), as electricity becomes more important as an energy carrier [110, 77]. At present, the cross boundary transmission capacity is 5400 MW, with Sweden (3600 MW) being the country we have the largest capacity of exchanging power with, followed by Denmark (1000 MW), the Netherlands (700 MW), Finland (120 MW) and Russia (50 MW) [77]. Transmission cables to Sweden, Finland and Russia are above-ground, alternating current (AC) cables, while the inter-connectors to Denmark (Skagerak 1,2,3) and the Netherlands (NorNED) are sub-sea High Voltage Direct Current (HVDC) cables. The NorNED line was finalized in 2008 being the longest underwater power cable (540 km long) in the world, with capacity of 700 MW operating with a voltage of 450 kV.

Statnett has plans for construction of three more underwater inter-connectors within 2020. The Skagerak 4 cable to Denmark is planned to be operational by the end of 2014 with a capacity of 700 MW, a 1400 MW cable between Norway and Germany is planned to be completed in 2018, and a 1400 MW, 700 km long cable between Norway and the UK is planned to be operational in 2020. Other plans for increasing the interconnection between Norway and Sweden (the so-called Sydvest link) have just been put away as they are

considered not to be profitable. If the plans of laying cables to Denmark, Germany and the UK are completed, interconnection capacity could reach a total of 9 GW in 2020, which is about a third of Norway's power generation capacity.

There also exist plans for a privately owned inter-connector (1400 MW) between Norway and Scotland. The so-called NorthConnect project is owned by Scottish and Southern Energy, Vattenfall, Agder Energi, E-CO and Lyse Energi. It is not believed, however, that there is room for two cables to the UK, at least not in the short term, so that Statnett's plans and the NorthConnect will oppose each other. In a proposal to the parliament, the Norwegian government suggests that cross-boundary connections should be monopolized to the national TSO, namely Statnett [54]. However, a change of government in 2013 could reverse this and include private investors [40], something Statnett leader Auke Lont advises against on grounds of security of supply [27].

5.3 Norway as Green Battery for Europe

The vision of using Norway's hydropower reservoirs as a "green battery" for Europe is proclaimed by many in both Norway and overseas [108, 111, 34, 71, 32]. This is truly understandable, taking into account that Norway has about 50% of the total reservoir storage capacity in Europe and that we already, to some extent, possess this role for Denmark's wind power. However, it is vital to have a good understanding of the numbers describing the size of the battery, as well as implications associated with such a system.

5.3.1 Potential size of the battery

Today the capacity of Norwegian hydropower is about 30 GW, of which 75-80% is installed in reservoir type hydropower plants with ability for energy storage. The total amount of energy that can be stored in the reservoirs is 85 TWh, about 70% of Norway's power consumption, and, as mentioned, this corresponds to about 50% of the storage potential in Europe. In a report [119], the Norwegian Water Resources- and Energy Directorate studies 89 reservoir type hydropower plants and estimates that by increasing the number of installations and the discharge of existing sites, the capacity of these plants could potentially be increased by 16.5 GW. Solvang et al. [111] performed a preliminary study of 12 sites, and calculate that their capacity could be increased by 11.5 GW, of which 5.2 GW from 5 pumped-storage type hydropower. Further, they estimate a total technical potential for increased

capacity of storage type hydropower of 20 GW.

This means that the maximum capacity of storage type hydropower probably cannot exceed 50 GW. For comparison, it is estimated that wind and solar will generate 330 GW in Europe already in 2020 [26], with 120 GW in UK and Germany alone. Although the balancing needs probably will be less than all the installed capacity (always some wind somewhere), it's clear that Norwegian hydropower cannot cover all of Europe's balancing needs, a fact Norwegian politicians are starting to realize [77]. With recent plans of increasing the power exchange capacity to 9 GW by 2020, even this associated with large costs and debates around the environmental impacts, the "Norwegian Green Battery" is not the solution to Europe's energy storage challenge, but rather a tool for a more stable power grid system in the Nordic and nearest North Sea countries.

5.3.2 Stable power system

Although Norwegian hydropower cannot balance the whole of Europe, increased power exchange and more cables are on the political agenda and the future strategy of Statnett. With more electrification of our society, the Norwegian power supply will be more vulnerable in dry years. During cold winter days with low water levels in the magazines, the power shortage could exceed the power import capacity, resulting in peaks of very high electricity prices. To avoid these peaks, it is thus important to have sufficient import capacities. In most of the other ends of the cables, i.e. in Denmark, UK, Germany etc. the problem is not how to stabilize the seasonal fluctuations, but rather the short peaks they will experience in times of no wind and sun, together with a high consumption. 10 GW of very flexible power could have a stabilizing effect also for these fluctuations, at least in the critical time before other backup power (such as backup gas power plants) can reach full effect.

An increased power exchange will thus have the effect of reducing the fluctuations in the power net and stabilizing the system. The more cables being constructed, the more similar the various power nets of the countries become. In Norway, where we on average have lower power prices than in the rest of the Nordic countries and on the Continent, the result of more cables will be an overall increase of the average electricity price, but at the same time that we reduce the price shocks we now sometimes experience due to lack of import capacity in times of power shortage [124, 38].

5.3.3 Possible consequences

If Norwegian hydropower to an increasing degree is to be utilized for balancing purposes in the following decades, there are plenty of impact assessments that have to be made beforehand. Increased discharge and pumping between reservoirs will have impacts on both the reservoirs themselves, but also the biodiversity in the reservoirs. It will in many places increase the circulation, which affects the temperature and the environment in general.

The economic impacts of more power exchange also have to be addressed properly. Statnett points out that cables have to be social economically profitable if they are to be built. Some reports suggests that more power exchange is positive for the social economics, mainly because peak balance power from hydropower can be sold at high price, while off-peak electricity from e.g. wind in times of high generation and low demand, can be bought cheap [124]. However, the development of pumped-storage sites may require quite large price differences for them to be profitable [1].

Another important aspect of increased power exchange is the impact it will have on large power consuming industries like the metallurgical industry. As salaries are high in Norway, these cornerstone industries are dependent on low electricity prices to be competitive. An increase of the power price due to more export of cheap hydropower could have the consequence of a large carbon "leakage", in the sense that these industries would be forced to move their activities to e.g. China, where the power to a greater extent is produced from coal plants. Most employer- and employee organization, however, have taken the view that more power exchange should be developed, given that at the same time these industries shall be given CO₂ compensation to cover expenses [61]. Metallurgical industry companies like Hydro consume about 30 TWh of Norwegian hydropower annually, which elsewhere would have had to come from fossil fuels [76]. 20 TWh of this is then exported as (mostly) aluminum products. Compared to power export through cables (about 3 TWh the last couple of years), we see that the metallurgical industry indirectly represents a major export of clean, Norwegian hydropower.

5.3.4 Alternative methods for balancing fluctuations

An important aspect in the debate of Norway as a green battery is that no country wishes to be dependent of others to secure their energy supply and power stability. The deployment of renewables taking place in Europe now is partly driven by climate change, but also to a large degree by the motivation for being energy independent. When implementing a larger share of renewables, the European countries surely prefer not having to rely on

Norway to have a stable power system, and therefore seek other opportunities of stabilizing the grid.

Balancing fluctuations in the power net at all times is not a new challenge that arises with the implementation of intermittent renewables. As shown in section 3.5, the transmission system operators (TSOs) are already today capable of handling large variations, by always ensuring balance between power supply and demand. The implementation of renewables introduces additional challenges, but they are not insurmountable. In addition to using market techniques to control the power output from the different power sources, much effort is now concentrated towards how to control the *demand* side. By developing so-called "smart grids", many power consuming activities could be performed at off-peak hours at a more reasonable price. The heating of buildings, running the washing machine, cooling the fridge, etc., could be automatized with an IT controlled system that initiates such activities when electricity price is below a given value. The implementation of smart grids also provides the possibility of two-way power communication so that generation e.g. from roof top solar PV, could be sold to the grid. A more decentralized storage of energy will also become possible, imagining each house having installed a battery that could be charged and emptied according to grid information from the smart meter. A possibility could be that the charging of the batteries in a fleet of electric cars could take place during night-time and hence provide large balancing services [64, 42]. It is decided that smart meters, so-called Advanced Metering System (AMS), shall be installed in all residents in Norway by 1. January 2019.

Recently, Germany has established a fund for subsidies of battery storage for solar photovoltaic power generation [89]. The arrangement that entered into force 1. May this year is aimed at private households and companies that provide electricity to the grid from solar PV power production (maximum 30 kW). The fund has a total size of 25 million euros, providing subsidies of up to 660 euros per kW of solar power installed.

In Japan, the world's largest battery storage system of 60 MWh, is to be installed in 2015 [90]. The government has allocated 300 million dollars in battery projects, positioning for the balancing of a fast growing solar power industry in the country.

Another promising technology being developed is hybrid windmills. GE (General Electric) recently sold the first of a new line of hybrid wind turbines that comes with a battery attached [18]. IT-technology with algorithms that uses information from forecasts and the electricity grid can calculate estimated power output and then use the batteries to correct for deviations between the actual output and the estimate. In this way, wind energy may be made more or less fully predictable hours ahead, and have the ability of

providing a constant power output (using the batteries) regardless of wind conditions for one hour - enough to initiate backup power. The idea of hybrid wind mills, and storage at generation site, is not new. At Utsira, an island by the south-west coast of Norway, Hydro in 2004 developed a system with wind mills attached to a *hydrogen* energy storage plant [116]. In this way, the small local community could receive stable renewable power supply from otherwise intermittent wind power.

Detailed forecasting of power output on the basis of available wind, amount of clouds, etc., will be an important measure to reduce fluctuations and the need for short term flexible power such as reservoir type hydropower. This will enable the system operators to plan for the up- and down ramping of power supply/demand. When a lull of wind is expected, a gas plant (economically compensated for functioning as a backup plant) could ramp up its power production to prevent power shortage.

In the "Norway as green battery"-debate it's important to account for the development of other methods to solve the fluctuation challenge. If e.g. battery storage, with its flexibility and scalability, makes breakthroughs, is further invested in and continues to grow along with grid intelligence, better markets, and power forecasting, this will influence the applications of the Norwegian hydropower and the inter-connection cables. An example would be the implementation of so-called "capacity markets", currently under planning in the UK and Germany with the intention of compensating backup power plants. Such a market could directly affect the profitability of inter-connectors [73, 130]. It therefore seems prudent to exercise sobriety in the development of cables and pumped-storage hydropower. The complexity of a future energy system should nevertheless, with an increased need for balancing power, be met with research and knowledge on e.g. the environmental impacts say of faster varying water levels in hydropower reservoirs. The changing role of hydroelectric power should also be accounted for when planning new hydropower development, or upgrades of existing plants.

5.4 Can we Mitigate?

When studying the emission model presented in chapter 1, we understand that it can be difficult to figure out where we are, and what kind of emission curve we are currently following, during the years around t_1 (when the fractional change in emissions, $m(t)$, start to decline). This difficulty is amplified as *current* emissions are hard to measure, so that measurements have uncertainties too large to be able to tell us exactly when we have changed from the state of exponential increase with constant rate. Using logical reasoning,

we can nevertheless imagine that factors like the technology development, recession in Europe and the transition from coal to shale gas in the US, could indicate that the rate of annual emissions might have already started to decrease. However, the continuing growth in e.g. China and India, will probably still delay the peak emission year t_2 , for a number of years. If we assume that the annual emission rate $m(t)$ has started to decline since the aftermath of the financial crisis ($t_1 = 2010$), and that it approaches a value of 10% annual reduction as time goes to infinity, we can see from figure 1.11 that the peak emission year can be as late as 15 years after t_1 in order to stay below the 2 degrees target. Such an emission scenario, with peak emissions in 2025, is plotted in figures 5.2 (emission rates) and 5.3 (emissions). We see that in this scenario, we will have large annual emissions in the next 20-30 years or so, before the emissions are dramatically reduced when approaching 2100.

In order to be able to follow such a curve, we see that we are not dependent on some sort of abrupt peak in emissions which could be caused by some sort of global climate agreement. In that sense, single countries or regions should not use the need for an agreement as an excuse to delay their mitigation measures. If for example the EU manages to reduce its emissions by 20% by 2020 compared to 1990 levels, and USA manages to reduce its emissions by 17% compared to 2005 levels, it will help stabilizing the emissions towards 2025, and also hopefully develop new technology and lower the costs of renewables. In the next phase, this could help China and India have a cleaner development, which is key to be able to reduce global emissions.

It seems that the main tool for reducing emissions, and switching from a fossil energy system to a system based on renewables, is to put a price on carbon so that investments in fossil energy carry more risk than investments in renewable energy development. Today, the European emission reductions are mainly caused by the recession, which has caused low carbon prices and an accumulation of allowances for later use. What will happen when Europe recovers financially remains to be seen. It is feared that the shale gas revolution³ in USA will lead to massive export of cheap coal to Europe. Hopefully, the trend we see today is a start of a "green growth" in Europe with many new jobs created within renewable energy sector. Additionally, we can hope that the EU-ETS will develop towards not having the problem of allowance accumulation and cheap prices (by e.g. introducing price floors or by ad-

³Within a couple of years, USA has become more or less energy independent due to the access to unconventional fossils such as shale gas. By using *fracking*, developers now get access to large amounts of underground gas located inside pores and cracks. The use of fracking has been questioned, as it implies large water use, risk of pollution, as well as earthquakes. It has been made illegal in most part of Europe.

justing the number of allowances in the market), and that when the system grows larger, combined with effective measures against carbon leakage, it will eventually be impossible to remain outside such a system due to the lack of trading opportunities.

5.4.1 How Norway can contribute

Being the unique country it is in terms of energy, Norway has the opportunity of playing a vital role in the transition towards an energy system based primarily on renewables. Given that Norway exports about 1000 TWh of gas per year [113], the gas industry represents the activity in Norway which has the strongest direct impacts on the European energy system. Gas is expected to, at least in the next fifty years or so, play an important part as energy source in power systems, hopefully combined with carbon capture and storage (CCS) technology to minimize the emissions. Gas power plants emits less than coal- and oil power plants do, and are also more flexible in terms of up- and down ramping of generation, making them suitable for balancing renewables through so-called mid-merit power generation. To handle fluctuations in power nets is, as we've seen, one of the main challenges related to a future energy system, so that stable gas deliverance to Europe will be one of the most important contributions from Norway to enable the development of renewable energy sources there.

Having long traditions in marine research and activity, Norway could take the position of being a lead actor in the development of marine renewable energy. The long coast with steady wind and relatively shallow waters gives perfect conditions for developing offshore windmill-, and wave energy technology. As discussed in chapter 4, Norway could also have considerable tidal energy resources, in addition to having numerous suitable locations for testing and development of tidal power technology. Through major commitments and investments in research and development regarding marine renewable energy, Norway has great opportunities of contributing with pioneer work that can lead to better knowledge and hopefully important breakthroughs.

A significant initiative requires political will to introduce strong and predictable support schemes for development in the renewable energy sector, perhaps along with some kind of extra price being put on the fossil fuel production. In that way, new jobs and research positions on clean development can be filled with creative engineers and scientists, who otherwise seek towards the oil- and gas sector due to the many jobs and high salaries there. Although such investments possibly will not be profitable in the short term, Norway could probably benefit from positioning themselves against increased carbon pricing and "green growth", that eventually could reduce the demand

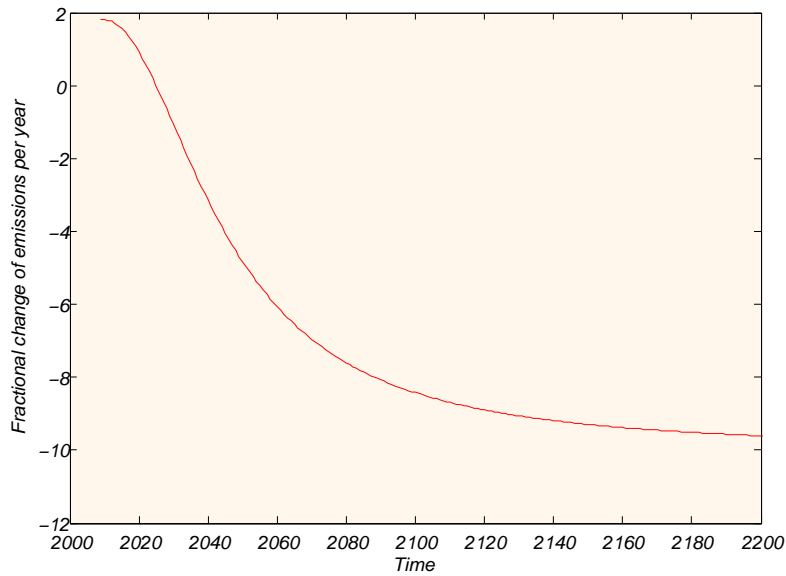

Figure 5.2: The fractional rate of change as function of time, $m(t)$. Starting year of GMS $t_1 = 2010$, peak-emission year in 2025, and approaching a reduction rate of $s = 10\%$.

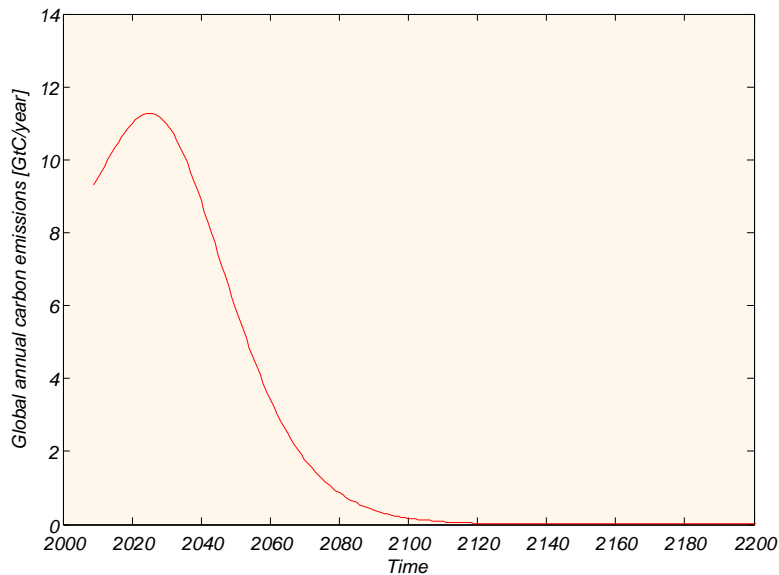

Figure 5.3: Annual global emissions with starting year of GMS $t_1 = 2010$, peak-emission year in 2025 $s = 5$ percent per year, and approaching a reduction rate of $s = 10\%$. Emission scenario results in a maximum temperature increase of 2 degrees.

for fossil fuels. In addition, one can argue that Norway has a special responsibility when it comes to invest in renewable energy, given the amount of fossil fuel production it carries out, and being one of the few countries rich enough to have the ability of taking considerable investment risks to induce development.

An interesting trend in the transition from fossils to renewables, is that investors in the oil- and gas industry are now starting to take into account that large amounts of remaining fossil reserves will have to be embedded in order to reach the 2 degrees target [101]. The expectations that carbon emission prices could rise in the next couple of decades due to changed policies, introduces more risks in their investments and profitability estimates. What this could result in, is that large oil companies themselves start to invest in renewable energy technology. In Norway, Statoil is one of the main investors in clean development through e.g. CCS research, the Hywind floating wind-mill project, and the Sherringham Shoal, Dudgeon and Doggerbank offshore wind park projects. They are also looking into using their drilling expertise in the development of geothermal energy. Another example is Aibel who are constructing their DolWin Beta, a platform for transforming alternating current from offshore wind farms into direct current to be sent to shore via DC cables [5].

Mainly due to the constraints on power transmission, in addition to the size of the balancing needs in Europe, it is unreasonable to believe that Norway can provide major contributions to the European energy mix by an extensive development of pumped-storage hydroelectricity for peak balancing purposes. A more effective way of utilizing the flexible Norwegian hydropower will probably be to use it as balance for an increased amount of intermittent renewables in the Nordic system, to be able to ensure large amounts of cheap, stable power for new energy-intensive industry. Such a solution would be positive for the region's general welfare, and also contribute to reduced global carbon emissions through preventing carbon leakage out of Europe.

By gaining experience from over 100 years of operation, Norway has built up an expertise in hydroelectric power and power transmission. Hopefully we can use our knowledge to contribute to a sustainable development of water management and hydropower in various places around the world. We can also contribute through research and development regarding hydropower upgrades, as well as on technology and impacts related to using reservoir type hydropower more extensively for peak-shaving and handling fluctuations in a future renewable energy system.

Chapter 6

Summary and Outlook

In this thesis we have discussed hydroelectric power and various factors affecting energy systems, in a broad perspective. A model predicting future carbon emissions and temperature change was developed, showing that measures conducted the next few years will be crucial for whether or not we can achieve certain targets for climate change abatement. Future energy systems will have to consist of non-fossil fuels like renewables and nuclear energy, either due to effective, targeted policies, or due to the fact that fossil fuels sooner or later will run out. Countries, energy companies and research institutions should position themselves towards energy systems different from the present.

Electricity is expected to have a more dominant role as energy carrier in future energy systems. Additionally, the introduction of large shares of intermittent renewables like solar- and wind power will make balancing fluctuation in power systems one of the greatest challenges to be met. This will increase the value of stable, predictable and flexible power sources, increase the need for energy storage, and require smart solutions for power transmission.

A historical development of hydroelectric power globally and in Norway was given, as well as an overview of the status of hydropower in present energy systems. We have seen that hydropower development often conflicts with other concerns due to a number of different environmental and socioeconomic issues, which shows the difficulty of reaching the full technical potential. The importance of thorough, holistic planning when developing hydropower projects is argued for, especially regarding development in multi-national basins and in water scarce areas.

Like traditional hydroelectric power, tidal power also represents a fully predictable and sustainable power source. A discussion regarding calculation of tidal energy resource potential was given, highlighting that different methods being used result in significant deviations in value of estimates. An

overview of existing estimates of the Norwegian tidal power resource potential has been presented, in addition to some self-produced back-of-envelope calculations of the tidal power entering the Norwegian shore, and the tidal dissipation around the Lofoten islands. We conclude that existing Norwegian tidal resource estimates are bound with large uncertainties, that the Norwegian tidal resource potential could be greater than what has previously been assumed, and that thorough studies and modeling of tidal resource potential should be conducted.

Discussions regarding the future role of hydroelectric power were made, taking into account political and economic aspects of energy systems. The idea of using Norwegian hydropower as a "green battery for Europe" was given special attention. We argued that it is unrealistic to believe that Norway can provide major contributions to the European energy mix by an extensive development of pumped-storage hydroelectricity for peak balancing purposes, mainly due to the constraints on power transmission, in addition to the size of the balancing needs in Europe. Nevertheless it is expected that reservoir type hydropower will be used more extensively for power net balancing purposes, calling for research and better understanding regarding topics like flexible (reversible) turbines and faster varying reservoir water levels.

Appendices

Appendix A

Source Code

Source codes for generating plots in Chapter 1 are given below. They are written in C++, compiled with g++, and plotted using Matlab.

A.1 Emission Rate Functions and Annual Emission Functions

```
#include <iostream>
#include <math.h>
#include <fstream>

using namespace std;

int main()
{
    ofstream t_out;
    ofstream m_s_out;
    ofstream m_T_out;
    ofstream m_a_out;
    ofstream E_s_out;
    ofstream E_T_out;
    ofstream E_a_out;

    t_out.open("time.txt");
    m_s_out.open("m_s.txt");
    m_T_out.open("m_T.txt");
    m_a_out.open("m_a.txt");
    E_s_out.open("E_s.txt");
    E_T_out.open("E_T.txt");
    E_a_out.open("E_a.txt");
```

```

int t0 , t1 , t4 , anpart , n , k;
float E0 , E , E1 , E2 , t2 , t3 , r , s , b , del_T , del_Ts , t , m;

E0 = 9.3;
t0 = 2009;
t4 = 30000;
r = 0.018;

t1 = 2010;
t2 = t1+15;
s = -0.1;
t3 = (r-s)/r*(t2-t1)+t1;
b = 1.0/((t3-t2)*(t2-t1));

// Emissions Stocker
for ( t = t0 ; t < t4 ; t++ ) {
    t_out << t << endl ;
    if ( t < t1 ) {
        m = r ;
        E = E0 * exp ( r * ( t - t0 ) ) ;
    }
    else {
        m = s ;
        E = E0 * exp ( r * ( t1 - t0 ) ) * exp ( s * ( t - t1 ) ) ;
    }

    m_s_out << m * 100 << endl ;
    E_s_out << E << endl ;
}
t_out . close ( ) ;
m_s_out . close ( ) ;
E_s_out . close ( ) ;

// Emissions Tjalve
for ( t = t0 ; t < t4 ; t++ ) {
    if ( t < t1 ) {
        E1 = E0 * exp ( r * ( t - t0 ) ) ;
        m = r ;
    }

    else {
        m = ( r - s ) / ( 1 + b * pow ( ( t - t1 ) , 2 ) ) + s ;
        E1 = E0 * exp ( r * ( t1 - t0 ) )
            * exp ( ( r - s ) * atan ( ( t - t1 ) * sqrt ( b ) ) / sqrt ( b ) + s * ( t - t1 ) ) ;
    }

    m_T_out << m * 100 << endl ;
    E_T_out << E1 << endl ;
}

```

```

}
m_T_out.close();
E_T_out.close();

// Emissions Allan
for (t = t0;t<t4;t++){
    if (t<t1){
        E1 = E0*exp(r*(t-t0));
        m = r;
    }
    else if (t<t3){
        m = r*(1-(t-t1)/(t2-t1));
        E1 = E0*exp(r*(t1-t0))
            *exp(r*(1-(t-t1)/(2*(t2-t1)))*(t-t1));
    }
    else {
        m = r*(1-(t3-t1)/(t2-t1));
        E1 = E0*exp(r*(t1-t0))*exp(r*(1-(t3-t1)/(2*(t2-t1)))
            *(t3-t1))*exp(r*(1-(t3-t1)/(t2-t1))*(t-t3));
    }

    m_a_out<<m*100<<endl;
    E_a_out<<E1<<endl;
}

m_a_out.close();
E_a_out.close();
}

```

A.2 Required Reduction rates as function of starting year of GMS

```

#include <iostream>
#include <math.h>
#include <fstream>

using namespace std;

int main()
{

```

```

ofstream gms;
ofstream stos;
ofstream t21;
ofstream t22;
ofstream t23;
ofstream t24;
ofstream t25;

gms.open("gms.txt");
stos.open("stos.txt");
t21.open("t21.txt");
t22.open("t22.txt");
t23.open("t23.txt");
t24.open("t24.txt");
t25.open("t25.txt");

int t0,t1,t4,anpart,n,k,len;

float E0,E,E1,E2,t2,t3,r,s,s_stocker,a,b,
I2,I2s,I2allan,C,C0,C1,Ca,beta,
del_T,del_Ts,del_T_allan,y_ends,y_odds,y_evens,
y_ends_allan,y_odds_allan,y_evens_allan,t,h,m,Tmax;

E0 = 9.3;           //GtC per year
t0 = 2009;
beta = 2.0/1000;   //deg per GtC
t4 = 3000;
C0 = 530;          //GtC
r = 0.018;         //% change per year
Tmax = 2;

for (t1=t0;t1<2101;t1++){
s_stocker = r*E0*exp(r*(t1-t0))
            /(E0*exp(r*(t1-t0))-r*Tmax/beta-E0+C0*r);
gms<<t1<<endl;
stos<<-s_stocker*100<<endl;
if (s_stocker<-0.2){
    break;}
len = t1-t0;
}
gms.close();
stos.close();

int v = 0;

for (int y = 1;y<6;y++){
int u = y*y;
for (int j = 0;j<len+2;j++){

```

```

t1 = t0+j;
del_T = 0;
t2 = t1+u;
while (del_T<Tmax){
s = -0.15+0.0005*v;

t3 = (r-s)/r*(t2-t1)+t1;
b = 1.0/((t3-t2)*(t2-t1));

//Stocker I2
I2s = 1.0/-s*(1-exp(s*(t4-t1)));

//Simpsons for integral I2 Tjalve
y_ends = 1.0+exp((r-s)*atan((t4-t1)
    *sqrt(b))/sqrt(b)+s*(t4-t1));
y_odds = 0;
y_evens = 0;
anpart = 4;
h = 1.0/anpart;

    if ((t2-t1)>0){
for (int i = 1; i<(t4-t1)*anpart/2; i++)
    {
        n = 2*i;
        t = t1+n*h;
        y_evens = y_evens + 2*exp((r-s)
            *atan((t-t1)*sqrt(b))/sqrt(b)+s*(t-t1));

        k = 2*i+1;
        t = t1+k*h;
        y_odds = y_odds + 4*exp((r-s)
            *atan((t-t1)*sqrt(b))/sqrt(b)+s*(t-t1));
    }

    I2 = h/3*(y_ends + y_odds + y_evens);}
else
    I2 = 1.0/-s;

//Simpsons for integral I2 Allan
y_ends_allan = 1.0+exp(r*(1-(t3-t1)/(2*(t2-t1)))*(t3-t1));
y_odds_allan = 0;
y_evens_allan = 0;
anpart = 4;
h = 1.0/anpart;

    if ((t2-t1)>0){
for (int i = 1; i<(t3-t1)*anpart/2; i++)
    {
        n = 2*i;

```

```

        t = t1+n*h;
        y_evens_allan = y_evens_allan +
        2*exp(r*(1-(t-t1)/(2*(t2-t1)))*(t-t1));

        k = 2*i+1;
        t = t1+k*h;
        y_odds_allan = y_odds_allan +
        4*exp(r*(1-(t-t1)/(2*(t2-t1)))*(t-t1));
    }

    I2allan = h/3*(y_ends_allan +
        y_odds_allan + y_evens_allan);}
else
    I2allan = 1.0/-s;

//Calculate cumulative emissions and temperature increase
C = C0 + E0*(1.0/r + I2)*exp(r*(t1-t0)) - E0/r;
C1 = C0 + E0*(1.0/r - 1.0/s)*exp(r*(t1-t0)) - E0/r;
Ca = C0 + E0*(1.0/r + I2allan -
    1.0/s*exp(r*(1-(t3-t1)/(2*(t2-t1)))*(t3-t1)))
*exp(r*(t1-t0))-E0/r;

del_T = beta*C;
del_Ts = beta*C1;
del_T_allan = beta*Ca;
v++;
}
v=0;

    if (y==1){
        t21<<-s*100<<endl;
        cout<<-s*100<<endl;
    }

    else if (y==2){
        t22<<-s*100<<endl;
    }

    else if (y==3){
        t23<<-s*100<<endl;
    }

    else if (y==4){
        t24<<-s*100<<endl;
    }

    else if (y==5){
        t25<<-s*100<<endl;
    }

```

```

    }
    cout<<u<<endl;

    }

    t21.close();
    t22.close();
    t23.close();
    t24.close();
    t25.close();
}

```

A.3 Temperature change as function of years before peak emissions

```

#include <iostream>
#include <math.h>
#include <fstream>

using namespace std;

int main()
{
    ofstream peaktime;

    ofstream t11;
    ofstream t12;
    ofstream t13;
    ofstream t14;
    ofstream t15;

    peaktime.open("peaktime.txt");
    t11.open("t11.txt");
    t12.open("t12.txt");
    t13.open("t13.txt");
    t14.open("t14.txt");
    t15.open("t15.txt");

    int t0,t1,t4,anpart,n,k;
    float E0,E,E1,E2,t2,t3,r,s,s_stocker,a,b,
    I2,I2s,I2allan,C,C0,C1,Ca,beta,
    del_T,del_Ts,del_T_allan,y_ends,y_odds,y_evens,
    y_ends_allan,y_odds_allan,y_evens_allan,t,h,m;

    E0 = 9.3; //GtC per year
    t0 = 2009;

```

```

beta = 2.0/1000;    //deg per GtC
t4 = 3000;
C0 = 530;          //GtC
r = 0.018;        //% change per year
s = -0.10;

for (int j=0;j<5;j++){
t1 = t0+1+5*j;

del_T = 0;

for (int u=1;u<52;u++){
t2 = t1+u;

if (j == 0){
peaktime<<u<<endl;
}

t3 = (r-s)/r*(t2-t1)+t1;
b = 1.0/((t3-t2)*(t2-t1));

//Stocker I2
I2s = 1.0/-s*(1-exp(s*(t4-t1)));

//Simpsons for integral I2 Tjalve
y_ends = 1.0+exp((r-s)*atan((t4-t1)*sqrt(b))
/sqrt(b)+s*(t4-t1));
y_odds = 0;
y_evens = 0;
anpart = 4;
h = 1.0/anpart;

if ((t2-t1)>0){
for (int i = 1; i<(t4-t1)*anpart/2; i++)
{
n = 2*i;
t = t1+n*h;
y_evens = y_evens +
2*exp((r-s)*atan((t-t1)*sqrt(b))/sqrt(b)+s*(t-t1));

k = 2*i+1;
t = t1+k*h;
y_odds = y_odds +
4*exp((r-s)*atan((t-t1)*sqrt(b))/sqrt(b)+s*(t-t1));
}

I2 = h/3*(y_ends + y_odds + y_evens);}

```



```

else
  I2 = 1.0/-s;

//Simpsons for integral I2 Allan
y_ends_allan = 1.0+exp(r*(1-(t3-t1)/(2*(t2-t1)))*(t3-t1));
y_odds_allan = 0;
y_evens_allan = 0;
anpart = 4;
h = 1.0/anpart;

  if ((t2-t1)>0){
    for (int i = 1; i<(t3-t1)*anpart/2; i++)
      {
        n = 2*i;
        t = t1+n*h;
        y_evens_allan = y_evens_allan +
          2*exp(r*(1-(t-t1)/(2*(t2-t1)))*(t-t1));

        k = 2*i+1;
        t = t1+k*h;
        y_odds_allan = y_odds_allan +
          4*exp(r*(1-(t-t1)/(2*(t2-t1)))*(t-t1));
      }

    I2allan = h/3*(y_ends_allan +
      y_odds_allan + y_evens_allan);}
else
  I2allan = 1.0/-s;

//Calculate cumulative emissions and temperature increase
C = C0 + E0*(1.0/r + I2)*exp(r*(t1-t0)) - E0/r;
C1 = C0 + E0*(1.0/r - 1.0/s)*exp(r*(t1-t0)) - E0/r;
Ca = C0 + E0*(1.0/r + I2allan -
  1.0/s*exp(r*(1-(t3-t1)/(2*(t2-t1)))*(t3-t1)))
*exp(r*(t1-t0))-E0/r;

del_T = beta*C;
del_Ts = beta*C1;
del_T_allan = beta*Ca;

  if (j==0){
    t11<<del_T<<endl;
  }

  else if (j==1){
    t12<<del_T<<endl;
  }

```

```
    }  
  
    else if (j==2){  
    t13<<del_T<<endl;  
    }  
  
    else if (j==3){  
    t14<<del_T<<endl;  
    }  
  
    else if (j==4){  
    t15<<del_T<<endl;  
    }  
  
    }  
    }  
    peaktime.close();  
    t11.close();  
    t12.close();  
    t13.close();  
    t14.close();  
    t15.close();  
}
```

Bibliography

- [1] Erlend Aamot, Tobias Felber, Peter Strohmer, Per-Erik Söder, and Jörgen Tuomi. Kostnader for ombygging til pumpekraftverk. Technical report, Vattenfall Power Consultant for NVE, 2011.
- [2] U.S. Energy Information Administration. International Energy Statistics. www.eia.gov.
- [3] International Energy Agency. Hydropower and the Environment. Technical report, International Energy Agency, 2000.
- [4] International Energy Agency. Hydropower and the Environment: Present Context and Guidelines for Further Action . Technical report, International Energy Agency (IEA), 2000.
- [5] Aibel. DolWin Beta. www.aibel.com.
- [6] M. R. Allan, David J. Frame, Chris Huntingford, Chris D. Jones, Jason A. Lowe, Malte Meinshausen, and Nicolai Meinshausen. Warming caused by cumulative carbon emissions towards the trillionth tonne. *Nature*, 458:1163–1166, 2009.
- [7] Intelligence Community Assessment. Global Water Security, 2012.
- [8] Electricity Storage Association. Pumped Hydro. www.electricitystorage.org.
- [9] T.H. Bakken, H. Sundt, and A. Ruud. Mange og små eller store og få? En sammenligning av miljøvirkningene ved ulike strategier for utvikling av vannkraft. Technical report, SINTEF Energi AS and CEDREN, 2012.
- [10] Tidal Lagoon Swansea Bay. Harness the power of Swansea Bay. www.tidallagoonswanseabay.com.
- [11] BBC. Pumped storage hydroelectric power station. www.bbc.co.uk.

- [12] B Bjørnson. *Samlede Digter-Verker*. Gyldendal, 1919-1920.
- [13] BKK. Vannkraft i utlandet. Available at www.bkk.no.
- [14] NHA Bowerman, D. Frame, C. Huntingford, J. Lowe, and M. Allen. Cumulative carbon emissions, emissions floors and short-term rates of warming: implications for policy. *Philosophical Transactions Of The Royal Society A-Mathematical Physical And Engineering*, 2011.
- [15] BP. Statistical Review of World Energy 2011. Technical report, BP, 2011.
- [16] BP. BP Energy Outlook 2030, 2012.
- [17] NRK Brennpunkt. Brennpunkt: Et slag i luften? TV documentary, available at www.nrk.no, 2012.
- [18] Kevin Bullis. Wind Turbines, Battery Included, Can Keep Power Supplies Stable. MIT Technology Review, 2013. Available at www.technologyreview.com.
- [19] D.E. Cartwright, Anne C. Edden, R. Spencer, and J. M. Vassie. The Tides of the Northeast Atlantic Ocean . *Philosophical Transactions of the Royal Society of London A*, 298(1436):87–139, 1980.
- [20] Davide Castelvecchi. Gather the Wind. *Scientific American*, 2012.
- [21] European Marine Energy Centre. Marine Energy. www.emec.org.uk.
- [22] European Commission. Strategic Energy Technologies Information System - Hydropower. setis.ec.europa.eu/technologies/Hydropower/info.
- [23] European Commission. Summaries of EU Legislations. www.europa.eu/legislation.
- [24] European Commission. The EU Emissions Trading System (EU ETS). ec.europa.eu/clima/policies/ets.
- [25] European Commission. Energy Roadmap 2050. Communication from the Commission to the European Parliament, the Council, the European Economic and Social Committee and the Committee of the Regions, 2011.
- [26] European Renewable Energy Council. Renewable Energy Technology Roadmap 20% by 2020. Technical report, EREC, 2008.

- [27] dn.no. Advarer NHO og Høyre mot strømkrise. *Dagens Næringsliv*, 2013.
- [28] The Economist. Energy Storage - Packing Some Power, 2011. www.economist.com.
- [29] Aquion Energy. www.aquionenergy.com.
- [30] Entra. Entra lanserer verdens mest sikre og miljøvennlige datasenter. Available at www.entra.no.
- [31] NRK Erling Borgen. Oppgjørets time. Documentary series, 2012.
- [32] Florian Ess, Lea Haefke, Jens Hobohm, Frank Peter, and Marco Wunsch. The significance of international hydropower storage for the energy transition. Technical report, Prognos, 2012.
- [33] Erik Fröberg. Current Power Resource Assessment . Master's thesis, Uppsala Universitetet, 2006.
- [34] Sachverständigenrat für Umweltfragen. Wege zur 100% erneuerbaren Stromversorgung. Technical report, Erich Schmidt Verlag, 2011.
- [35] B. Gjevik. Sources of the Maelstrom. *Nature*, 1997.
- [36] Mårten Grabbe, Emilia Lalander, Staffan Lundin, and Mats Leijon. A review of the tidal current energy resource in Norway. *Renewable and Sustainable Energy Reviews*, 2009.
- [37] R. Edward Grumbine and Maharaj K. Pandit. Threats from India's Himalaya Dams. *Science*, 336:36–37, 2013.
- [38] Einar Hope. Norge som kraftbatteri for Europa? *Magma*, 2011.
- [39] Mara Hvistendahl. China's Three Gorges Dam: An Environmental Catastrophe? *Scientific American*, 2008.
- [40] Siri Meling (Høyre). Interpellasjon i stortinget om mellomlandsforbindelser, 2012. Norwegian Parliament meeting 12. January.
- [41] NRK Ut i Naturen. Ut i naturen: Ikke så grønn likevel? TV documentary, available at www.nrk.no, 2012.
- [42] IEA. *Harnessing Variable Renewables - A Guide to the Balancing Challenge*. International Energy Agency, 2011.

- [43] Pacific Institute. Water Conflict Chronology List. www.worldwater.org/conflict/list.
- [44] Green Power Island. www.greenpowerisland.dk.
- [45] Joakim Birkeli Jacobsen. Naboene banker Norge i utvikling av datasentre, 2013. Agenda Mandag Morgen.
- [46] Chris Arsenault (Al Jazeera). Risk of water wars rises with scarcity, 2012. Available at www.aljazeera.com.
- [47] Kartverket. *Den Norske Los 6: Svalbard og Jan Mayen*. Statens Kartverk Sjøkartverket, 1999.
- [48] Kartverket. *Den Norske Los 5: Rørvik - Lødingen og Andenes*. Statens Kartverk Sjøkartverket, 2001.
- [49] Kartverket. *Den Norske Los 4: Stad - Rørvik*. Statens Kartverk Sjøkartverket, 2003.
- [50] Kartverket. *Den Norske Los 1: Alminnelige opplysninger*. Statens Kartverk Sjøkartverket, 2004.
- [51] Kartverket. *Den Norske Los 2B: Langesund - Jærens rev*. Statens Kartverk Sjøkartverket, 2005.
- [52] Kartverket. *Den Norske Los 3: Jærens rev - Stad*. Statens Kartverk Sjøkartverket, 2006.
- [53] Kartverket. *Den Norske Los 2A: Svenskegrensen - Langesund*. Statens Kartverk Sjøkartverket, 2007.
- [54] Det kongelige olje-og energidepartement. Endringer i energiloven, 2013. Prop. 113 L.
- [55] A. Kumar, T.Schei, A. Ahenkorah, R. Cacaes Rodriguez, J. M. Devernay, M.Freitas, D. Hall, A. Killingtveit, and Z. Liu. *Hydropower*. In *IPCC Special Report on Renewable Energy Sources an Climate Change Mitigation*. [O. Edenhofer, R. Pichs Madruga, Y. Sokona, K. Seyboth, P. Matschoss, S. Kadner, T. Zwickel, P. Eickemeier, G. Hansen, S. Schlomer, C. von Stechow (eds)] Figure 5.9. Cambridge University Press, 2011.

- [56] A. Kumar, T.Schei, A. Ahenkorah, R. Cacaes Rodriguez, J. M. Devernay, M.Freitas, D. Hall, A. Killingtveit, and Z. Liu. *Hydropower. In IPCC Special Report on Renewable Energy Sources an Climate Change Mitigation. [O. Edenhofer, R. Pichs Madruga, Y. Sokona, K. Seyboth, P. Matschoss, S. Kadner, T. Zwickel, P. Eickemeier, G. Hansen, S. Schlomer, C. von Stechow (eds)] Figure 5.1.* Cambridge University Press, 2011.
- [57] A. Kumar, T.Schei, A. Ahenkorah, R. Cacaes Rodriguez, J. M. Devernay, M.Freitas, D. Hall, A. Killingtveit, and Z. Liu. *Hydropower. In IPCC Special Report on Renewable Energy Sources an Climate Change Mitigation. [O. Edenhofer, R. Pichs Madruga, Y. Sokona, K. Seyboth, P. Matschoss, S. Kadner, T. Zwickel, P. Eickemeier, G. Hansen, S. Schlomer, C. von Stechow (eds)] Figure 5.2.* Cambridge University Press, 2011.
- [58] Pijush K. Kundu and Ira M. Cohen. *Fluid Mechanics 4th ed.* Elsvier Inc, 2010.
- [59] Store Norske Leksikon. Blåsjø. www.sn�.no/blåsjø.
- [60] A. Lewis, S. Estefen, J. Huckerby, W. Musial, T. Pontes, and J. Torres-Martinez. *Ocean Energy. In IPCC Special Report on Renewable Energy Sources an Climate Change Mitigation. [O. Edenhofer, R. Pichs Madruga, Y. Sokona, K. Seyboth, P. Matschoss, S. Kadner, T. Zwickel, P. Eickemeier, G. Hansen, S. Schlomer, C. von Stechow (eds)] Figure 6.2.* Cambridge University Press, 2011.
- [61] LO, EnergiNorge, and Norsk Industri. *Industri og kraft: Felles plattform for økt verdiskaping*, 2011. Statement.
- [62] Birgit Kjoss Lynge, Jarle Berntsen, and Bjørn Gjevik. Numerical studies of dispersion due to tidal flow through Moskstraumen, northern Norway. *Ocean Dynamics*, 2010.
- [63] David J.C. MacKay. *Under-estimation of the UK Tidal Recource. University of Cambridge*, 2007.
- [64] David J.C. MacKay. *Sustainable Energy - without the hot air.* UIT Cambridge Ltd., 2009.
- [65] CMO The Norwegian Datacenter Group Mats Andersson. *The norwegian solution. Presentation at Fornybarkonferansen 2013*, 2013. Available at www.fornybarkonferansen.no.

- [66] Warren L. McCabe, Julian C. Smith, and Peter Harriott. *Unit Operation of Chemical Engineering*. McGraw-Hill, 2005.
- [67] M.M. Mekonnen and A.Y. Hoekstra. The Water Footprint of Electricity from Hydropower. *Value of Water Research Report Series No. 51, UNESCO-IHE, Delft, the Netherlands*, 2011.
- [68] H. Moe, A. Ommundsen, and B. Gjevik. A high resolution tidal model for the area around The Lofoten Islands, northern Norway. *Continental Shelf Research*, 2002.
- [69] CBC News. Failed tidal turbine explained at symposium. Available at www.cbc.ca.
- [70] Hermod Nitter. Sustainable Development of Electric Power Systems and Stability Against Fluctuations. Master's thesis, University of Bergen, 2007.
- [71] Dagens Næringsliv. Norge kan bli Europas grønne batteri. Available at www.e24.no.
- [72] United Nations Department of Economic and Social Affairs. Water Scarcity. Available at www.un.org.
- [73] Department of Energy, Department for Communities Climate Change, Local Government, and Ofgem. Electricity Market Reform: Capacity Market - Design and Implementations, 2013.
- [74] US Department of Energy. Energy Storage Database.
- [75] Ministry of Power. Hydro Power Policy 2008. Technical report, Government of India, 2008.
- [76] Norges offentlige utredninger. Energiutredningen - verdiskaping, forsyningssikkerhet og miljø, 2012.
- [77] Det Kongelige Olje og Energidepartement. Meld.St. 14. Vi bygger Norge - om utbygging av strømmettet, 2012.
- [78] Olje og Energidepartementet. Elsertifikatordningen. Available at www.regjeringen.no.
- [79] Olje og Energidepartementet. Lov om vassdrag og grunnvann - Særspørsmål for gernsevassdrag. Available at www.regjeringen.no.

- [80] Olje og Energidepartementet. Fakta 2013 - Energi- og Vannressurser i Norge. Technical report, Olje- og Energidirektoratet, 2013.
- [81] Klima og Forurensingsdirektoratet. Spørsmål og svar om ”CO2 kvoter”. Available at www.klif.no.
- [82] NOU Olje-og Energidepartementet. Energiutredningen - verdiskaping, forsyningssikkerhet og miljø. Available at www.regjeringen.no.
- [83] A. Ommundsen. Models of cross shelf transport introduced by the Lofoten Maelstrom. *Continental Shelf Research*, 2002.
- [84] Intergovernmental Panel on Climate Change (IPCC). *Special Report on Emissions Scenarios*. Cambridge University Press, 2000.
- [85] Intergovernmental Panel on Climate Change (IPCC). *Special Report on Renewable Energy Sources and Climate Change Mitigation*. Cambridge University Press, 2012.
- [86] The World Commission on Dams. Dams and Development - a New Framework for Decision-making. Technical report, The World Commission on Dams, 2000.
- [87] Committee on Foreign Relations United States Senate. Avoiding Water Wars: Water Scarcity and Central Asia’s Growing Importance for Stability in Afghanistan and Pakistan, 2011.
- [88] Hafren power. The Severn Barrage. www.hafrenpower.com.
- [89] PV-Magazine. Germany’s PV storage incentive program will come into force on May 1, 2013. Available at www.pv-magazine.com.
- [90] PVTECH. World’s largest battery storage system to be installed in Japan, 2013. Available at www.pv-tech.org.
- [91] Norwegian Water Resources and Energy Directorate (NVE). Kvartalsrapport for kraftmarknaden, 2013.
- [92] regjeringen.no. Europaparlamentet sa nei til inngrep i kvotesystemet. www.regjeringen.no.
- [93] Norwegian Water Resources and Energy Directorate. Havenergi. www.nve.no/no/Energi1/Fornybar-energi/Havenergi.
- [94] Norwegian Water Resources and Energy Directorate. Konesjonssaker andre energianlegg. Available at www.nve.no.

- [95] Norwegian Water Resources and Energy Directorate. Opprusting og utvidelse. Available at www.nve.no.
- [96] Norwegian Water Resources and Energy Directorate. Vannkraftpotensialet per 1.1.2012. Available at www.nve.no.
- [97] Norwegian Water Resources and Energy Directorate. Ny kraft: Endelige tillatelser og utbygging, 2013.
- [98] Andrew Quinn (Reuters). U.S. intelligence sees global water conflict risks rising, 2012. Available at www.reuters.com.
- [99] MIT Technology Review. 50 Disruptive Companies 2013.
- [100] International Rivers. The World Commission on Dams Framework - a Brief Introduction. www.internationalrivers.org.
- [101] Nick Robins. Unburnable carbon - Implications and strategies for long-term investors, 2013. HSBC report presented at Fornybarkonferansen in Bergen. Available at www.fornybarkonferansen.no.
- [102] Jean-Claude Sabonnadière, editor. *Renewable Energy Technologies*. ISTE Ltd and John Wiley & Sons Inc., 2009.
- [103] Donald R. Sadoway. www.donaldsadoway.com.
- [104] Tidal Sails. www.tidalsails.com.
- [105] S. H. Salter. Possible under-estimation of the UK tidal resource. Submission for DTI Energy Review Question 2.
- [106] S. H. Salter. Correcting the Under-estimate of the Tidal-Stream Resource of the Pentland Firth, 2009. Proceedings of the 8th European Wave and Tidal Energy Conference, Uppsala, Sweden, 2009.
- [107] Jonas Sandgren, Lars Erik Hjorth, Wilfried Pimenta de Miranda, Gry Hamarsland, and Karin Ibenholt. Potensialstudie av havenergi i norge. Technical report, Enova SF, 2007.
- [108] Statkraft SF. Pumpekraft. Available at www.statkraft.no.
- [109] Statnett SF. Statnetts oppdaterte investeringsplan for 2012, 2012.
- [110] Statnett SF. Årsrapport 2012, 2013.

- [111] Eivind Solvang, Atle Harby, and Ånund Killingtveit. Økt balansekraftkapasitet i norske vannkraftverk. Technical report, Center for Environmental Design of Renewable Energy, 2011.
- [112] Statistics Norway (SSB). Elektrisitet, månedstall. Available at www.ssb.no.
- [113] Statistics Norway (SSB). Energiregnskap og energibalanse. Available at www.ssb.no.
- [114] Statistics Norway (SSB). Energiregnskap og energibalanse, 2011-2012, foreløpige tall. Available at www.ssb.no.
- [115] Statnett. Produksjon og forbruk i Norge. Available at www.statnett.no.
- [116] Statoil. Det første hydrogensamfunn, 2007. www.statoil.com.
- [117] Thomas Staubli, Florian Senn, and Manfred Sallaberger. Instability of Pump-Turbines during Start-up in Turbine Mode. Technical report, VA Tech Hydro, 2008.
- [118] Robbert Steijn, Kees Hulsbergen, and Gijs van Banning. DTP: a Tidal Power Revolution. In *Geophysical Research Abstracts, EGU General Assembly 2013*. European Geosciences Union, 2013.
- [119] Kjell Erik Stensby and Norconsult. Økt installasjon i eksisterende vannkraftverk. Technical report, Norwegian Water Resources and Energy Directorate, 2011.
- [120] Thomas F. Stocker. The Closing Door of Climate Targets. *Science*, 339:280–282, 2013.
- [121] Richard Stone. Three Gorges Dam: Into the Unknown. *Science*, 2008.
- [122] Advanced Rail Energy Storage. Grid Scale Energy Storage. www.aresnorthamerica.com.
- [123] Peter Strohmer and Tobias Felber. Pumpekraft i Tyskland. Technical report, Vattenfall Power Consultant for NVE, 2011.
- [124] Håkon Taule, Arndt von Schemde, Eivind Magnus, Anders Skånlund, and Åsmund Jenssen. Fornybarutbygging og mellomlandsforbindelser mot 2020. Technical report, Thema Consulting, 2012.
- [125] G. I. Taylor. Tidal Friction in the Irish Sea. *Philosophical Transactions*, 1920.

- [126] L Thue. *Statens Kraft 1890-1947*. Universitetsforlaget, 2006.
- [127] L Thue. *Statens Kraft 1947-1965*. Universitetsforlaget, 2006.
- [128] L Thue. *Statens Kraft 1965-2006*. Universitetsforlaget, 2006.
- [129] Bergens Tidende. Spillet om klimakronene. www.bt.no/nyheter/klima.
- [130] Teknisk Ukeblad. Kapasitetsmarkedet truer utenlandskabler, 2012. Available at www.tu.no.
- [131] Offentlig utvalg. Energi- og kraftbalansen mot 2020. Technical report, Olje- og energidepartementet, 1998.
- [132] Wikipedia. Cross-flow turbine.
en.wikipedia.org/wiki/Banki_turbine.
- [133] Wikipedia. Francis turbine.
en.wikipedia.org/wiki/Francis_turbine.
- [134] Wikipedia. Hydroelectricity.
en.wikipedia.org/wiki/Hydroelectricity.
- [135] Wikipedia. List of tidal power stations.
en.wikipedia.org/wiki/List_of_tidal_power_stations.
- [136] Wikipedia. Pumped-storage hydroelectricity.
en.wikipedia.org/wiki/Pumped-storage_hydroelectricity.
- [137] Wikipedia. Rance Tidal Power Station.
en.wikipedia.org/wiki/Rance_Tidal_Power_Station.
- [138] Wikipedia. Tidal Power.
en.wikipedia.org/wiki/Tidal_power.
- [139] Wikipedia. Water turbine.
en.wikipedia.org/wiki/Water_turbine.
- [140] Michael Wines. Landslide Risk at Reservoir Cited in China. *New York Times*, 2012.
- [141] Nick Yates, Ian Walkington, Richard Burrows, and Judith Wolf. Appraising the extractable tidal energy resource of the UK's western coastal waters. *Philosophical Transactions of the Royal Society A*, 2013.
- [142] Øivind Holter, Finn Ingebretsen, and Hugo Parr. *Fysikk og Energiresurser*. Universitetsforlaget, 2010.