

Agricultural Production and Food Insecurity in Ethiopia: System Dynamics Approach

by

MELAK MESFIN AYENEW

Submitted in partial fulfillment of the requirements for the degree of Master of Philosophy
in System Dynamics

Supervisor: Professor Pål Davidsen



Department of Geography
System Dynamics Group
University of Bergen
June, 2013

Contents

Abstract	1
Chapter One: Review Literature.....	4
1.1 Attributes of Insufficient Agricultural Production	4
1.1.1 Drought.....	4
1.1.2 Land Degradation and Fertility Decline	5
1.1.3 Agricultural Inputs and Coverage.....	7
1.2 Market Imperfection.....	8
1.3 Rapid Population Growth.....	9
Chapter Two: Food Security Context.....	11
2.1 Definitions and Concepts	11
Chapter three: Research Problem and Hypothesis	14
3.1 Dynamic Problem.....	14
3.2. Hypothesis	16
3.2.1 Causal Loop Structure	19
3.2.2 Stock and Flow Structure	35
3.2.2.1. Population.....	35
3.2.2.2 Agricultural Production.....	36
3.2.2.2.1. Land Use Dynamics	36
3.2.2.2.2.Land Fertility Dynamics.....	45
3.2.2.3 Market	46
3.2.2.3.1 Food Consumption Need.....	46
3.3.2.3.1.1 Desired Cereal Consumption.....	47
3.3.2.3.1.2 Per-Capita versus Adult-Equivalent Estimates of Calorie Consumption	48
3.3.2.3.1.3 Calorie Consumption Trends and Desired Calorie Share of Cereals	51
3.3.2.3.2 Desired Effective Cereal Consumption	55
3.3.2.3.2.1 Review of Household, or Per-capita Income, Consumption, and Expenditure Surveys	55
3.3.2.3.2.1 HIEC (1995, 1999/00) Survey Food Expenditure	57
3.3.2.3.2.2 HICE (2004/5), and HCE (2010/11) Surveys.....	58
3.3.2.4 Cereal Inventory, Supplies and Shipments.....	61
3.3.2.4.1 Delivery of Cereals.....	62
3.3.2.4.1.1 Private Holders' Meher Production Cereal Delivery.....	62
3.3.2.4.1.2 Private Holders' Belg Production Cereal Delivery	63

3.3.2.4.1.3 Annual Net Cereal Imports and Delivery	65
3.3.2.4.1.4 Commercial Holders' Cereal Delivery	67
3.3.2.4.2 Cereal Shipments.....	67
3.3.2.4.2.1 Consumption Shipments.....	68
3.3.2.4.2.2 Industrial Shipments	69
3.3.2.4.3 Post-Harvest Losses.....	70
3.3.2.5 Cereal Price	71
3.3.2.6 Revenues, Agricultural Inputs and Yield	77
3.3.2.6 Undernourishment	84
Chapter Four: Model Validation and Behavioral Analysis	86
4.1 Direct Structure Test	86
4.2 Unit consistency Test	87
4.3 Reference and Model Simulated Behavior Test	88
4.4 Structure-Behavior Tests	91
4.5 Extreme Condition Test.....	98
4.6 Sensitivity Analysis.....	103
4.7 Behavior Analysis	107
4.7.1 Behavior Analysis of Cereal Consumption and Access	107
4.7.2 Behavioral Analysis of Cereal Production and Market	115
Chapter Five: Policy Analysis	124
5.1 Land Conservation and/ or Land Rehabilitation.....	125
5.1.1 Model Structure of the Soil Conservation / Rehabilitation Policy	126
5.1.2 Causal Loop Structure	126
5.1.3 Stock and Flow Structure	126
5.2 Agricultural Input Supply Capacity Building.....	130
5.2.1 Causal Loop Structure	131
5.3 Land Management (Adjustment).....	133
5.3.1 Causal Loop Structure of Land Management Policy.....	134
5.4 Policy Testing.....	135
5.4.1 The Base Run	135
5.4.2 The Soil Conservation / Rehabilitation Policy Activated.....	137
5.4.3 Agricultural Input Capacity Building Policy Activated	138
5.4.4 The Sustainable Land management Policy Activated	140
5.4.5 All policies Activated.....	141

5.5 Scenarios	143
5.5.2 Rainfall Scenario	143
5.5.1 Expenditure Scenario.....	144
Chapter Six: Conclusion and Recommendation.....	146
6.1 Major Findings	147
6.2 Limitation of the Study and Future Research Areas.....	149
References	151
Appendix: Sensitivity Analysis	156
Appendix B: Model Equations	157

Figures

Figure 1: <i>Cereal production of the main (Meher) season.</i>	10
Figure 2: <i>Levels of food security/insecurity</i>	11
Figure 3: <i>Food assistance needy population.</i>	14
Figure 4: <i>Prevalence of undernourishment</i>	15
Figure 5: <i>The main causal loop diagram representing the feedbacks of the explanatory model.</i>	19
Figure 6: <i>Balancing loop B1</i>	20
Figure 7: <i>Reinforcing loop R1</i>	21
Figure 8: <i>Reinforcing loop R2</i>	22
Figure 9: <i>Reinforcing loop R3</i>	23
Figure 10: <i>Balancing loop B3</i>	24
Figure 11: <i>Balancing loop B2</i>	25
Figure 12: <i>Balancing loop B4, and reinforcing loop R4</i>	26
Figure 13: <i>Conserving loop C1</i>	27
Figure 14: <i>Conserving loop C2</i>	28
Figure 15: <i>Balancing loop B5</i>	29
Figure 16: <i>Balancing loop B6</i>	30
Figure 17: <i>Balancing loop B7</i>	31
Figure 18: <i>Reinforcing loop R5</i>	32
Figure 19: <i>Balancing loop B8</i>	33
Figure 20: <i>Balancing loop B9</i>	34
Figure 21: <i>Stock and flow diagrams of population dynamics</i>	36
Figure 22: <i>Stock and flow diagram of the main land use model</i>	37
Figure 23: <i>Main season (Meher) cereal cultivation area</i>	40
Figure 24: <i>Land degradation severity classes</i>	41
Figure 25: <i>the stock and flow structure of the degradation dynamics within the stock of cultivated land</i>	44
Figure 26: <i>Model structure showing the relationship of the population age cohorts and cumulative adult-equivalent fraction.</i>	50
Figure 27: <i>Model structure representing the computation of annual desire cereal consumption</i>	55

<i>Figure 28: The per-capita income (red curve) and expenditure (blue curve) distribution on income and expenditure group, 1995 and 1999/00 respectively.</i>	<i>56</i>
<i>Figure 29: Comparison of per-capita food share (red curve) and cereal share (blue/grey curve) of 1995 and 1999/00.</i>	<i>57</i>
<i>Figure 30: Per-capita total calorie share of cereals in 2004/5 and 2010/11</i>	<i>58</i>
<i>Figure 31: Comparison of average annual per-capita cereal budget obtained from the use of average per-capita expenditure and the use of average per-capita expenditure distribution over quintiles.</i>	<i>59</i>
<i>Figure 32: The stock and flow structure of cereal inventory and its supplies and shipments.</i>	<i>61</i>
<i>Figure 33: seasonal distribution of Meher cereal delivery.....</i>	<i>63</i>
<i>Figure 34: Seasonal distribution of Belg cereal delivery.</i>	<i>65</i>
<i>Figure 35: Model structure of cereal inventory, cereal supplies and shipments.....</i>	<i>71</i>
<i>Figure 36: shows the producer price of some cereals.</i>	<i>73</i>
<i>Figure 37: The effect of inventory ratio on desired producer price.</i>	<i>74</i>
<i>Figure 38: The retailer fuel price of Gasoline and Diesel in USD.....</i>	<i>75</i>
<i>Figure 39: The currency exchange rate of USD in to Birr.</i>	<i>75</i>
<i>Figure 40: The development of total road network in the country.</i>	<i>76</i>
<i>Figure 41: The model structure of both producer and consumer price adjustments.....</i>	<i>77</i>
<i>Figure 42: Market and investment, and yield model structure</i>	<i>78</i>
<i>Figure 43: Total fertilizer consumption author computation.</i>	<i>79</i>
<i>Figure 44: The development of fertilizer price over the time under consideration</i>	<i>80</i>
<i>Figure 45: Improved seed price (birr per-quintal).</i>	<i>81</i>
<i>Figure 46: Model structure of yield</i>	<i>83</i>
<i>Figure 47: Prevalence of undernourishment</i>	<i>85</i>
<i>Figure 48 (a-l): The comparison of historical and model generated graphs.</i>	<i>90</i>
<i>Figure 49: Causal loop diagrams of the main loops of the model.....</i>	<i>92</i>
<i>Figure 50: The comparison of the simulation results with the base run when R2 is being cut, before (1-blue) and after (2-red).....</i>	<i>93</i>
<i>Figure 51: Comparison of the simulation results of prevalence of undernourishment before (1-blue) and after (2-red) the loop R3 is being cut.</i>	<i>95</i>
<i>Figure 52: Comparison of simulation results of cereal cultivation area and prevalence of undernourishment when the loop R is being cut.</i>	<i>96</i>
<i>Figure 53: Comparison of simulation results of relative inherent yield, maize current yield and prevalence of undernourishment when loop B5 is being cut.</i>	<i>97</i>

<i>Figure 54: Simulation results of desired effective cereal consumption and prevalence of undernourishment with the extreme minimum test (cereal expenditure share = 0).</i>	98
<i>Figure 55: Simulation results of desired effective cereal consumption and prevalence of undernourishment with the extreme maximum test (cereal expenditure share = 1).</i>	99
<i>Figure 56: Simulation results of cereal yield and production for the extreme tests average rainfall.</i>	100
<i>Figure 57: Simulation results with the extreme condition test of topsoil loss rate (blue-base rune, red-0 loss rate and pink- 1cm /year loss rate).</i>	101
<i>Figure 58: Simulation results with the extreme conditions of Kcal share for cereals.</i>	103
<i>Figure 59: The sensitivity analysis of non-productive land, potential arable land, cereal cultivation land, and prevalence of undernourishment with the land rehabilitation time.</i>	104
<i>Figure 60: Sensitivity analysis with the elasticity of markup fraction.</i>	105
<i>Figure 61: The sensitivity analysis with the change in fallowing fraction.</i>	106
<i>Figure 62: Causes of population growth</i>	108
<i>Figure 63: The change in demography and adult-equivalent calorie consumption.</i>	108
<i>Figure 64: The effect of change in adult-equivalent calorie consumption, and the calorie share of cereals on the daily calorie consumption</i>	109
<i>Figure 65: desired cereal consumption (Annual)</i>	110
<i>Figure 66: The simulation behavior of total annual budget of cereal and its inputs.</i>	111
<i>Figure 67: Retailer price of cereals</i>	112
<i>Figure 68: Desired purchased cereal.</i>	112
<i>Figure 69: Economic constrained of desired effective cereal consumption</i>	113
<i>Figure 70: Comparison of desired effective cereal consumption (blue) and the consumption shipment (red)</i>	113
<i>Figure 71: The behavior of the number of population desired to be nourished (blue) and the number of population effectively nourished (red).</i>	114
<i>Figure 72: Life expectancy and prevalence of undernourishment.</i>	115
<i>Figure 73: Desired cultivation land, cultivation land and potential cultivation land.</i>	116
<i>Figure 74: The behavioral interaction of cultivation area, and yield resulting production.</i>	117
<i>Figure 75: Behavioral interaction of meher production delivery, inventory, and shipment for consumption</i>	118
<i>Figure 76: The behavioral interaction of inflation rate, and inventory ratio determining price</i>	119

<i>Figure 77: Revenues of production and investment for production.....</i>	120
<i>Figure 78: Coverage of fertilizer and improved seed</i>	121
<i>Figure 79: Inherent / potential yield and current yield</i>	122
<i>Figure 80: Relative yield and per-capita expenditure</i>	123
<i>Figure 81: Main causal loop structure of the explanatory model (in black or brown color) and the new policy model (in blue color).....</i>	124
<i>Figure 82: The stock and flow structure of the soil conservation policy (in blue)</i>	127
<i>Figure 83: Expected capacity building fraction</i>	129
<i>Figure 84: The effect of soil conservation coverage on the average top soil depth loss and falling fraction.....</i>	130
<i>Figure 85: The stock flow structure of the capacity building policy.</i>	132
<i>Figure 86: The fraction of import of cereals.....</i>	135
<i>Figure 87: The bases run of some of the variable.....</i>	136
<i>Figure 88: The comparison of the base run and the soil conservation policy for some selected variables.....</i>	138
<i>Figure 89: The simulation result of capacity building policy.</i>	139
<i>Figure 90: The simulation behavior of the model when policy three is applied.....</i>	141
<i>Figure 91: The simulation results when the three policies are activated.</i>	142
<i>Figure 92: Rainfall scenarios</i>	144
<i>Figure 93: The development of prevalence with the per-capita expenditure scenarios base run (blue), slow growth (red), moderate growth (pink), and fast growth (green).</i>	145

Tables

Table 1: Number of settlers in the four main regions of Ethiopia.....	38
Table 2: Adult-equivalent calorie conversion factor.....	49
Table 3: Daily calorie share of cereals from the daily calorie consumption of food	51
Table 4: Cereals and their Kcal per 100 gram of edible portion	53
Table 5: Industrial extraction rate of some cereal	54
Table 6: Time series table of average per-capita expenditure and weighted average cereal expenditure share	60
Table 7: Annual Belg production of some cereals of the reported years	64
Table 8: Net import of main cereals.....	66
Table 9: Comparison of domestic production of cereals.....	67
Table 10: Industrial cereal shipments for large and medium scale manufacturing industries .	69
Table 11: Comparison of total industrial cereal shipments excluding barley malt for large and medium scale manufacturing industries and total cereal commercial production	70
Table 12: Annual improved seed sales of ESE	80
Table 13: Cereals input coverage.....	81
Table 14: Yield of cereals with improved technology and traditional trials	82
Table 15: Average yield of cereals	83
Table 16: Unit of some variables	87
Table 17: The Theil's inequality statistics	91

Acronyms

ARS-	Amhara Regional State
BGRS -	Benshangul-gumuz Regional State
CLD-	Causal Loop Diagram
CSA -	Central Statistical Agency
CRGE-	Climate Resilience Green Economy
DHS-	Demographic and Health Survey
DRMFSS-	Disaster and Risk Management Food Security Sector
ECRGE-	Ethiopia Climate Resilience Green Economy
EGTE-	Ethiopian Grain Trade Enterprise
EHNI-	Ethiopia Health and Nutrition Research Institution
ESE-	Ethiopian Seed Enterprise
FAO -	Food and Agricultural Organization of the United Nation
FAOSTAT-	Food and Agricultural Organization of the United Nation Statistical Division
GDP-	Gross Domestic Product
GTP -	Growth and Transformation Plan
HCE-	Household Consumption and Expenditure
HICE-	Household Income Consumption and Expenditure
Kcal-	Kilo Calorie
MARD -	Ministry of Agriculture and Rural Development
MH -	Ministry of Health
MoA-	Ministry of Agriculture
NASIP-	National Agriculture Extension Program
NFP-	Non-Fertile Land
SD-	System Dynamics
SNNP	Southern Nations Nationalities People
WHO-	World Health Organization
WBISPP-	Woody Biomass Inventory and Strategic Planning Project

Acknowledgment

I am very thankful to my professors David Wheat, Erling Moxnes, Pål Davidsen, Birgit Kopainsky, and Matteo Pedercini for their inspiring lectures in system dynamics. Regarding the process of developing this master thesis, I would like to express my gratitude to Professor Pål Davidsen for his invaluable help and unconditional support. I would like to thank my family, especially, my wife, Seraye Aseressie, for their courage and support through the difficult conditions. And last but not least I would like to thank the people working in central statistical agency, Ministry of Agriculture, FAO, and Agricultural Research Institute, for their help in the data collection process.

Abstract

Agriculture has been the main economic activity of many Ethiopians for centuries, and it has employed around 80 % of the population. Despite the involvement of a large proportion of population in the food production, food insecurity has been the main problem in which a large proportion of the population is undernourished or acquires food consumption below the minimum requirement. Identifying the causes of the problem has been vague as it involves complex characteristics such as; time delay, non-linearity, feedback etc. which affects our understanding of the main structure. Previous research has pointed out the causes of the food insecurity as; insufficient agricultural production, imperfect market, rapid population growth etc. However, the analysis of most of the research undertaken has not been integrated to include all of the factors in the study and able to provide comprehensive analysis of the problem. Moreover, the analysis has not address access of food at household and per-capita level. In this thesis, system dynamic model is used to identify the underlying problematic structure by modeling the population, land use & land fertility, and market sectors. The simulation results have replicated well the historical data and show that both availability and accessibility of food have been the main constrained to food consumption. Moreover, the change in land productivity associated with land degradation, and the degradation effect to food insecurity has been insignificant in the analysis covered by this. We have examined the effect of future policy options, such as improving land management and the application of improved technologies, in improving the food security.

Key words: Food insecurity, system dynamics, land fertility, land degradation, life expectancy, prevalence of undernourishment, producer price, food availability, food accessibility, expenditure, yield.

Introduction

Food security has been a problem for people in the world. In particular developing countries, such as Ethiopia, have been facing severe version of this problem over a longer period of time. The complex interaction in the process of decision making in the context of adverse environmental conditions has made it difficult to tackle the problem in the short run (Giraldo, D. et al., 2011, Tesfahun, F. et al., 2003). As an indication of the complexity of the situation, after opting for a reduction in the number of undernourished people by 50 %, to no more than 420 million people in 2015, at the world food summit¹ in 1996, the plan was put under question, in view of the fact that there has been an increase in the number of undernourished people amounting to 1.02 billion worldwide in 2009 (FAO, 2009).

In Ethiopia, food security has been a huge challenge for decades. Since the 1970s, there has been a series of production failures that has resulted in chronic food insecurity (Kaluski, D.N. et al., 2001). In the last decades, there have been several million people who required immediate food assistance. As a result, Ethiopia has been the largest recipient of food aid in Sub-Saharan Africa. A wider indicator of the extent of food insecurity at a national level is the prevalence of undernourishment. This prevalence demonstrates that a large proportion of the population has been undernourished over the last one and a half decades. The proportion of population undernourished was 64 percent (approximately 34 million people) in 1995. Thereafter, there has been a progressive improvement (approximately a linear decline) to 40 percent (32 million people) in 2010 (FAO-food security indicator, 2013). However, the prevalence of undernourishment till remains at such a high level that effort for future improvement are required.

Agriculture has been the main economic activity of many Ethiopians for centuries and the main characteristic of Ethiopian agriculture is its dependence on rainfall. The limited production and productivity has mainly been attributed to; insufficient rainfall, land degradation, low input application, and market imperfection (Chadhokar, A.P., 2003, Demeke, M., 2003, Gabriel A., 2003, Zelleke, G. et al., 2010, Jolejole-Forman, M. C., 2012).

¹ The World Food Summit was held at FAO Headquarters in Rome, Italy, from 13 to 17 November 1996, FAO-Undernourishment refers to the condition of people whose dietary energy consumption is continuously below a minimum dietary energy requirement for maintaining a healthy life and carrying out a light physical activity with an acceptable minimum body-weight for attained-height.

Cereal production constitutes the largest share of the total food production. Efforts have been made to increase food production in the last decade in Ethiopia. The cereal production of the main harvesting season or (Meher season, estimated around 95 % of the total production) has been increased from 63.49 million quintals in 2002, to reach its maximum 177.61 million quintals, in 2010 (CSA, 1995-2010). The increase in cereal production has contributed to reduce the food insecurity, specifically through improving the availability of food on the market. The increase in the production however, does not decrease correspondingly the amount of undernourished people in the population since the population has been growing at the same time i.e. the increase in production has been absorbed by the growing population.

Previous research has pointed out the causes of the food insecurity as: an insufficient agricultural production associated with erratic rainfall, land degradation, an imperfect market, rapid population growth etc. However, little has been studied in integrating the various causes of food insecurity. An integrated approach, system dynamics, that allows for the study of the complex interaction of three sectors; population, food production & land productivity, and market is applied to investigate the causes of the problem. This analysis addresses the food security problem from the perspective of the three pillars; availability, access, and stability of food. Hence, food consumption, household income, food price, food production including, land productivity, rainfall effects, and the population dynamics are studied in depth based on a computer simulation model.

The model reproduces well the historical time series variables such as population, prevalence of undernourishment, production, yields, and price of cereals etc. And the result of the analysis reveals that both availability and accessibility of food has been the main constraints of the food security and are expected to prevail in the future. In our fifteen year perspective, whereas, the change in land productivity associated with land degradation, and the degradation effect on food insecurity has been insignificant. The already degraded land has contributed relatively little to the average productivity to the existing land. Moreover, a long term policy on land conservation, together with capacity building on the application of improved agricultural inputs, are expected to improve significantly the availability and accessibility of food for the population.

This thesis is organized in six chapters. The first chapter offers an overview of the literature covering related areas. Various concepts and definition of food security are discussed in the second chapter. In the third chapter, the dynamic problem, hypothesis and a detailed description of the model, sub-divided in three sectors, is presented. The fourth chapter includes the model validation tests and the comparison between the simulation results and historical data. The fifth chapter explains the future policy options and the test of policies under various scenarios. The conclusion and limitations of the study are presented in chapter six.

Chapter One: Review Literature

Researchers have attributed the food insecurity in Ethiopia to many inter-connected issues among them; an insufficient agricultural production, an imperfect market, and a rapid population growth that is disproportional to the agricultural production are pointed out most serious. In this section we discussed some of the literature reviewed by different scholars.

1.1 Attributes of Insufficient Agricultural Production

1.1.1 Drought

Agriculture has been the main economic activity of many Ethiopians for centuries. Around 80% of the population is employed in the agricultural sector and the main characteristic of Ethiopian agriculture is its dependence in rainfall. Awlache, S.B. et al. (2010) estimated that Ethiopia receives about 980 billion cubic meters of rain per year. Rainfall is the ultimate source of water in that it is a resource of agricultural production, and also surface water and ground water are feed by rain. Annual and seasonal rainfall distribution is highly variable and droughts are frequent in some parts of the country (Ersado, L. 2005, Bewket, W., 2009).

The limited production and productivity has permanently been attributed to insufficient rainfall. Although production depends on the amount of rainfall and distribution, much of the rain water is lost due to the absence of adequate conservation and ineffective water harvesting activities. It was estimated that from about 110 billion cubic meter annual surface water supply, only one percent is used for irrigation and hydro power (Chadhokar, A.P., 2003 Proceedings of the Food Security Conference, p.139).

According to the Central Statistical Agency of Ethiopia (CSA, 2008), the main characteristics of Ethiopian agriculture is the existence of two well-known crop production seasons called Meher (main rain) and Belg (short rain) seasons. There is a clear distinction between the terms Meher season and Meher season Crop as well as Belg season and Belg season crop. Meher season in the Ethiopian context is the long rainy season that occurs from June to September. This season is the most convenient (or ideal) growing condition for most of agricultural production and it offers the largest share of the cultivation areas, around 91% of the total cultivated area (Bewket W., 2009). Meher season crop is the crop that is harvested from September till February. In terms of cereal production an estimate of 95% of the production is resulted from the Meher season crop (CSA, 2011). On the other hand the Belg season is referred as small but timely, rainy season which normally occur from February to May. But it occurs only in limited areas of the country and provides the remaining 9% of the cultivation area. Belg season crop is the crop that is harvested during the months of March to August. In terms of production it contributes with not more than 5% of the annual production of the country.

1.1.2 Land Degradation and Fertility Decline

Degraded soils constitute a major constraining factor to agricultural production and contribute to the decrease in over-all agricultural production resulting from a decline yield of farm land. Ethiopia in particular is vulnerable for soil degradation and has the highest rate of erosion in Africa (Jolejole-Forman, M. C., 2012, Zelleke, G. et al., 2010)

Numerous researchers have pointed out the various factors contributing to soil degradation in Ethiopia. Zelleke, G. et al. (2010), Amede et al. (2001), Jolejole-Forman, M. C. (2012), and Keyzer M. et al. (2001) pointed out factors such as; soil erosion, complete removal of crop residues from farm land, use of animal manure as a source of fuel rather than source natural fertilizer to increase soil fertility, absence of appropriate soil and water conservation, deforestation, and population pressure. The use of animal dung and crop residues for energy instead of soil fertilization leads to the depletion of organic matters such as organic carbon and other nutrients like N, P, and K. A case study in the Bale highland of Ethiopia has shown that the burning of dung as a fuel instead applying it as manure has been estimated to reduce Ethiopia's agricultural GDP by seven percent.

Most of the agricultural production takes place in the highlands (above 1500 m). This is where 44 % of the total area is cultivated, where 95 % land under crop is located, where 90% of the total populations live, and where declining vegetative cover is very common. It has been estimated in three main forest regions of Ethiopia, 59,000 Ha forest per year has been converted in to agricultural areas (WBISP project 2004). The vulnerability of the land due to its topography (steep slope) together with poor cultivation practice causes soil losses to reach alarming level (Keyzer, M. et al., 2001, Amede, T. et al. 2001, Zelleke, G. et al., 2010).

Estimates indicate that the annual loss of agricultural soil varies from 3.4-84.5 tonnes per ha per year (Sonneveld, B. G. J. S. et al., 2002) and sometimes could be as high as 137 tonnes/ha/year or, in other words Ethiopia's top soil depth loss decreases by 4-10 mm each year (Sonneveld, B. G. J. S. et al., 2002, Zelleke, G. et al., 2010). To this regard, some researchers have argued that the net loss of soil on crop production occur in steep slope areas, with an account is given to the re-deposition of soil downstream. The area found in the downstream, benefits less from the coming soil compared with the area which lost the soil due to erosion (Sonneveld, B. G. J. S. et al., 2002).

Soil rehabilitation, reversing the lost fertility of the soil, can take many years, and in some cases the process may be irreversible. A 10 mm loss of top soil may be replenished naturally in approximately 200 years (Zelleke, G. et al., 2010, Yesuf, M. et al., 2005). The current development will therefore cause a significant loss in food security.

Several efforts have been made to estimate the cost of land degradation in Ethiopia. The estimates include costs associated with declining yield and loss of production (Yesuf, M. et al., 2005). Jolejole-Forman, M. C. (2012) found that land degradation reduces agricultural value by seven percent per year. Besides economic cost and fertility decline, land degradation also affects the livelihood of the farmers, including water quality and bio diversity. Some farmers have been subjected to internal migration due to the decline in the fertility of land that ultimately can no longer support their lives (Sonneveld, B. G. J. S. et al., 2002).

A more appropriate analysis to investigate the decline in yield of crops is to use soil degradation instead of land degradation because land encompasses the territorial bio-productive system that comprises soil, vegetation, other biota, the ecological and hydrological process that operates in the system (Yesuf, M. et al., 2005). The effect of soil erosion on productive capacity of soil depends on the depth and the quality of the soil remaining (not lost). The reduction in soil depth due to soil erosion is assumed to reduce the soil nutrients and the water holding capacity of the remaining soil.

Efforts have been made to estimate the effect of soil erosion on the yield of crops in Ethiopia. Yesuf, M. et al. (2005) has analyzed the various estimates and their methodologies in estimating the relationship between soil erosion and yield of farms. One of these is the estimate made by FAO (FAO 1986a), cited in Yesuf, M. et al. (2005). In this estimate the yield of cultivated land declines by 2.2 percent per year (criticized to be high) and sensitivity analysis of the estimate showed a yield decline for crop by somewhere between 0.6 and 3.4 percent per year for the low and the high scenarios respectively.

In more recent decades Bojo and Casseus (1995), cited in Yesuf M. et al. (2005), related the various rates of soil loss per year to declining yield. They estimated that the soil erosion would cause a decline in yield of 0.4 percent per year for all cereals. Weibe K. (2003) estimated main yield loss at somewhere between 0.01 and 0.04 percent per tons of soil lost. The units of measurement of yield losses between these two estimates is different as a result it is difficult to compare them in the same scale.

The decline in productivity could be an indication of the fertility decline in Ethiopia. The productivity has been found to be below its potential. For example, controlled for other factors in 2008/09 the average maize yield was 2.2 tons per hectore. This is less than the potential yield demonstrated by a farm trial resulting in 4.7 tons per hectore (Awlachew, S. B. et al., 2010). Similarly, the use of fertilizers applied is not as effective as the potential suggests. For example, the nutrient use efficiency (NUE=Kg yield per kg of nutrient) of maize in Ethiopia is 9 to 17kg of grain per kg of applied N while in Kenya and Tanzania, equivalent NUE values ranges from 7 to 36 and from 18 to 43 respectively (Zelleke, G. et al., 2010).

1.1.3 Agricultural Inputs and Coverage

Since the early 1990s Ethiopia has achieved improvements in the use of agricultural inputs to enhance production. Improved seed and fertilizer coverage has shown progressive increments to reach 4.7 and 39 percent in 2007/8 from 2.4 and 32.3 percent in 1997/98 (Zelleke, G. et al., 2010). But production growth has largely come from the expansion of cultivation areas. Evidently, there is a large potential for further improvement production through the use of inputs both by increasing amount to the optimal and increasing their coverage in the country.

1.2 Market Imperfection

The market plays an important role in improving food security, if it is used efficiently in such a way that an optimal allocation of agricultural production originating from the place of production is transported to the place of consumption. The market should provide adequate incentives to the farmers to increase output in order to ensure food security. Demeke, M. (2003, Proceedings of the Food Security Conference, p.5) has identified the attributes of the Ethiopian agricultural market. He pointed out the inadequate market information system with a weak bargaining power of farmers. Moreover, industrial processing sector is undeveloped. Also the infrastructure, such as road transportation is commonly poor. An estimated 75% of the farmers are more than half a day's walk from an all-weather road (Demeke, M., 2003 Proceedings of the Food Security Conference, p.5, Gabriel A., 2003, Proceedings of the Food Security Conference, p.217).

The market price of agricultural production is highly volatile. In the main harvesting season the price has been severely depressed to its lowest level because a large amount, around 79% (Demeke, M. 2003, Proceedings of the Food Security Conference p.5), of the annual production sale occur immediately after the harvesting season (January-March). When farmers are running out of stock on the other hand during the months of June to August, the price of agricultural production in general goes up. The volume offered at the cereal market drops sharply in the years of poor harvest causing the price to rise considerably.

The significant seasonal fluctuation of price is expected to discourage investment in the output market. Surplus producing farmers would be reluctant to make important investment in using inputs such as fertilizers and improved seeds in the presence of price instability.

Market opportunities of farmers have been influenced by a low level of urbanization in Ethiopia. Only 15 percent of total population lives in urban areas, which generates the main demand for agricultural production produced by the 85 percent of the population remaining in the rural area. Another issue, most importantly, is the vast majority of the populations in the urban areas earn very low level of income exacerbating the demand constraints of the food market. This pushes the price to a lower level Demeke, M. (2003, Proceedings of the Food Security Conference, p.5). Food demand is evidently low in the market compared to the production capacities. This has major influence on setting the price to a lower level than what it otherwise would have been.

The combined effect of relatively small demand and low purchasing power of consumers in the food market has resulted in low price setting. Further the low food price of food products doesn't provide adequate incentives to the farmers to increase output i.e. lower price of agricultural products causes lower investments in using agricultural inputs like fertilizer, improved seeds and pesticides which subsequently result lower yield and production. Thus this is the main causal loop that links market and agricultural production.

1.3 Rapid Population Growth

Rapid population growth has been regarded as one of the major causes of food insecurity in Ethiopia. The population has increased from 53.5 million in 1994, to 73.8 million in 2007 and currently it is estimated to reach 84 million (CSA, 2011 DHS). However, the population growth rate is declined from 3.1 percent in 1984 to 2.9 and 2.6 percent in 1994 and 2007 respectively.

Agriculture has been the main economic activity for most Ethiopians for centuries. Around 80 percent of the population has employed in the agricultural sector and agriculture contributes 43 percent of the growth domestic product or GDP (CSA, 2009). Despite the large proportion of population involved in the production of food, Ethiopia fails to feed relatively large proportion of population from its domestic production. Also and more importantly, the population do not have the productive capacity to earn wherewithal to commend its additional food requirements through commercial imports (Bikora, G., 2003, Proceedings of the Food Security Conference, p.15).

Studies have also shown that the health problems of a large proportion of the population has emanated from lack of adequate and balanced diet. Malnourishment, that encompasses undernourishment, diminishes people's ability to work, and care for themselves and their families and ultimately exposes them to disease. Children, pregnant and lactating women, and aged adults are the most vulnerable population to disease due to malnourishment (MH, 2003, Ali, M. et al., 2011).

Food production, mainly cereal production, constitutes the largest share of the total food production. Efforts have been done to increase food production in the last decade in Ethiopia. The cereal production of the main harvesting season (or Meher season, estimated

95% of the total production) was 82.69 million quintals in 1995 followed by a slight increase in 1996 to 86.93 million quintals before it reaches a local minimum of 64.98 million quintals in 1997. Subsequently the main season cereal production increases to 92.6 million quintals in 2000 and decreases to its lowest value, 63.49 million quintals in 2002. Then cereal production of the main season increases exponentially to reach its maximum of, 177.61 million quintals, in 2010 (CSA, 1995-2010).

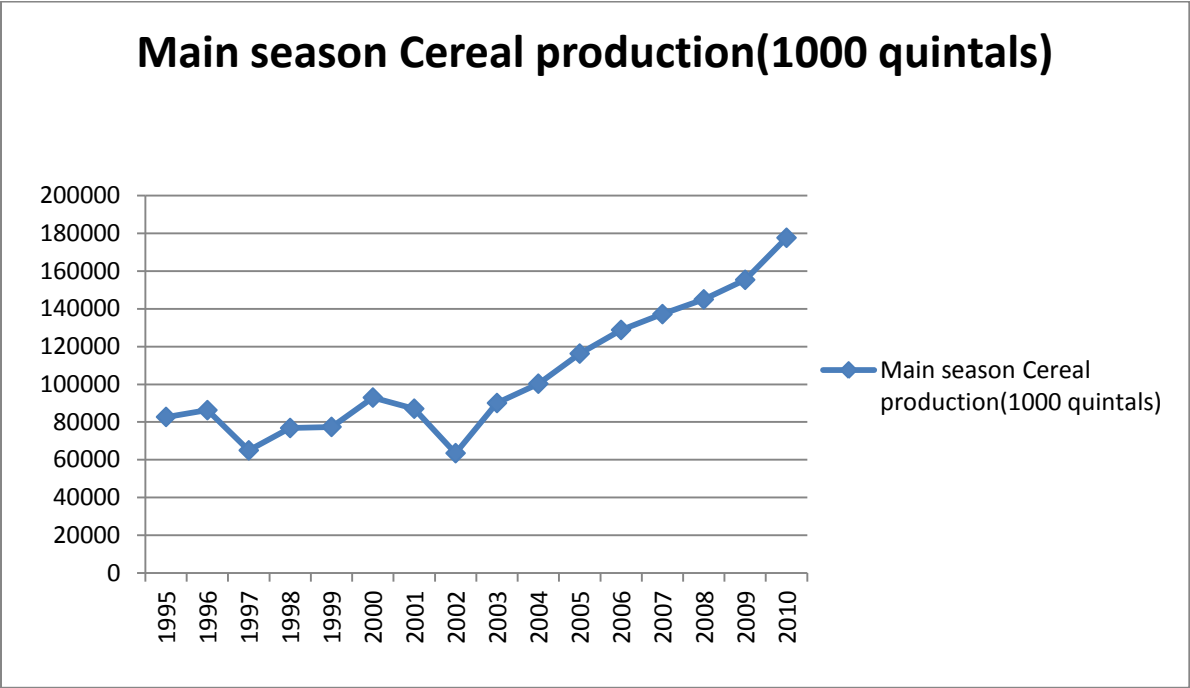

Figure 1: Cereal production of the main (Meher) season.

Source: CSA Agriculture sample survey

FAO (2000) cited in Sonneveld, B.G.J.S et al. (2002) estimated the population to reach 130 million in 2030. This growth in population had created enormous challenges for food supply to grow by 3.6 percent annually, if self-sufficiency has to be achieved, which is more than a twofold increment of the average growth rate of 1.4 percent.

²Figure 1 only represents only private (small scale) farmers production it doesn't include the cereal production by commercial farms.

Chapter Two: Food Security Context

2.1 Definitions and Concepts

The term food security has been used to describe whether the country has access to enough food to meet the dietary energy requirement of the population. National food security is used by some to mean self-sufficiency (Andersen, 2009) - that is, whether the country's agricultural productions meet its population consumption demand. This definition of food security at a national level focuses mainly on the production (or supply) part. But supply of food at national level does not assure accessibility of food at household and individual levels. Figure 2 shows the food security at different levels expressed in terms of supply, demand and need. To the left and the right of the graph, food security and insecurity conditions are depicted, respectively, at national/regional, household and individual levels.

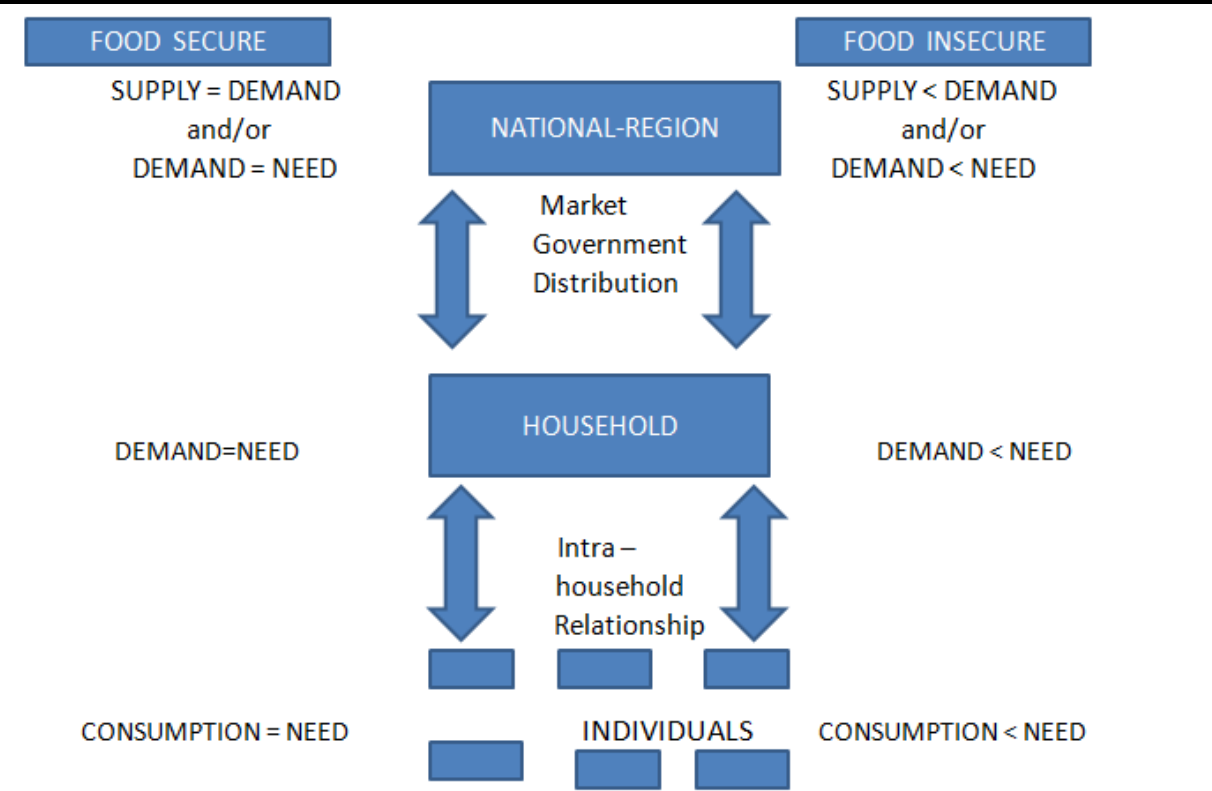

Figure 2: Levels of food security/insecurity

Source: Thomson, A. and Metz, M. (1999) cited in Giraldo D. et al. (2008)

The definition of food security which would be used in this research is in line with the food security definition adopted in the World Food Summit in 1996, Rome. This summit defined food security at individual household and national level as “Food security exists at these levels when all people, at all times, have physical and economic access to sufficient, safe, and nutritious food to meet their dietary needs and food preferences for an active and healthy life.”

The international community has accepted the definition of food security which is increasingly broad statement, of common goal and implied responsibilities. Most importantly, efforts have been to focus on narrower and simpler objectives around which to organize international and national actions (FAO, 2003). That is, a more operational definition has been required for measuring the extent of food insecurity as well as for intervening actions to alleviate the problem. Four pillars have been identified as components in an operational description of the food security definition. These pillars identified are availability, access, stability and utilization. FAO (2003-trade reforms and food security, and 2006 - Food security competitiveness), Messerle, R. (2011) and WHO (on line) has defined the four pillars as:

- Availability: refers the presence of sufficient quantity and quality of food produced domestically, supplied from import or food aids. Availability mainly focuses on the supply side of the food market.
- Access: refers to the presence of sufficient resources to obtain appropriate food for a nutritious diet. Access encompasses the potential of individuals both physical and economic like purchasing power, marketing, transport infrastructure, and food distribution systems to acquire food.
- Stability: refers the steadiness of both availability and access for food security. Stability may be seen from different aspects like: weather (soil degradation, water scarcity, and climate change), price fluctuation, natural and human induced disasters and socio political issues.
- Utilization: refers the use of non-food inputs as clean water, sanitation, etc. for the utilization of food supplies and access. Or in other words, it is the appropriate use of food based on knowledge of basic nutrition and care, in addition to adequate water and sanitation.

The World Food Summit was held at FAO Headquarters in Rome, Italy, from 13 to 17 November 1996,

In this research, we explain the causes of food insecurity from the perspective of the three pillars, availability, accessibility, and stability. We used one of the food insecurity indicators, prevalence of undernourishment, to describe these three pillars. We address the three pillars by studying the interaction of the three sectors; population, agricultural production (food supply), and market as indicated below.

- Availability: We study food production or generally food supply, and the food consuming population, to examine the availability of food in the country.
- Access: We study the food expenditure of the population together with the market conditions at which the price of food are set so that the economic access to food (purchasing power) is determined at individual level.
- Stability: The measure of stability is inherent to our method of identifying the problem. We used system dynamic methodology, which accounts for many variables and their interaction like; land degradation, rainfall distribution, market fluctuation etc. to analyze the different scenarios and able to investigate sustainability.

Chapter three: Research Problem and Hypothesis

3.1 Dynamic Problem

Food insecurity in Ethiopia has a long history. Since the 1970s there has been a series of production failures that has resulted in chronic food insecurity (Kaluski, D.N. et al., 2001). Ethiopia has been the largest recipient of food aid in Sub-Saharan Africa, and food security has been a main national concern. For many decades the country in general and people in particular have suffered from food insecurity problems. Rapid population growth, inconsistent weather conditions, and land degradation has contributed to the persistency of problem.

The Ethiopian government has widely reported the size of the chronically food insecure population in need of food aids either from domestic or international organizations and NGOs. As portrayed in figure 2, several millions of people, each year, over the last decades have been in need of immediate food assistance (chronically food insecure). In the last decade this number of people reached a maximum of 13.2 million in 2003, followed by a dramatic decrease in the following two years to reach 2.52 million in 2006. Subsequently, we saw a second maximum of 6.24 million in 2009 followed by yet another decline over the last two years (DRMFSS)

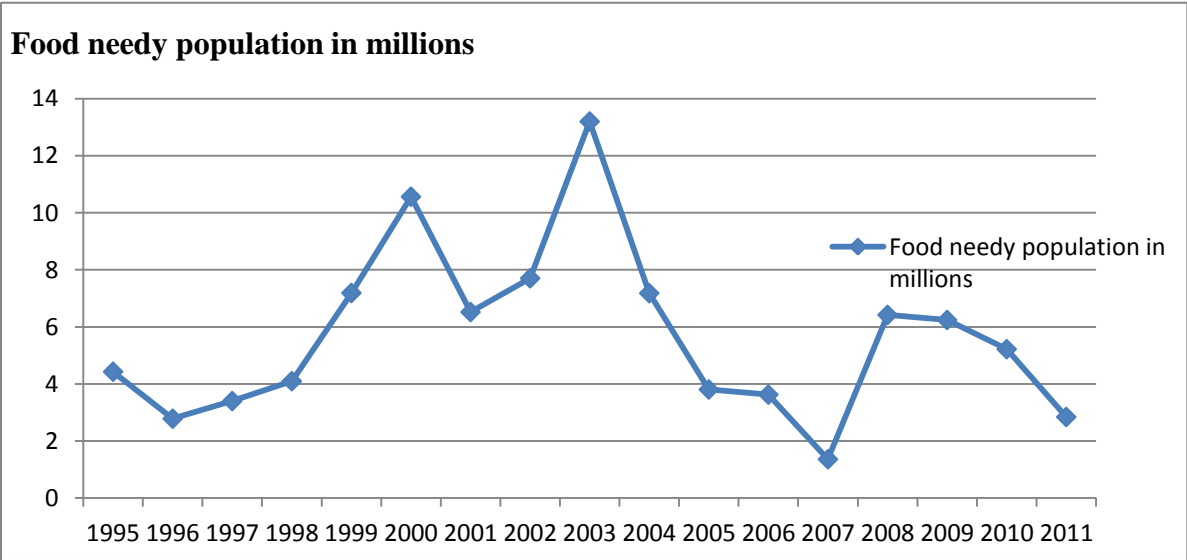

Figure 3: Food assistance needy population.

Source: Disaster Risk Management and Food Security Sector (DRMFSS)

However, within a wider perspective of the food insecurity, not only the chronic food insecurity, gives a different figure. For example, the undernourishment which refer the condition of people whose dietary energy consumption is continuously below a minimum dietary energy requirement for maintaining a healthy life and carrying out a light physical activity with an acceptable minimum body-weight for attained-height, has been very high (FAO-statistic division). Figure 4 shows the prevalence of undernourishment i.e. the percentage of the population that has been undernourished.

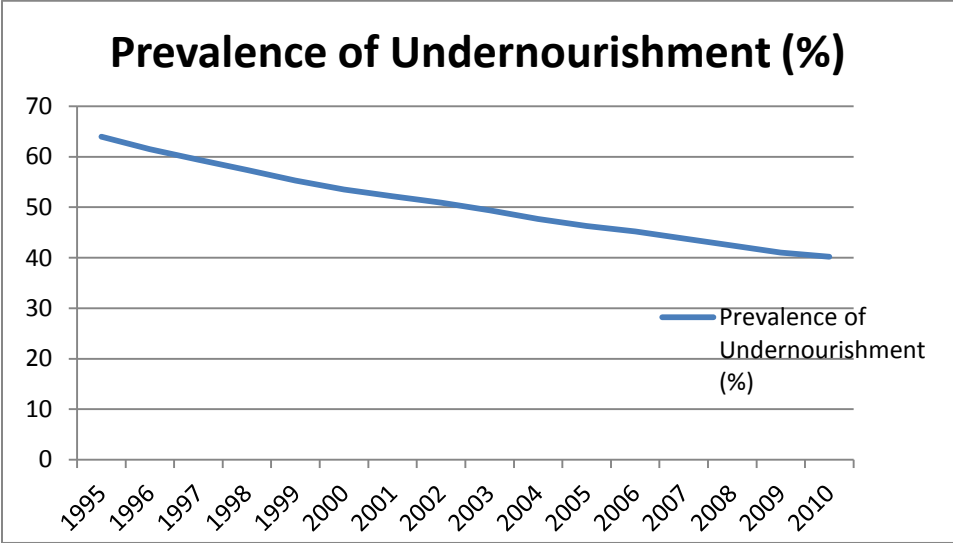

Figure 4: Prevalence of undernourishment

Source: FAO-food security indicators (2013)

From figure 4 above, in 1995 the prevalence of undernourishment (percentage of the population who were undernourished) was 64 percent. This represents around 34 million people. The prevalence of undernourishment has shown a progressive improvement (approximately linear decline) and reached around 40 percent (around 32 million people) in 2010. The progressive decline in percentage of undernourishment is not linearly transformed to a corresponding decline of the size of undernourished population since the population has been growing at the same time.

The main food insecurity indicator used to explain the problem behavior of food insecurity in Ethiopia is the prevalence of undernourishment. As a result, this study aims at describing the dynamics that has caused the prevalence of undernourishment for the last one and a half decades and to evaluate sustainable policy options alleviating the problem in the future.

In this research, we intend to investigate the cause (s) of food insecurity arising from the interaction of two or more of the following factors.

- ❖ Lack of sufficient agricultural production associated with drought or soil degradation
- ❖ The market imperfection and the lack of adequate household income
- ❖ Unbalanced growth of population and food production.

An integrated approach that study the dynamics of population, agricultural production (cereal production) and market is applied to investigate the cause (s) of food insecurity in Ethiopia. A system dynamic (SD) model is developed as a means to develop our understanding of the dynamics of food production, food distribution (market), and food consumption.

3.2. Hypothesis

The population of Ethiopia has been growing for the last decades. The number of babies per woman (if the woman lives all her fertile age) has decreased from around seven per woman in 1995 to four babies per woman in 2010. This fertility rate has been sufficiently large to increase the population. The growing population has been causing a growing demand for food consumption. Therefore, both a growing supply (physical access or availability) and accessibility (purchasing power) of food required to keep the momentum of the growing consumption has made it a challenge to feed the total population. However, the availability and accessibility of food has been governed by different mechanisms. As a result, both availability and accessibility have been limiting the acquisition of sufficient food for consumption.

The availability and the accessibility of food are equally important to the population at household and individual level in determining the actual consumption. Both the purchasing power and the actual food supplies have been the main cause for the high percentage of undernourishment. The larger the purchasing power, the larger would be the amount of food purchased for consumption. This would imply relatively small numbers of people are undernourished. Similarly the larger amount of food available in the market, the larger amount would be purchased and result in small number of people undernourished.

The prevalence of undernourishment is one of the main indicators of food insecurity which represents the proportion of the total population that is undernourished (who receive an amount of food whose calorie is continuously below the minimum daily calorie requirement). Thus, the tighter the constraining factors, accessibility or availability, the lower would be the consumption. That, subsequently, results in a relatively high prevalence of undernourishment. The undernourishment, however, causes an improper functioning of the body, diseases, and premature deaths or low life expectancy which over time decreases the population (MH 2003, Ali, M.et al.2011, Gebremariam, A.et al., 2005, p. 131-164).

The growing population demands an increasing supply of food from a domestic production (mainly from Meher production). As a result, the supply of food must increase through either the intensification of cultivation land or the increase in the yield of cereals. Hence, both the cultivation land and the yields of cereals have increased significantly since early 2000. However, the increase in the cultivation land has been practiced through the depletion of the natural resources such as forest and grazing land, and poor land management practice has been the characteristic feature of Ethiopian farming. The existence of poor land management practice along with soil erosion gradually causes the cultivation land to lose its topsoil. This results in a decrease in water retaining capacity, and a decrease in productivity. After a long time, the cultivation land into non-fertile land. Hence the increase in cultivation land with the presence of poor soil management results in an increase in the conversion of the land to non-fertile land. The non-fertile land requires a considerable amount of time return to a fertile state. Therefore, additional cultivation land has been a demand so as to replace the land lost in degradation. This has been experienced in the resettlement program of the government. There has been a mechanism that farmers use to slow down land productivity caused by the soil erosion e.g. through temporarily fallowing the land for some time (maximum of five years) so that it recover its productivity.

As the land has become non-fertile, the productivity has decreased. On the other hand, the new land that is being acquired from potential arable land is highly productive and the increase proportion of this land causes the average yield to boost. Moreover, the yield of cereals has not only resulted from the increase potential productivity of the land, it is also governed by the application of improved technologies such as improved seeds and fertilizers. The relative increase in coverage of these inputs, together with the increased share of productive land, has caused an increase in production.

The production of cereal results from the multiplication of cultivated land and the yield of the land. This has been the main inflow into the cereal inventories. The larger the production rate the larger is the inventory and shipments (or availability). Also, the larger the inventory could imply the lower the price of food (in the case of surplus). The part of the shipment that has been sold in the market by producers generates revenues that again may be used for investment in agricultural inputs so as to increase productivity. However this is a balancing process that it counteracts this effect. An increase in agricultural inputs causes an increase in production and over time increase cereal inventories. But the increase in inventories causes a decrease in price, which as a consequence causes a decrease in revenue obtained from sales. This results in a decrease in the purchase of agricultural inputs.

The desired food consumption, materialized in the purchasing power, called the desired effective food consumption, is one of the main determinants of actual food consumption. This means that, all the desired food consumption which is based on the minimum calorie requirement has actually not been acquired for consumption. Rather only the part of desired food consumption which is purchased upon the availability of food in the market, is consumed.

The accessibility of cereals that is based upon the average per-capita budget compared to the current price of food, determines the actual amount of food desired to purchase from the market. Hence the price of food has a significant effect on the desired purchased food / desired effective food consumption, and shipment. Higher the food price causes the amount of desired food purchased to decrease that causes the desired effective food consumption to decrease, and reduce shipments subsequently result in relatively high percentage of undernourishment.

A large share of the farmers' production is being used by the farmers themselves for their own food consumption. The increase in productivity of the land creates more availability and accessibility food opportunities for farmers. This significantly contributed to the increase in per-capita food consumption. Hence increase in land productivity improves (decreases) the prevalence of undernourishment.

3.2.1 Causal Loop Structure

Causal loop diagrams (CLD) are important tools for representing the feedback structure of the system that causes a problem under investigation. There are a number of feedback loops in the food security analysis which links across and within three sectors; population, land use & land productivity, and the market. The symbols (R), (B), and (C) represent reinforcing, balancing, and conserving loops respectively (Sterman, J., 2000). Figure 5 represents the main causal loops representing the feedbacks within and across the sectors.

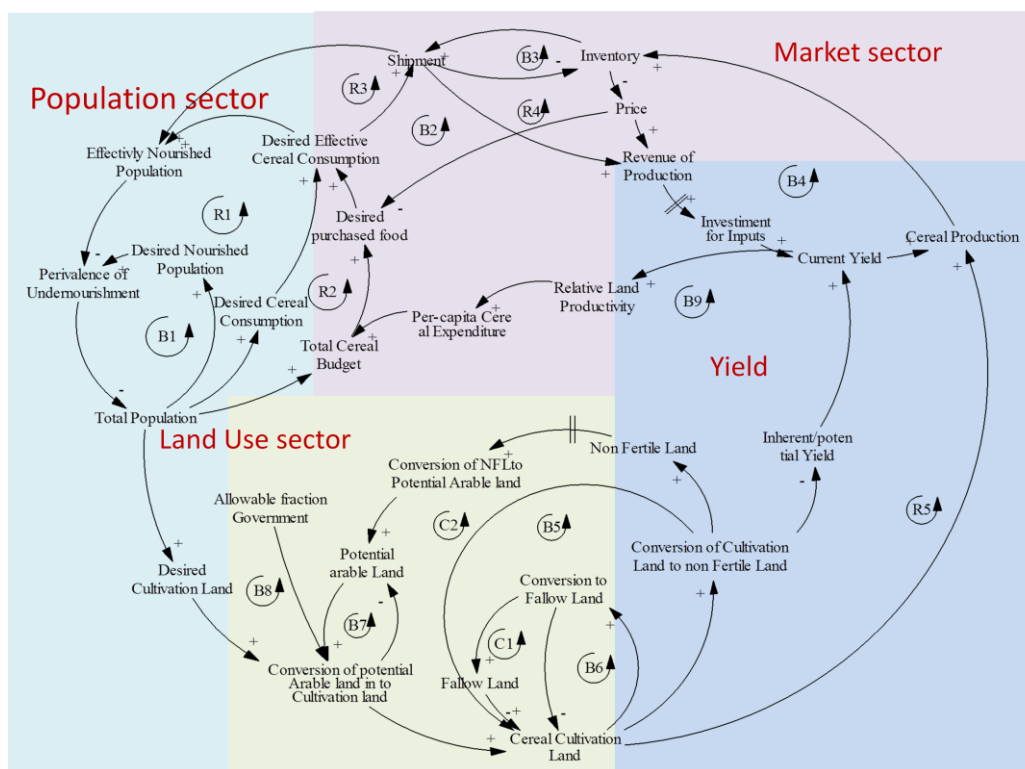

Figure 5: *The main causal loop diagram representing the feedbacks of the explanatory model.*

In this section, the explanation is organized in loops i.e. we describe each loop by hiding the remaining unexplained loops.

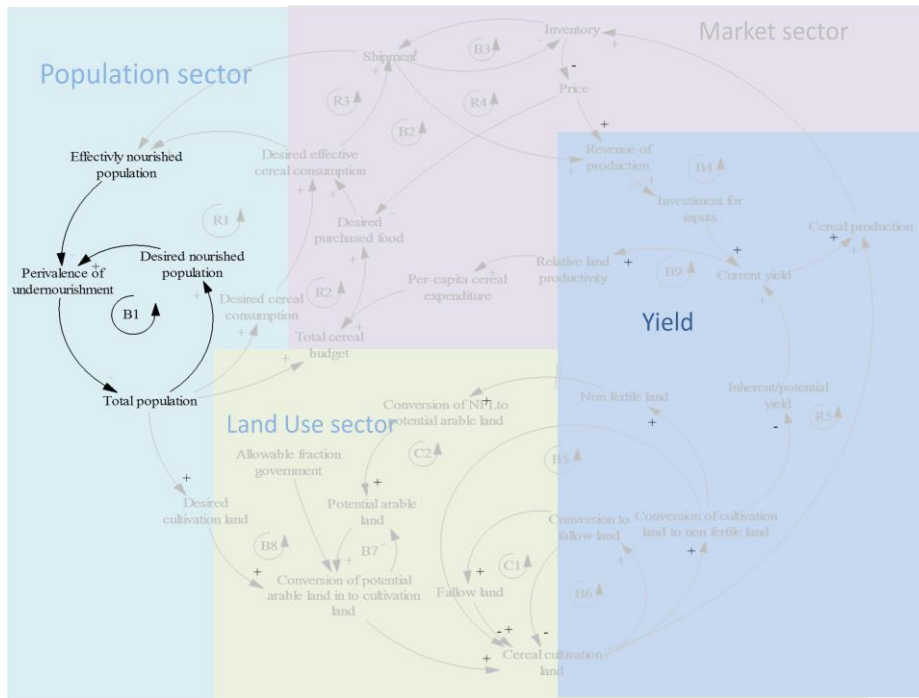

Figure 6: Balancing loop B1

We start with the explanation of causal loops in the population sector. The balancing loop B1 represents the interaction of the total population (or desired population nourished) with the prevalence of undernourishment. With the presence of the effectively nourished population, the prevalence of undernourishment represents the proportion of the total population who are undernourished (desired nourished population – effectively nourished population), total population. As the population has been growing, the increase in the total population (or desired population to nourish) causes an increase in the prevalence of undernourishment. Moreover, the increase in the prevalence of undernourishment causes over time decrease in the total population.

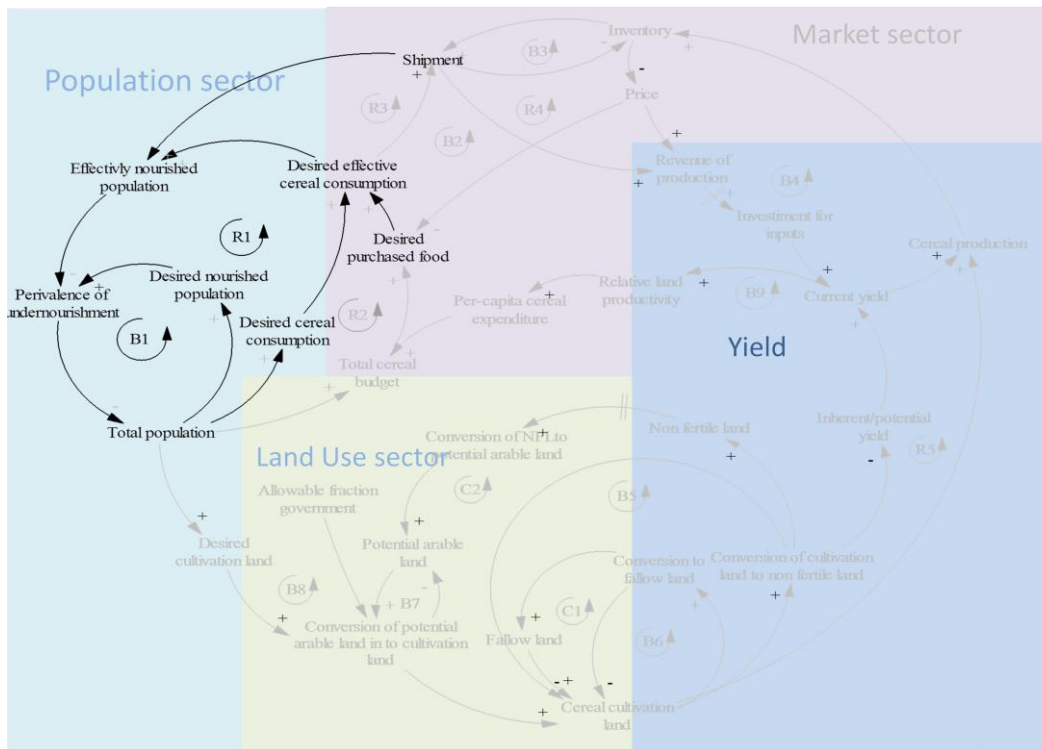

Figure 7: Reinforcing loop R1

Now we examine the determinants of the effectively nourished population by way of shipment (shipment for consumption) and desired purchased food in a loop called R1. The reinforcing loop R1 represents the interaction between the total population, the desired cereal consumption, the desired effective cereal consumption, the effectively nourished population, and the prevalence of undernourishment. The desired food consumption generated by the population is computed based on the recommended minimum daily calorie requirements of an average person. But only that part of the population who has a purchasing power will reach the desired cereal consumption. Hence, the desired purchased food is a constrained to the desired cereal consumption. Desired effective cereal consumption is the desired cereal consumption materialized by the purchasing power. The increase in population causes to increase in the desired cereal consumption and in the desired effective cereal consumption provided that there is sufficient purchasing power. Subsequently, the increase in desired effective cereal consumption causes an increase in the effectively nourished population, provided there is sufficient shipment for consumption. With the existing structure of B1 this closes the loop R1.

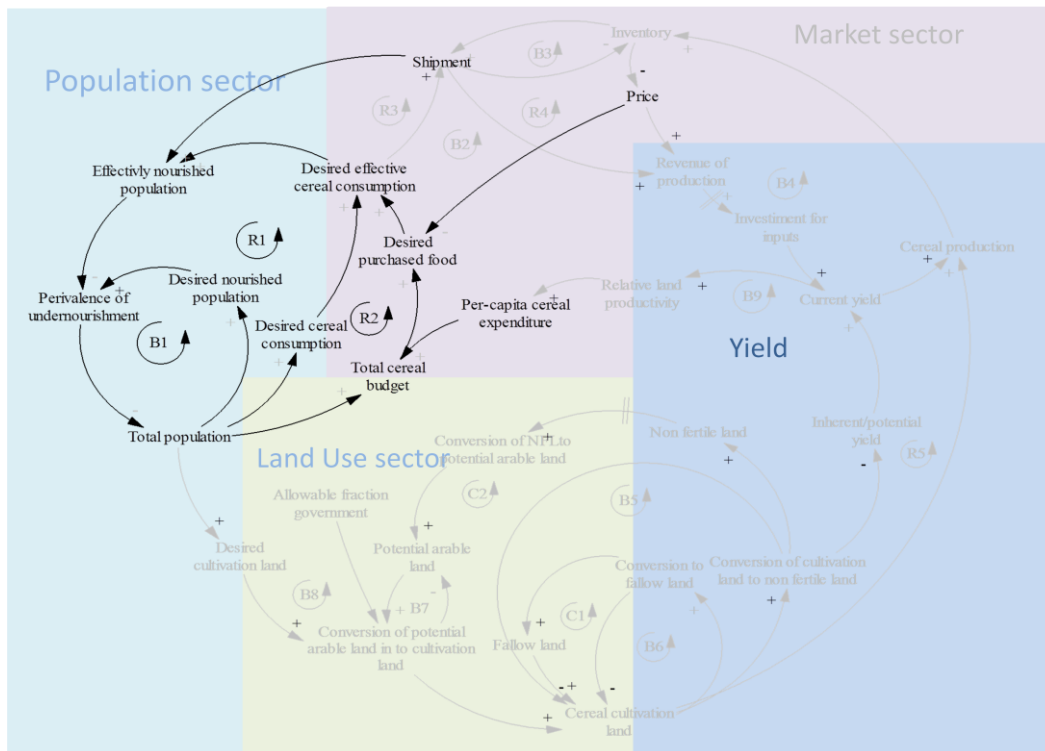

Figure 8: Reinforcing loop R2

Now we explain what determines the desired purchased food in the system. To do so, we need two additional inputs, price and per-capita cereal expenditure, to characterize the desired purchased food / cereal. The reinforcing loop R2 governs the accessibility of food. It is through the food budget divided by the price we obtain the amount of desired food purchased. R2 represents the desired cereal consumption materialized by the purchasing power. Based on the per-capita expenditure and the total population the size of the total cereal budget is determined. The desired effective cereal consumption is the minimum of the desired purchased food and the desired food consumption. The larger the total population causes the total cereal budget to increase with the use of per-capita cereal expenditure as a converter. The increase in the total budget causes an increase in the desired purchased food which increases the desired effective cereal consumption. With the existing structure of R1 this closes the loop R2.

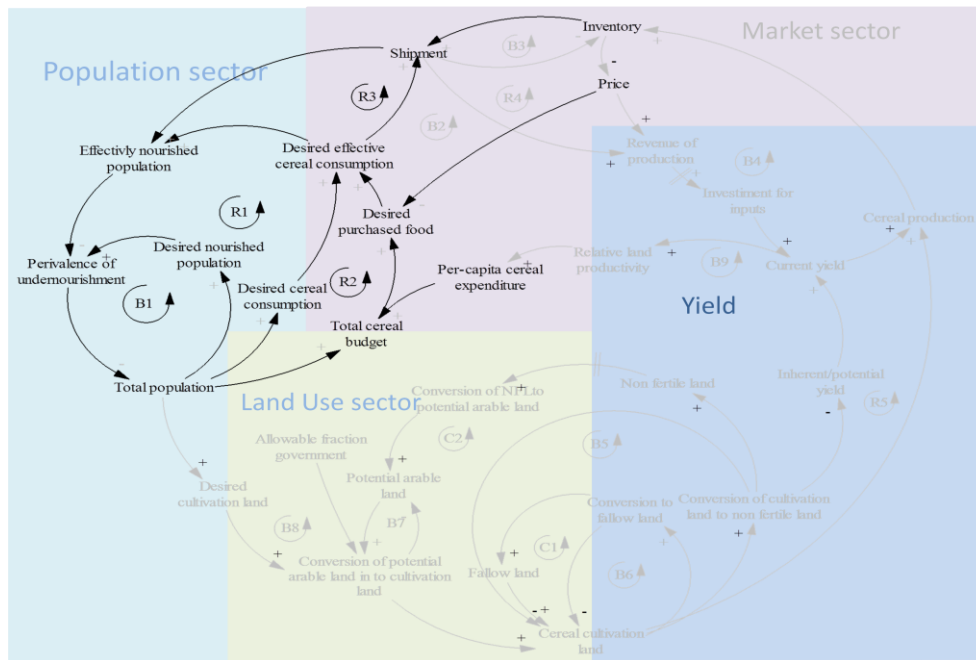

Figure 9: Reinforcing loop R3

The actual food consumption of the population is determined based on the availability of food, i.e. whether there is a desired effective cereal consumption and sufficient food in the market, equivalent to the desired effective cereal consumption. Hence, the availability of food in the inventory is an important determinant of the shipment. The reinforcing loop R3 represents the interaction of the population and the market sectors. Particularly, this loop governs the availability of food. Through shipment an additional link from the desired effective consumption to the shipment closes R3 with the existing structure of R2. An increase in the total population causes an increase in the desired effective cereal consumption through the total budget, -which also increases the shipments. The increase in shipment causes an increase in the effectively nourished population.

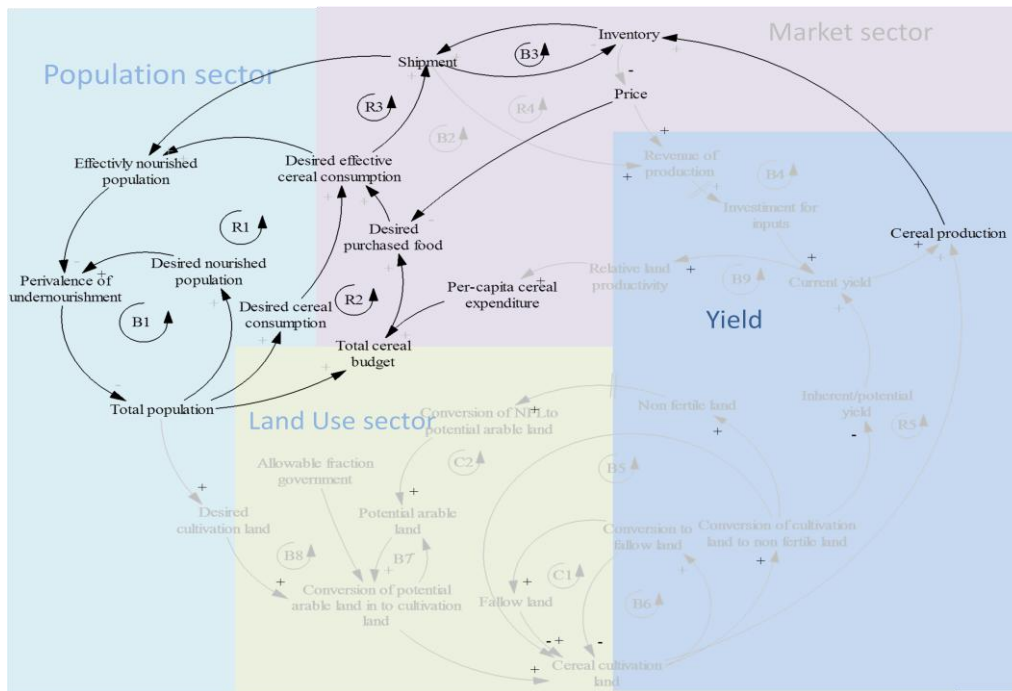

Figure 10: Balancing loop B3

We used the inventory of cereals to explain the shipment in R3, the balancing loop B3 represents the interaction between the inventory and the shipment. The inventory is mainly filled by the Meher cereal production. I.e. if there is no sufficient production delivery that substitutes for the shipment for consumption, then the inventory will be depleted that will influence the shipment- resulting in limited consumption. The increase in inventory, causes an increase in shipment. But, as the shipment depletes the inventory, the increase in shipment, over time, causes a decrease in the inventory.

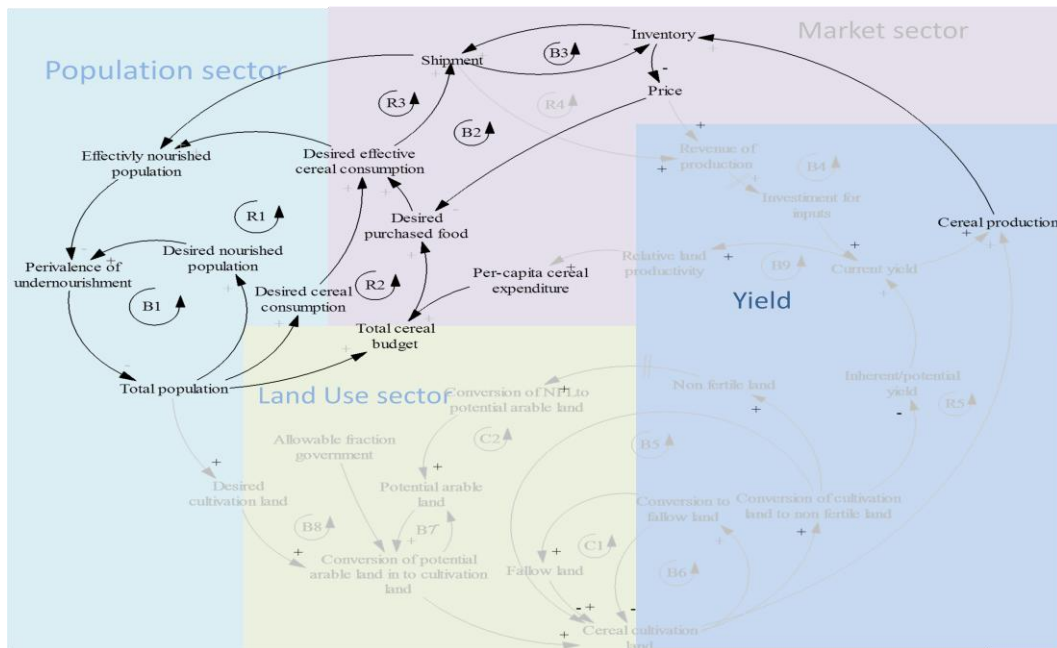

Figure 11: Balancing loop B2

We used the desired purchased food when we described the feedback loop R2. The desired purchased food is mainly influenced by the budget and the price of the food. Moreover, the price of food is partly determined by the availability of food in the inventory. If there is a surplus of food in the inventory, then the price will drop / while increases when there is insufficient food in the inventory. The balancing loop B2 represents the interaction between price, desired purchased food, desired effective cereal consumption, shipment, and inventory. Increasing the desired effective consumption causes an increase in shipment which, over time, causes a decrease in the inventory. The decrease in inventory causes an increase in the price which results in a decrease in the desired purchased food, and subsequently a decrease in the desired purchased food causes a decrease in the desired effective cereal consumption. This closes the loop B2.

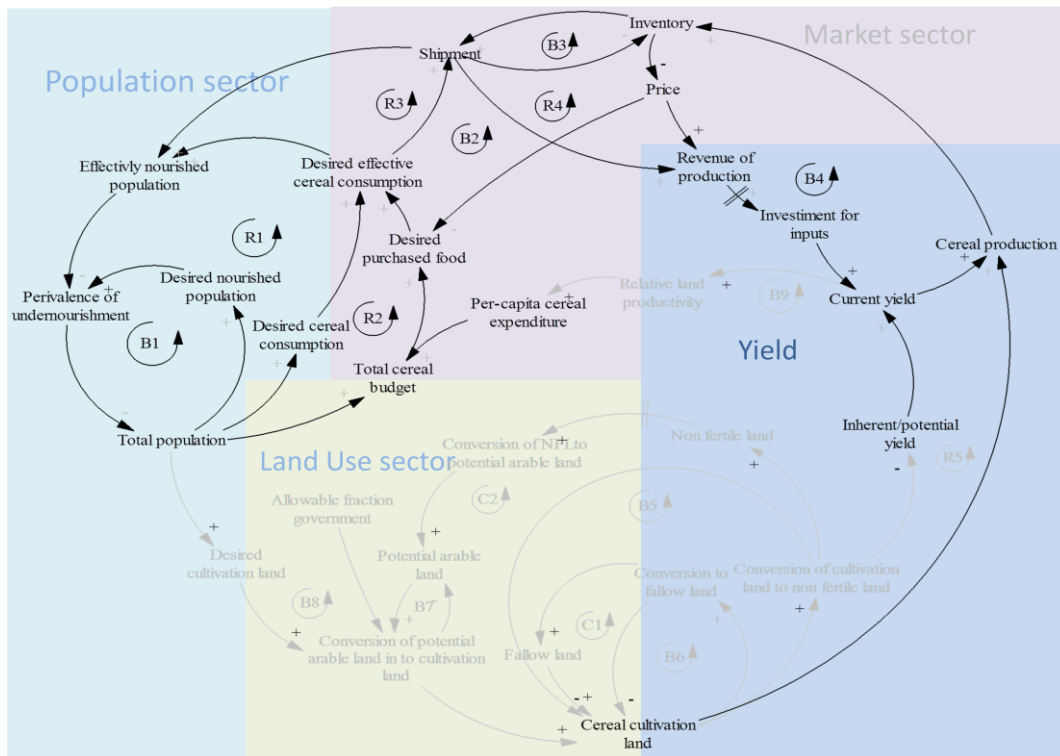

Figure 12: Balancing loop B4, and reinforcing loop R4

The balancing loop B4 and the reinforcing loop R4 represent the interaction between the market and land productivity through the involvement of price and shipment. Price and shipment generate revenues for farmers and part of the revenue is used for investment in agricultural input. The revenue of farmers can be increased in two ways, (a) resulting from the increase in producer price (which is governed by B4) or (b) resulting from the increase in shipments (sell shipments governed by R4). In the balancing loop B4, the increase in price causes an increase in revenue from production, and then, in investment for input. In the presence of inherent / potential yield of the land, the increased investment in agricultural input causes an increase in current yield. The result of this increase in current yield and the total cultivation land is an increase in the cereal production and, consequently the inventory. But the increase in inventory has two effects; (a) it causes the price to diminish which results in a decrease in revenue, and (b) causes an increase in shipments sold which causes revenue to increase. Hence, in the first case (a), the balancing feedback loop B4 closes. In the second case (b), the reinforcing loop R4 is closed.

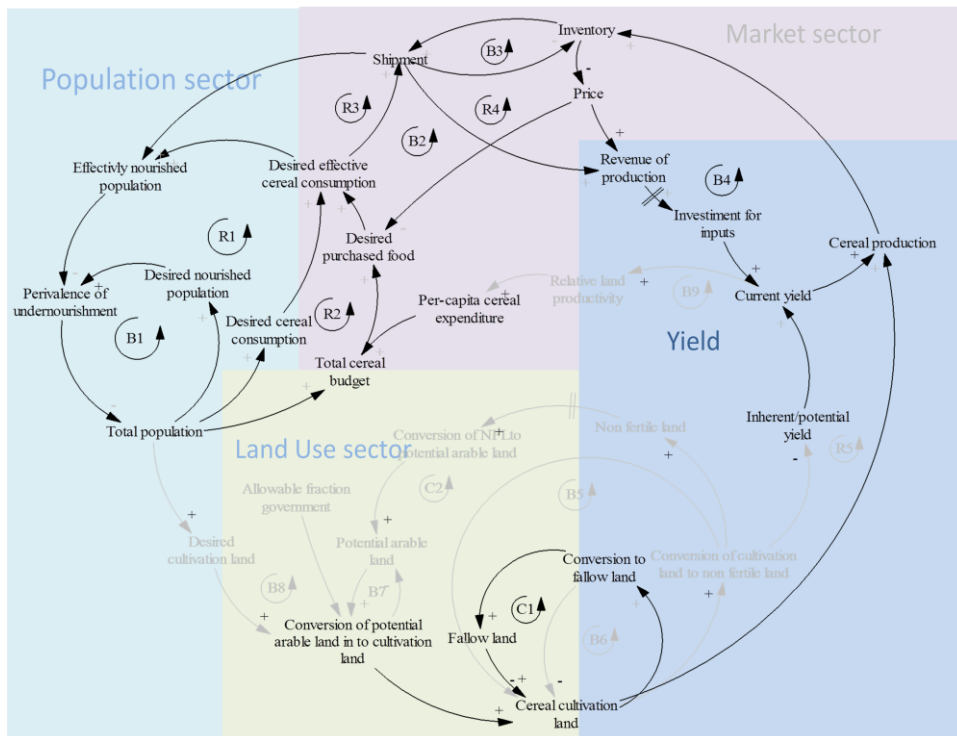

Figure 13: Conserving loop C1

In the land use sector, there are two major conserving loops C1 and C2 and three minor loops representing the most important dynamics. The conserving loop C1 represents the conversion of cultivation land in to fallow land. In the feedback loop C1, the fertile land recycles between two stocks, cultivation land and fallow land. The fallowing process helps the land to keep its productivity. The increase in cereal cultivation land causes an increase in the conversion to fallow land. That subsequently, causes an increase in the cereal cultivation land. Through temporary fallowing, the land maintains its productivity but the process does not add additional land to the system, hence this loop conserves the land.

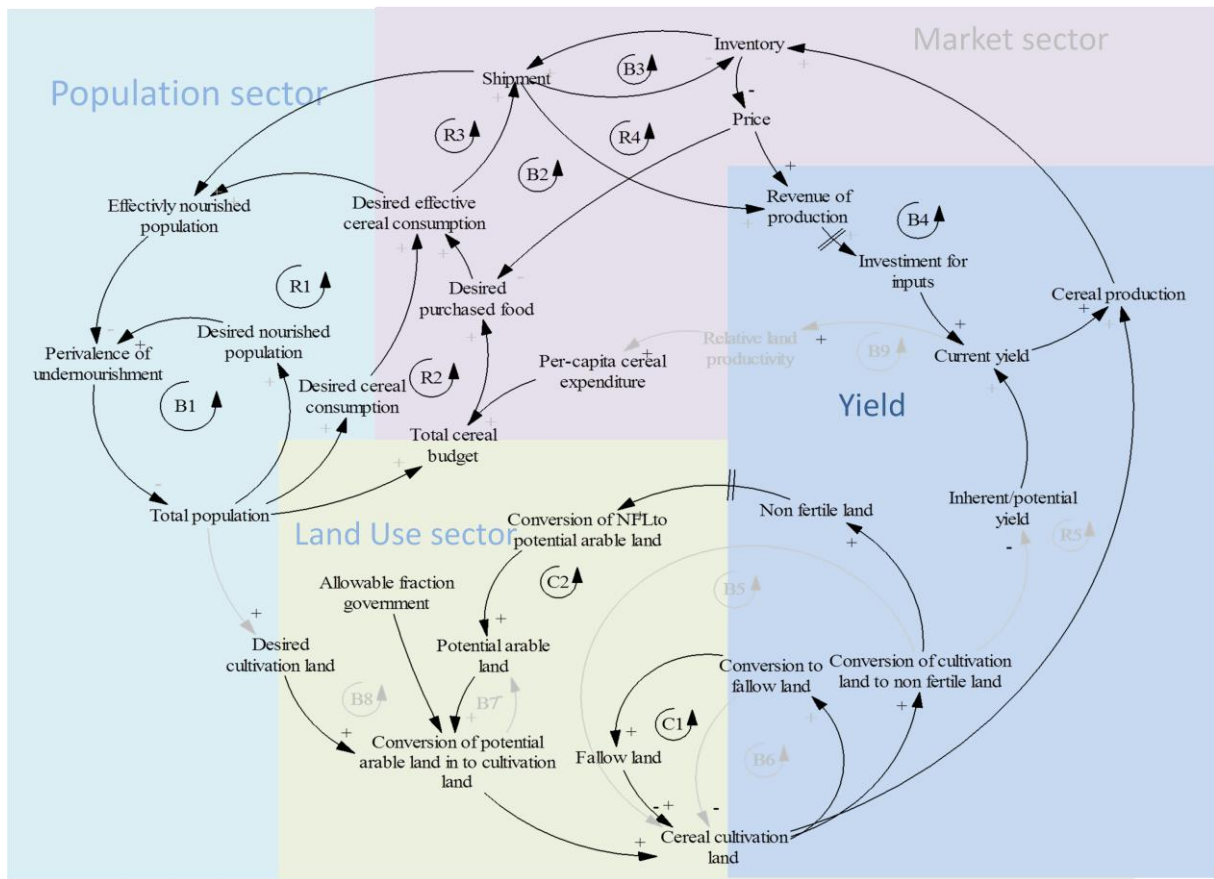

Figure 14: Conserving loop C2

The conserving loop, C2, represents the gradual soil degradation process through which the fertile cultivation land loses its productivity after many hundred years, become non-fertile land and, after a longer delay, again becomes productive land. The cereal cultivation land increases due to the increase in cultivation land demand generated by the growing population and by the government's willingness to allocate land. The increase in cereal cultivation land causes an increase in the conversion of cultivation land into non-fertile land. The increase in the conversion of cultivation land into non-fertile land over time, causes an increase the non-fertile land. After a very long delay, the increase in the non-fertile land causes an increase in the conversion of non-fertile land into potential arable land which then leads to an increase in the potential arable land. Subsequently, the increase in potential arable land increases the cereal cultivation land. This closes the loop C2. Also this process (recycling process) is a conservation process through which the land moves through the various stages of degradation and eventually becomes fertile after very long delay.

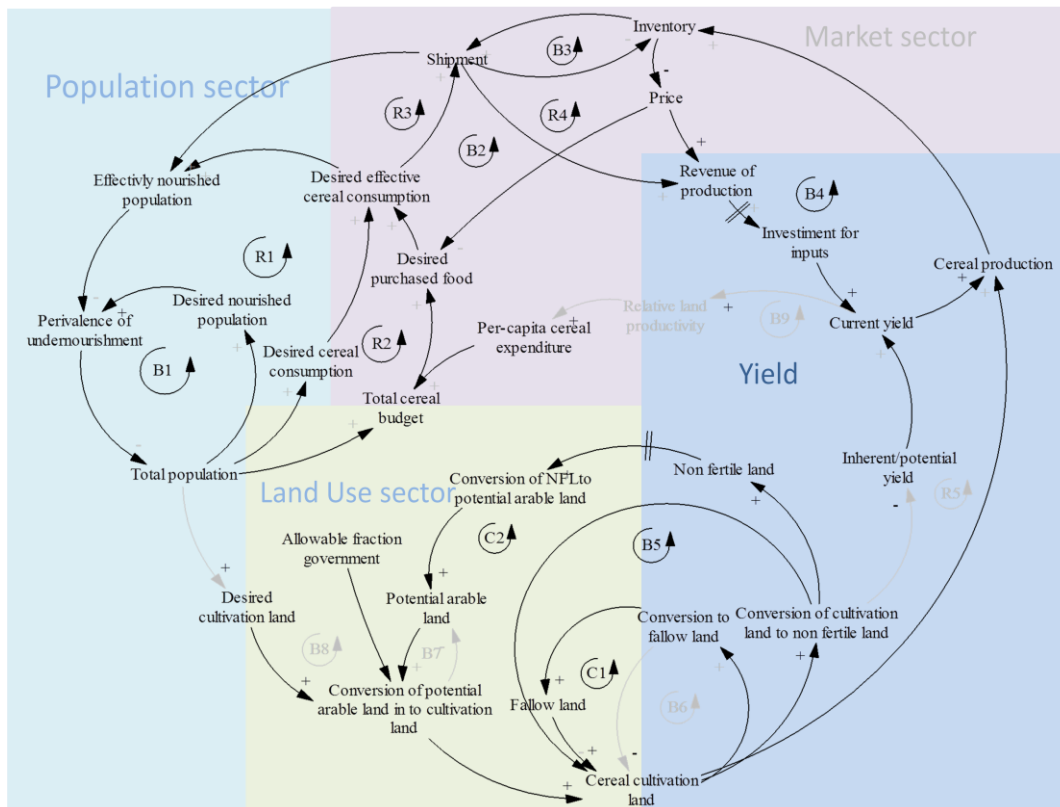

Figure 15: Balancing loop B5

In the gradual, natural, process of converting cultivation land into non-fertile land through land degradation, there is an important minor feedback loop. The balancing loop B5 represents the feedback between cultivation land and the conversion rate of cultivation land into non-fertile land. The increase in cultivation land causes an increase in the conversion of cultivation land into non-fertile land. However the increase in the conversion of the cultivation land, over time, causes a decrease in the cultivation land, thus closing the loop.

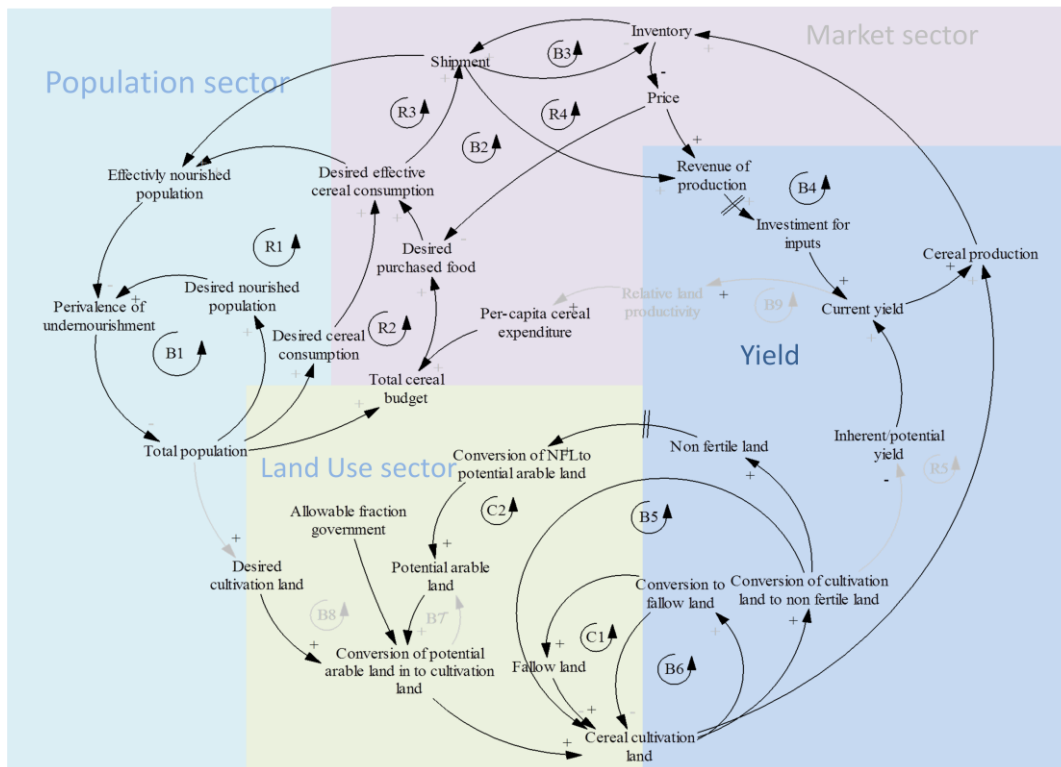

Figure 16: Balancing loop B6

In the fallowing process, a fraction of the cereal cultivation land has been converted into fallow land in addition to the fallowing of land resulting from rainfall deficient. Hence, there is an important feedback between the cultivation land and the conversion rate of cultivation land into fallow land. The balancing loop B6 represents the interaction between the cultivation land and its conversion into fallow land. The increase in the cereal cultivation land causes an increase in the conversion rate into fallow. While the increase in the conversion rate to fallow, over time, causes a decrease in the cereal cultivation land.

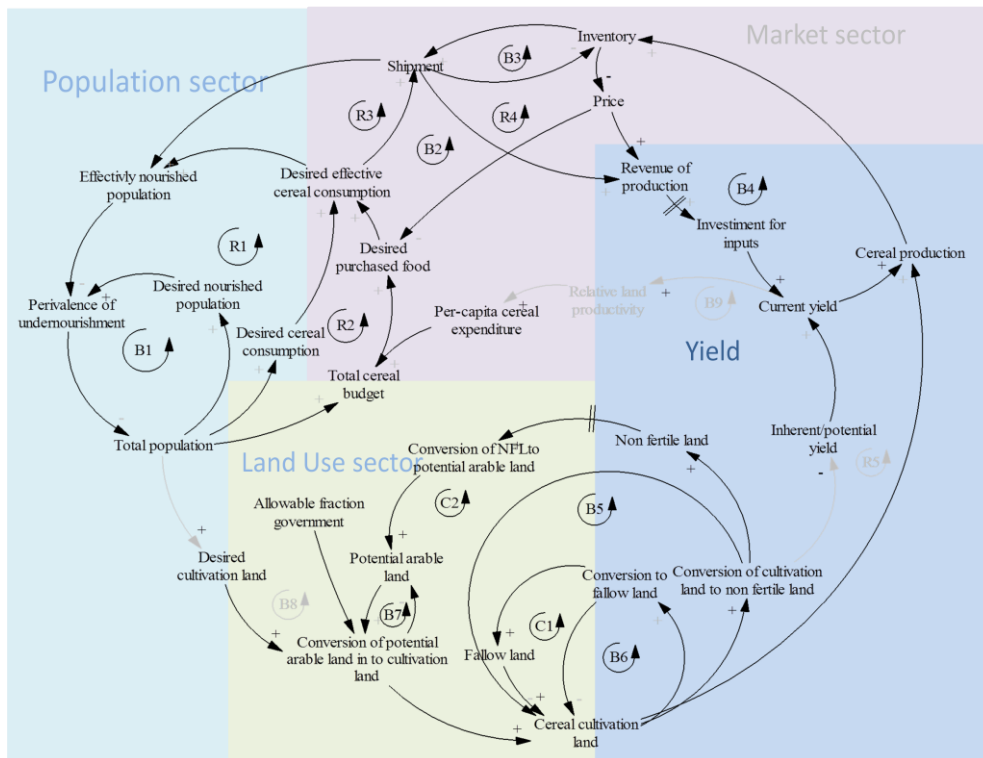

Figure 17: Balancing loop B7

The balancing loop B7 represents the depletion of the natural resource for cultivation land depending on manifested in the desired cultivation land and for the government to allocate land. In the balancing loop B7, the increase in potential arable land causes an increase in the conversion of potential arable land into cultivation land, depending upon the desired cultivation land of the population and the willingness of the government. To allocate land the increase in the conversion of potential arable land into cultivation land, over time, decreases the potential arable land. It should be noted that, we have at our disposal only a limited amount of potential arable land. The more we deplete or use of it now, the less will remain for the future. Hence there is a limit to growth. For environmental reasons, it is also recommended to protect this resource for future generations.

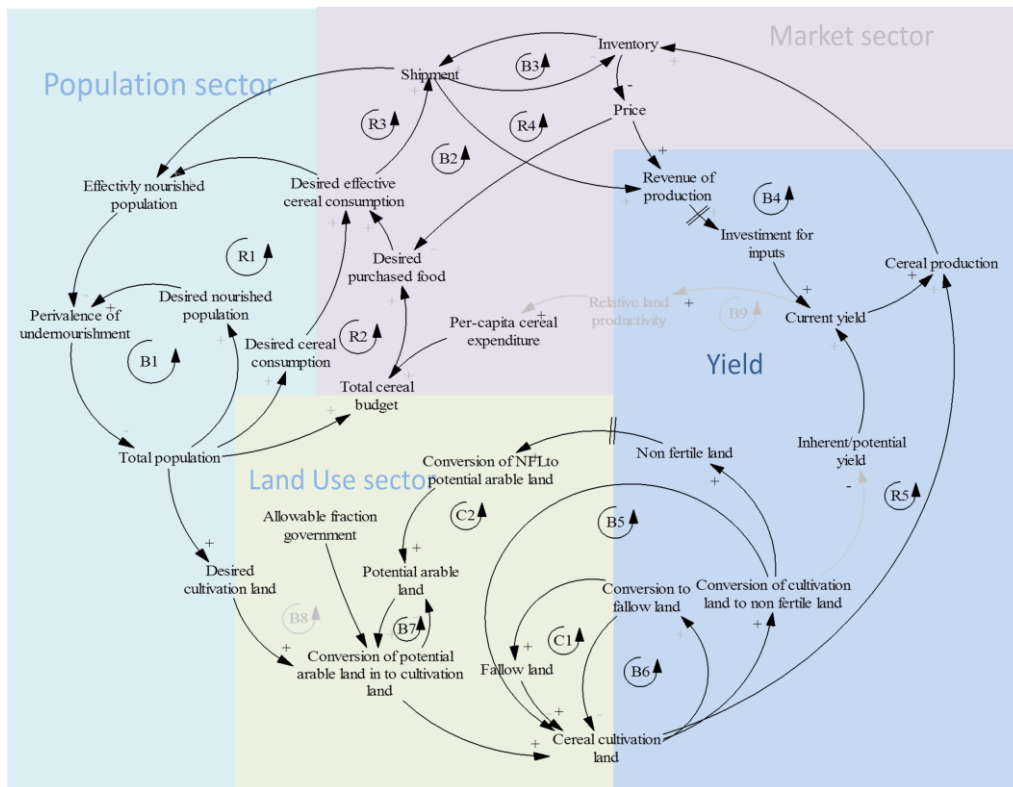

Figure 18: Reinforcing loop R5

One of the mechanisms used to increase the production of food / cereals has been the intensification of cultivation land. The reinforcing loop R5 represents this mechanism. In this loop, the increase in total population, over time, causes an increase in the cultivation land through the increase in desired cultivation land, followed by an increase in the conversion of potential arable land into cultivation land. The increase in cereal cultivation land, in turn, causes an increase in the cereal production. Together with the existing structure, this closes the loop R5.

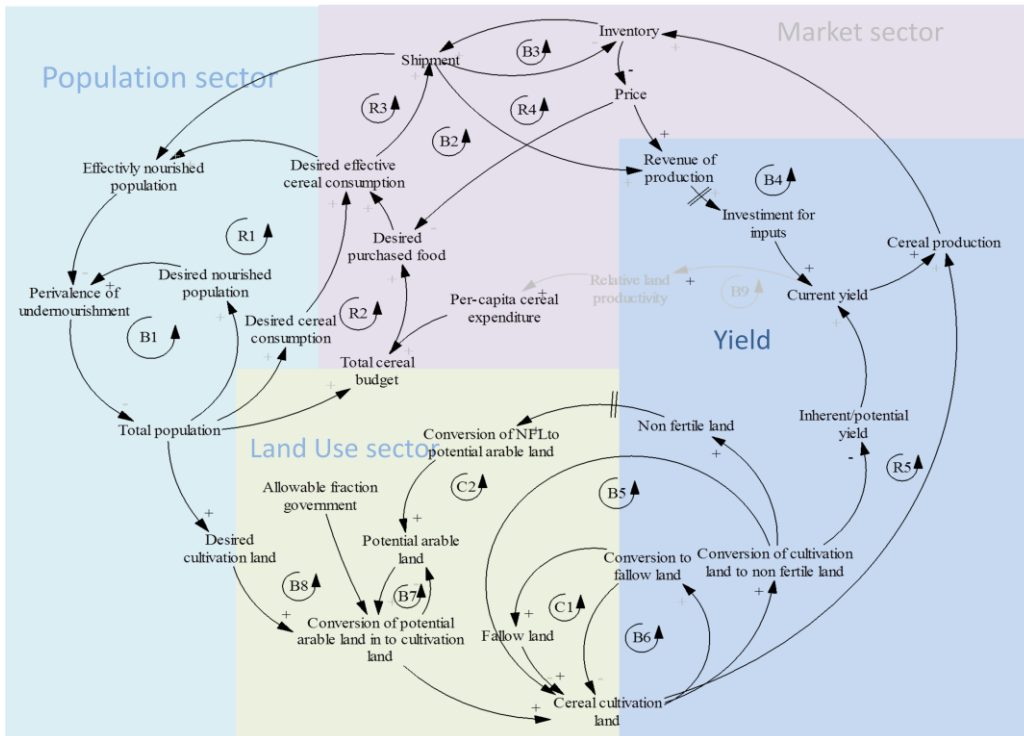

Figure 19: Balancing loop B8

The degradation process and its effect on land productivity is represented by the balancing loop B8. The larger cultivation land causes an increase in the conversion of cultivation land into non-fertile land. That diminishes the inherent / potential yield (productivity). In turn the diminishing in inherent yield causes a decrease the in current yield. Together with the existing structure this closes the loop, B8.

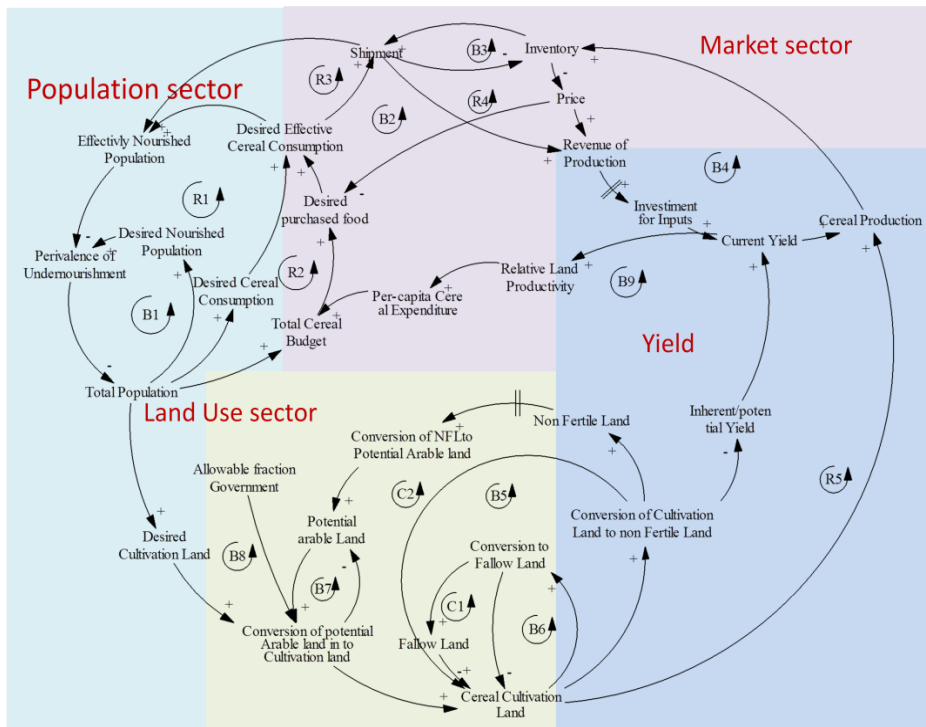

Figure 20: Balancing loop B9

The balancing loop B9 represents the interaction between relative productivity of land and food consumption. The per-capita expenditure computation includes the farmers' cereal consumption, i.e. consumption of food is literally a part of their expenditure. (Consumers spend to consume and producers consume their own production). Under real conditions, an increase in the productivity of the land creates an opportunity for farmers to access more food for consumption. Hence, the increase in the relative productivity of the land causes an increase in the per-capita expenditure (through actual consumption). In the balancing loop B9, an increasing the current yield causes an increase relative productivity, which causes an increase in the per-capita cereal expenditure, and in the total cereal budget. With the existing structure already explained, this closes the loop.

3.2.2 Stock and Flow Structure

Stocks and flows are fundamental to the dynamics of complex systems. The food security problem involves complex characteristics such as: time delays, non-linearity, feedback cycles, stocks and flows which influence the understanding of the main structure. In this section, we thoroughly present the model structure that has caused the dynamic problem. The model is sub-divided in to three main sectors; population (3.2.2.1), agricultural production which includes land use & land fertility dynamics (3.2.2.2) and Market (3.2.2.3). Sectional structure of the model is presented together with the explanation as space is the constrained to put the whole structure once.

3.2.2.1. Population

Ethiopia is one of the developing countries in Sub-Saharan Africa which has one of largest population. Currently the population is estimated to be around 84 million. Even if the total fertility rate is exhibiting a declining trend, it remains high around four babies per women in 2011 (World Bank). As a result, the population has been growing at a rate above 2% every year.

The need for modeling the population dynamics as a basis for examining the food consumption demand of the population is evident. The food consumption of the population results from a multiplication of the size of population and the average per capita food consumption requirement to satisfying the minimal energy to live a healthy life. Also, the study of population dynamics allows us to investigate the dynamics of land use. The population pressure has been attributed as a cause for an expansion of cultivated land through the conversion of potential arable land.

For easy representation and study of the population dynamics, an aggregate model is used. We divided the population into four cohorts, the children cohort (age 0-4), the school age cohort (age 5-14), the fertile age cohort (age 15-49), and the elderly population cohort (age above 49). Using the female fertile population fraction and total fertility rate, we define “Birth Rate” to be the inflow to the children cohort. We also use average life expectancy to define the death fractions of the cohorts. The death fractions and net migration fraction are used to define the death rates and migration rates of each cohort (out flows). Figure 21 shows the stock and flow structure representation of the underlying the population dynamics.

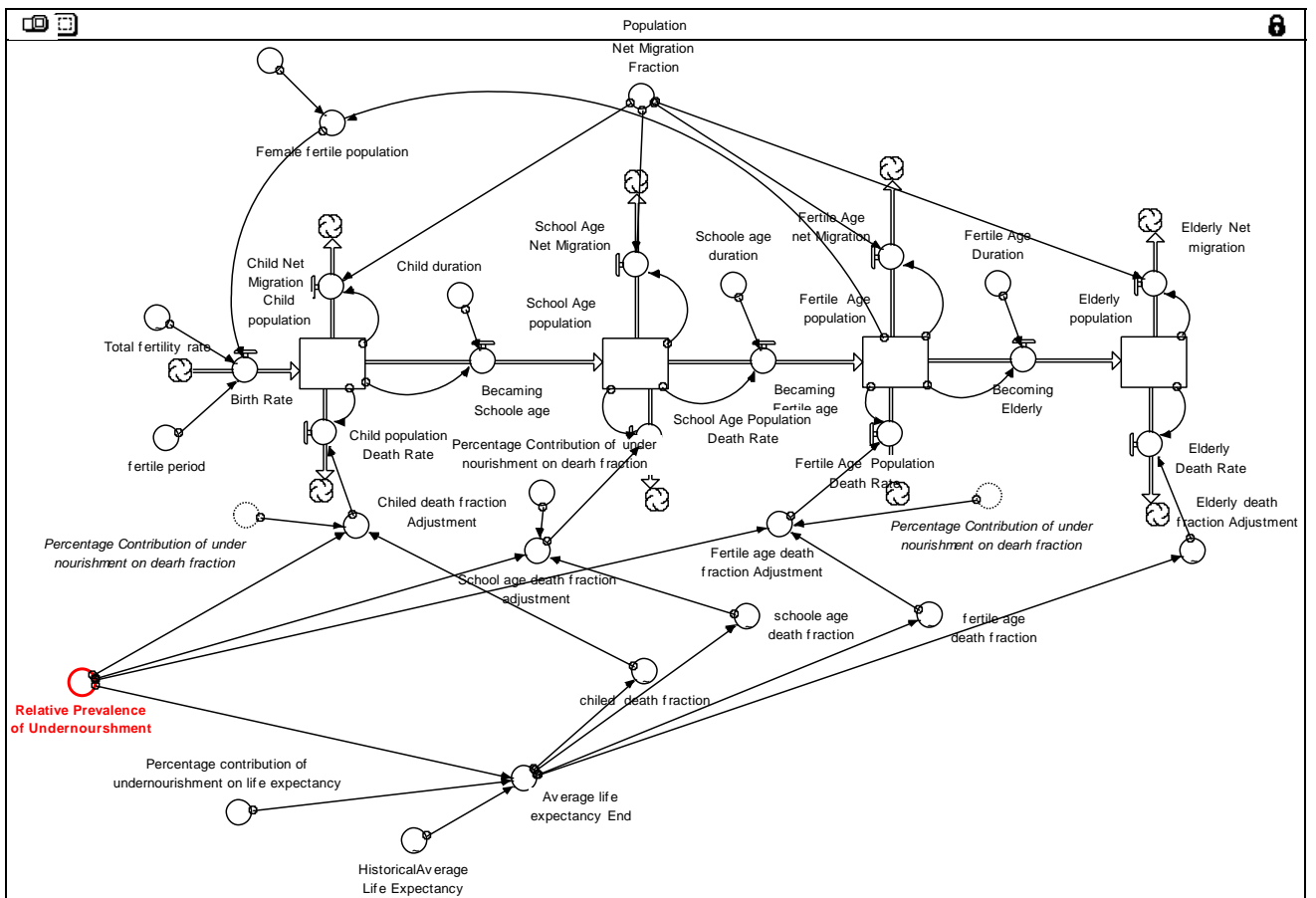

Figure 21: Stock and flow diagrams of population dynamics

3.2.2.2 Agricultural Production

3.2.2.2.1. Land Use Dynamics

Agricultural production (food) is facilitated by the use of productive land, the required agricultural conditions, and the addition of inputs to the system such as fertilizers and pesticides. The amount of agricultural production depends directly on the size of the cultivated land and the fertility of the land (up on the addition of inputs). As a result, it is necessary to study the dynamics of land use and its fertility to explain the dynamics of food production.

Four main dynamics have been observed in the land use for the cultivation of cereals. These changes encompass the conversion of potential arable land to cultivation land, conversion of cultivation land in-to fallow land and the vice versa, transformation of cultivation land in to non-fertile land, and, lastly, the reverse process (sometimes may be irreversible) of converting non-fertile land in to potential arable land. These changes have different causes and different time horizons that govern the transformation.

Associated with the four main dynamics, four stocks have been identified. The stock of *potential arable land*-consists of land that is suitable for rain-fed agriculture, the stock of *cereal cultivated land*-consists of land currently being cultivated, the stock of *fallow land*-consists of cultivation land that is temporarily fallowed for a short period of time for rehabilitation purpose or due lack of rainfall, and the stock of *non- fertile land*-consists of land highly eroded and that become useless for cultivation after an intensive period of cultivation.

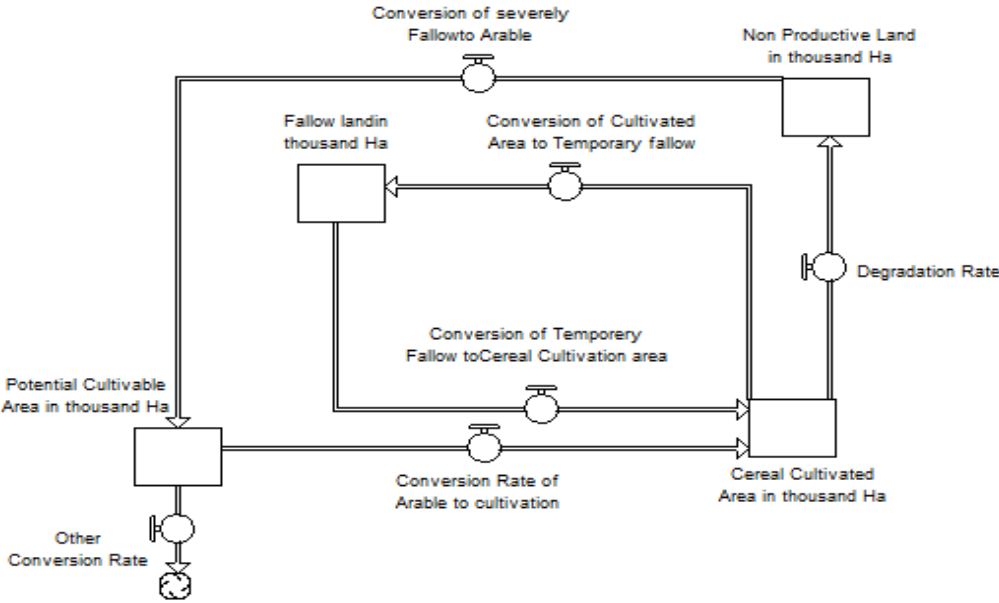

Figure 22: Stock and flow diagram of the main land use model

Traditional land management systems have been dependent on the availability of potential arable land for agriculture. The need for access to new land for cultivation has been very common in countries like Ethiopia that experience a high population growth and a significant loss of cultivation land due to land degradation. When more people need to produce their food and make a living from land, potential arable land has been continuously used for cultivation. The existence of a potential arable land for expanding cultivation land is basic for agricultural planning of the country.

Besides the distribution of potential arable land in the regions it is available and marginal potential arable land nearby in case of scarce potential arable land, resettlement of a large number of people has been common. Spontaneous and formal resettlements of people from drought, degradation and disaster affected areas to more suitable areas (mainly suitable land) have been noticed (Denboba, M. A. 2005).

Even though resettlement of people from agriculturally unsuitable areas to agriculturally suitable and potentially rich areas has taken place for emergency (lifesaving) reasons, resettlement has been also considered a viable policy alternative to relax the environmental stress, bringing about lasting solution. However, poor practices of soil management and water conservation, together with other factors, have resulted in degradation of the new settlement's environmental resources (Denboba, M. A. 2005).

Currently, one of the most cost effective policies in alleviating the food insecurity in Ethiopia is resettlement. For instance, in the main four regions of Ethiopia: Amhara, Oromia, SNNP (Southern Nations Nationalities People) and Tigray the number of people resettled in the last eight years is presented in the table below.

year	Regions				Total number of settlers
	Amhara	Oromiya	SNNP	Tigray	
2003	37788	116592	5826	36348	196554
2004	33834	189846	85104	143394	452178
2005	191562	41070	16440	0	249072
2006	51030	18210	21402	0	90642
2007	43218	89586	40407	0	173211
2008	4242	1252	6109	0	11603
2009	20599	0	0	0	20599
2010	15556	15225	0	0	30781

Table 1: Number of settlers in the four main regions of Ethiopia

Source: Federal food security bureau of Ethiopia.

Evidences show that with the resettlement strategy of insuring food security of a chronically food insecure population resulted in the conversion of potential arable lands to cultivation areas in the short run. And with the absence of good soil management and water conservation practices in the new area, intensive cultivation results in the degradation of the natural environment particularly, soil and fertility, which, ultimately leads to food insecurity in the long run. This process with a significant delay, conceptually coincides with the ‘shifting *the burden* archetype³.

In Ethiopia, data on land use, particularly on potential arable land and fallow land is scarce and the existing data are inconsistent. Data of potential arable land should be adjusted for non-agricultural land use, protected lands etc. (for nature, like parks), and for human settlements. Bot A.J. et al. (2000) has estimated the potential arable land of Ethiopia for the year 1994 to be 42945000 hectares. Another estimate of potential arable land presented varies from 30 to 70 million hectors (Awlachew et al. 2010). Bikora, G. 2003) claimed that out of 111.5 million hectares, 66 percent (approximately 73 million hectares) was estimated to be suitable for agriculture.

One of the main dynamics in the use of land is the change in potential arable land in to cultivation land. Cultivation areas, particularly cereal cultivation areas, have been expanding for the last one and half decades. The growth rate was relatively stagnant in the end of 1990’s but it has been significantly higher in the early 2000. The increase in cultivated land is attributed to the use of potential arable land for cultivation as reviewed in the literature. Figure 23 portrays the cultivated land in Ethiopia for production of cereals in the main rainy season.

³Archetypes in general are diagnostic tools which insight into the underlying structure from which the problematic behavior originates. Shifting the Burden archetype in particular illustrates the tension between 1) the attraction (and relative ease or low cost) of devising *symptomatic solution* to a visible problem and 2) the long-term impact of *fundamental solution* (takes long time, patience, requires relatively large up-front commitment of funds) aiming at underlying structure that is producing the problematic behavior at the first place. Selecting the *symptomatic solution* rather than the *fundamental solution* produces instant gratification (short-term solution) and has an effect to perceive little need to pay any more attention to the *fundamental solution*. However, in the long run the problem gets much stronger (aggravated) than at the first time and needs relatively more efforts to alleviate (Braun, W. 2002).

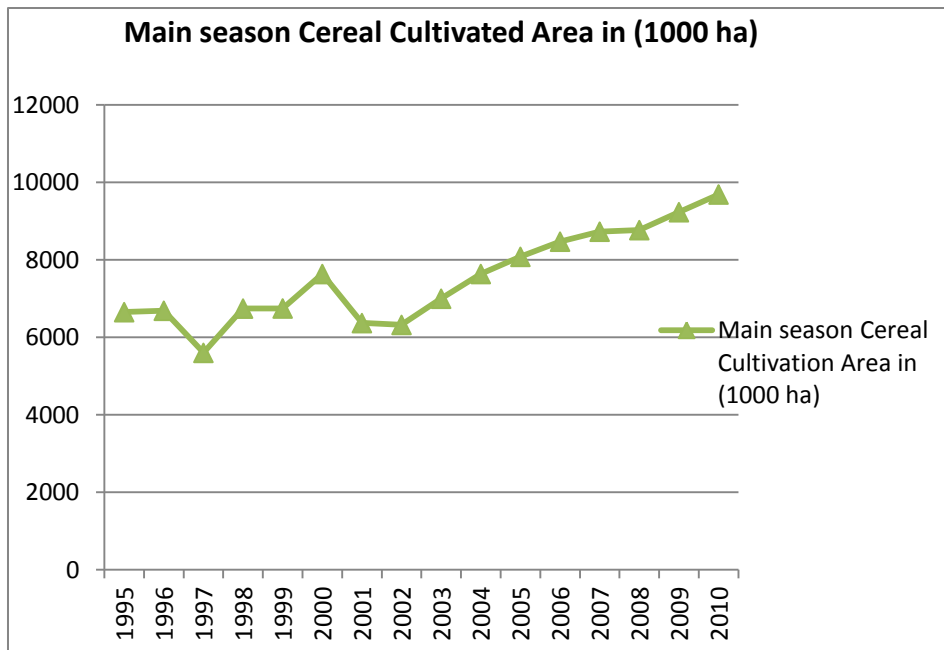

Figure 23: Main season (Meher) cereal cultivation area

Source: CSA (Central Statistic Agency)

The second most important dynamics lays on the transformation of fertile cultivated land in to non-fertile land by way of gradual degradation process. Soil erosion is a natural process of land degradation through which losses in soil productivity comes due to physical losses of the top soil, reduction in rooting depth, and removal of plant nutrients. Accelerated soil erosion causes the erosion rates to exceed the threshold soil erosion rate due to the human activities, has led to severe soil degradations. When the soil loss rate exceeds the soil formation rate (threshold soil erosion value) the net physical loss of top soil cause severe degradation in the long run, that ultimately change the fertile cultivated land into non-fertile land. Poor land use, soil management, and farming (or cropping) practices are the main anthropogenic factors governing the accelerated soil erosion (Denboba, M. A. 2005, Eaton, D. 1996).

Land degradation in Ethiopia is mainly caused by water. Degradation by water or wind evidently removes the top soil, plant nutrients, and organic matters. Plant nutrients and organic matters may be restored at some cost and by the use of some technology. However, replacing lost soil matter in addition requires the land to be out of use for many thousands of years which is impractical. Rehabilitation of loss organic matter requires inputs which are very costly and estimated to be 10-50 times greater than the cost of preventing it from degradation (Denboba, M. A. 2005).

It has been reported that the amount of cultivated land decreases due to the conversion of cultivated land into either fallow land or non-fertile land. FAO National Review Report (2002), cited in Berry, L. (2003, p.4) claimed an average cultivated land loss of 30,000 ha per year, with over 2 million ha already severely damaged is recorded in Ethiopia.

Within the stock of cultivated land there are several stages of degradation. A slow process of soil erosion causes declining potential yield of the cultivated land throughout the stages of degradation. It is on its way through these stages that the fertile cultivated land finally ends up non-fertile or unproductive land. Bot A.J. et al. (2000) has presented the definition of the various degree of land degradation as:

- Light: somewhat reduced agricultural productivity.
- Moderate: greatly reduced agricultural productivity.
- Strong: biotic functions largely destroyed; non-reclaimable at farm level.
- Extreme: biotic functions fully destroyed; non-reclaimable.

A measure of soil degradation that encompasses the degree of land degradation is the measure of soil *degradation severity*. It combines the various degree of land degradation with its extent to result in a differentiation into twenty classes (Figure 24 shows the land degradation severity class). Taking in to consideration the percentage of yield decline and the efforts required to reverse it, the twenty classes are again sub grouped in to four major severity classes. The four degradation severities measures are: light, moderate, severe, and very severe. “A very sever degraded area can mean, for example, either extreme degradation affecting 10-25% of a mapping unit, or a moderate degradation affecting 50-100% of the unit” (Bot A.J. et al.2000).

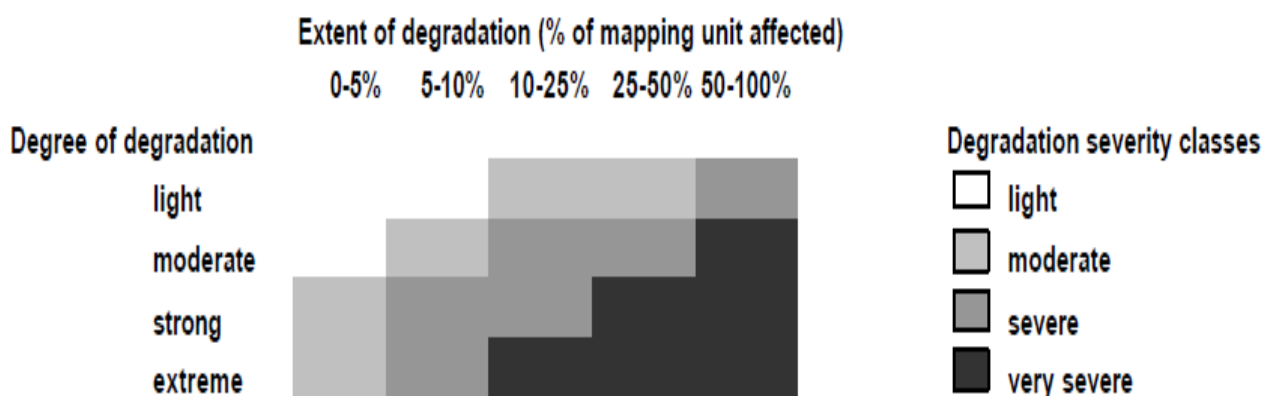

Figure 24: Land degradation severity classes

Source: Bot A.J. et al. (2000)

The various stages of soil degradation severity and their productivities have been studied (Denboba, M. A. 2005). A persistent productivity loss of 10-15 percent is rated as 'slight' degradation. A 15 percent loss of productivity has been identified as a threshold limit to require major rehabilitation efforts. A productivity loss of 10-33 percent degradation is rated as 'moderate'. In this case, ameliorative measures are necessary to restore productivity. Generally, productivity losses greater than 33 percent could be rated as a 'sever' and 'very sever' degradation. Rehabilitation of severely degraded land could be reversible, but only at high cost and by the use of expensive technologies. However, rehabilitation of very severely degraded land is highly irreversible.

The productivity loss of the various degradation severity classes presented by Denboba, M. A. (2005) didn't clearly distinguish differences between two successive degradation classes. Moreover, the estimates in productivity losses lack explicit parameters which measure the productivity losses resulting from degradation.

In this paper we will use land suitability class for the investigation of land use dynamics and decline in land fertility rather than the degree of degradation and severity of degradation. Kassam, A. H. et al. (1991) has grouped the degradation productivity losses into four class suitability. The classification is based on the effect of soil depth on productivity. The estimate of the effect of soil depth indicates that there is no significant loss of production until the soil becomes sufficiently so shallow that the shortage of moisture becomes a limiting factor for productivity. In other words, the assumption is top soil removal reduces soil depth, which, in turn, reduces the water holding capacity of the soil subsequently reduce crop yield by increasing crop water stress (Kassam, A. H. et al. 1991, Sutcliffe, J. P. 1993). The land suitability classes are as follows:

- Suitable (S): soil water becomes limiting and there is at least 20 percent decrease in yield potential.
- Moderately suitable (MS): soil water becomes limiting and there is at least 40 percent decrease in yield potential.
- Marginal suitable (ms): soil water becomes limiting and there is at least 60 percent decrease in yield potential.
- Not-suitable (Ns): soil water becomes limiting and there is at least 80 percent decrease in yield potential (Kassam, A. H. et al. 1991).

If erosion takes place uniformly on soils of varying depth, with a net loss rate, it results in the transformation of marginal land into non-suitable land in the degradation of others land, suitable and moderately suitable, towards moderately suitable and marginal suitable respectively in the long run. The depth of top soil at which the yield would start to be negatively affected by soil depth is called *critical maximum depth*. The critical maximum depth depends on the type of crop and climate of production. Once the critical maximum depth has been achieved, the productivity loss is linearly related to the depth of top soil until the soil becomes too shallow to produce any crop at all (Kassam, A. H. et al. 1991, Sutcliffe, J. P. 1993). The depth of top soil at which crop production is abandoned, is called *critical minimum depth*. If the yield potential decreases by 20 percent of the crop yield that would be obtained at the maximum critical depth, then the land is considered to be useless or unproductive (ARS 2002, B-GRS, 2003, Kassam, A. H. et al. 1991).

In Ethiopia estimated critical maximum and minimum top soil depth for cereal mainly maize, wheat, sorghum, and tef are inconsistent. Sutcliffe (1993) presented the critical maximum and minimum depths of the cereals on red soil as:

	Maize/wheat	Sorghum	Tef
Critical Maximum Depth (cm)	95	80	85
Critical Minimum Depth (cm)	45	35	30

In last decade, ARS (2002) and B-GRS (2003) estimated the critical maximum and minimum depths of cereals to be:

	Maize/wheat	Sorghum	Tef
Critical Maximum Depth (cm)	93	77	91
Critical Minimum Depth (cm)	28	22	10

The stock and flow structure of the dynamics associated with the physical loss of top soil is presented in the figure 8 below. We have identified five stocks within the stock of fertile cultivated land that are associated with the degradation stages, namely very suitable land, suitable land, moderately suitable land, marginal suitable land, and non-suitable land. Moreover, four fallow-land stocks of each degradation stages are identified. In the model, each of the main stocks (degradation stages) has specific productivities expressed in terms of the maximum potential yield that relative to high productive land. The land coming from the potential arable land is called *high productive land* and is assumed to have the maximum potential yield. The suitable land corresponds to 80 percent of the potential yield, moderately suitable land correspond to 60 percent of potential yield, 40 percent of potential yield

marginally suitable and not-suitable land corresponds to land, 80 percent of the potential yield corresponds to.

A linear relation is assumed to exist between the top soil depth (when less than the critical maximum depth) and the potential yield. Each of the degradation stages has local maximum and local minimum top soil depth. By considering the average net topsoil loss rate for Ethiopia, we are able to find the average life time of the land that could residing in each of the degradation stages. The average life time is then used for define each of the flows as a first order adjustment.

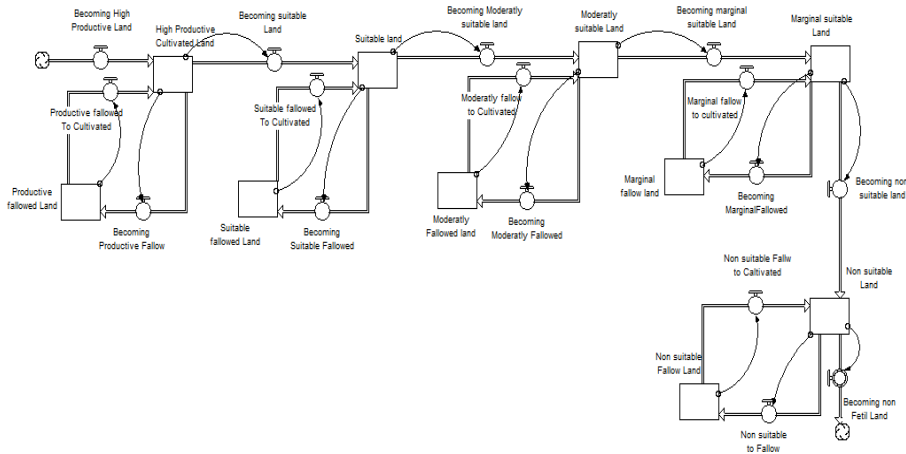

Figure 25: the stock and flow structure of the degradation dynamics within the stock of cultivated land

We used the average fallowing fraction and the effect of rain fall on the cultivation area to define the conversion of cultivated land into fallow land for each stage and an average time to remain fallow is used to define the reverse process.

Bot A.J. et al. (2000) has presented the data of the various land degradation severity classes of Ethiopia for the year 1994 as non-degraded 53000 km² (4%), light 125000 km² (10%), moderate 700000 km² (57%), sever and very sever 97000 km² (8%), and 244000 km² (20%), respectively. But these values are problematic as their sum is higher than the total area of the country presented in his report (1104000 km²). Bot, A. J. et al. (2000) also indicated the very sever land resulting from agricultural practice is 64 km² (6400 ha). Sonneved B.G.J.S. (2002) has analyzed the rural population distribution over the degraded areas. He presented the percentage composition of low degraded area 33.7 percent, slight degraded area 36.6 percent, and moderately degraded area 17.2 percent, sever and very sever degraded area 6.5 and 6 percent respectively.

According to the definition of Central Statistic Agency (CSA), fallow land is defined as “land which has been or is intended to rest for at least one agricultural year (season) and a maximum idleness of less than five years”

3.2.2 .2.2.Land Fertility Dynamics

The dynamics of soil fertility is based on the dynamics of land degradation stages i.e. as the land moves from the stock of high productive to the stock of non-suitable land, in each successive stage, its potential yield decreases by 20% (section 3.2.2.1). We consider the potential yield at the maximum critical depth (or a depth higher than the maximum critical depth) to be the inherent potential yield because it is the innate yield of the land without the application of any technologies (fertilizer, improved seed, pesticides...). We use a weighted sum of the inherent potential yield of each land type to calculate the cumulative inherent potential yield of the total cultivation land.

Depending on the use of agricultural inputs, we classify the yield types obtained from the inherent potential yield as; *improved seed and fertilizer applied yield*, *traditional yield only fertilizer applied*, and *traditional yield without fertilizer and improved seed i.e.* sequentially, use of both improved seed and fertilizer, only fertilizer used, and neither fertilizer nor improved seed used. The detail description of the current yield model is found in section (3.3.2.6).

3.2 2.3 Market

So far we have seen the population dynamics, Land use and fertility dynamics in section 3.2.2.1 and 3.2.2.2 respectively. From the two sectors we opt to see the potential food consumption demand and the potential food production supply (cereals) from private farmers at a national level. The interaction of supply and demand in general meets at the market (whether it is a physical market or not). Here, our main concern is to deal with the market parameters together with their implication in insuring food security. The concept of cereal market is much more complex than computing the supply and demand of cereals for the population. And in this section we thoroughly analyze the one and half decade interaction of the main variables involved in the market such as: cereal supplies, consumption demands, imports, shipments, calorie consumption, expenditure and purchasing power, losses, producer & consumer price of cereals, inflation rate, etc. In general, we try to investigate the main structures which directly or indirectly influence undernourishment of the population at a national level.

3.2.2.3.1 Food Consumption Need

We use two different terminologies to express food consumption needs of the population: namely, desired cereal consumption and desired effective cereal consumption. We refer desired food consumption as the need of cereal foods based on the minimum daily energy requirement of the individual. While, when the desired cereal consumption is materialized with the purchasing power of the person, we call it as desired effective cereal consumption. Thus, the basic parameter used in determining desired cereal consumption and desired effective cereal consumption is based on calorie need of individuals. From the literature reviewed in section 1.2, in Ethiopia the urban population constitutes 15% of the total population which is the purchaser of food produced by 85% of the remaining population. And one of the constraints of the market in setting price at a higher level, besides to relative low demand, has been the low purchasing power of the urban population (Demeke, M., 2003).

A reasonable analysis of the consumption for cereal in a such market should account for the difference between desired cereal consumption (most natural one, based on the minimum daily calorie requirement of the individuals) and the effective cereal consumption (the consumption based on the potential to own the food, usually associated with the purchasing power of the individual). It is the latter rather than the former that influence in the

market system mechanisms such as price setting, shipment, inventory handling, and, most importantly, it is the satisfaction of effective consumption that feeds the population. A simple implication of the comparisons of the two cereal consumptions at this stage is, when the effective cereal consumption is less than the desired cereal consumption, an undernourishment is expected or else if the two are equal then we do not expect the existence of undernourishment provided that there is sufficient cereal in the market (physical access) for the money spend to buy cereals.

3.3.2.3.1.1 Desired Cereal Consumption

Desired food consumption is based on the food requirement of the individual(s) that support healthy and good nutrition for maintaining a well-nourished and a healthy population at large. Although there exist wide variety concepts of nutrition, our focus lays on the calorie (energy) content of the food. Human energy requirements are estimated from measures of energy expenditure plus additional energy needs for growth, pregnancy, and lactation. Recommendation of dietary energy intake from food must satisfy these requirements for attainment and maintenance of optimal health (FAO/WHO/UNU, 2001).

According to the definition of FAO/WHO/UNU (2001) “Energy requirement is the amount of food energy needed to balance energy expenditure in order to maintain body size, body composition, and a level of necessary and desirable physical activity consistent with long term health”. Estimated energy requirement are highly sensitive to an individual’s specific characteristics such as: gender, age, body size, presumed body composition, living environment and physical activity. However, the average energy requirements could be set for groups or classes of individuals who have similar characteristics. The level of energy intake recommended is based on estimates of the requirements of a healthy, well-nourished individual. Energy requirements and recommended level of intake are often referred to as daily requirements.

3.3.2.3.1.2 Per-Capita versus Adult-Equivalent Estimates of Calorie Consumption

Due to the complexity in considering every characteristic of individuals in determining food consumption at national or household level, it has been common to use average per-capita food or calorie in research, and in the computation of the food balance sheet for countries. FAO special report of Ethiopia (2009) has used the average per-capita consumption of cereals and pulses for the computation of food balance sheet of Ethiopia. Similarly, DRMFSS (Disaster Risk Management and Food Security Sector, 2011) of Ethiopia most often uses a desired average per-capita calorie requirement of 2100 Kcal per person per day in their rations in the food insecure areas.

Despite the fact that the use of average per-capita food consumption/requirement simplifies the computation of food consumption/requirement demands at a national level, it does not account the demographic changes in the population either in terms of age or sex groups. As a result, such calculations possibly cause us for under estimate the food demand of the population when a large share of the population is composed of youngsters.

The adult-equivalent calorie requirement is based on mean calorie requirement of a reference adult man. Conversion factors are defined as a ratio between the calorie requirement for each age group, gender, and that of the reference adult. Hence, using the conversion factors (ratios), the calorie requirement of various age groups and sex are computed. The adult-equivalent calorie requirement level is therefore higher than the per capita level. The adult-equivalent scale is useful tool for narrowing the difference between demand estimates found from the use of average per-capita consumption demands and real consumption demands. It also allows for identifying the contribution of various family members to the overall household food consumption pattern unlike per-capita measurements (Claro, R.M et al, 2010). In our analysis of desired consumption demand at national level, we preferred to use adult-equivalent daily calorie requirements instead of per-capita daily calorie requirement. The conversion factor for adult equivalent calorie for the various age groups is given as follows.

Conversion to ‘‘Adult-Equivalent’’ for calorie analysis

Age Group (Years)	Male	Female
<1	0.30	0.30
1-2	0.46	0.46
2-3	0.54	0.54
3-5	0.62	0.62
5-7	0.74	0.70
7-10	0.84	0.72
10-12	0.88	0.78
12-14	0.96	0.84
14-16	1.06	0.86
16-18	1.14	0.86
18-30	1.04	0.80
30-60	1.00	0.82
>60	0.84	0.74

Table 2: Adult-equivalent calorie conversion factor

Source: CSA- HCE survey (2010/11).

From the population sector we identified four stocks of population depending of their age as: Children age 0-4, School age population age 5-14, Fertile age population age 15-29, Adult population age 30 plus. These population stocks consists of both genders in similar age groups whose desired calorie requirements is similar. However, in each stock the calorie consumption of the two genders are computed separately, depending on their proportion in the total stock. Moreover, the average age in each stock is used to determine the adult-equivalent proportion. Figure 26 shows the model structure used for the computation of cumulative adult-equivalent fraction of the entire population.

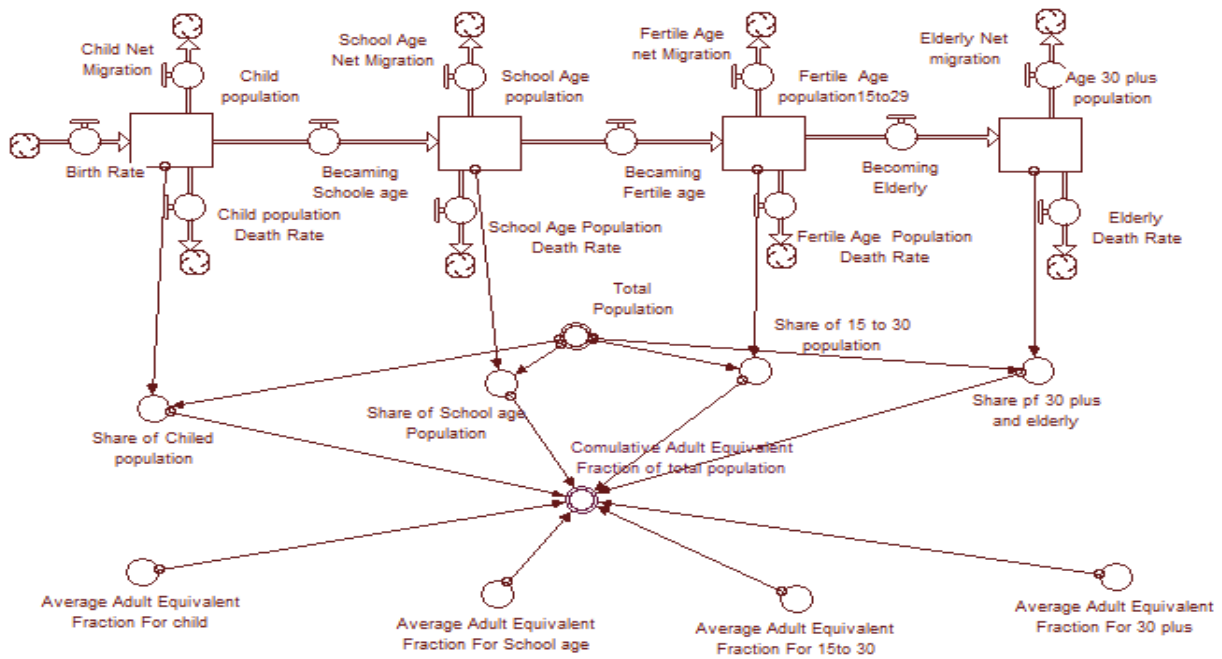

Figure 26: Model structure showing the relationship of the population age cohorts and cumulative adult-equivalent fraction.

After assigning the average adult-equivalent fraction of each age cohort in the model, we work out the share of the cohorts from the total population. The cumulative adult-equivalent calorie fraction of the entire population is computed as a weighted sum of the respective desired daily adult-equivalent calorie fractions of each cohort in the aging chain. Thus, we can say that, the *cumulative adult-equivalent calorie fraction* is the representative (average) adult-equivalent calorie fraction of the whole population (equivalent to the per-capita adult-equivalent fraction).

Multiplying the cumulative adult-equivalent calorie fraction with the daily adult-equivalent Kcal consumption of a person (the minimum daily Kcal requirement for an Ethiopian adult) results in the current national cumulative daily desired adult-equivalent calorie consumption of an average person. Therefore, the national cumulative desired daily adult-equivalent energy of an average person is considered as the average per-capita consumption of the population. Moreover, this value is not fixed over the entire simulation time; rather the model adjusts the value depending on the share of the cohorts that from the total population as individuals transfer through the age cohort.

By modeling the calorie requirement in this way we may be able to examine future changes in the calorie demand/requirement that comes with demographic changes in the long run. Notice in this model, we did not consider special calorie demands for pregnant and lactating women.

Since we are analyzing the desired calorie consumption on yearly bases we changed daily desired calorie consumption in to annual desired cereal consumption. A simple multiplication of daily desired calorie consumption with the number of days in a year (365) provides the required result.

So far, in our model, we are able to compute the annual desired calorie consumption of average person in the population. But our next main intention is to examine the annual desired *cereal calorie* (calorie obtained from cereals) consumption of average person. To do this we need to see the per-capita cereal calorie consumptions under normal circumstances.

3.3.2.3 .1.3 Calorie Consumption Trends and Desired Calorie Share of Cereals

The household income, consumption and expenditure (HIEC) survey (latter called household consumption and expenditure survey, HEC) results has shown the cereal consumption constitute a large share of the population’s dietary calorie consumption. In the 1995 survey, at country level, the daily per-capita calorie intake was 1938.6 Kcal. From this calorie consumption, cereals account for 67.3 %. There is a slight variation on the amount of total calorie consumption and its cereal share between urban and rural population. For example, the rural and urban per-capita daily calorie intake reported is 1941.7 and 1921.7 while the cereal calorie share is 69.7 and 58 % respectively. In the four HEC surveys (1995, 1999/00, 2004/5 and 2010/11) under consideration, there is also a slight variation in the share of cereals in the various regions of the country. These variations may arise from environmental and geographical differences in the area in which people live and/or the cultural differences among these populations. However, in our analysis the average of all regions at a country level has been applied.

Daily Per-Capita Cereal Calorie Share			
Year	Rural	Urban	Country
1995/6	69.5	58	67.3
1999/00	63.9	56.2	64.9
2004/5	63.2	52	61.8
2010/11	59.7	48.2	57.9

Table 3: Daily calorie share of cereals from the daily calorie consumption of food

Source: Author computation from HCE surveys

From the table above, it can be noticed that the per-capita cereal calorie share has been continuously decreasing starting from 67.3 percent in 1995 to 57.9 percent in 2010. There could be various explanations for the decreasing trend though part of the explanation is beyond the boundary of this study.

The 2010 daily per-capita share of cereals is computed directly from the daily Adult-equivalent calorie consumption share of cereals (HCE survey 2010). In this survey it has been reported that the daily adult-equivalent gross⁴ calorie intake was 3004.6 Kcal at the country level.

Our basic supposition in computing the desired cereal consumption is that cereal shares are the same in the desired and actual consumption i.e. we assume that the share of cereals in the actual daily consumption of food is the same as the share of cereals in the desired consumption of food. But it should be noted that this doesn't mean the amount of cereals is the same in the desired and actual consumption of food. Therefore, the calorie share of cereals has been applied, in determining the desired calorie from cereals meaning, to split the desired annual adult-equivalent calorie consumption into desired annual adult-equivalent calorie obtained from cereals and non-cereals. Hence, the annual desired adult-equivalent calorie obtained from cereals is a simple multiplication of the annual desired adult-equivalent calorie by the share of cereals in the annual calorie consumption.

The next step in the model is to describe the annual desired Kcal of particular cereals for the average man (adult-equivalent). To do this, we first need to know two important determinants, - the amount of annual average per-capita consumption of cereals and the calorie content of each cereal. From these we compute the total Kcal found from cereals and their shares from the total.

In Ethiopia, there are eight most widely reported and produced cereals: tef, wheat, maize, barely, rice, sorghum, millet, and oats, our analysis is based on these cereals in daily or annual consumption. We have applied annual amount of cereal consumption data, from the 1995 household income, expenditure, and consumption survey (CSA 2010/11). In addition, *the food composition table* prepared jointly by the Ethiopian Health and Nutrition

*Gross Calorie*⁴: The total number of kilocalories in a given weight of food product, prior to discarding any inedible materials (CSA-HECS, 2010)

Research Institution (ENHRI, 1995-1997) and FAO (Food and Agricultural Organization of the United Nations) is used to identify the calorie of each cereal under consideration per 100 gram of edible portion. In the food composition table the various Ethiopian food types and their corresponding calories per 100 grams of edible portion are presented.

In our analysis, and for the purpose of further analysis, we refer to edible cereals which are most close to the cereals obtained from normal market (less processed cereals) or directly obtained from production e.g. the whole grains or flours of wheat, maize etc. Some of the cereal types and their corresponding calorie per 100 gram are given in the table below.

Cereal Product Type	Kcal per 100g edible portion
Barley black flour	370.9
Barley black whole grain	370.8
Barley white grain	372.3
Barely White flour	368
Maize yellow flour	376
Maize whole grain	375.1
Maize fresh	235.6
Maize White flour	378.2
Maize whole grain	375
Emmer wheat flour	379.7
Emmer wheat raw	361.6
Millet black flour	350.4
Millet black whole grain	350.5
Rice whole grain	357.2
Sorghum red flour	377.4
Sorghum red whole grain	380.5
Sorghum white whole grain	359.2
Tef red flour	355.1
Tef white flour	358.5
Tef mixed flour	353.8
wheat black flour	353.8
wheat black split grain	362.4
wheat black whole grain	357.1
wheat white flour	362.9
wheat white split grain	365
wheat white whole grain	362.3
wheat mixed whole flour	355.1
wheat mixed whole grain	357.4

Table 4: Cereals and their Kcal per 100 gram of edible portion

Source: Food composition table, EHNI and FAO (1995-1997, & 1968-1997) for use in Ethiopia part III and IV.

The average amount of cereals consumed per capita may vary from year to year depending on the supply of food and its relative price on the market. Despite this fact, we use the 1995 HIEC survey data as a starting pivot for the calibration of the model.

After the computation of the total calories consumed from cereals, the cereal shares have been found i.e. the desired amount of Kcal required from each cereal is computed from the consumption share of cereals and the annual calorie consumption of cereals. Now the next step is to convert the amount of daily desired Kcal (energy) of each cereal into the amount (weight) of corresponding annual desired grams of cereals. A simple division of the daily desired Kcal of the cereal type into the average Kcal of the same cereal type per 100 gram results the daily desired 100 gram of each cereal type.

In the Ethiopian cereal market, the most common cereal food bought directly from market is not in edible forms (it is unprocessed). Commonly, we refer to cereals from market as whole grains that come directly from production. For further analysis, we must also consider the amount of cereal food lost in the food processing. We could not find research conducted in this area, and the amount of food lost in the food processing stages, especially in the Ethiopian food processing system is not known. We apply industrial extraction rates as an estimate of the cereals losses bought from market till they are edible. FAO (2001) food balance sheet has indicated that the extraction rates of some of the cereals as fallow in the table.

Name of cereal	Extraction rate(%)
Wheat	75
Rice paddy	67
Barely	55
Barely malt	80

Table 5: Industrial extraction rate of some cereal

Source: Food Balance sheet (FAO, 2001)

The annual desired gram of cereal obtained is only in edible form. Thus a person would need to buy an amount of cereal that is larger amount than the person intends to eat. In short, the extraction fraction should be taken into consideration to arrive at the annual desired amount of cereal produced. For example, if the extraction rate of Maize is 80%, and the desired edible consumption of maize is 100 gram then, the amount of maize bought from market should be 125 gram i.e. 25 gram of maize is lost in food processing. Knowing the desired gram of cereal whole grain which should be bought from market, we use unit conversion to kilo gram, and quintals (100 kilo gram) to express it more effectively.

The model structure for computing the annual desired cereal consumption, discussed so far, is given below.

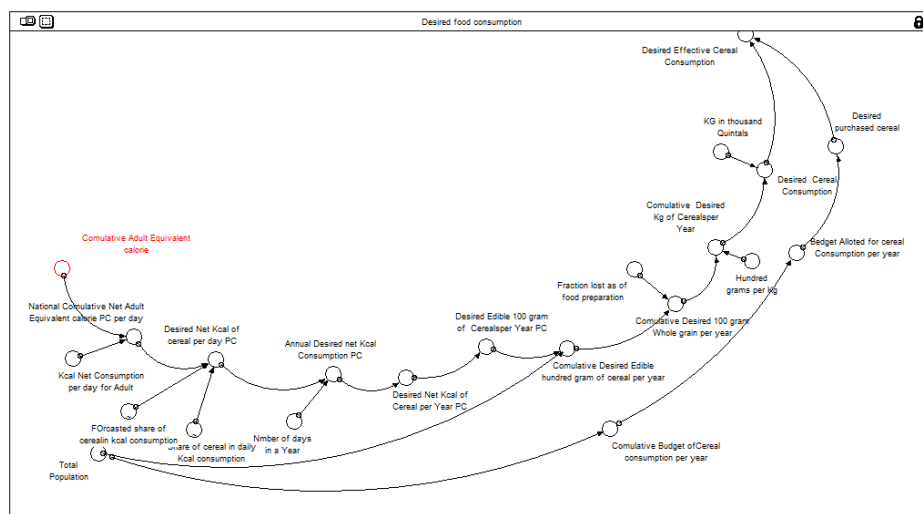

Figure 27: Model structure representing the computation of annual desire cereal consumption

This way, the desired cereal consumption of an average man per annum may be found. A simple additional multiplication with the total population results in the annual desired cereal consumption demand of the population.

3.3.2.3.2 Desired Effective Cereal Consumption

In this section we try to examine the desired effective cereal consumption from the economic point of view, particularly on the purchasing power of the budget allotted for cereal (money) of the population. As a result, it is important to discuss the household and per-capita expenditure and consumption patterns of the population.

3.3.2.3.2.1 Review of Household, or Per-capita Income, Consumption, and Expenditure Surveys

Central Statistical Agency of Ethiopia has conducted four surveys (HICE, or HCE) for the last fifteen years on average five years interval. In the first two surveys (HICE, 1995 and HICE 1999/00), income, expenditure, and consumption have been reported. However, the last two surveys didn't include income.

In country surveys of these types, it is common to see the reports of main variables presented in groups or classes like, income and expenditure groups. In the first two surveys the income and expenditure groups are reported in the groups with a nominal currency (birr) of, < 600, 600-999, 1000-1399, 1400-1999, 2000-2599, 2600-3399, 3400-4199, 4200-5399, 5400-6599, 6600-8999, 9000-12599, 12600-16599, 16600-19999, and 20000 >. It should be noticed that these intervals do not have regular length and most importantly, an individual or household who is in one of the income group doesn't necessarily belong in the same expenditure group.

As mentioned in the reports and observed from the data of the surveys, income statistics reported by households usually tends to underestimate the actual income level due to various reasons. As a result of such reports, it has been common to use expenditures as a proxy of income by many countries (CSA-HIES 1995, CSA-HIES 1999/00). However, there are considerable proportions of households or individuals either whose expenditure is higher than their income or whose income is much higher than their expenditure. Figure 28 shows the per-capita income and expenditure distribution with their respective groups.

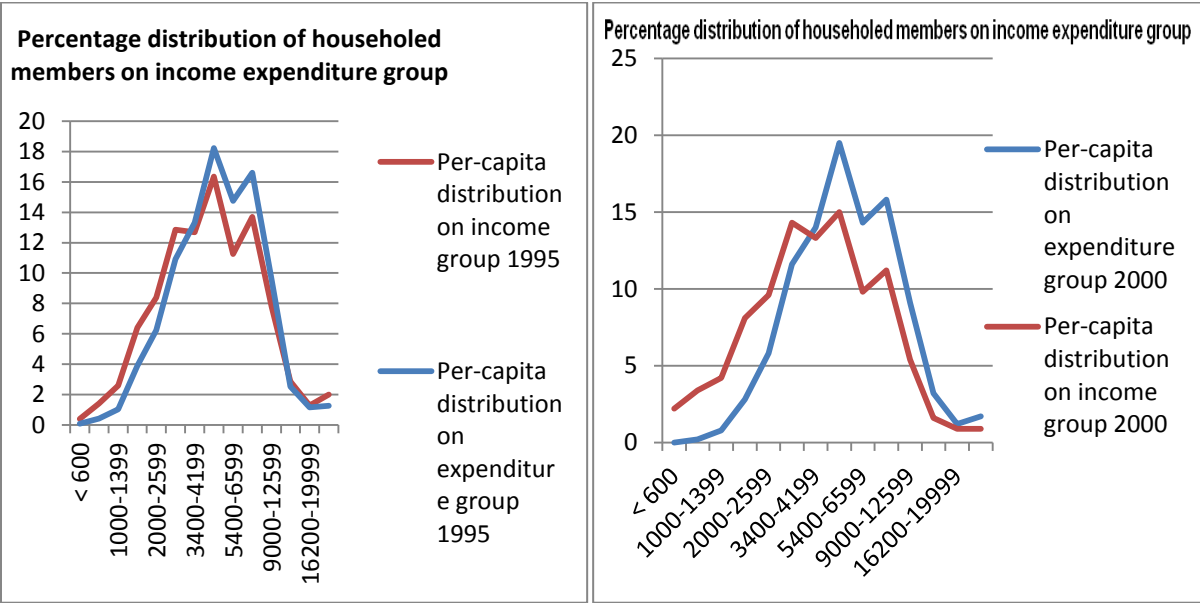

Figure 28: The per-capita income (red curve) and expenditure (blue curve) distribution on income and expenditure group, 1995 and 1999/00 respectively.

Source: Author computation from the 1995 and 1999/00 HIEC surveys

At household level, 46.1 percent of the households in the country spend more than their earnings. Whereas, 33.7 percent spend their earnings, 20.1 percent of the households

spend less of their earning. In this survey (1995) the average household size was 5. Similarly, the 1999/00 HICE survey, It has been reported that 70 percent of the households spend more than their earning. Whereas, 20.6 percent spend their earning, 9.3 percent spend less than their earning.

3.3.2.3.2.1 HIEC (1995, 1999/00) Survey Food Expenditure

The household or per-capita food expenditure constitutes the larger share of the income at country level. There is slight difference in the food expenditure of urban and rural households. For example, in the 1995 survey, rural household spend 54.2 percent of their income for food while urban households spend 47.1 percent of their income for food. The average, country level, 52.7 percent of household’s income is used for the utilization of food. Likewise, 52.3 percent of the household income has been used for food utilization in the (HICE, 1999/00). Most importantly, from the food share of income, cereals are the main constitute. Around 50 percent of the food expenditure is allotted for cereals.

One of the common patterns observed in the first two surveys is the percentage of income spends on food/cereals decrease as the income of the person increases in each income/expenditure group. Figure 29 shows the share of food and cereal of the total Expenditure.

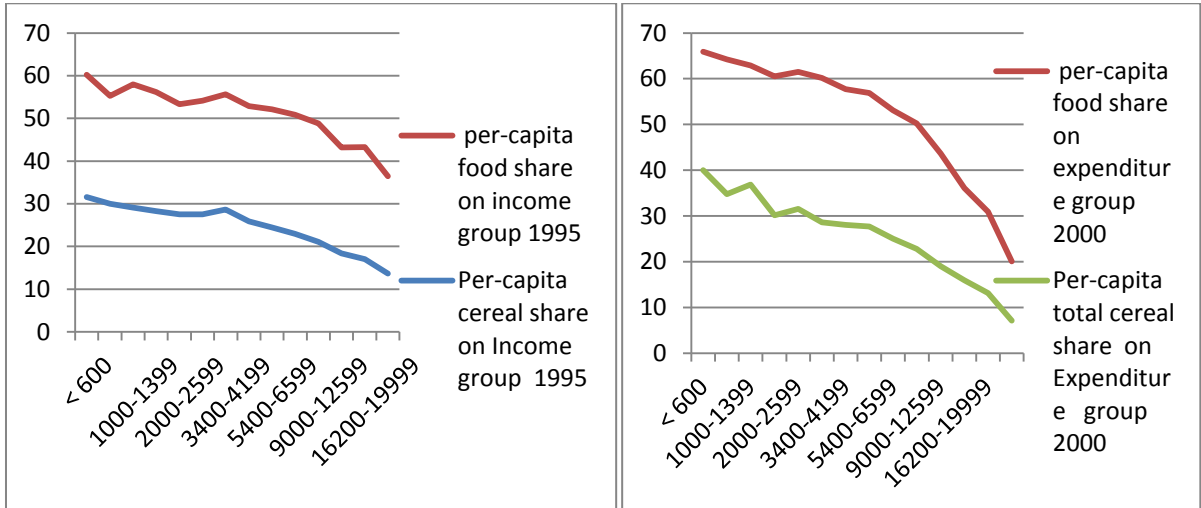

Figure 29: Comparison of per-capita food share (red curve) and cereal share (blue/grey curve) of 1995 and 1999/00.

Source: Author computation from 1995 and 1999/00 HICE surveys

3.3.2.3.2.2 HICE (2004/5), and HCE (2010/11) Surveys

The last two surveys have similar manifestation; both are less detail in presentation and exclude the income distribution. Besides, the main variables (expenditure and consumption) are organized in to five groups called Quintiles. The household expenditure quintiles are used to desegregate households by their expenditure level. These quintiles are grouped by first ordering all households in ascending order by value of household expenditure and dividing them in to five equal parts such that each group has a share of 20 percent. The first quintile (Q1) includes the 20 percent of households with the lowest annual expenditure and the last quintile (Q5) includes the 20 percent of households with the highest annual expenditure.

Similar to the first two surveys, in the last two surveys, expenditure for food represents a large share. Moreover, the trend of expenditure share for food/ cereal decreases as the quintiles move from Q1 to Q5 i.e. households spend less fraction of their expenditure for food or cereal in the higher quintile than in the lower quintiles. Figure 30 shows the expenditure share for cereal for the last two surveys.

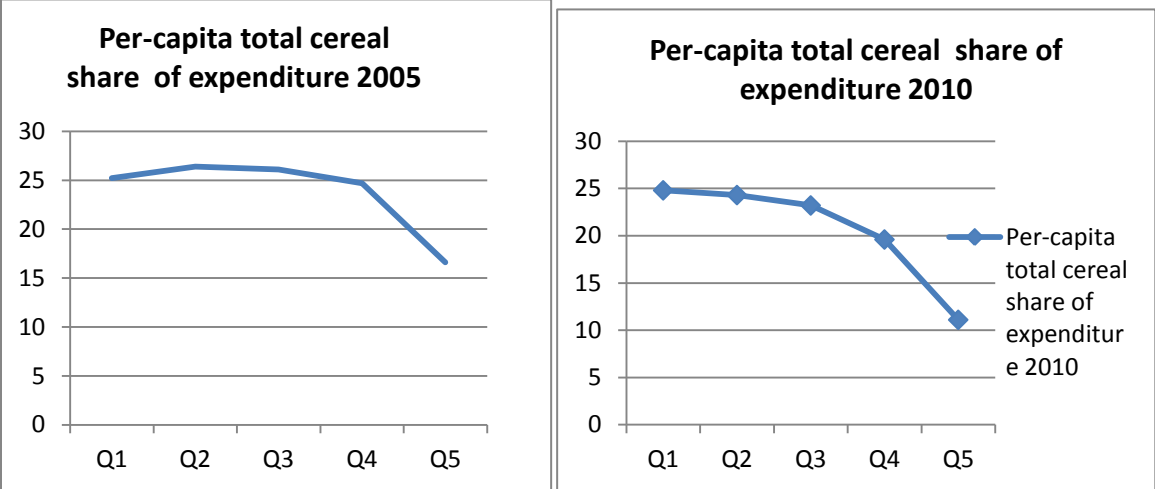
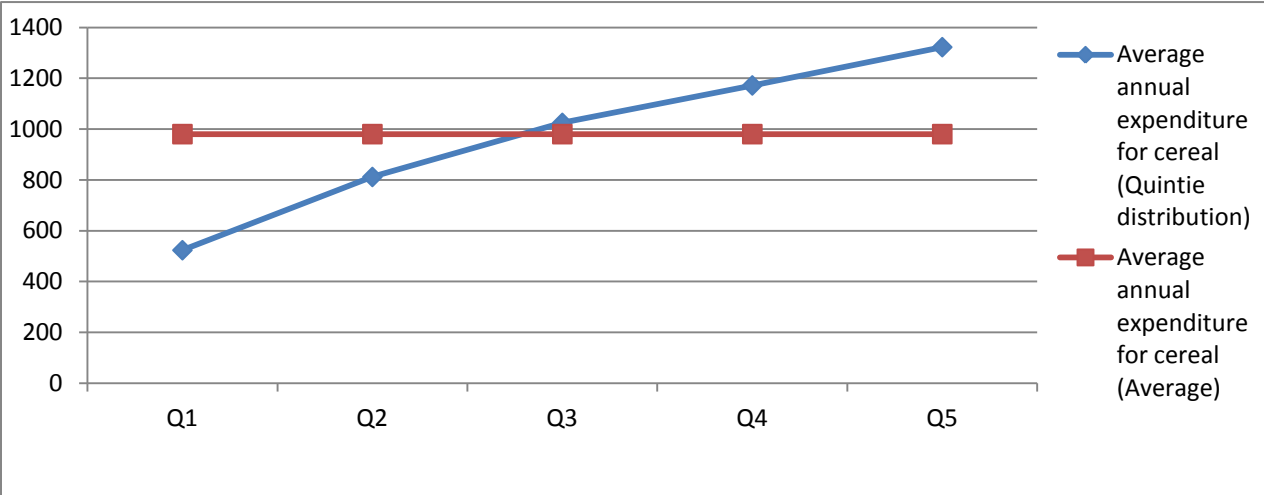

Figure 30: Per-capita total calorie share of cereals in 2004/5 and 2010/11

Source: Author computation from 2004/5 and 2010/11 HCE surveys

The most important parameters in our model analysis (in this section) are the amount of expenditure (nominal expenditure) and the cereal share of the expenditure. Our intention is to examine the purchasing power of the population, especially cereal purchasing power, in securing annual calorie needs.

The basic assumption considered herein, average expenditure is the same (with little deviation) across the expenditure groups' .i.e. whether individuals are in the lower or higher expenditure/income group their expenditure for cereals is on average same (with a slight deviation). To this agreement, evidence shown in the summary of the HCE surveys, households in the lower income/expenditure group spend money which is more than their earnings to satisfy their food needs besides having relatively larger share of expenditure for cereal. On the other hand households or individuals who are in the highest expenditure/income group, their expenditure share for cereal is much more less than the expenditure share of households/individuals in the lower expenditure/income group. Hence, in both of the two cases the per-capita cereal expenditure converges to the average per-capita expenditure. A comparison of per-capita-cereal budget computed from (a), annual average per-capita expenditure and annual average cereal share, (b) average per-capita annual expenditure of each quintiles and the annual cereal share in each quintile is given below of the year 2010.



Source: Author computation from HCE (2010/11) survey

Figure 31: Comparison of average annual per-capita cereal budget obtained from the use of average per-capita expenditure and the use of average per-capita expenditure distribution over quintiles.

To sum up this section, we use average annual per-capita expenditure and cereal expenditure share in the model to compute annual average per-capita budget for cereal. The time series table of annual average per-capita expenditure and weighted average cereal expenditure share used in the model are shown below.

year	Average per-capita expenditure
1995/6	1319.08
1999/00	1411.80
2004/5	1697.35
2010/11	4759.77

year	Weighted Average cereal expenditure share
1995/6	0.19
1999/00	0.24
2004/5	0.21
2010/11	0.18

Table 6: Time series table of average per-capita expenditure and weighted average cereal expenditure share

Source: Author computation from HICE and HCE survey

Thus the total annual budget of cereal is a result of multiplication of annual per-capita cereal budget with the total population. Here we use the total population because in the HICE surveys the annual per-capita expenditure represents the average expenditure of every individual including the one consuming their cereal production (Average per-capita expenditure includes own production consumption). From the total annual cereal budget we also need to know the shares of each cereal. We took data from the 1995 HICE survey the amount of cereal consumption (kg of consumption of each cereal) and producer price (from World Bank) to estimate the whole cereal expenditure and the share of each separately. But it is difficult to expect this cereal expenditure share has been maintained for the last fifteen years since the amount of production and the price of each cereal has been changing. And it is very common that most of the cereals are substitutes of each other in the daily cultural foods of Ethiopia. For example for preparation of the local food called “injera” tef is very common in urban areas and, maize, and barely are common in rural areas, but in the scarcity of the common once, others like maize, wheat, sorghum, rice or a mixture of them has been used in both urban and rural areas. On the other hand, in the season of abundance production of some cereals, it is most likely, people consume more of the abundantly produced cereals especially the producing farmers and also consumers since the price generally goes down. In the analysis of expenditure share of cereals, the initial expenditure shares (1995) together with the relative production of each cereal from the total production are used as an adjustment to the model. Hence, multiplication of the total annual budget by the expenditure shares of each cereal results the total annual budget of each cereal. Finally, the annual effective cereal demand becomes the division of the total annual cereal budget by the corresponding price of cereals in the given market (producer or consumer price).

$$\text{Annual_Effective_Cereal_Demand_in_Quin}[\text{cereal}] = \frac{\text{Bdget_Alloted_for_cereal_Consumption_per_year}[\text{Cereal}]}{\text{Consumer_Price_per_thousand_Quintal}[\text{Cereal}]}$$

3.3.2.4 Cereal Inventory, Supplies and Shipments

For further analysis, especially for cereal price analysis, it is demanding to deal with the accumulation of cereals in a stock called cereal inventory. Considering the accumulation of cereals in a stock at national level could seem unrealistic unless we re-define the implication of the stock. Therefore, we defined the inventory of cereal to represent; the accumulation of cereals in the retailers’ or wholesalers’ shop, Grain trade enterprise, storage areas of private farmer producers’ etc. Generally the inventory represents any accumulation of cereals either for direct consumption (by producers) or for sale for human consumption purpose (retailers and wholesalers).

Thus the amount of cereals in the inventory is altered by two main inflows namely cereal delivery and commercial farm cereal delivery, and three main outflows, namely consumption shipment, industrial shipment and post-harvest loss. For the purpose of our analysis, we chose to arrange the flows in this way. Figure 32 shows the stock and flow structure of cereal inventory and its supplies and shipments.

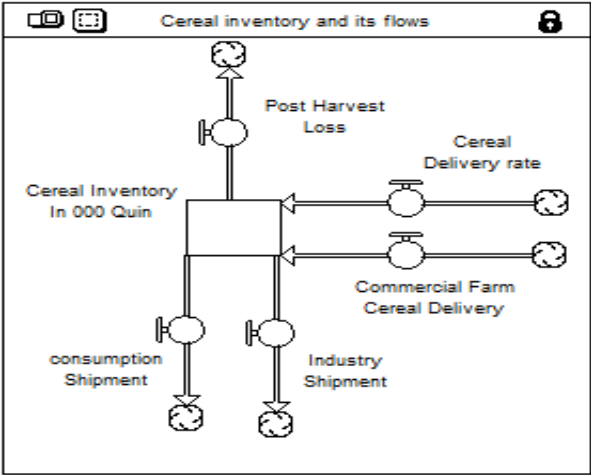

Figure 32: The stock and flow structure of cereal inventory and its supplies and shipments.

3.3.2.4.1 Delivery of Cereals

One of the two main inflows of the cereal inventory is *cereal delivery rate* which comprises three other flows named as, Meher (main rain) production delivery of cereals by private farmers, Belg (short rain) production delivery of cereals by private farmers, and net import of cereals from abroad. The second inflow to the cereal inventory is called commercial farm cereal delivery. In this section we discuss the contribution and behavior of each of these flows.

3.3.2.4.1.1 Private Holders' Meher Production Cereal Delivery

Meher production of cereals by private holders constitutes around 95 percent of the total production (CSA, 2011). It is the main domestic supply of cereals in the market. However, relatively small amount of the cereal production is delivered to the market for sale in the urban areas. CSA (2011) Crop and livestock product utilization survey reported that 66.98, 13.83, 14.66 percent of cereal production serves for household consumption, seed and sales respectively. While the remaining proportion serve as wages in kind, animal feed and others. Thus, in our model analysis apart from cereals utilization for seeds, animal feed, and wages the remaining cereal of Meher production delivers to the inventory and used either for consumption by the producers or the consumers buying the cereals from the inventory. The annual Meher cereal production is seasonal i.e. the harvesting of the production is taken place only in the months of September to February.

It should be noted that the private holders Meher cereal production delivery is the only inflow of the cereal inventory which is endogenous to the model. Hence, all other inflows of the cereal inventory are exogenous to the model and are feed by data graphically.

Thus, the cereal harvesting time or delivery time has very important in the market system. Once cereals are harvested it is stored either to the farmers' storage area or moved to the nearby market. To show the seasonal development of Meher season cereal delivery we use a graphical distribution which slowly increases starting from zero on September to its peak in December and decreases to zero on February. Figure 33 shows the seasonal distribution of Meher cereal delivery.

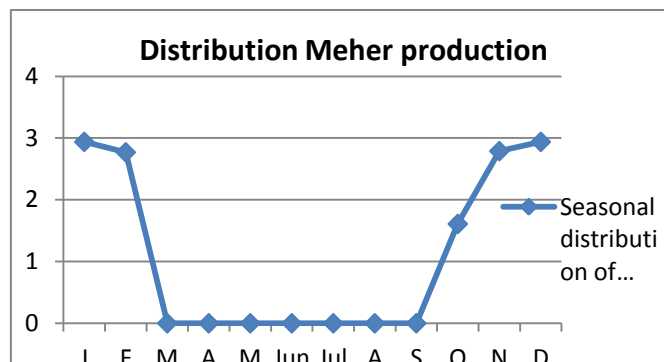

Figure 33: seasonal distribution of Meher cereal delivery.

Source: An estimate based on the definition of Meher season crop harvest and literatures

Note: In the above graph on the horizontal axis the months [J, D] corresponds the interval [0, 1] one year duration, and the integral of the curve over this interval results approximately 1 (equivalent to a cumulative distribution of normal distribution).

Hence, the subtraction the annual utilization of cereal for seed and wages etc. from the annual Meher production results the annual total production of cereals intended for consumption by producers and sale for consumers. Thus this large share of annual cereal production has to be distributed according to the months of harvest shown in the figure 33 above. The equation of distributing the annual production of Tef on months is give below.

$$\text{Meher_seasonal_Production}[\text{Tef}] =$$

$$\text{Meher_Annual_Production_for_Consumption_and_Sale}[\text{Tef}] * \text{Seasonal_Distribution_of_production}$$

3.3.2.4.1.2 Private Holders' Belg Production Cereal Delivery

The annual production of cereals produced by Belg season private holders' is estimated to be around 5 % of the total production. The main characteristic feature of Belg production or Belg delivery is its high susceptibility to rainfall variations i.e. it is highly vulnerable both to the amount of rainfall (whether it is sufficient or not) and rainfall distribution (is it coming early, on time or late). As a result, the report of cereal production has been highly irregular. Moreover in regions of Ethiopia where production is highly dependent on Belg production, food insecurity (or hunger) has been associated with the inconsistency of Belg harvest. Annual Belg cereal production data hasn't been recorded from 1995 to 2002. The annual Belg production of some cereals for some of the reported years is given below.

Annual Belg private holders' cereal production (000 Qintals=00 tons)

years	Teff production	barely production	Wheat production	Maiz production	Sorghem production	Total cereal production
2003	9.73	76.84	36.52	2009.15	418.29	2704.83
2004	221.65	474.7	n	5121.52	1957	6236.55
2005	718.78	1277.15	877.87	5750.74	266.42	9062.58
2007	325.74	1121.93	670.55	4119.69	259.68	6679.35
2008	404.33	1307.69	713.38	4003.06	375.04	6942
2009	404	1308	713	4003	375	6942
2010	908	1513	724	7598	810	11736

Table 7: Annual Belg production of some cereals of the reported years

Source: Author computation from CSA Belg production surveys.

Note: In the table above total cereal production is the sum of all cereals including others not in table and 'n' represents not reported in the survey.

In the model estimates of Belg cereal production has been made for those years where there is no surveys done. The estimate is based on the average trend of each cereal production and the average rainfall. The delivery of annual Belg cereal production should be distributed in the harvesting months from March to August so that the seasonality would be examined in the market system. To portray the seasonal delivery of cereals in the model we used a distribution shown in the graph below. In the model the graph distributes the annual Belg cereal production on the months March to August in such a way that the delivery slowly increases from zero across March and reaches its maximum in June and again slowly decreases to reach zero in August. This distribution is fixed and does not account for rainfall patterns in the given particular year.

Belg season crop is the crop that is harvested during the months of March to August

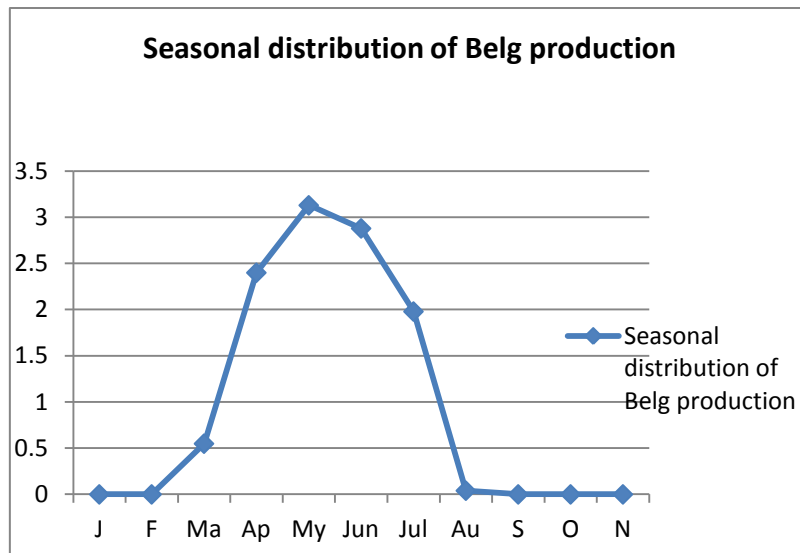

Figure 34: Seasonal distribution of Belg cereal delivery.

Source: An estimate based on the definition of Belg season crop (CSA)

Note: In the above graph on the horizontal axis the months [J, D] corresponds the interval [0, 1] one year duration, and the integral of the curve over this interval results in approximately 1 (equivalent to a cumulative distribution of normal distribution).

Thus the multiplication of annual Belg cereal production with the graphical function shown above results in the annual Belg delivery distributed from March to August.

$$Belg_season_production [Tef]=Belg_Cereal_Production[Tef]*$$

Distribution_of_Belg_season_production

3.3.2.4.1.3 Annual Net Cereal Imports and Delivery

Cereals has been also imported to Ethiopia for the last one and half decades either it is as a food aid for food insecure population or for commercial use to fill the gap created between the domestic cereal production and the national cereal food demand. Imported cereals have significant effect in the market. Especially during the last decade, it has been the part of government’s policy to regulate consumption shortfall and stabilize cereal price rise through the import of cereal from abroad. Wheat constitutes the largest share of cereal imports. In the model we used a fifteen years net import of cereals computed from FAOSTAS. Net import of some cereals is presented in the table below

Net Cereal Import (000)tone (or 0000 Quintals)

year	wheat	Rice	Maize	Sorghum
1995	514	2	25	100
1996	317	3	21	50
1997	232	4	27	10
1998	497	5	28	50
1999	596	9	35	49
2000	1227	3	28	6
2001	1066	5	19	9
2002	675	12	6	9
2003	1683	21	87	23
2004	597	18	25	3
2005	871	18	28	-10
2006	534	31	61	0
2007	605	45	34	14
2008	1118	23	73	251
2009	1854	31	57	269

Table 8: Net import of main cereals

Source: Author computation from FAOSTAT.

The historical seasonal delivery of imported cereals is not known, and it is unlikely to assume the imported cereals are delivered in the Meher delivery season. Because the Meher delivery time is the time when the highest domestic production arrives to the market and the price of cereals goes down.

Hence, in our model, we assume that the distribution of imported cereals is similar to the distribution of the Belg season production where it is delivered during the shortfall of cereals in the inventory. The graphical distribution function used for Belg delivery of cereals is also applied to the delivery of net import of cereals in the market. The multiplication of net cereal import with the graphical function results in the seasonal delivery of net import of cereal. Thus, the sum of Net cereal import delivery, Belg cereal delivery, and Meher cereal delivery comprises one of the inflows of the cereal inventory called *Cereal delivery rate*.

3.3.2.4.1.4 Commercial Holders' Cereal Delivery

For technical reasons, we represent the commercial delivery of cereals separately. Generally, commercial farms in Ethiopia are not very significant; its cereal production constitutes around 3-5 % of the total production. The main characteristic feature of commercial production is its market orientation (price).

Commercial farm production surveys have not been conducted as frequently as across private holders. As a result, production data are scarce. Only three successful consecutive surveys from CSA have been found. However, the data found in these surveys, have limited applicability in our work because the reports did not indicate the share of each cereal type in the total production. Only the total cereal production is reported. Comparison of annual commercial production, Belg cereal production and Meher cereal production and their respective shares are shown in the table below. The assumption considered in the model regarding the commercial cereal delivery is discussed in section 3.3.2.4.2.2.

Domestic production of cereals (000Quintals) and their shares by seasons and holdings

year	Commercial Cereal production (both season)	Belg Cereal production private	Meher Cereal production private	total Cereal production	Commercial cereal share (both season)	Belg cereal share	Meher cereal share
2008	3942.28	6942	144964.06	155848.34	0.0253	0.044543	0.930161
2009	6019.59	6942	155342.28	168303.87	0.0358	0.041247	0.922987
2010	6112.92	11736	177613.37	195462.29	0.0313	0.060042	0.908684

Table 9: Comparison of domestic production of cereals

Source: Author computation from CSA surveys

3.3.2.4.2 Cereal Shipments

So far we have considered the inflows of the cereal inventory. Our next step is to deal with the outflows of the cereal inventory. We identified three main outflows of the cereal inventory namely; post-harvest cereal loss, industrial Shipments, and, most importantly, shipments for consumption. In this section we will discuss each of the outflows and the basic assumptions associated with those flows, captured in the model.

3.3.2.4.2.1 Consumption Shipments

Cereal shipment for consumption in the model represents the depletion of the cereal inventory for human consumption. This shipment includes the consumption of cereals by producers (the farmers' producing the cereal), consumption of cereals by consumers (those buying cereals from market), and, possibly, cereal consumption distributed as food aids. It should be noted here that our definition of cereal inventory is broad and these shipments can take place from different sub inventories such as; farmers' cereal storage, wholesalers' or retailers' cereal inventory, cereal inventory of grain trade enterprises etc.

The important factor in determining the shipment for consumption is the annual desired effective cereal consumption computed in section 3.3.2.3.2 in the computation of annual cereal consumption, we used the annual average per-capita expenditure of every individual (both producers and consumers) and their cereal expenditure share. In the model therefore, the annual effective cereal demand is the amount of cereals (on each type) that are consumed during each year under consideration (with all referencing the amount of budget compared with the price of cereal under consideration). The annual effective demand, however, need to be examined with the existence of cereals in the inventory and the time require to adjust shipments. Because apart from the household consumption that by producers take from their own storage, the remaining cereals need to be transported to the consumers in the urban areas. An average shipment adjustment time of one week is used in the model.

Therefore, shipment of cereals for consumption is a minimum function of annual effective cereal demand and a first order adjustment of the cereal inventory with the shipment adjustment time. The model equation for consumption shipment of tef is given below. The maximum function is used to make sure the outflow is none- negative.

$$\text{Consumption_Shipment_of_cereal[Tef]} = \text{MIN}(\text{MAX}(0, \text{Cereal_Inventory_In_000_Quin[Tef]} / \text{Shipment_Adjtime}), \text{Annual_Effective_Cereal_Demand_in_Quin[Tef]})$$

3.3.2.4.2 Industrial Shipments

The second outflow from the cereal inventory is industrial shipments. A considerable amount of cereals has been used as a raw material by large and medium scale manufacturing industries. In the model industrial shipments represent the annual depletion of the cereal inventory to supply raw material for the large and medium scale manufacturing industries. The industrial products of cereals include: beer, biscuits, meten, Macaroni & pasta, flour, bread, alcohol, fafa, dube, malt etc. It could be noticed that some of the products are totally transformed to other cereals of food (alcohol) and others are processed for export or to be sold at high price in domestic market. In the computation of annual effective demand, we did not include the shares of processed foods as the prices are incomparable with the whole grains. As a result this flow (industrial shipments) is not considered part of the consumption shipment.

Cereals used as Row materials in (000)quintals

years	Wheat	Maize	Barely	Barely Malt
1995	1837.16	32.48	155.3	181.38
1996	2073.6	11.99	159.04	147.64
1997	1444.1	38.23	177520	140.62
1998	2261.05	57.98	92.02	157.08
1999	2603.08	99.65	164.12	152.41
2000	1903.28	93.95	111.33	161.03
2001	1889.65	52.94	183.95	186.09
2002	2136.07	255.46	182.11	196.41
2004	1811.27	126.5	244.18	199.45
2009	5443.67	610.58	292.3	137.76
2010	5911.7	326.55	300	171.28

Table 10: Industrial cereal shipments for large and medium scale manufacturing industries

Source: Author computation from large and medium scale manufacturing industries survey (CSA)

A comparison of annual commercial production of cereals and annual shipment of cereals for large and medium scale manufacturing industries for two years is given in the table below. Despite the fact that these flows are slightly different and difficult to compare them for longer range time series data (due to data scarcity), we assume these values are equal. So, in the model, we assume that the amount of cereal delivered by the commercial farms is shipped out from the cereal inventory for industrial manufacturing as raw material instead of being used directly for human consumption.

Delivery and shipment comparisons (000)quintals

year	Total cereal Industrial shipment	Total cereal commercial production
2009	6346.55	6019.59
2010	6538.25	6112.92

Table 11: Comparison of total industrial cereal shipments excluding barley malt for large and medium scale manufacturing industries and total cereal commercial production

Source: Author computation from large and medium scale manufacturing industries survey (CSA) and Commercial farm production surveys (CSA).

It should be noted that the assumptions made regarding the two flows has effect, but a very small, on the inventory and price. Because the share of these flows, compared to the respective total in and outflows of the cereal inventory, are very small (see the comparison made in the table 9).

3.3.2.4.3 Post-Harvest Losses

Good cereal storage areas must exist to preserve the food/cereals for longer time. Unless appropriate facilities are found for the purpose of storing and transportation, cereals losses will arise. In Ethiopia storage areas, especially storage areas of private farmers are traditional and rudimentary. A cereal warehouse typically consists of a farm level small traditional grain pit, sacks and traders warehouses that are poorly ventilated and are equipped with dirt floor (Gabriel, A.H. Proceedings of the Food Security Conference, 2003, pp. 221). As a result, post harvest losses are high. For example, depending on the type of post harvest handling losses could range between 5 and 19% for maize, between 6 and 26% for millet between 6 and 23% for wheat and between 5 and 20% for Tef (BID).

In the model, we used a smaller fraction of each cereal for the formulation of the post-harvest equation. Therefore, the post-harvest loss rate is formulated as the multiplication of each cereal loss fraction and the Meher cereal delivery rate delayed by one year. The reason we did not include other cereal delivery rates is that other deliveries arrive at times of cereal scarcities (shortfalls) and do not remain longer periods in the storage for consumption. It is the Meher cereal delivery that is the largest and remains for a longer period of time in the stock. The model structure of cereal inventory, supplies and shipments is given below.

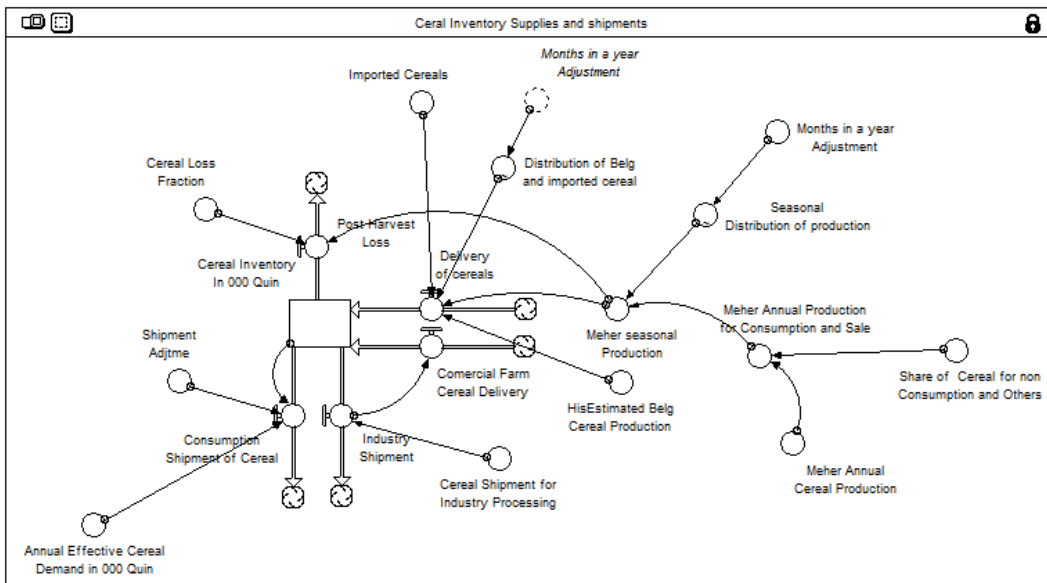

Figure 35: Model structure of cereal inventory, cereal supplies and shipments

3.3.2.5 Cereal Price

The cereal market system has been liberalized since the fall of the Derg regime in 1991. And price setting is based on an open market competition, except for minor amendments experienced in the high inflation year (2008/09). Despite its limited capacities, EGTE (Ethiopian Grain Trade enterprise) is a public enterprise which is allowed to operate in the open market in competition with the private sector for the purpose of: (a) stabilize price with an objective to encourage production and protect consumers from price shocks, (b) earn foreign exchange through export to the world market, (c) maintain a strategic food reserve for disaster responses and emergency food security operations (Rashid, S. 2010).

Moreover, the influence of the international market on the domestic market is very insignificant. Due to high transportation costs (the county is land locked), most cereals are internationally non-tradable. In other words the domestic price fall between the import and export parity price, and thus most cereals are neither importable nor exportable (Rashid, S. 2010, Dercon, S. et al 2009).

Like other market systems, the cereal market and pricing in Ethiopia involves producers and consumers. Besides a large share of cereal production is consumed by producers, domestically produced cereals must be transported from the place of production to the place of consumption with the involvement of different actors. For the purpose of our analysis, we have identified two cereal prices namely the producer price and the consumer price. Producers may sell their cereal products directly to rural and urban consumers (around 33%), to rural assemblers (around 10%), to retailers (around 20%), and to regional wholesalers (33%) or to a combination of them (Gabriel, A.H., Proceedings of the Food Security Conference, 2003, pp. 223).

We call the price of cereals at which the producers sell their products to be producer price. In CSA (2011) surveys producer price is defined as "the price of the transaction carried out by the peasant / producer at the first point of sell for a clearly specified agricultural product". Consumer price refers to the price of cereals in the urban areas. As a considerable portion of the population is living in the urban areas, far from the area of cereal production, they do not have access to the producer market. Rather they buy from wholesalers or retailers.

It should be clear that the purpose of operating, a split in cereal price as producer and consumer price, is to examine the revenues of producers generated from agricultural and spent to agricultural input. In the model we identify the producers' cereal price as a stock and an adjustment to the indicated price is used to set the producer price of eight cereals: tef, wheat, maize, barely, rice, sorghum, millet, and oats. For the purpose of simplification, we claim that the stock representing the producer price is an annual adjustment based on the inventory ratio, producer price inflation rate, and the producer price itself. We prefer this price adjustment instead of using input and labor cost for production because of the unavailability of well organized research on the production of cereals of each type. But the producer price inflation rate is a strategic way of capturing all the changes associated with production cost and other changes originating from substitutes. Figure 36 shows the producer price of some cereals.

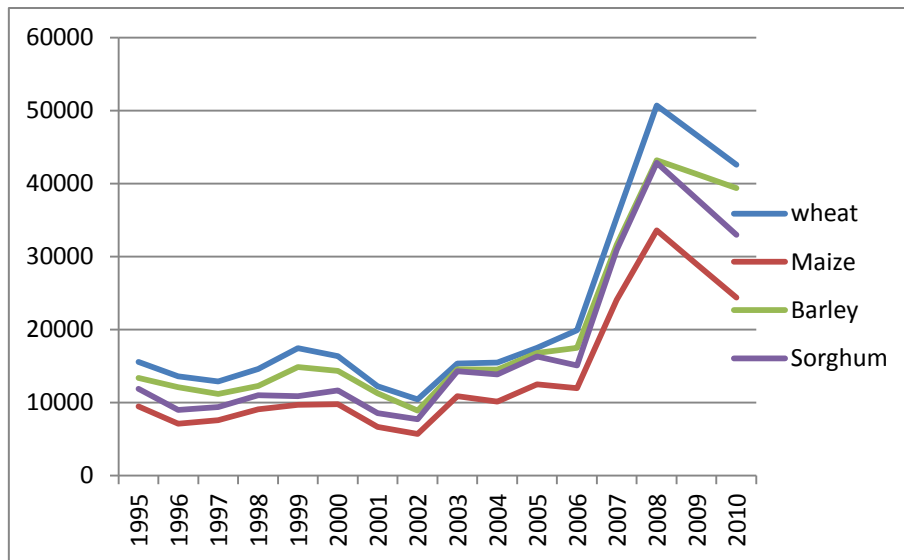

Figure 36: shows the producer price of some cereals.

Source: FAOSTAT

We define inventory ratio as the quotient of the cereal inventory and the indicated cereal inventory, where the indicated cereal inventory is the amount of desired cereals that should satisfy the effective market demand of the population. As reviewed in the literature the availability of cereals on the inventory is one of the variables considered in price setting (Demeke M. 2003, Proceedings of the Food Security Conference p.5). It has been observed that in the main production season the price drops, as there is sufficient supply (higher inventory ratio), while the price increases during the summer season (June- August) when running out of cereal stock (the inventory ratio is getting lower). Since almost all kind of cereals are substitutes of each other in the food consumptions of the population, it is difficult to calculate a separate inventory ratio for each of them. In the scarcity of one of the cereals, typically results in a slight increase in its price, then cereal consumers tend to use the substitutes i.e. the change in price is directly transmits to the substitutes. Thus it is the availability of the total cereal in the inventory, rather than the availability of the individual cereals in the inventory that potentially has an influence on the desired producer price. In our model we use the inventory ratio of the total cereals rather than the inventory ratio of each cereal when determining the desired producer price. A graphical function shown below is used to represent the effect of the inventory ratio on desired producer price.

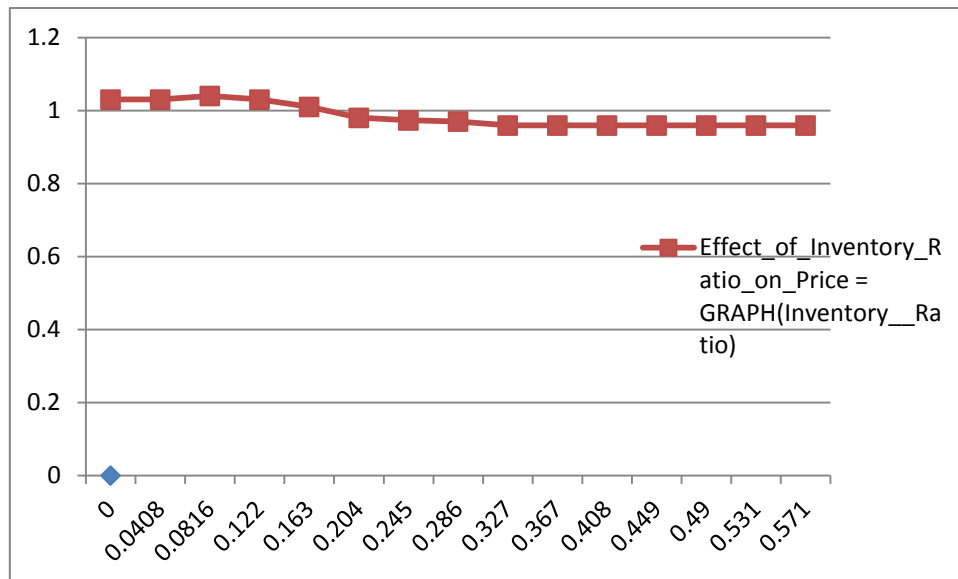

Figure 37: The effect of inventory ratio on desired producer price.

This graph implies that the effect of inventory ratio is higher than one, when the inventory ratio is less than 0.163 (the indicated producer price is pushed to rise due to insufficient cereals in the inventory) and the effect of the inventory ratio is less than one when the inventory ratio is higher than 0.163 (the desired price is pulled down as there is sufficient cereal in the inventory).

Another important factor in setting the indicated producer price is the producer price inflation rate. It is beyond the boundary of this research to explain the inflation rate endogenously, but it is evident that indicated producer prices are set depending on the relative change of price of similar products. And it is important to consider as an exogenous variable in the model.

The indicated producer price is the adjustment of the producer price with the producer price, the effect of inventory ratio, and the producer price inflation rate results in. A first order adjustment producer price and indicated producer price with a price adjustment time of one year results in the change in producer price of the current year.

$$\text{Changein_producer_price}[\text{Tef}] = (\text{Indicated_Producer_Price}[\text{Tef}] - \text{Producer_Price_per_000_Quin}[\text{Tef}]) / \text{Price_Adjustment_Time}$$

By addressing questions like; how the cereal arrives to consumers? And who is involved in the process? Could yield fundamental explanation for how the consumer prices in the urban areas arise. Cereals bought from the producer market (at producer price) by rural assemblers, need to be transported into the urban areas. The transaction involves more actors involved, several actors such as brokers, regional assemblers, wholesalers, and retailers (Gabriel, A.H., Proceedings of Food Security Conference, 2003, pp. 223). The cost of transaction increases

depending on the number of actors involved. Moreover, transportation costs, including fuel costs are influential in determining consumer price. On the other hand, the available market networks especially road and telephone network, are also important variables that needs to be considered in the adjustment of the consumer price.

In the last one and a half decades, the retailer fuel price (diesel) has increased from 0.24 to 0.78 US dollars per liter from 1995 to 2010. Correspondingly, in local currency (Birr), it has increased from 1.37 to 14.41 birr per liter from 1995 to 2010. Figure 38 shows the development of diesel, and gasoline retailer price in US dollars.

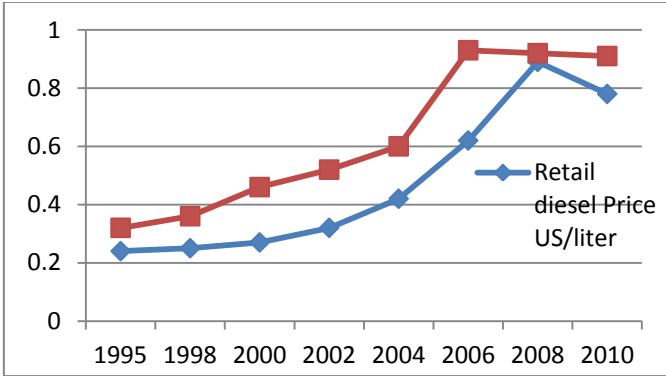

Figure 38: The retailer fuel price of Gasoline and Diesel in USD.

Source: International fuel price (2010/11).

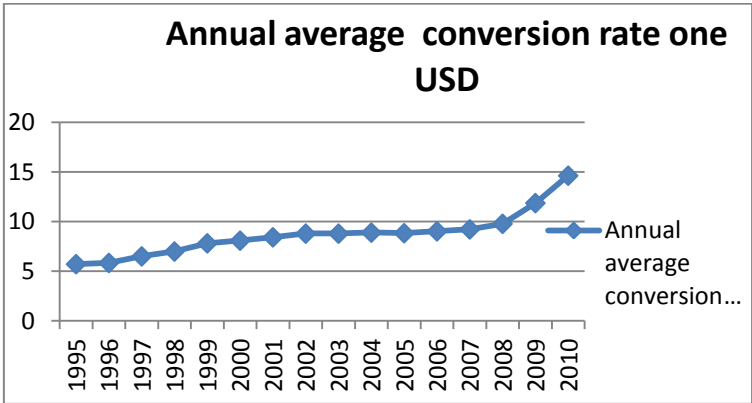

Figure 39: The currency exchange rate of USD in to Birr.

Source: OANDA

On the other hand, the road network grown by a factor of two, from 23442 Km in 1995 to 44359 Km in 2007. We used an estimated markup fraction (benefit margin of merchants in the cereal market system), and the relative change in fuel price and total road network,⁵ together with their estimated elasticity, to calibrate the consumer price in the model. Figure 40 shows the development of total road networks over time.

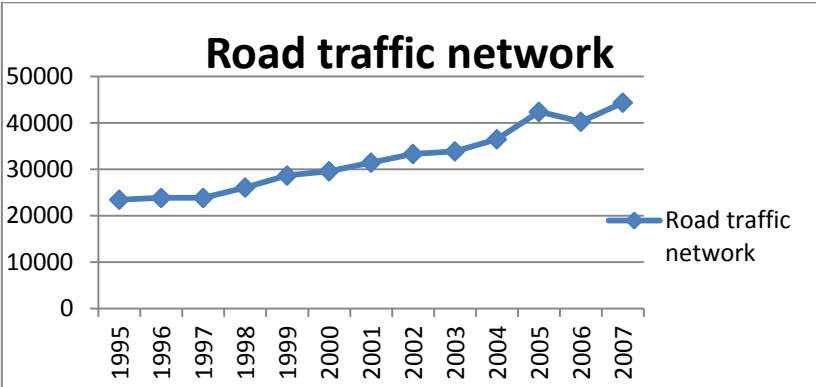

Figure 40: The development of total road network in the country.

Source: World Bank.

The effect of fuel price and road network on retailer price is computed using the relative fuel price and the relative road network with their elasticity. The higher the relative change in the road network the lower is its effect on the price, and the higher is the relative change in fuel price the higher is its effect on retailer price. The elasticity of fuel price is less than the elasticity of the road network.

The equation of retailer consumer price of cereals (Tef) is given below.

$$\text{Consumer price} = \text{Producer_Price_per_000_Quin}[Tef] * (1 + \text{Markup_Fraction}) * \text{Effect_of_Fuel_Price_and_Road_network_on_Retailer_Price}$$

The model structure of cereal price adjustment is given below

Total road network⁵ includes motorways, highways, and main or national roads, secondary or regional roads, and all other roads in a country (World Bank indicators).

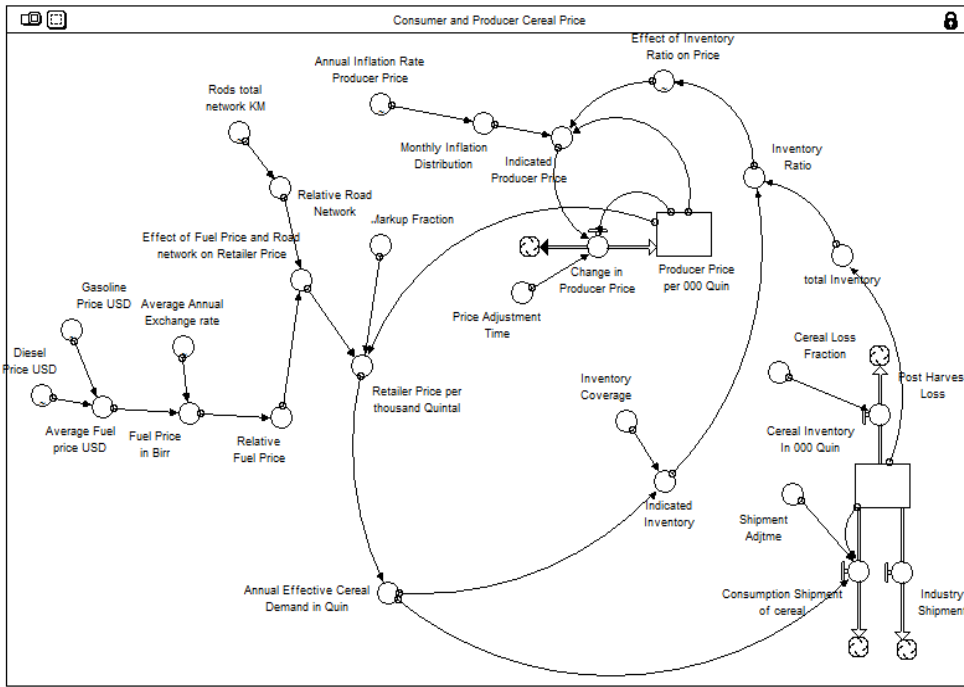

Figure 41: The model structure of both producer and consumer price adjustments.

3.3.2.6 Revenues, Agricultural Inputs and Yield

In our model based analysis, we also addressed the interaction of the of the variables; (a) the producer price, (b) revenues obtained from the sale of production, (c) the agricultural input investments (chemical fertilizers and improved seeds), and (d) the yield per hectare (or production in general) in a causal loop structure. Thus, we examine the causal relationship between the producer price (revenue obtained from the sale of production) and the agricultural yield (production) and the vice-versa.

We represent cash (local currency) by a stock, having one inflow ‘revenue’ and one outflow ‘revenue spending rate’. The inflow (revenue) is defined as the amount of all cereal sell shipments multiplied with the producer price of each cereal for the given year. Since our analysis covers the main season production (Meher), the sell shipment is part of the consumption shipment which is only produced from the Meher season production (Meher deliveries minus the cereal loss rate). This, Meher consumption shipment should be adjusted with the sale fraction of cereals (only around 16 % of Meher delivery before post-harvest loss is supplied in the market for sale).

The outflow ‘revenue spending rate’ is a first order adjustment of the accumulated revenue (cash) in one year. i.e. the amount of revenue, obtained from the sale of production, accumulated for one year is expected to be spent for other kinds of consumptions, investments for agricultural input (chemical fertilizer, improved seed, pesticide) or ,most likely, for both purposes. But here we need to consider the actual situation how farmers are investing/or acquire agricultural inputs, in this regard the government has been offering loan to farmers. Alternatively farmers can acquire agricultural inputs (especially fertilizer) for credit, based on an agreement with the local government (Matsumoto, T. et al., 2010). The deal is usually to return the loan at the next harvest time. Therefore our model must capture this condition as a delay. Moreover, in the formulation of revenue it should be noted that only a proportion of the population has been using agricultural inputs. That is, even if all the sales generate revenues, not all producers tend to use the revenues for investments on agricultural input to increase production.

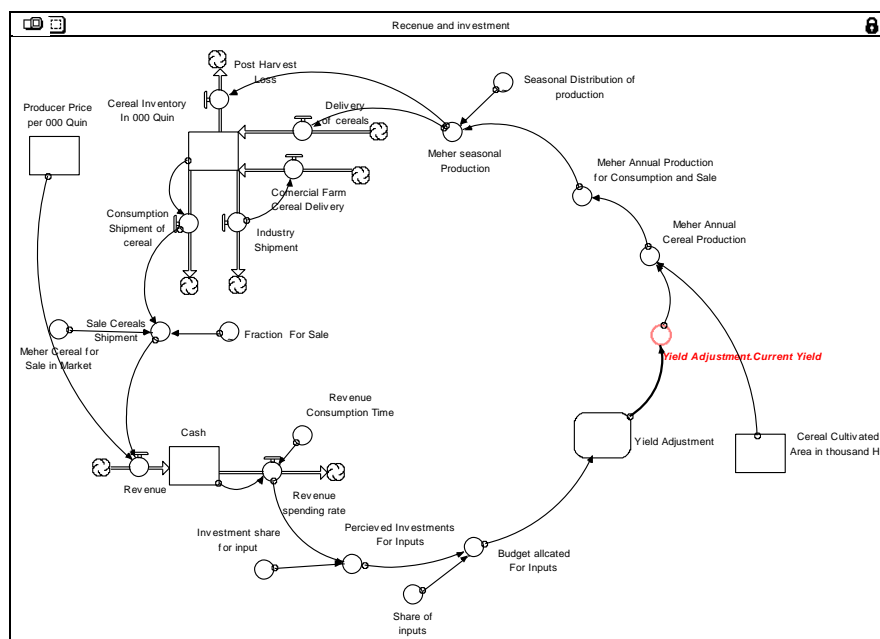

Figure 42: Market and investment, and yield model structure

Normally, a proportion of the populations invest revenues for agricultural input (because the coverage of inputs is considerably low), depending on their decision. The farmers’ decision depends on a number of factors such as; the return value of input, awareness of the benefits, access to the inputs or credit, expected price of production, instability of environmental conditions especially rainfall etc. are mentioned in literatures (Matsumoto, T et al. ,2010, Dercon, S. et al., 2009).

As it is complex to capture all the decision variables in the model, we defined a variable which is used as an attractiveness measure of input investment. Relative attractiveness of investment is defined as the ratio of change in revenue obtained from the additional use of input to the change in costs of input. It is based on the assumption that additional cost for additional input use produces additional yield/production; the sale of this additional production with the current producer price generates additional revenue. Hence, if this ratio is higher than one it is relatively attractive, while a ratio less than one indicates that the investment is not attractive. We also claim that the attractiveness of a high return on investment causes additional use of agricultural input by farmers and also inspires other non-input users to use such input (further expanding the area coverage of the input).

Hence the budget for input is determined by the shares of investment for fertilizer and improved seeds. The budget allotted for purchasing either fertilizer or improved seed is divided by the retailer price of fertilizer and/or improved seed to obtain the amount of fertilizer and improved seed required to purchase. As availability of inputs has been a constrained in the market (Dercon, S. et al. 2009, Croppenstedt, A. et al. 1996), we use a minimum function of desired amount of cereal input to be purchased and available input to obtain the amount of purchased cereal inputs from market. The historical total (country) consumption of fertilizer is shown in figure 43 below.

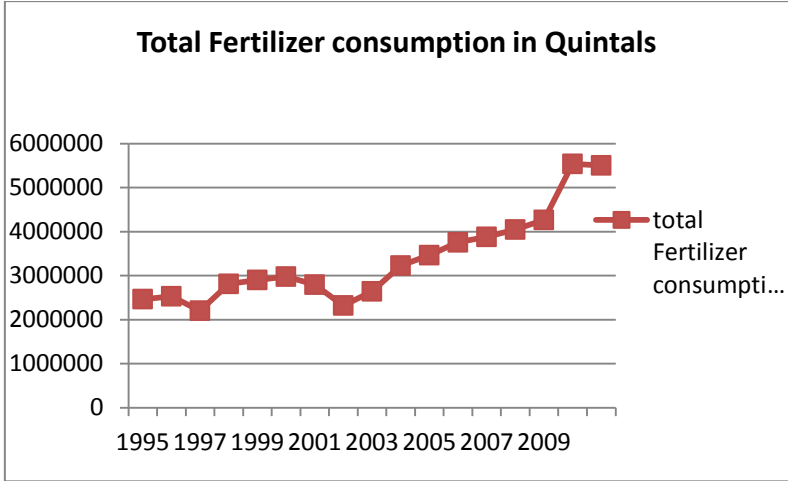

Figure 43: Total fertilizer consumption author computation.

Source: MoA

The annual amount of improved seed sale of cereals by the largest producer ESE (Ethiopian Seed Enterprise) is provided in the table below.

CROP	Year									
	2001	2002	2003	2004	2005	2006	2007	2008	2009	2010
Wheat Total	7935	91063	138937	64234	115888	75602	121748	123215	221363	186360
Maize Total	25683	59133	50654	48791	46650	54748	41934	38270	50715	31031
Barley Total	534	1582	4534	4578.5	10023	6355	6457	9053	7358	7077
Teff Total	508	1616	1335	2072.3	3527	5816	6541.48	7872	11199	13186
Sorghum Total	63	0	189	443.3	139	279	786.875	1504.2	1039.9	277.2
F.Millet Total	0	2	12	37.1	26	234	213	145	306	
Total Rice	0	0	0	0	0	0	0	0	42	300
Annual total	34723	153396	195661	120156	176253	143034	177680	180059	292023	238232

Table 12: Annual improved seed sales of ESE

Source: Author computation from ESE

It is also important to discuss the retailer price of fertilizer and improved seeds. The price of fertilizer and improved seed has increased progressively. The fertilizer price has increased fourth fold in one and half decades. Figure 44 shows the development of fertilizer price over the time under consideration.

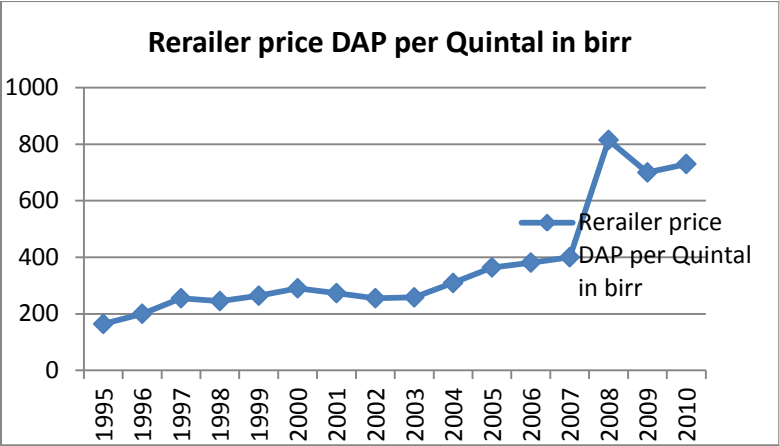

Figure 44: The development of fertilizer price over the time under consideration

Source: Author composition from MoA and Rashid, S. et al. (2012).

The price (Birr/Quintal) of some improved seed of cereals from 1995 to 2002 is shown in the figure 45 below.

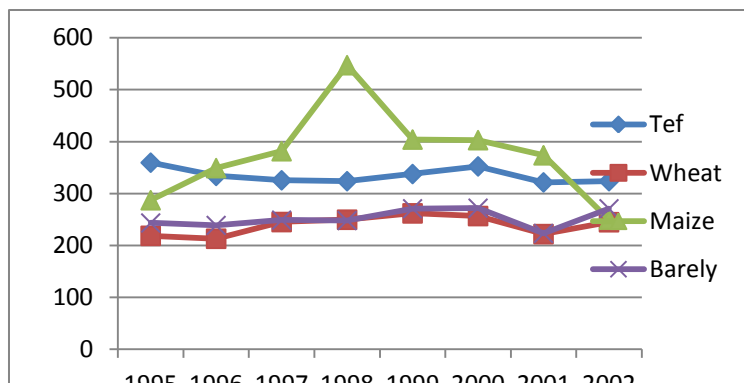

Figure 45: Improved seed price (birr per-quintal).

Source: Author computation from Bale Agricultural Development Enterprise report.

It has been documented in the literature that the agricultural input coverage has not expanded much during the last decades. The following table summarizes the historical input coverage which is used for calibrating the model.

Input used on cereal crop 1997/8 to 2007/8	1997/8	2001/2	2007/8
Fertilizer applied area(% total area cultivated)	32.3	42.8	39
Fertilizer Application (Kg/ha, total cultivated area)	37	30	45
Fertilizer Application (Kg/ha, fertilizer applied area)	115	100	115
Improved seed Coverage (% of crop area)	2.4	3.5	4.7

Table 13: Cereals input coverage.

Source: Dercon, S. et al. (2009)

In the model, a minimum of the amount of desired fertilizer to be purchased (which is the result of investment from the revenues computed above) and a graphical function of the amount of fertilizer supplied for the last one and half decades is used to obtain the cultivation area covered by this input for each cereal type. For the purpose of further analysis major classification of input coverage's is applied namely; cultivation area coverage by both inputs (fertilizer and improved seed), cultivation area coverage by fertilizer only, and cultivation area not covered by any of the inputs. As the fertilizer coverage is much higher than improved seed coverage, we do not apply the coverage option with only improved seed.

On the other hand, and most importantly, the amount of fertilizer input used per hectare with the three coverage's identified in the above paragraph should be examine in response to yield of a particular cereal. In this regard, we organize some research results on yields of cereals when both fertilizer and improved seed were applied, when only fertilizer was applied, and when neither fertilizer nor improved seed was applied. For example, the following two tables show table 14 and table 15 yields of some cereals in the traditional Vs improved technology and survey results respectively.

The response of cereal yield to the use of fertilizer has been reported differently by different researchers. For example, Rashid, S. (2009) has presented the elasticity of maize yield for fertilizer, and fertilizer and improved seed, to be in the range 0.16 - 0.18 and 0.26 - 0.35 respectively. However, Cropponsted, A. et al (1996) has estimated the elasticity of most cereal including maize to be 0.198.

Yield (ton/ha) of cereals, including maize is shown in table 15 below.

Crop	NAEIP (1995-1999)		Sasakawa Global 2000 (1993-1999)		Recent farm yields (2000-2004)
	Quintal/Ha				
	Improved	Traditional	Improved	Traditional	
Maize	47.3	15.7	46	15.7	18.2
Wheat	29.3	11.7	23.1	9.5	13.1
Sorghum	27.9	11.2	20.8	9.2	12.1
Tef	14.3	8.5	16.2	6.4	8.2
Barely	21.5	10			10.5

Table 144: Yield of cereals with improved technology and traditional trials

Source: Dercon, S. et al. (2009)

The results presented in table 14 are criticized to be high (3-times) to represent the country average yield as it is a trial (demonstration) in NAEIP (National Agriculture Extension Intervention program) and Sasakawa Global 2000 program. The reason for high yield in Sasakawa Global 2000 program is associated with the uses of high agricultural potential sites, and the participants involved in the program had larger land, more man power, greater livestock wealth and higher level of literacy than the average farmers (Dercon, S. et al. 2009).

Yu, B. et al. (2011) has reported the yields of cereals organized from four years statistical survey by CSA from 2003/04 to 2007/08 shown in the table 16 below.

Crop	Fertilizer		Improved seed	
	Non- adopted	Adopted	Non-adopted	Adopted
Maize	16.6	20.5	16.8	22
Wheat	12.5	16		
Tef	9	10		
Barely	10.9	12.7		

Table 155: Average yield of cereals

Source: Yu, B. et al. (2011)

The results of table 14 and table 15 shows that there is significant difference between the cereal yield from farm trials and the actual average yield surveyed. And also it implies that Ethiopia can potentially increase the cereal yield obtained if appropriate measures are taken.

Finally, joining the input variables for the current yield; relative inherent yield from the land use sector (section 3.2.2.1), effect of rainfall (exogenous), relative fertilizer used together with its elasticity, and average yields of cereals weighted with the three input coverage i.e. both fertilizer and improved, only fertilizer, and neither fertilizer nor improved seed (traditional seed) resulted in the current cereal yield of each cereal. Figure 46 shows the model structure of computation of yield.

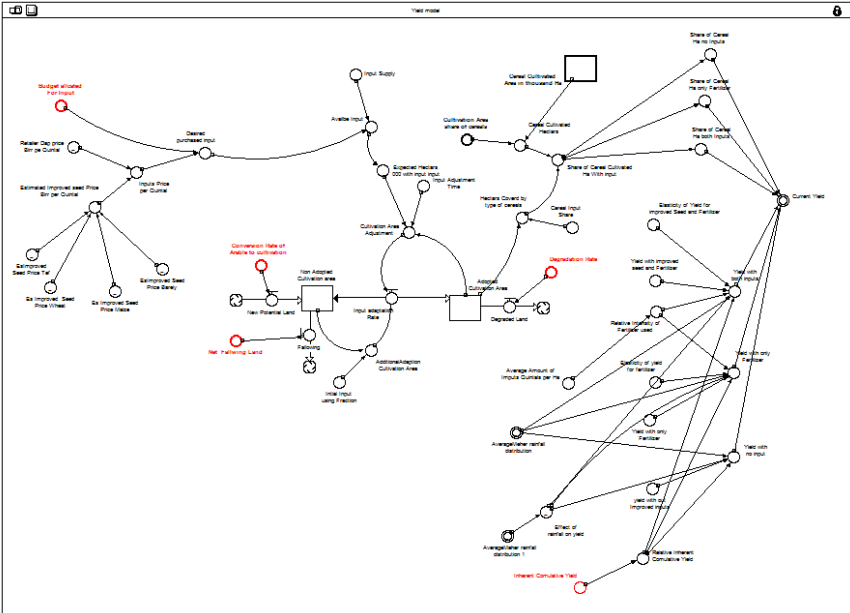

Figure 46: Model structure of yield

The red variables in the above figure 46 are variable joining from other sectors (market and land).

3.3.2.6 Undernourishment

One of the important parameters that have been used to measure the extent of food insecurity by the giant organizations, FAO and the World Bank is the prevalence of undernourishment. According to the definition of FAO, (FAO-statistics division) “undernourishment refers to the condition of people whose dietary energy consumption is continuously below a minimum dietary energy requirement for maintaining a healthy life and carrying out light physical activity with an acceptable minimal body-weight for attained height”. And the prevalence of undernourishment is the percentage of population in a condition of undernourishment.

In the previous section we have discussed the annual desired cereal consumption, computed based on the minimum adult equivalent daily calorie intake and the annual effective cereal consumption, computed based on the average purchasing power the population. The annual desired cereal consumption is constrained by the annual desired effective cereal consumption of the population (economically constrained). As a result, a minimum equation is used. However, the annual effective demand is also constrained by the availability of cereals in the inventory (physical access). The actual shipment of cereals could only take place if there is sufficient amount of cereals in the inventory, to satisfy the annual desired effective consumption.

$$\begin{aligned} \text{Annual_Desired_Effective_Cereal_Consumption}[Tef] = & \\ \text{MIN}(\text{Annual_Desired_Cereal_Consumption_in_thousand_Quintals}[Tef], & \\ \text{Bedge_Alloted_for_cereal_Consumption_per_year}[Tef] / \text{Retailer_Price_per_thousand_Quintal}[Tef]) & \\ \text{Consumption_Shipment}[Tef] = & \\ \text{MIN}(\text{MAX}(0, \text{Cereal_Inventory_In_000_Quin}[Tef] / \text{Shipment_Adjtm}), & \\ \text{Annual_Effective_Cereal_Demand_in_Quin}[Tef]) & \end{aligned}$$

A similar set of equations is used for each of the cereals.

At this stage of explanation, we know the annual desired cereal consumption of the population and the actual effective cereal consumption of the population. The next step is to convert cereal units into appropriate hundred grams of cereals followed by the conversion of these cereals into annual Kcal of energy (using food composition table) which is desired to be consumed and actual consumed by the population. Subsequently, dividing the annual desired Kcal of energy consumption and the annual effective Kcal of energy consumed by the annual desired Kcal per-capita results in the desired population nourished (total population) and effective population nourished, respectively in the given year under consideration. Hence, the

prevalence of undernourishment is the ratio of the population not effectively nourished with the desired population nourished (total population). The equation is given below.

$$Prevalence_of_Undernourishment = \frac{(Desired_Population_Nourished - Effective_Population_Nourished)}{Desired_Population_Nourished}$$

It is part of our analysis to examine the causal interactions of the various variables discussed so far and, most importantly, we need to close the loop we have seen in the population sector (figure 27). The model structure of the above explanation is presented in the figure 47 below.

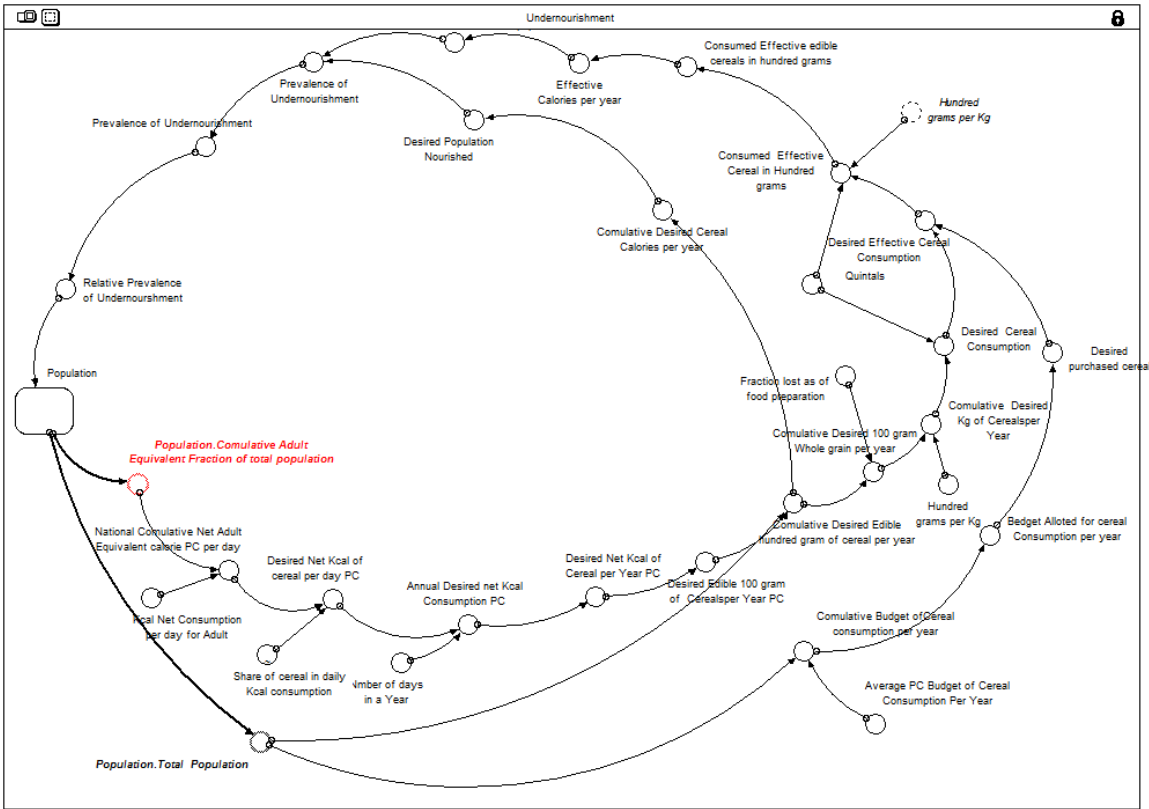

Figure 47: Prevalence of undernourishment

In the literature MH (2003), Ali, M.et al.(2011) have pointed that health problems in a large portion of the population emanate from the lack of an adequate and well balanced diet. Malnourishment, that encompasses undernourishment, diminishes people’s ability to work, and care for themselves and ultimately exposes them to diseases. Children, pregnant and lactating women, and aged adults are the most vulnerable population resulting from malnourishment. Besides the health problem and malfunctioning, a study in Ethiopia in 1996 has indicated that nutritional deficiency accounted for an estimate of 7.8 % of all deaths and 9.3 % of discount life years lost (Gebremariam, A.et al., 2005, p. 131-164).

Chapter Four: Model Validation and Behavioral Analysis

Model validation is an important aspect of any model based analysis. Models are useful tools as far as they are able to generate the right behavior for the right reasons. The purpose of model validation is to build confidence in the usefulness of the model for the intended purpose. Model validation should be conducted at each stage of the modeling process, starting from the conceptualization till the policy recommendation (Barlas, Y., 1994).

4.1 Direct Structure Test

In chapter three we have presented both the causal-loop and stock-flow model structure, with which we describe the systemic interaction between various parameters resulting in the problematic behavior. The model structure represents the causal hypothesis describing the interaction between different actors over time. Hence, the validity of the model depends on the validity of the model structure representing the hypothesis.

The conceptualization and definition of the model structure is based on solely the knowledge's of experts portrayed in the literature, discussion with field experts. As it is documented in the description of the model, a number of documents, research results, and surveys have been used in the development of the model structure. We used time serious surveys data (from CSA, World Bank, FAO), expert consultation, and various literature in the conceptualization and estimation of some model parameters. We used sensitivity analysis in section 4.5 to examine the model sensitivity to several of the estimated parameter values.

4.2 Unit consistency Test

One of the model validation methods is checking unit consistency. It is fundamental to check all the units in the model such that they are consistent and are representing exactly the intended variable. In the model we have checked the consistency of all the units. Some of the variables and the associated units are given below in the table 16.

Name of variable	Type of variable	Unit
population	stock	people
birth rate	flow	people/year
net migration fraction	auxiliary	1/year
desired Kcal share of cereals	auxiliary	unit less
prevalence of undernourishment	auxiliary	unit less
desired cereal demand	auxiliary	quintals/year
cereal cultivation land	stock	hectares
degradation rate	flow	hectares/year
current yield	auxiliary	quintals/(year*hectares)
revenue	flow	birr/year
producer price	stock	birr
becoming suitable land	flow	hectares/year
fertilizer coverage	auxiliary	unit less
inventory	stock	quintals
meher cereal production	auxiliary	quintals/year

Table 16: Unit of some variables

4.3 Reference and Model Simulated Behavior Test

Model validation process includes the comparison of the simulated model behavior with the historic behavior. In other words, it is an assessment made to check whether the simulation results that are model produced represents sufficiently well the behavior of the system modeled, i.e. captures the main properties of the behavior.

We used a metric to assess the goodness of-fit which is summarized in the table 17 below. The first measure of fit is the coefficient of determination, R^2 , measures the fraction of the variance in the data explained by model. The value of the coefficient of determination lies between 0 and 1. If the model exactly replicates the actual data then $R^2 = 1$; if the model output is constant $R^2 = 0$ (Sterman, J. 2000). As shown in the table 17, the coefficient of determination (R^2) is close to one for most of the variables which means the model explains important fraction of the variance in the data of each variable. Or the R^2 implies that the model replicates the behavior patterns of the historical data. The R^2 of cereals, in general, is relatively small; tef- $R^2 = 0.88$, wheat $R^2 = 0.74$ and maize $R^2 = 0.66$. The comparison graph of model simulated and the historical data for some selected variables are shown in figure 29 below.

The second metric in table 17 represents the mean absolute percentage error, MAPE -mean absolute error as a percentage of the mean. MAPE provides measures of the average error between the simulated and historical data (Sterman, J. 2000). There is no reference to compare MAPE, but it is always better to have a lower percentage. For the purpose of this model a value less than 15 % represents a lower error between the simulated and historical data. From table 17, the MAPE of all of the variables is less than 15 % implying the error between the simulation data and the historical data is less than 15 %.

Among the model generated graphs portrayed in figure 48 (a-l), life expectancy figure 48 (b), and per-capita expenditure figure 48 (e), are partially made in the feedback loop with a 9% and 25 % of the historical data. Whereas the producer price of cereals in figure 48 (k & l) are highly derived by inflation rate, the others variables are endogenously produced by the model.

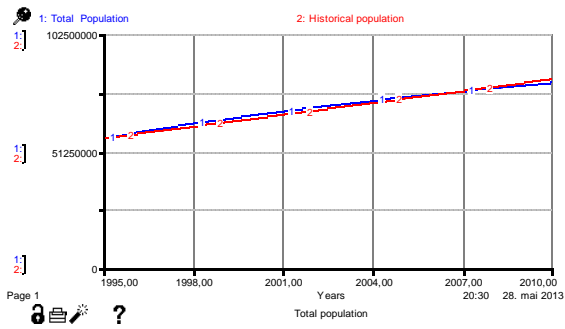

Figure 48 (a): Total population

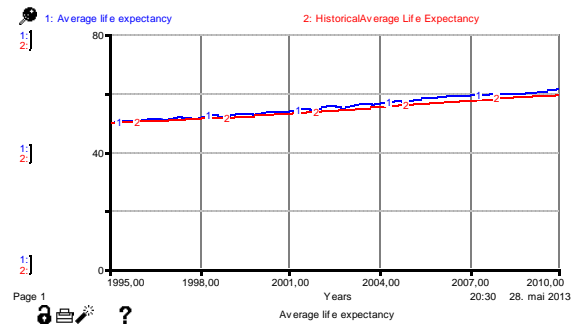

Figure 48 (b): Life expectancy

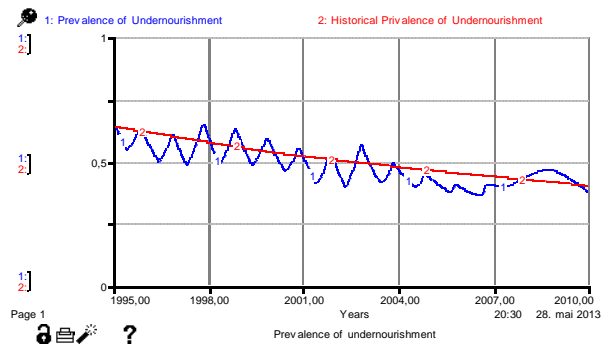

Figure 48 (c): Prevalence of undernourishment

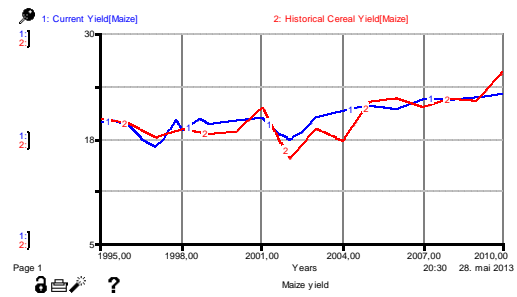

Figure 48 (d): Maize yield

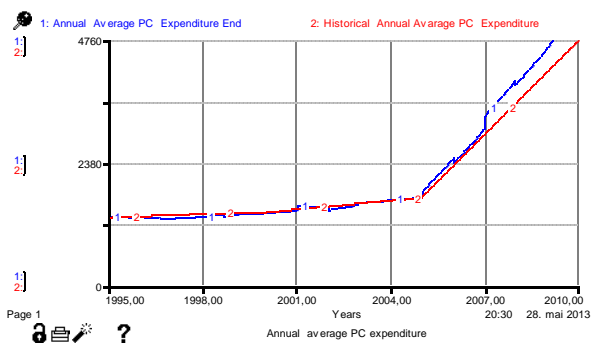

Figure 48 (e): Per-capita expenditure

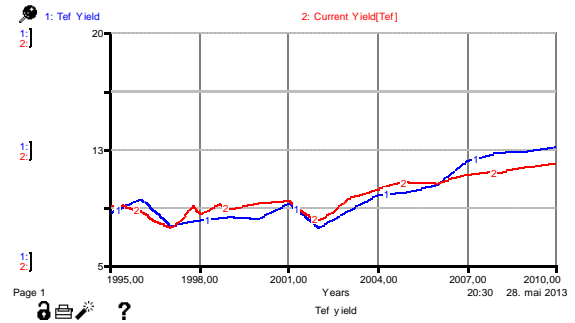

Figure 48 (f): Tef yield

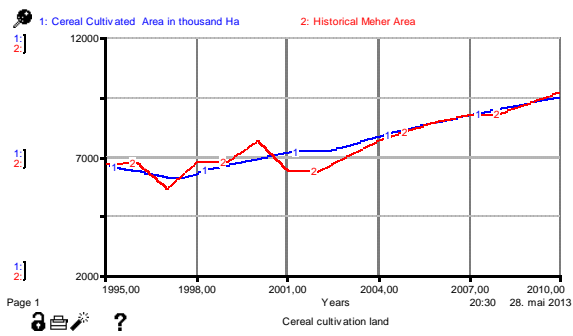

Figure 48 (g): Total Meher cultivation land

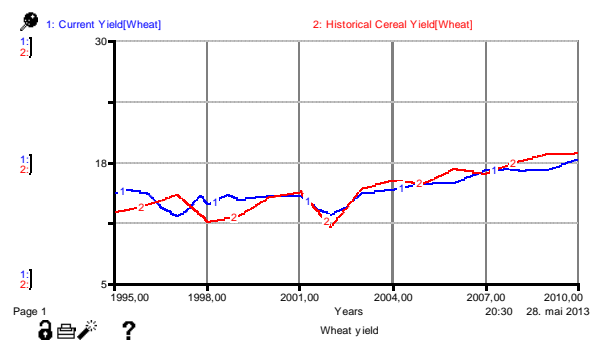

Figure 48 (h): Wheat yield

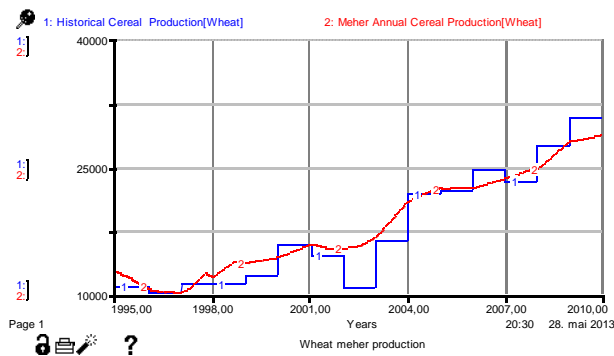

Figure 48 (i): Meher wheat production

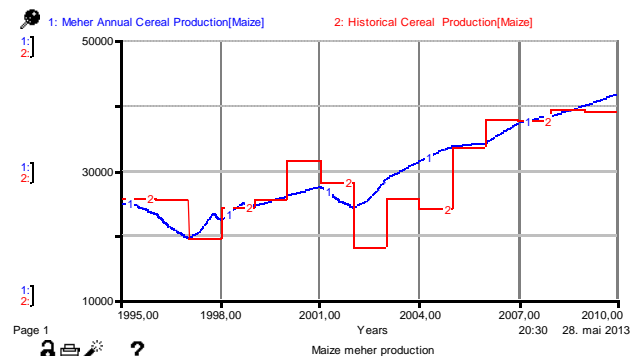

Figure 48 (j): Meher maize production

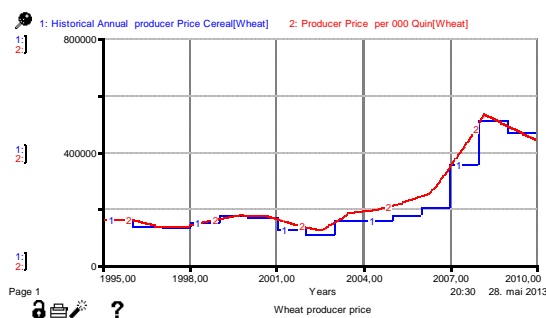

Figure 48 (k): Producer price of wheat

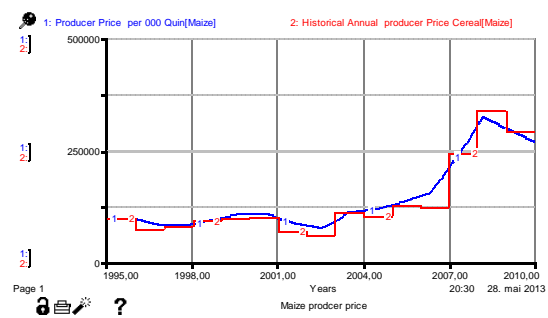

Figure 48 (l): Producer price of maize

Figure 48 (a-l): The comparison of historical and model generated graphs.

Finally table17 shows the Theil's inequality statistics. Theil's inequality statistics measures the sources of the error between the simulated and historical explained by; the difference of two means, bias (U^M), the difference in variance, unequal variation (U^S), or unequal co-variation (U^C) when the simulation result and data are imperfectly correlated. (Serman, J. 2000). The error for average life expectancy figure 48 (b) is mainly explained by the difference in the means of the simulated and the historical data, especially from 2004-2010. Whereas, the error for annual per-capita expenditure, figure 48 (e) is explained mainly by the difference in the variances of the simulated and historical data, the error for variables; population, prevalence of undernourishment, cereal cultivated land, yield production and price (all type) is manly explained by unexpected variability.

Variable	R ²	MAPE (%)	Theil's Inequality Statistics		
			U ^M	U ^S	U ^C
Population	0.99	1.34	0.24	0.28	0.48
Average life expectancy	0.99	1.85	0.77	0.19	0.25
Prevalence of undernourishment	0.86	5.56	0.26	0.002	0.73
Annual per-capita expenditure	0.99	4.8	0.22	0.74	0.04
Cereal cultivation land	0.87	4.6	0.03	0.02	0.95
Tef yield	0.88	6.4	0.003	0.43	0.56
Wheat yield	0.74	7.63	0.003	0.28	0.71
Maize yield	0.66	6.13	0.03	0.22	0.75
Wheat production	0.95	9.3	0.008	0.27	0.72
Maize production	0.81	9.39	0.01	0.17	0.81
Wheat producer price	0.97	10.9	0.2	0.07	0.72
Maize producer price	0.96	14.34	0.01	0.33	0.65

Table 17: The *Theil's inequality statistics*

4.4 Structure-Behavior Tests

Structure-behavior tests aim at assessing the validity of the structure indirectly, by applying some behavioral tests. In this section we examine the relationship between the model structure and its simulated behavior when some loops are cut. We test whether cutting of the loops; R2, R3, R7, and B5 have the same implication to the simulation behavior of the model.

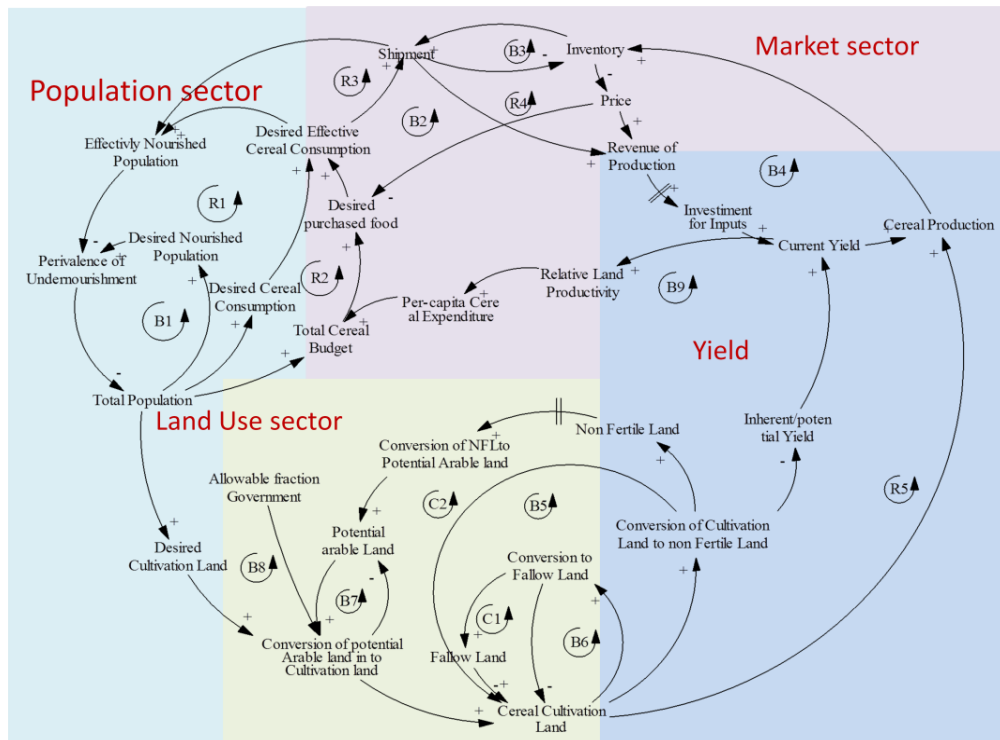

Figure 49: Causal loop diagrams of the main loops of the model.

We call the simulation result before the loops are being cut as the business as usual (BAU) run, using the structure that replicates the reference behavior. And we compare the model simulation before and after the loops are being cut.

The dynamics of the desired effective cereal consumption of the population is governed by the reinforcing loop, R2. That is, the loop R2 computes the amount of cereals needed for consumption, given that the total budget for cereal which is computed based on the purchasing power of the population. R2 constrains the available food consumption in case when people cannot afford to buy food / cereals. Without the presence of the loop R2 i.e. without the budget constrained, all the available cereal in the market will be consumed. Therefore, there is a reduction of prevalence of undernourishment as well a drain of cereal inventory in those years where the purchasing power was a constrained.

We cut R2 by directly taking desired cereal consumption into the consumption shipment instead of desired effective cereal consumption. The result of cutting loop R2 is shown in the figure 50 below, for prevalence of undernourishment and Maize cereal inventory, respectively.

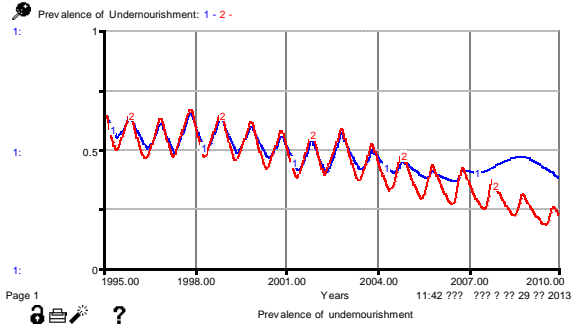

Figure 50 (a): Prevalence of undernourishment

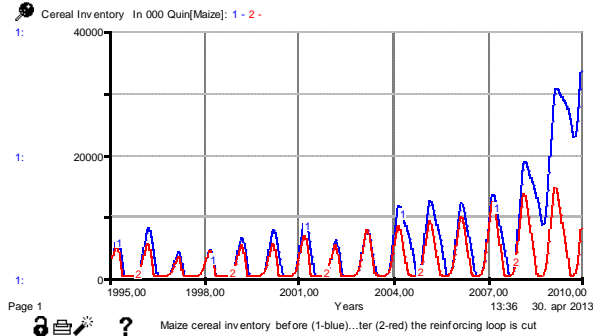

Figure 50 (b): Maize cereal inventory

Figure 50: The comparison of the simulation results with the base run when R2 is being cut, before (1-blue) and after (2-red).

From figure 50, in the condition when the purchasing power is not a constrained, the supply of food from the inventory has not been sufficient to feed the total population. Further, the prevalence of undernourishment has shown improvements especially from 2005 to 2010 i.e. the purchasing power was the main constrained for the undernourishment experienced from 2005 to 2010.

The behavior of the base run of cereal inventory shows oscillation throughout the simulation, this is mainly caused by the seasonal delivery of the Meher production. In the production season the inventory becomes relatively high, but due to the huge shipment depleting the inventory, the inventory becomes relatively low soon after the main delivery season. However the cereal inventory began to accumulate starting from 2008 following the decline of shipment which is caused by the rapid increase in price.

The base run of the prevalence of undernourishment oscillates (from 1995 to 2007) as resulted from the oscillation of the food inventory. The oscillation implies that the food supplies were not sufficient to satisfy the desired effective consumption. But the relatively higher desired effective consumption than the actual availability of food (shipment) could never happen in ideal market where the price immediately adjusts to lower the desired effective consumption. However, in the actual market(s) especially where there is no developed infrastructure that involves huge transportation cost to transport food from one market to the other, the situation could easily be experienced. The decrease in amplification of

the oscillation (from 1995 to 2007) and finally smoothing (from 2008 to 2010) signifies the development of infrastructure in transmitting price through the various markets.

Up on the removal of financial constrained from consumption, the cereal inventory stops from being accumulating as there is very high desired consumption to deplete the cereals from the inventory. Hence the simulation result of the prevalence of undernourishment shows improvements on those years where the purchasing power were the constrained (especially from 2003 to 2010).

Secondly, the reinforcing loop R3 constrains the desired effective cereal consumption. In the case where there is no sufficient cereal in the inventory for the given desired effective cereal consumption, consumption shipment is the main constraint governing the actual cereal consumption of the population. Thus the reinforcing loop R3 reduces consumption and increases the prevalence of undernourishment in the situation where there is not a sufficient supply of cereal in the inventory i.e. when the effective cereal consumption demand is higher than the consumption shipment. In this case the people consume more than what is being produced, and this may only be done through imports.

If the reinforcing loop R3 is cut, then we expect that the amount of cereal consumption will be higher during years when the consumption shipment was a constrained (1995-2008). As a result, the prevalence of undernourishment will be lower (improves). Since the oscillation of undernourishment shown in the base run has been generated with the constrained of the consumption shipment in place, we also expect the oscillation to be smoothed when the constrained is lifted.

We cut the reinforcing loop R3 by changing the equation of consumed consumption effective cereals from minimum to maximum function. The result compared to the base run, is shown in the figure 51 below.

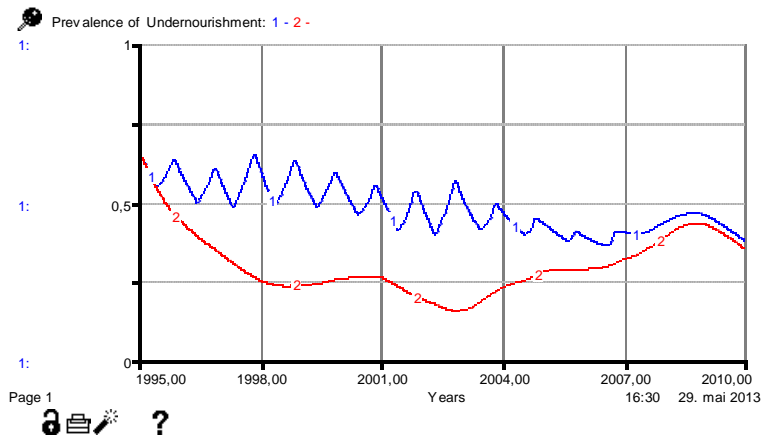

Figure 51: Comparison of the simulation results of prevalence of undernourishment before (1-blue) and after (2-red) the loop R3 is being cut.

As shown in the figure 51, the prevalence of undernourishment has shown significant improvements (decrease) especially from 1995 to 2007, during which the shipment (food availability) was the main constrained. While the improvement in the prevalence of undernourishment observed from 2008 to 2010 was relatively small and this period was highly constrained by the purchasing power rather than the availability of food from the inventory.

Thirdly, let us examine the structure-behavior interaction of the reinforcing loop, R5. It is through R5 the cereal cultivation area is adjusted based on the growing cultivation area desire of the population. R5 is the cause of exponential growth in cereal cultivation area and declining prevalence of undernourishment. Without the presence of the reinforcing loop R5, the cereal cultivation area will not be expanding. As a result, we expect the cereal cultivation area to decline gradually. Moreover, the prevalence of undernourishment is also expected to be higher than before, because the production and supply of cereals will decrease in accordance to the decrease of cultivation area. Figure 37 shows the cereal cultivation area (a) and the prevalence of undernourishment before and after the loop R5 is being cut.

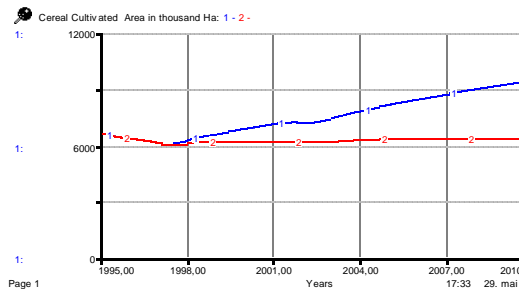

Figure 52(a): Cultivation land

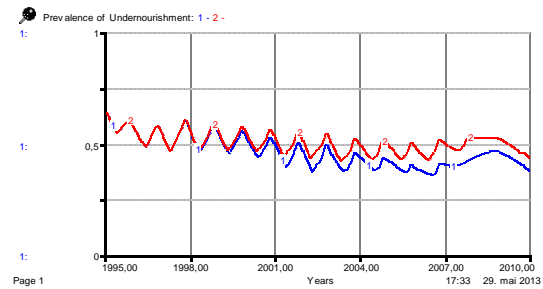

Figure 52(b): Prevalence of undernourishment

Figure 52: Comparison of simulation results of cereal cultivation area and prevalence of undernourishment when the loop R is being cut.

As shown in the figure 52, the cereal cultivation area does not expand after the loop (R5) has been cut. Similarly, the prevalence of undernourishment has relatively stopped declining. Thus, the behavior is consistent with our hypothesis. The real implication of this analysis is that the adjustment of cereal cultivation area according to the size of the population has increased the cereal cultivation area. This, in turn has contributed to an increase in cereal production subsequently leading to decrease the prevalence of undernourishment. This is consistent with the current literature stating that the increase in cereal production resulted from the increase in cultivation area.

The fourth behavior-structure analysis addresses the balancing loop B8. This loop covers the dynamics of land degradation where the cultivation land passes through the various stages of land suitable class (Top soil depth) through which the inherent fertility of the land declines. Without the presence of the balancing loop B8, the relative inherent yield as well as the actual yield is expected to be higher than in the base run.

We cut the balancing loop B8, by setting the top soil depth loss rate to a small (10^{-10}) value, so that the average life time of the land in each cohort will be very high. The simulation results are shown in the figures below.

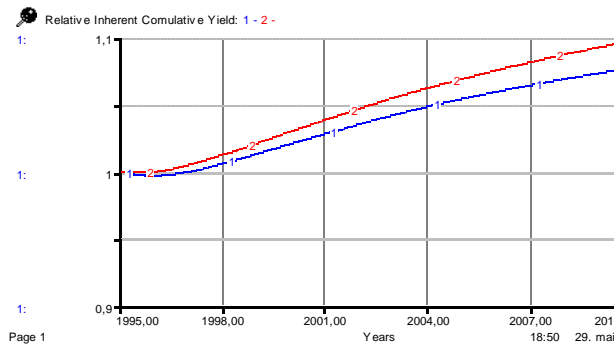

Figure 53 (a): Relative inherent / potential yield

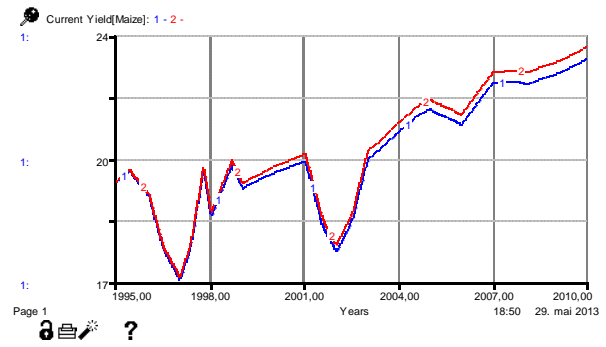

Figure 53 (b): Maize yield

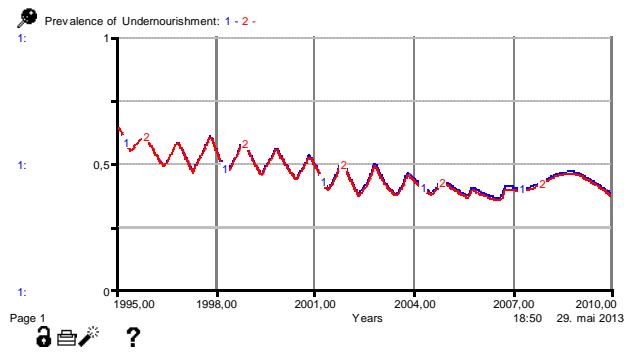

Figure 53 (c): Prevalence of undernourishment

Figure 53: Comparison of simulation results of relative inherent yield, maize current yield and prevalence of undernourishment when loop B5 is being cut.

As shown in the figure 53, the simulation result of relative inherent yield (a) is above the simulation result of the base run. That is the arresting of the soil degradation relatively increases the inherent yield. Similarly, the maize yield (b) has shown a better (higher) development compared to the base run up on the arresting of the soil degradation. However, the improvement of the prevalence of undernourishment (c) is not significant. But while we compare the improvements of relative yield, maize yield and the prevalence of undernourishment over the simulation years, the improvement (difference between the base run and the simulation after the degradation is arrested) has increase more in the last five years than in the first five years. This implies arresting the degradation process is more effective in the long run than in the short run to increase yield. Moreover, the degradation has not significantly affect the yield within the analysis of our time frame but the long process has had resulted in the decline in yield stated in the literature (section 1.1.3). To this regard a policy on arresting land degradation must be designed for long term. We will analyze this policy option in chapter five.

4.5 Extreme Condition Test

Another model validation technique in system dynamics is to check whether the model is plausible in response to extreme policies, shocks and extreme values of parameters. The model should be robust in extreme conditions meaning the behavior of the model should be realistic results even under extreme values for the input (Sterman, J., 2000). It should generate noted here that the extreme condition test does not necessarily imply the conditions exist in real situation. In this section we test the extreme values of some variables such as: Expenditure share of cereals, effect of rainfall, topsoil depth loss rate, and share of cereal in a daily Kcal consumption.

Let us assume the extreme minimum and maximum condition of expenditure share, when the cereal expenditure share = 0 and the cereal expenditure share = 1, respectively. The minimum condition implies that no one is willing to spend money buying cereals, and the maximum condition implies all of the expenditure is spend for cereal. Hence, under the first conditions (cereal expenditure share = 0) we expect the desired effective cereal consumption will be nil and no one has access to food. As a result, everybody will be undernourished (prevalence of undernourishment = 1). With the second condition (cereal expenditure share = 1) we expect that the desired effective consumption of cereals will be very high and everybody will access cereals as far as the inventory allows for it. We expect the prevalence of undernourishment will be lower than in the base run or even reduces to zero provided that there is sufficient cereal in the inventory and the budget is sufficient enough to buy food at the current price. Simulation results of these tests are presented in the figure 54 and 55 below.

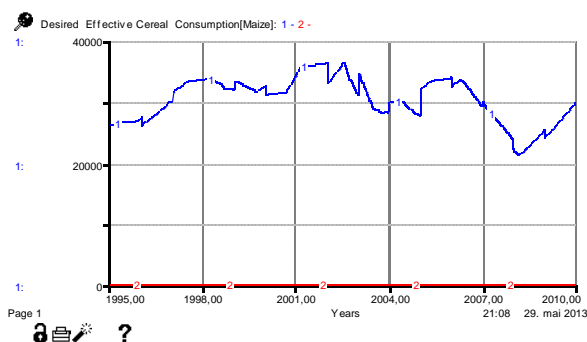

Figure 54 (a): Desired effective consumption of wheat and maize

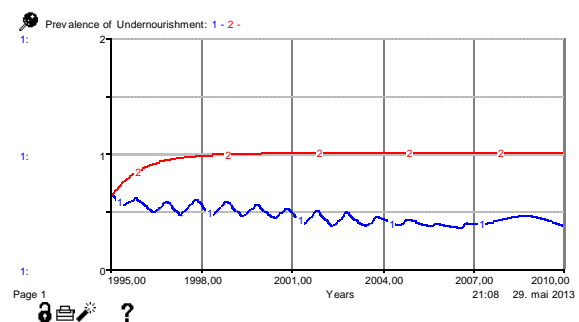

Figure 54 (a): Prevalence of undernourishment

Figure 54: Simulation results of desired effective cereal consumption and prevalence of undernourishment with the extreme minimum test (cereal expenditure share = 0).

As shown in the figure 54, the simulation result of desired effective cereal consumption (wheat, maize etc.) under the extreme minimum condition (cereal expenditure share = 0) becomes zero which has resulted in the prevalence of undernourishment to become one meaning everybody is undernourished.

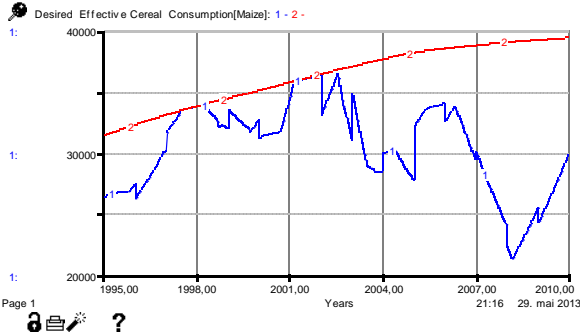

Figure 55 (a): Desired effective maize consumption

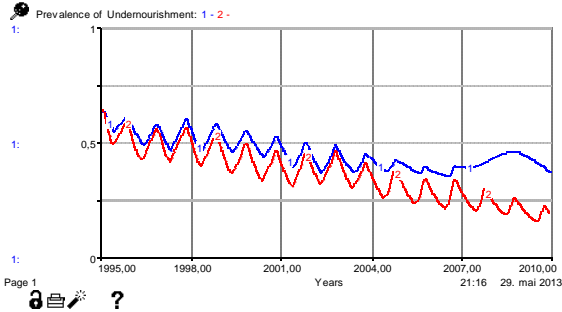

Figure 55(b): Prevalence of undernourishment

Figure 55: Simulation results of desired effective cereal consumption and prevalence of undernourishment with the extreme maximum test (cereal expenditure share = 1).

The simulation result, with the extreme maximum test of cereal expenditure share condition (cereal expenditure share = 1) shows the desired effective cereal consumption figure 55 (a) becomes well above from the base run (blue) meaning the increase in cereal expenditure share increases the purchasing power of the population. That is the population will have a high materialized desired consumption which causes the decrease in prevalence of undernourishment (figure 55 (b)) compared to the base run. Hence the prevalence of undernourishment has shown improvements (decrease) in the extreme maximum condition test.

Secondly, we check the extreme conditions of average rainfall. In the model, the average rainfall is assumed to have an effect on the yields of cereals. The optimum favorable average Meher (4-moth) rainfall for yield, at country level, ranges from 170-190 mm per month. This value should not be misinterpreted in that it is the average country level rainfall so that it is not a good indication for yield because this average can also represent extreme high rainfall in some areas and extreme drought in other areas which are harsh environmental conditions for cultivation. Moreover, it should not be used as a reference to a particular area of interest. But from our data analysis, we found this value to represent the range of optimal rainfall for yield.

Therefore, in our extreme value analysis we investigate the conditions arising when the average rainfall = 0 mm/month (extreme drought) and when it is considerably higher than the optimum average rain fall i.e. 1000 mm/month (extreme flood). Under these extreme conditions, we expect the yield and production of cereals to go to zero. The simulation results are shown in the figure 56 below.

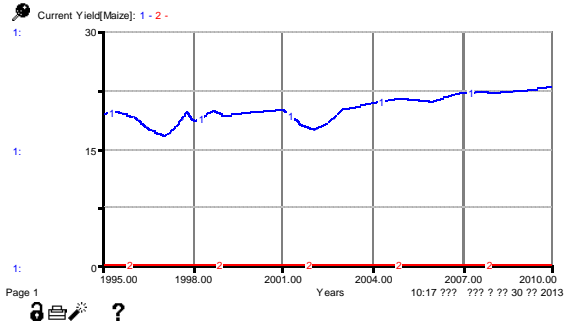

Figure 56 (a): Yield of maize

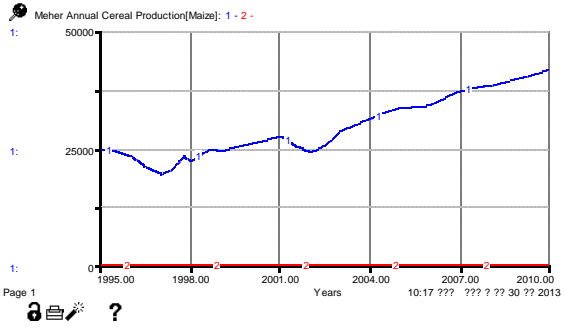

Figure 56 (b): Production of Maize

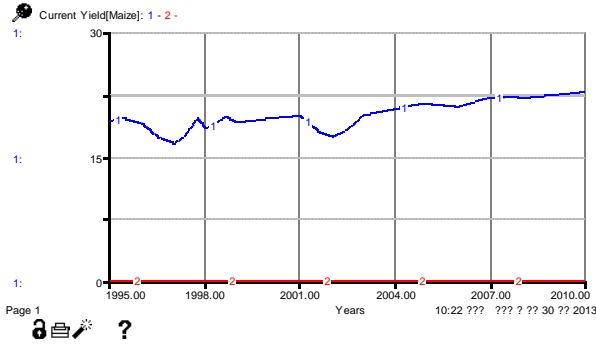

Figure 56 (c): Yield of maize

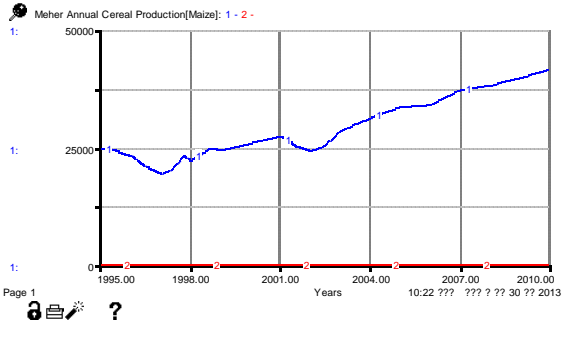

Figure 56 (d): Production of maize

Figure 56: Simulation results of cereal yield and production for the extreme tests average rainfall

As shown in the figure 56 (a) and (b) under the extreme minimum test of rainfall (average rainfall = 0 mm/month), the yield and production of cereal become zero (red color). Similarly, the yield and production of cereal with the extreme maximum test (average rainfall = 1000 mm/month) figure 56 (c) and (d) becomes zero (red simulation).

Average topsoil depth loss rate is the measure of the intensity (severity) of soil erosion by water. The higher the soil depth loss rate, the faster the land move through the various land suitable classes, resulting in a faster decline in soil fertility. The average top soil loss rate used in the model is 0.4 cm/year (Sonneveld B. G. J. S. et al. 2002, Zelleke, G. et al. 2010). The two extreme conditions could be (a), the average topsoil depth loss rate ~ 0 (0 cm/year) i.e. no top soil loss rate, and (b), the average topsoil depth loss rate = 1 cm/year (very fast top soil loss).

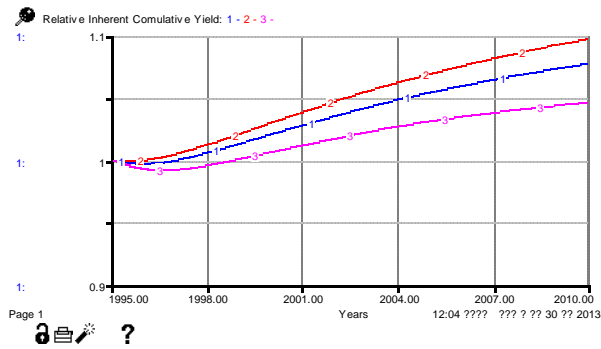

Figure 57 (a): Relative inherent yield

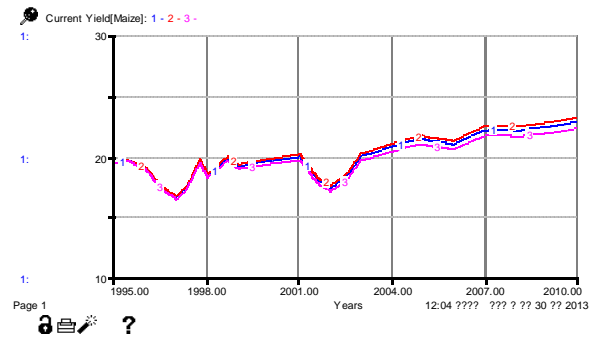

Figure 57 (b): Maize current yield

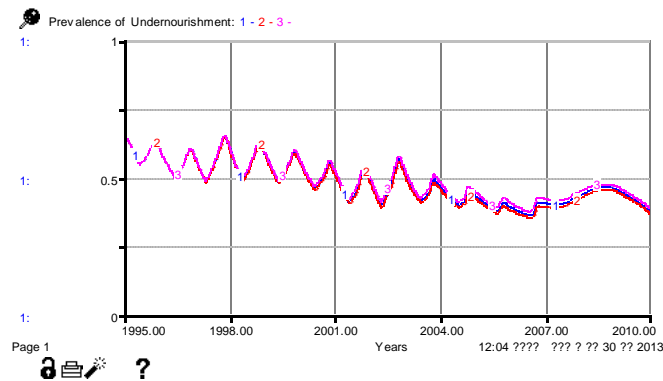

Figure 57 (c): Prevalence of undernourishment

Figure 57: Simulation results with the extreme condition test of topsoil loss rate (blue-base run, red-0 loss rate and pink- 1cm/year loss rate).

From figure 57 (a), simulation results show that relative inherent (red) yield is well above the base run when the topsoil loss rate is arrested (the average topsoil depth loss rate ~ 0) implies the fertility of the land has improved, and also in the extreme maximum condition (the average topsoil depth loss rate = 1) the graph of inherent yield is lower than the base run meaning the land has become less fertile. The other variables which are directly linked to the topsoil loss rate are the yield (current yield) and prevalence of under nourishment. The yields of cereal figure 57 (b), and the prevalence of undernourishment figure 57 (c) has also shown improvements (red simulation) when the topsoil loss rate is arrested (the average topsoil depth loss rate ~ 0). However, the yields of cereal figure 57 (b)-pink, and the prevalence of undernourishment figure 57 (c)-pink, become aggravated when the top soil loss rate is very high (the average topsoil depth loss rate = 1).

Note: In the above graph, the pattern of the simulation results for prevalence of undernourishment is different from the patterns of relative inherent yield and current yield. Prevalence of undernourishment improves when it has lower value than the base run.

The extreme test analysis shows that the topsoil loss rate was not significantly affecting the food security in the analysis time frame. Even in the extreme degradation case the effect is insignificant. But it should be noted that first, the degradation process is very slow to affect the yield within one and a half decades (it takes hundreds of years through which the land to be degraded and loose its fertility) and second, the current yield of cereals is mainly influenced by the proportion of land which exists in the various degradation stages that has resulted from hundreds of years of degradation, rather than the ongoing slow degradation process. In other words, it is the stocks of the land exist in the various degradation stages that determine the current yield. From our analysis and the distribution of land on these degradation stage presented in section 3.2.2.2 (Sonneved B.G.J.S., 2002), the productivity of the land would have been 20-25 % higher than the current productivity if all land exist on the high productive land stock (not degraded). Hence, there is a room for increasing productivity through the rehabilitation of the degraded land by around 20-25 % in the long run.

Finally, we test the extreme conditions targeting the share of cereal in a daily Kcal consumption. The share of cereal in a daily Kcal consumption could vary from 0 (no consumption at all) to 1 (only cereal consumption). We expect the simulation behavior of desired cereal consumption and prevalence of undernourishment to be lower (~0) than the base run when the Kcal share of cereal is 0. We expect that the desired cereal consumption and the prevalence of undernourishment will be higher than the base run when the Kcal share of cereal is 1. The simulated model behavior of prevalence of undernourishment is given below.

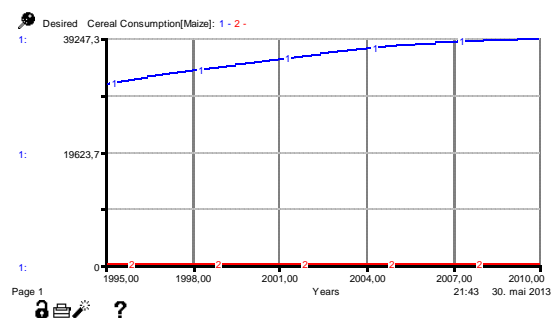

Figure 58 (a): Desired cereal consumption

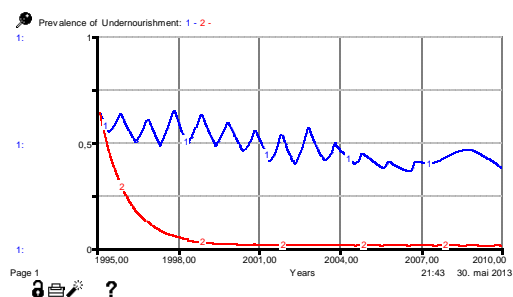

Figure 58 (b): Prevalence of undernourishment

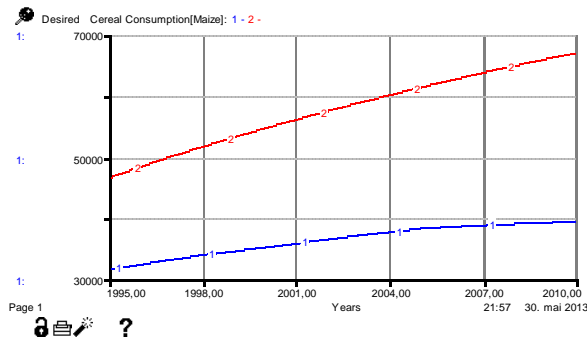

Figure 58 (c): Desired cereal consumption

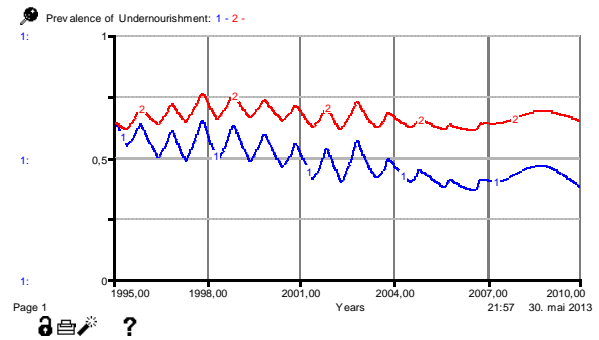

Figure 58 (d): Prevalence of undernourishment

Figure 58: Simulation results with the extreme conditions of Kcal share for cereals

As shown from the simulation results figure 38 (a), and (b), the desired cereal consumption and the prevalence of undernourishment has significantly decreased in the case when the cereal Kcal share close to zero (below the base run- blue). On the other hand, the simulation results of desired cereal consumption and prevalence of undernourishment, figure 38 (c) and (d), has shown significant increments as the Kcal share of cereal becomes 1 (above the base run- blue).

4.6 Sensitivity Analysis

In system dynamics, sensitivity analysis is made to check whether or not the model is sensitive to some parameters. Especially, sensitivity analysis is conducted, on parameter values that are estimated based on statistical data and expert knowledge, or parameter values resulting from other research. Besides examining how sensitive the model is to the parameter, the purpose of sensitivity analysis is also to examine whether the real system would exhibit similar sensitivity to the same parameter (Barlas, Y., 1994).

It is important to examine the sensitivity of our model structure to some of the variables in this study. At this stage it is important to explain the colors in the graph of our sensitivity analysis. We refer the simulation behavior of the parameter with the value replicating the reference behavior, red color (2) simulation graph, as the base run. The simulated behavior, with a 50 % of the parameter below or above the base run value, is represented by the blue (1) and the pink color (3) respectively, and the simulated behavior of the parameter, with 100 % (doubling the parameter) increase of the parameter, is represented by a green (4) curve. We used an incremental sensitivity analysis, and it implies that the confidence interval between two consecutive simulation behaviors of the parameter is 50 %.

Rehabilitation time is the duration required to change the non-productive land into potential arable land (section 3.2.2.2). As mentioned in the model description, the land rehabilitation time has causal relationship with the potential arable land and non-productive land. The higher the rehabilitation time causes to decrease the conversion rate of non-productive land into potential arable land. But the lower the rehabilitation time causes to increase the conversion rate of non-fertile land into potential arable land resulting in a decrease in the non-fertile land.

Figure 59 (a-d) shows the sensitivity analysis of non-productive land, potential arable land, cereal cultivation land, and prevalence of undernourishment with the change in land rehabilitation time.

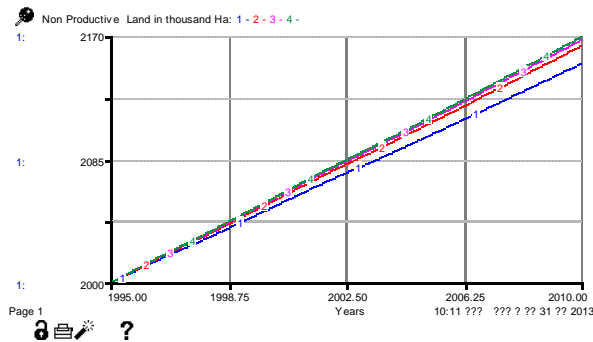

Figure 59 (a): Non-productive land

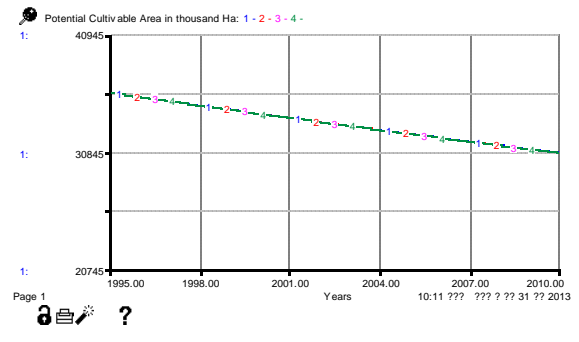

Figure 59 (b): Potential Arable Land

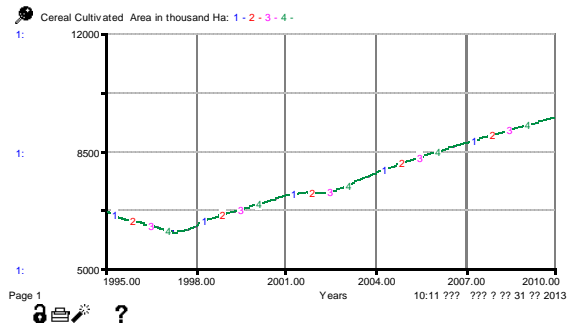

Figure 59 (c): Cereal Cultivation Land

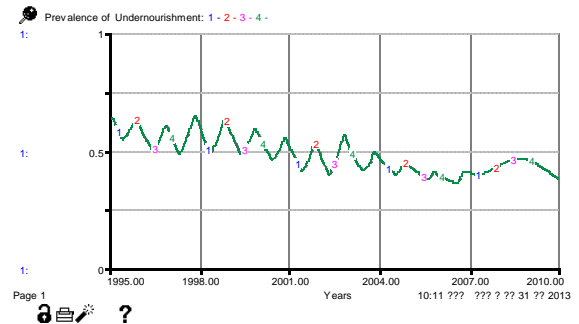

Figure 59 (c): Prevalence of undernourishment

Figure 59: The sensitivity analysis of non-productive land, potential arable land, cereal cultivation land, and prevalence of undernourishment with the land rehabilitation time.

The non-productive land figure 59 (a) is more sensitive than the other three parameters shown in the figure 59 (b), (c), and (d). The general model behavior is less sensitive to this parameter implies that the model is robust with this parameter.

Now let us examine the sensitivity of the model with the markup fraction, we explained the markup fraction as the percentage of retailer price at which retailers’ make profit or it is the profit margin of retailers while they are merchandizing cereals. The increase in markup fraction cause the increase in the retailer price, which decreases the desired effective cereal consumption subsequently causes to increases the prevalence of undernourishment.

Figure 60 shows the sensitivity analysis of retailer price of maize, desired effective maize consumption, and prevalence of undernourishment with the flexibility of markup fraction (we choose one of the cereal types, Maize, for simplicity but the behavior is the same for other cereals).

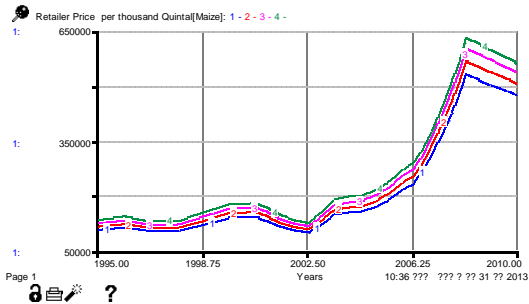

Figure 60 (a): Maize retailer price

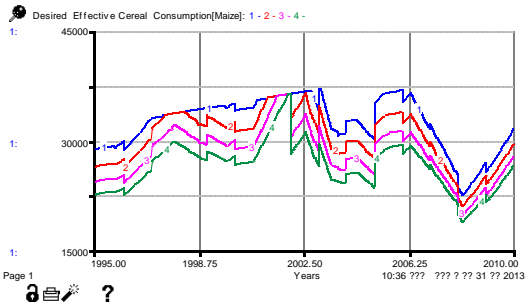

Figure 60 (b): Maize desired effective consumption

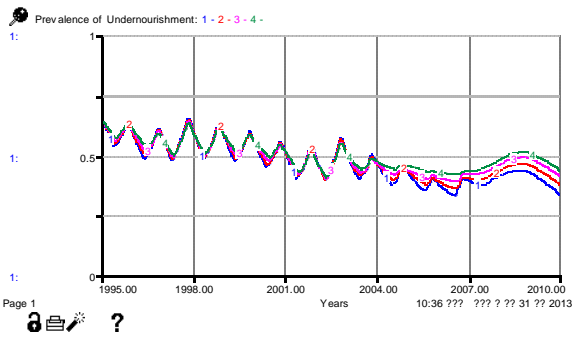

Figure 60 (c): Prevalence of undernourishment

Figure 60: Sensitivity analysis with the elasticity of markup fraction.

As shown in the figure 60 above, while the retailer price increases the desired effective cereal consumption decreases resulting in the increase in the prevalence of undernourishment.

Meaning the price increase in the price causes to decrease the purchasing power of the population especially on those years where the purchasing power was a constrained (2005-2010).

The third sensitivity analysis is for the fallowing fraction, in section 3.2.2.2 we have explained that some (small) percentage of the cereal cultivation area has been temporary fallowed for the purpose of maintaining the productivity of the land. We wanted to examine the sensitivity of the variables: Fallow land, cereal cultivation land, and the prevalence of undernourishment with the change in the fallowing fraction. There is causal relationship (the higher the fallowing fraction causes to increase the fallow land) among the variables; the fallowing fraction, cereal cultivation area, and the fallow land (the higher the fallowing fraction causes to decrease the cereal cultivation land). And the graph of prevalence of undernourishment is higher than the base run when the fallowing fraction is high.

Figure 61 shows the sensitivity analysis of fallow land, cereal cultivation area, and prevalence of undernourishment with the change in fallowing fraction.

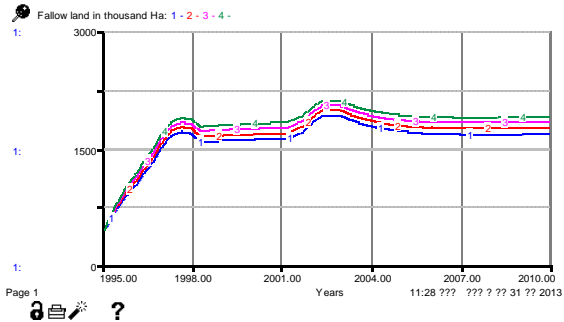

Figure 61(a): Fallow land

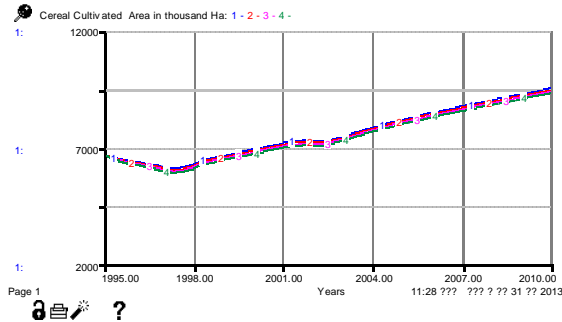

Figure 61(b): Cereal cultivation land

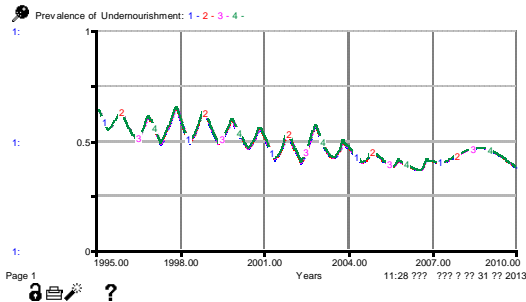

Figure 61(c): Prevalence of undernourishment

Figure 61: The sensitivity analysis with the change in fallowing fraction.

From the above sensitivity analysis the general model behavior is less sensitive to these parameters implies that the model is robust with these parameters. Sensitivity analysis for the top soil loss rate is presented in the appendix A.

4.7 Behavior Analysis

4.7.1 Behavior Analysis of Cereal Consumption and Access

In this section, our main concern is to describe the behavioral interaction of the various variables resulting in the existing behavior of undernourishment. In doing this, we use the simulation results of variables linked in a loop, to describe the resulting behavior of the reference behavior.

We choose to start the behavioral analysis from the population sector. In this part our explanation includes the behavioral analysis of desired cereal consumption and actual consumption of cereals which ultimately result in the prevalence of undernourishment (loops, R1, R2 and R3).

The gradual decrement of total fertility rate starting from around 7 to 4 babies per woman and gradual increment of life expectancy from around 50 to 60 years, together with the relatively constant fraction of death, and net migration has resulted in the increase of the total population. The total population increases with a decreasing rate.

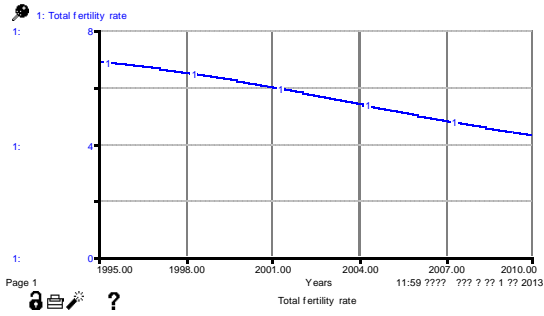

Figure 62 (a): Total fertility rate

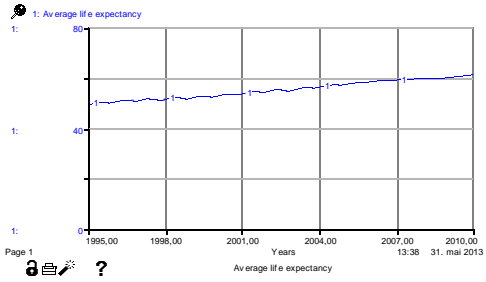

Figure 62: Total population

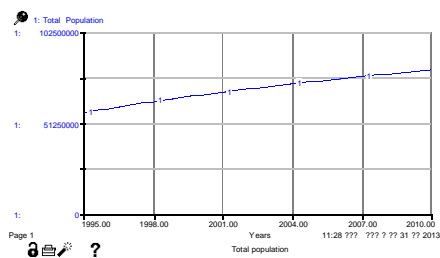

Figure 62 (c): Total fertility

Figure 62: Causes of population growth

The gradual decrease in total fertility rate has resulted in a gradual decrease in growth rate of the aging chains. Whereas, the child cohort is sensitive to the change total fertility rate as it has short delay time (five year delay), the fertile age population cohort has been relatively insensitive with the gradual decrement of the total fertility rate since it has long delay (35 years).

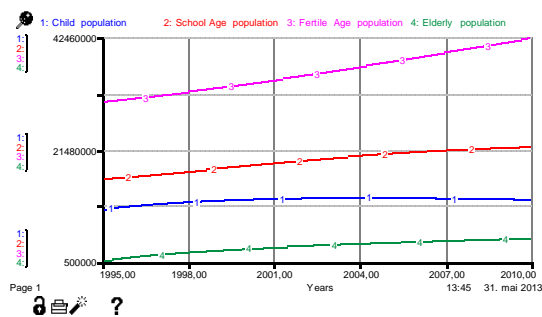

Figure 63 (a): Population age cohort.

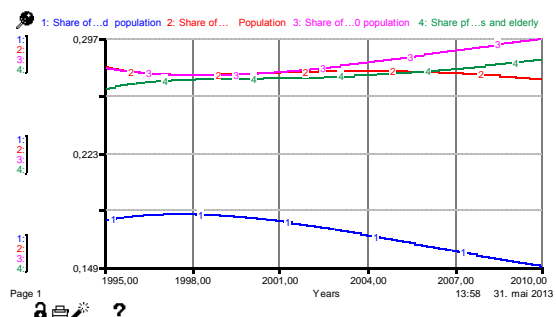

Figure 63(b): Fraction of population age cohorts.

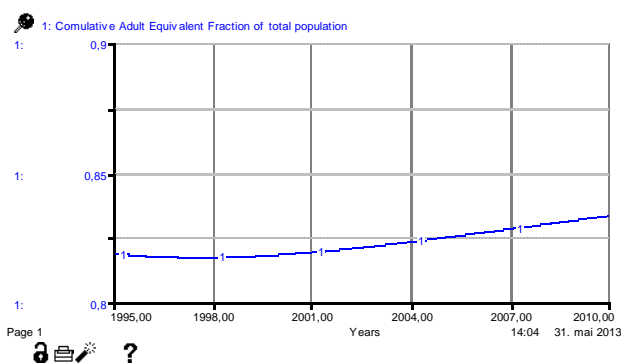

Figure 63 (c): Adult-equivalent calorie consumption of the total population.

Figure 63: The change in demography and adult-equivalent calorie consumption.

The change in population size in the age cohorts shown above has resulted in the relative change of percentage of the cohorts forming the total population. After a decreasing

rate increase in share of the child cohort, the child cohort gradually loses its share from the total population. This is mainly because, not only the child cohort size is decreasing but also the fertile age and elderly population size is increasing faster from 2004 onwards. The percentage of the school age cohort also experienced a decrease in percentage after nearly five years the child cohort does.

The relative change in percentage of the age cohorts forming the total population figure 63 (b) has resulted in the increase in adult equivalent fraction of the total population. That is, due to slight demographic changes the energy requirement of the population has shown slight increase. The amount of cumulative adult equivalent fraction also implies that the calorie requirement of the average person is well below an adult requirement (1) figure 63 (c).

Even if the cumulative adult equivalent fraction increases, the daily desired net Kcal per-capita consumption from cereals decreases as shown in figure 64 (c) below. It is because the calorie share of cereals from the daily consumption has gradually decreased as shown in the figure 64 (b) below.

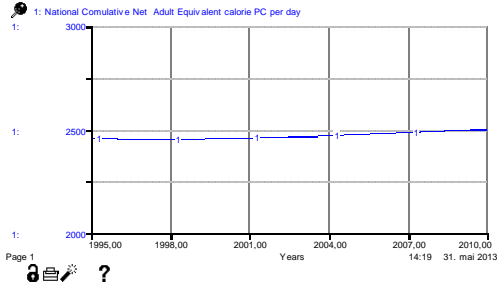

Figure 64 (a): Daily net per-capita Kcal requirement

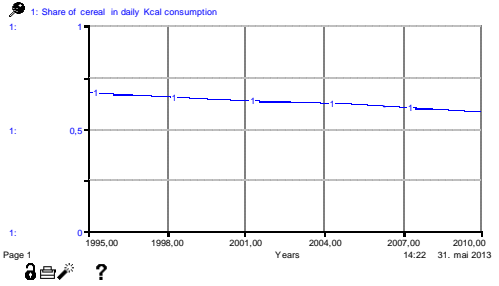

Figure 64 (b): Share of cereals in a daily Kcal consumption

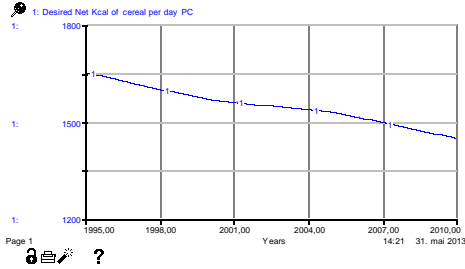

Figure 64 (c): Daily net per-capita Kcal requirement from cereal

Figure 64: The effect of change in adult-equivalent calorie consumption, and the calorie share of cereals on the daily calorie consumption

Similarly, although the daily desired net Kcal consumption per-capita shows a decrease in trend as shown in figure 64 (c) above, the cumulative annual desired cereal consumption has increased with a decreasing trend in the last one and half decades. The reason is literally because; the cumulative annual demand is a result of the multiplication of the total population.

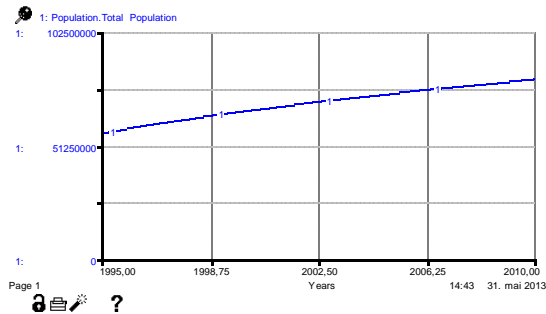

Figure 65 (a): Total population

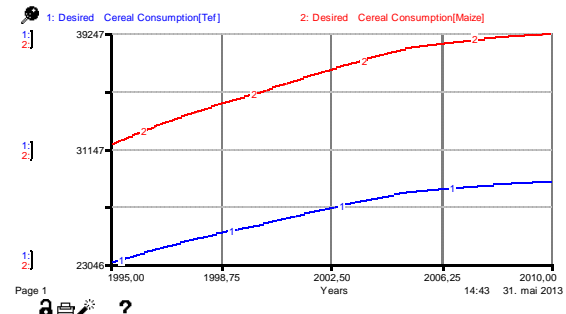

Figure 65 (b): Annual desired cereal consumption tef (blue) and maize (red)

Figure 65: desired cereal consumption (Annual)

So far, we have seen the model simulated behavioral interaction of the various variables resulting in the annual desired cereal consumption of the population. Now let us pause this part at this stage and continue our behavioral analysis for economic and physical access of cereals for the population. The behavior analysis for economic and physical access of cereals, together with the desired cereal consumption enables us to examine the behavior of the actual cereal consumption, which results in the behavior of prevalence of undernourishment.

The annual per-capita expenditure multiplied with the share of cereal expenditure shown below in figure 66 (a) and (c), resulted in the annual per capita budget for cereal consumption figure 66 (c).

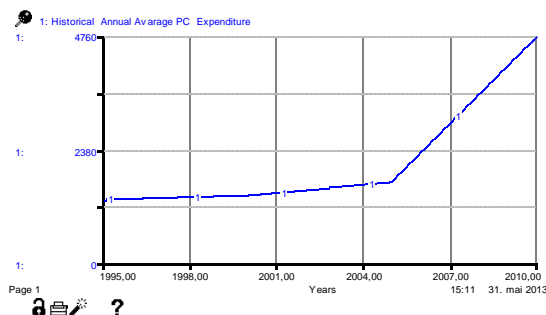

Figure 66 (a): Historical annual per capita expenditure

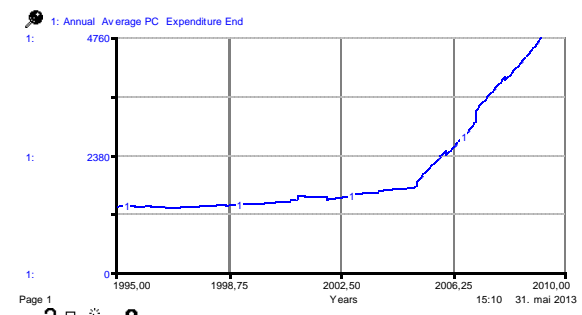

Figure 66 (b): Endogenous annual PC expenditure

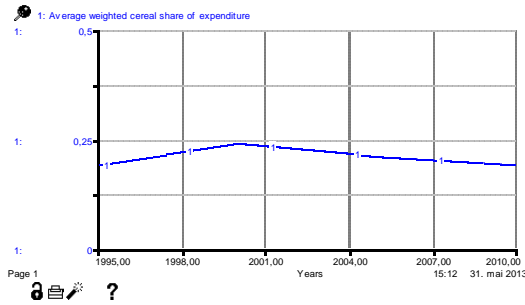

Figure 66 (c): Expenditure share of cereals

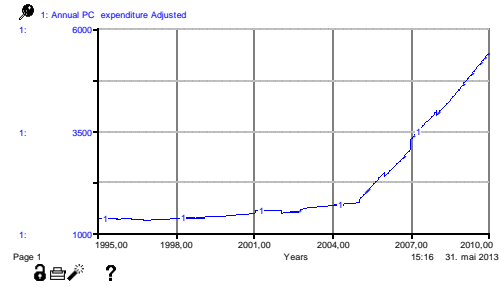

Figure 66 (d): Annual PC cereal budget

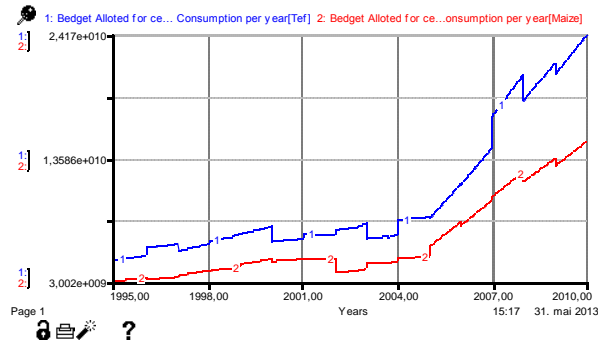

Figure 66 (e): Annual total cereal budget of the population, tef (blue), maize (red)

Figure 66: The simulation behavior of total annual budget of cereal and its inputs.

The annual per-capita expenditure End figure 66 (b), is the 25 % internalization of the historical annual per-capita expenditure figure 66 (a). Hence only 25 % change of the per-capita expenditure is explained by the model behavior. The multiplication of the annual per-capita expenditure with the total population resulted in the annual total cereal budget of the population, figure 66 (e).

Now let us consider the interaction of the annual total cereal budget and the retailer price to examine the desired effective cereal consumption of the population. It should be noted that the desired effective cereal consumption is the desired cereal consumption of the population materialized with the purchasing power of the population (it shows the economic power of the population in accessing the desired cereal consumption).

As shown in the figure below, the retailer price of most cereals have the same trend. In general, for most cereals, the price was relatively oscillatory from 1995 to 2003. It reaches its local minimum in 1997 and 2003, and local maximum in 2000. After 2003, the price increases exponentially to reach its absolute maximum in 2009, followed by some decline in 2010. We will examine the behavior of the retailer price while we study other loops.



Figure 67: Retailer price of cereals

Now let us analyze the behavior of the desired purchased cereal consumption, from 1995 to 2005, it is noticed that the local maximum and local minimum values of the desired purchased cereal consumption coincides the local minimum and local maximum of the retailer cereal price respectively. Hence, desired purchased cereal oscillates in this period because of the oscillation of the price, and the cereal budget was relatively constant. However, the explanation of desired purchased cereal consumption differs in the remaining years. The annual cereal budget has increased significantly in the last five simulation years; as well the price of cereals also increases in those years. But the increase in cereal budget was relatively higher than the increase in price from 2005 to 2007 which result in an increase amount of desired purchased cereals. Similarly, even if the cereal budget was increasing from 2007 to 2008, the increase in price was higher than the increase in budget, thus the desired purchased cereals almost decreases in these two years. Finally, the desired purchase cereal tends to increase afterwards.

Note: the irregularity on the graph of desired purchased cereal is a result of the irregularity in expenditure shares of cereal not from other exogenous variable.

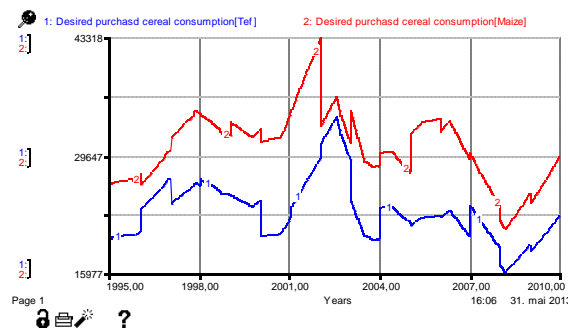

Figure 68: Desired purchased cereal.

Now we can compare the desired cereal consumption (the one pause above) and the desired purchased cereal consumption. The minimum of the desired cereal consumption and the desired purchased cereal consumption results in the desired effective cereal consumption (materializes desired cereal consumption mainly with the purchasing power). Taking the minimum of the behavior of desired cereal consumption figure 65 (b) and desired purchased cereal figure 48 we have the behavior of desired effective cereal consumption, figure 69 below.

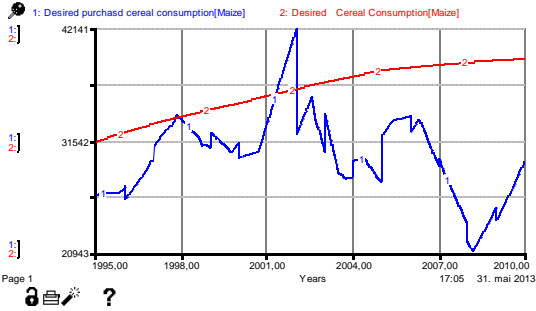

Figure 69 (a): Desired cereal consumption and desired purchased cereal consumption

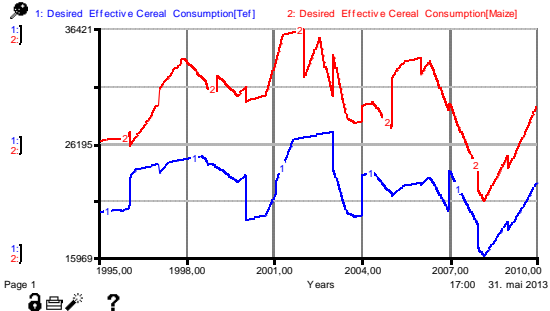

Figure 69 (b): Desired effective cereal consumption

Figure 69: Economic constrained of desired effective cereal consumption

Thus, the above figure 69 (a) implies that the purchasing power has been one of the constrained to consume the desired cereal consumption (economic constrained) except in 2001. On the other hand, let us examine the behavior of desired effective cereal consumption and the consumption shipment.

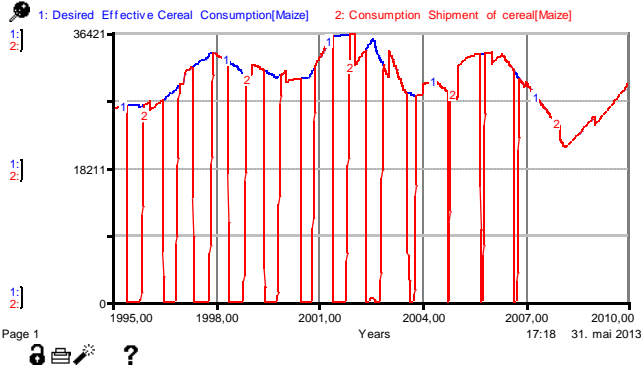

Figure 70: Comparison of desired effective cereal consumption (blue) and the consumption shipment (red)

The graph above signifies that even with the existence of purchasing power, all desired effective cereal consumption were not satisfied due to the limited supply of cereals from the market. Hence this signifies the availability of food / cereals is the main constrained for food security.

The gap between the desired cereal consumption and the actual cereal consumption is the main cause of undernourishment. Figure 71 shows the behavior of the number of population desired to be nourished (total population) and the number of population effectively nourished.

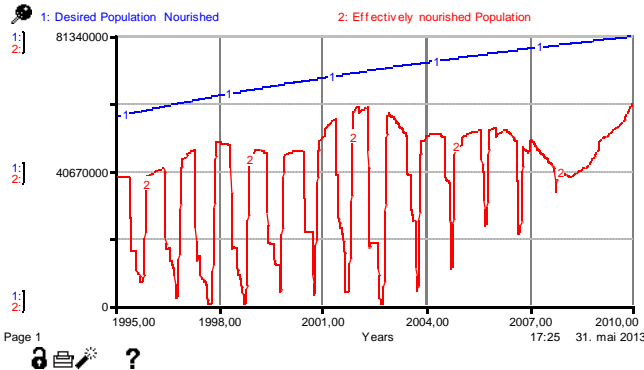

Figure 71: The behavior of the number of population desired to be nourished (blue) and the number of population effectively nourished (red).

Hence, the behavior of prevalence of undernourishment is an oscillation (we will explain the causes of oscillation in the next section) shown is the figure 72, averaged by the red curve. The oscillations shown from 1995 to 2007 arise from the insufficient supply (shipment) of cereals from the market. While the relatively smooth part of the undernourishment curve shown from 2008 to 2010 arise from the constrained of purchasing power as the price has exaggerated.

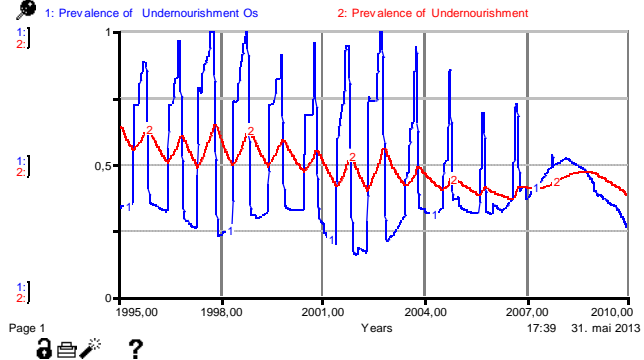

Figure 72 (a): Prevalence of undernourishment averaged (red), and instantaneous (red)

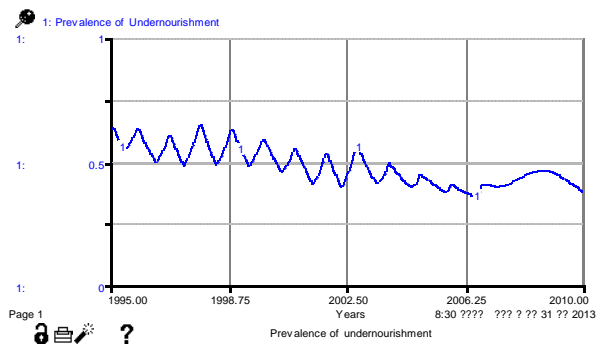

Figure 72 (b): Prevalence of undernourishment

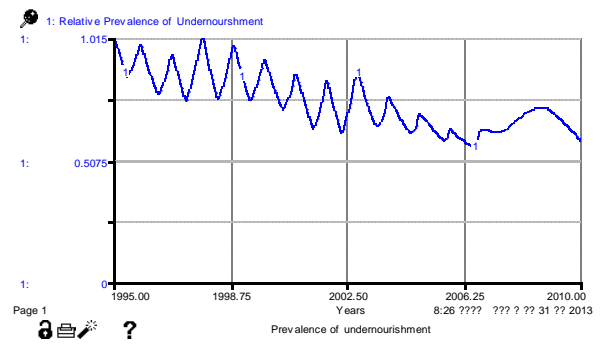

Figure 72 (c): Relative prevalence of undernourishment

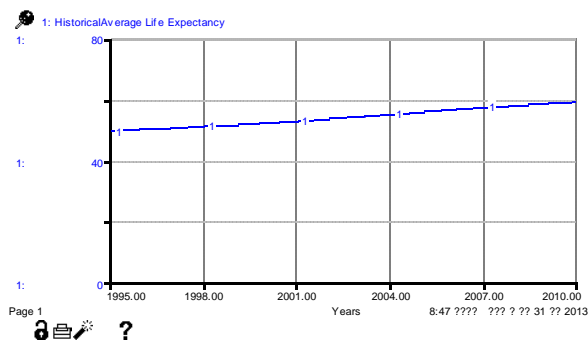

Figure 72 (d): Life expectancy

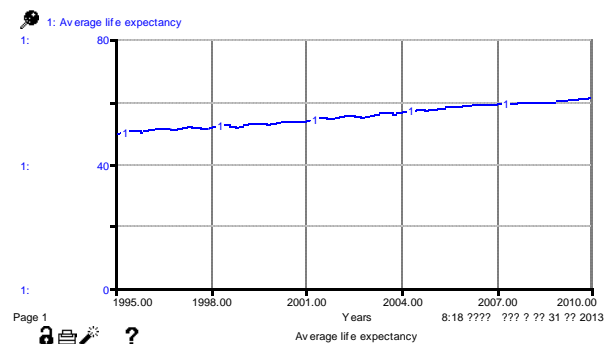

Figure 72 (e): Life expectancy

Figure 72: Life expectancy and prevalence of undernourishment.

The decline in prevalence of undernourishment throughout the simulation figure 72 (a) results in a decline in the relative prevalence of undernourishment figure 72 (b). However, a change in the prevalence of undernourishment only causes around 8 % change in death fraction and 9 % change in life expectancy (Gebremariam, A.et al., 2005, p. 131-164) this closes the four loops B1, R1,R2, and R3.

4.7.2 Behavioral Analysis of Cereal Production and Market

In our previous behavioral analysis we used the behavior of *consumption shipment*, *annual average expenditure*, and *retailer cereal price* for the behavioral analysis of *prevalence of undernourishment*. But we did not explain how the behavior of each variable had generated. Thus, in this section we try to examine the behaviors of some variables in model which contributed to the behavior of these variables (land use, land fertility and market) in the loops B4, B8, R4, and, R5.

In figure 62 (a), we have seen that the population is increasing with a decreasing rate; it has resulted in same trend on the desired land for cultivation shown below in the figure 73 (as the desired area for cultivation is a product of total population and the per capita desired cultivation area).

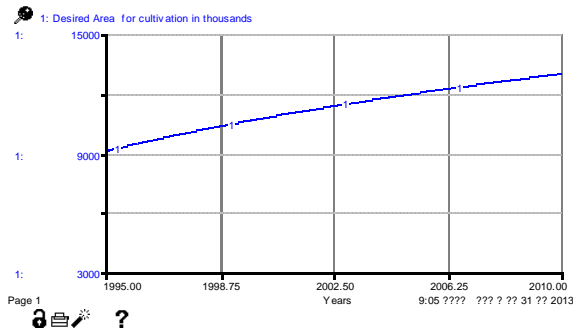

Figure 73 (a): Desired cultivation land

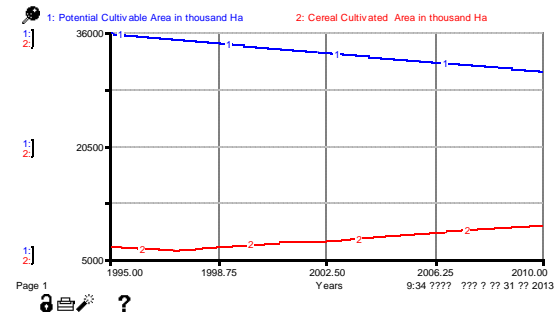

Figure 73(b): Cereal cultivation land and potential arable land

Figure 73: Desired cultivation land, cultivation land and potential cultivation land.

The continuously increase in desired cultivation area has two major effects on the use of land (cultivation land and potential cultivation land). The cereal cultivation land, figure 73 (b) -blue curve has shown a continuous increase while the potential cultivation area, figure 73 (b)-red curve, shows a continuous decrease over all the simulation time.

On the other hand, the yield of almost all cereals has shown a relatively stagnant growth accompanied with a major drop 1996/7 and 2001/2 (due to exogenous rainfall). And then the yield of cereals increases after wards from 2003 approximately linearly. We will discuss the causes of the behavioral changes of the yield in latter sections. Figure 74 shows the simulation behavior of the yields (in quintal per hectare) of main cereals.

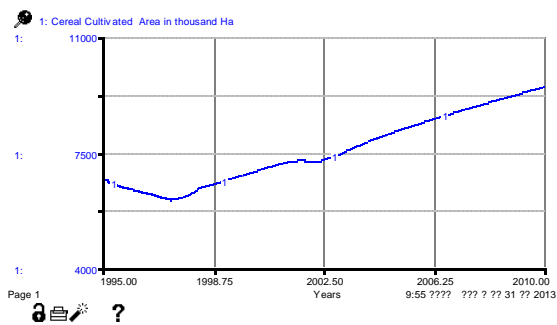

Figure 74(a): Cereal cultivation land

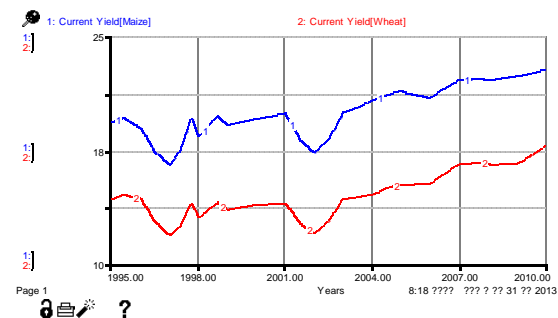

Figure 74(b): Yields of maize (blue) and wheat (red)

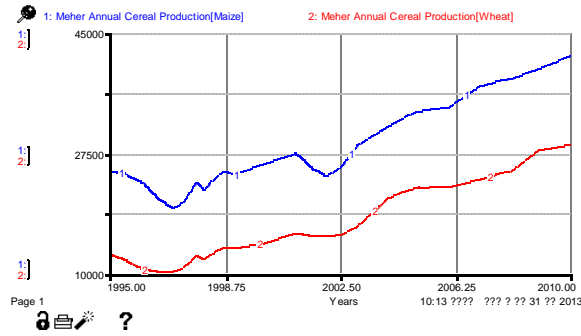

Figure 74 (c): Production of maize (blue), and wheat (red)

Figure 74: The behavioral interaction of cultivation area, and yield resulting production

The combined behavior of cereal cultivation land and the cereal yield, both are relatively stagnant in the first six years of simulation with a drop in size 1996/7 and 2001/2, and both progressively increase after 2002, results in the simulation behavior of annual cereal production. The drop in production in 1996/7 and 2001/2 is mainly attributed to the drop in yield.

Note: the cultivation area share of each cereal differs from the other (tef has the largest cultivation area share).

The delivery of cereals to the market has been seasonal and the distribution of the annual Meher production in to Meher harvest seasons results in the seasonal delivery of Meher production. Figure 75 shows the seasonality multiplier (a) and seasonal delivery of Meher production (b). It can be noticed from the graph that the amplitude of oscillation gets its local maximum and minimum on the maximum and minimum production seasons.

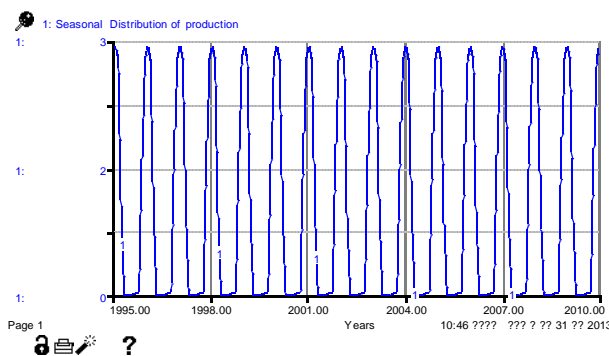

Figure 75 (a): Seasonality distribution

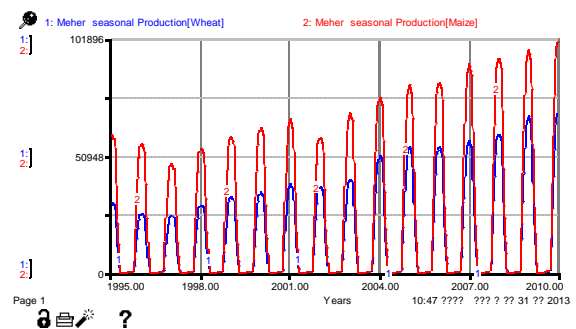

Figure 75 (b): Meher seasonality delivery wheat (blue), and maize (red)

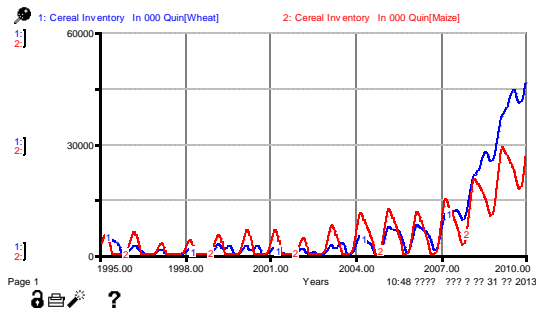

Figure 75 (c): Inventory wheat (blue), and maize (red)

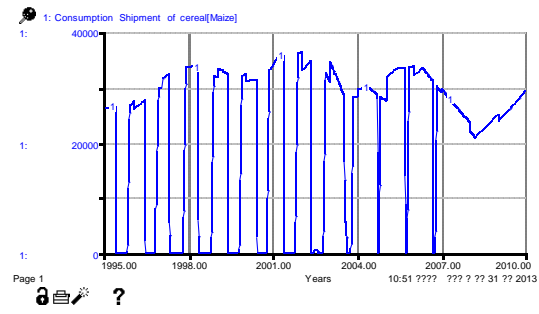

Figure 75 (d): Maize shipment for consumption

Figure 75: Behavioral interaction of meher production delivery, inventory, and shipment for consumption

Even though there are deliveries other than the Meher cereal delivery to the market (like Belg and import deliveries), their share has been very small and their influence in increasing the inventory limited. Figure 75 (c) shows the simulated behavior of cereal inventory for wheat and maize. The behavior of cereal inventory is highly influenced by the Meher delivery and the inventory accumulates soon after the arrival of Meher production. However, the cereal inventory drains in the Belg season (from 1995-2008) since there was no sufficient supply of cereals in the Belg season. In these years (from 1995-2008) the need for consumption shipments was higher than the market supplies (desired effective cereal consumption > shipment for consumption) hence resulted in the oscillatory behavior of the shipment for consumption figure 75 (d). But for the last two years (2009 and 2010), the market supply was higher than the consumption demand as a result the inventory gets to accumulate to a higher size.

It is a direct result that when there is no cereal in the market there would not be shipments for consumption. It is shown in the behavior of the consumption shipments of cereals, the shipments for consumption drops immediately when there is no sufficient amount of cereals in the inventory. In the simulated behavior shown in figure 75 (d), from 1995-2008, there was a huge drop in the consumption shipment of Maize from the market. And these drops of shipments are shown in the Belg season where the Meher production is running out of inventory. Thus, this answers one of the objectives raised at the beginning of this section (explaining the oscillatory behavior of cereal shipments closing loop R3).

On the other hand, the oscillatory behavior of the inventory resulted in an oscillatory behavior of the inventory ratio. Figure 76 (b), shows the simulated behavior of inventory ratio.

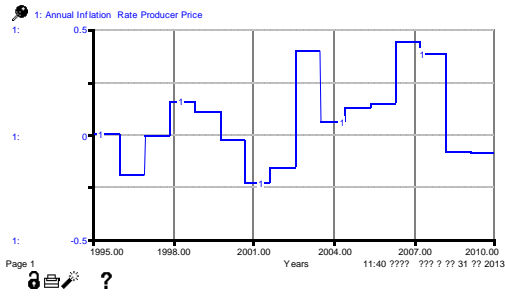

Figure 76 (a): Producer price inflation rate

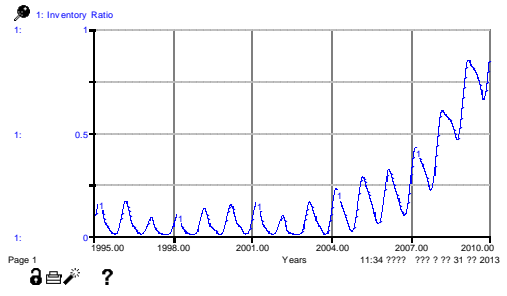

Figure 76 (b): Inventory ratio

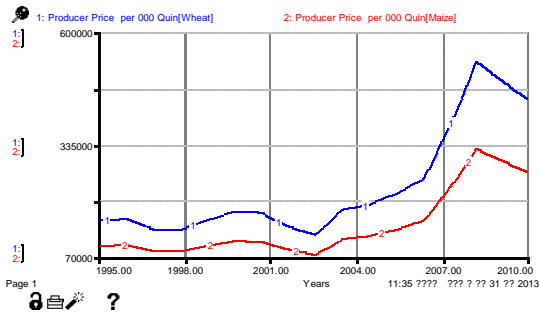

Figure 76(c): Producer Price wheat-blue and maize -red

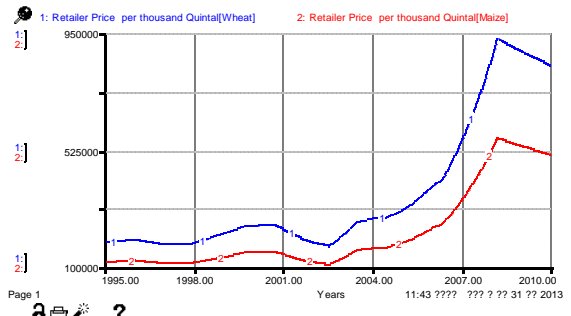

Figure 76 (d): Retailer Price wheat-blue and maize- red

Figure 76: The behavioral interaction of inflation rate, and inventory ratio determining price

However the producer price is less sensitive to the inventory ratio, rather it is highly sensitive to annual producer price inflation rate. Figure 76 (c) and 76 (d) shows the producer and retailer price of cereals respectively. This closes loop B8 and R5.

Now, it remains to analyze the simulation behavior of cereal yields (loops B4 and R4). In figure 74 (b), we have used the simulation behavior of cereal yield for explaining the behavior of cereal production. To explain the simulation behavior of cereal yield, it is better to start with the producer price and the cereal shipments, these define revenues for farmers. Figure 76 (c) above and figure 77 (a) below shows the simulated behavior of producer price and shipments for sell.

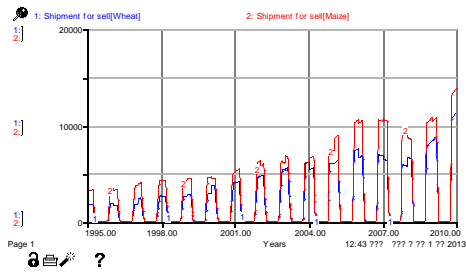

Figure 77 (a): Shipment for sell wheat (blue), and maize (red)

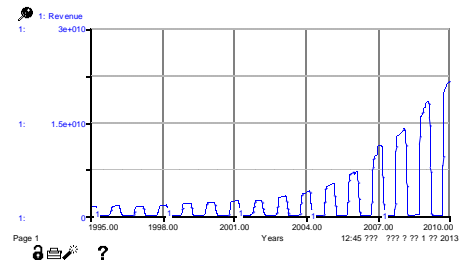

Figure 77 (b): Revenue

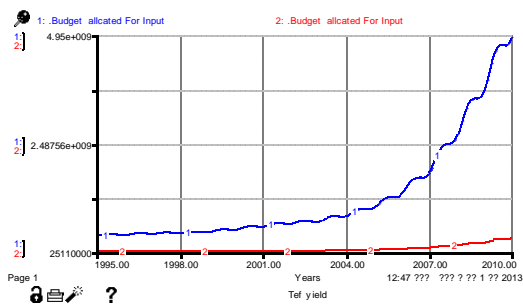

Figure 77 (c): Investment for input fertilizer (blue), improved seed (red)

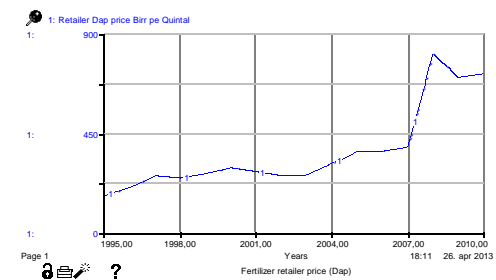

Figure 77 (d): Dap retailer price

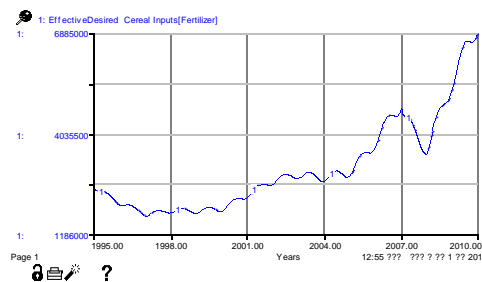

Figure 77 (e): Desired purchase input fertilizer (blue), improved seed (red)

Figure 77: Revenues of production and investment for production

We have described the simulated behavior of consumption shipments before in figure 75-maize, and shipment of cereal for sell has the same behavior with the shipment for consumption. The increase combined behavior of producer price and shipment of cereal sells resulted in the increase in behavior of revenues. Figure 77 (b) shows the simulated behavior of revenues obtained from sell in local currency (Birr). The increase in amplitude of revenue is contributed both from the behavior of producer price and sell. The budget for purchasing input (investment for input), figure 77 (c) resulted from revenues, has also progressively increased over the simulation time. The input price figure 77 (d) together with the budget for

purchasing input has resulted in the desired purchased input (fertilizer and improved seed) figure 77 (e). Subsequently, the desired purchased input constrained by the availability of input has resulted in the increase in inputs applied for production which has increased the coverage of inputs shown in the figure 78 below.

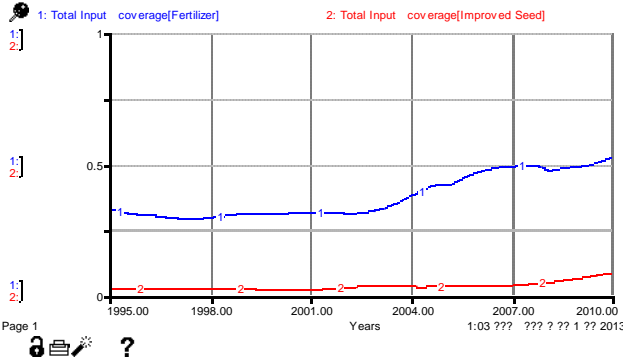

Figure 78: Coverage of fertilizer and improved seed

On the other hand, from the various land degradation series, the shares of the lands namely: productive land, suitable land, moderately suitable land, marginally suitable land, and non-suitable land has been changing affecting the cumulative inherent / potential yield. Figure 79 (a) shows the share of this land in the degradation process.



Figure 79 (a): Shares of productive (blue), suitable (red), moderately suitable (pink), marginally suitable (green), and non-suitable (pale)

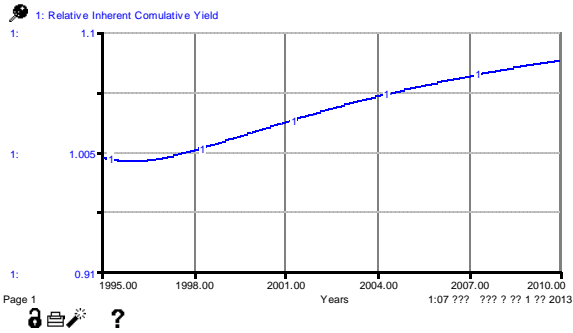

Figure 79 (b): Relative inherent / potential yield

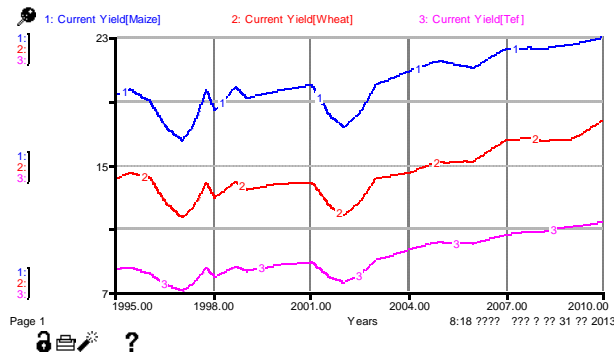

Figure 79 (c): Yield of maize (blue), wheat (red), and tef (pink)

Figure 79: Inherent / potential yield and current yield

Hence, as the share of high productive land increases, figure 79 (a blue), -land being adopted for cultivation from the potential arable land, the relative inherent cumulative yield has increased continuously well above one, figure 79 (b), The combined behavioral effect of relative inherent yield, input coverage figure 78, (both endogenous) has resulted in the increasing trend of yield. Thus this closes the loops B4 and R4.

Finally, it remains to explain the interaction of yield and per-capita expenditure. A 25 % change in per-capita expenditure can be explained by a relative change in yield. Increasing yield increases consumption to farmers and hence implies increase in per-capita cereal expenditure.

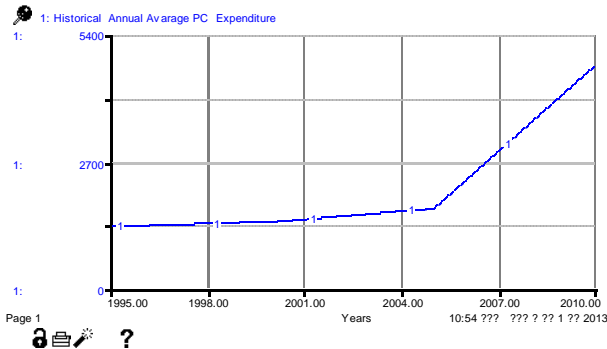

Figure 80 (a): Historical annual per-capita expenditure

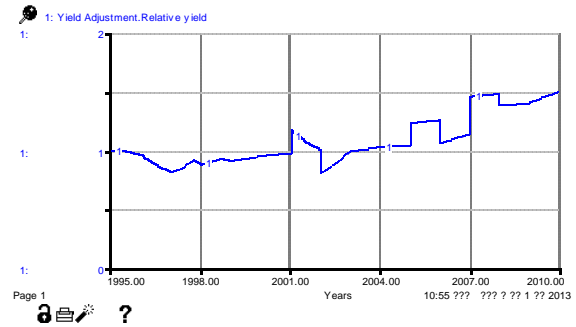

Figure 80 (b): Relative Current yield

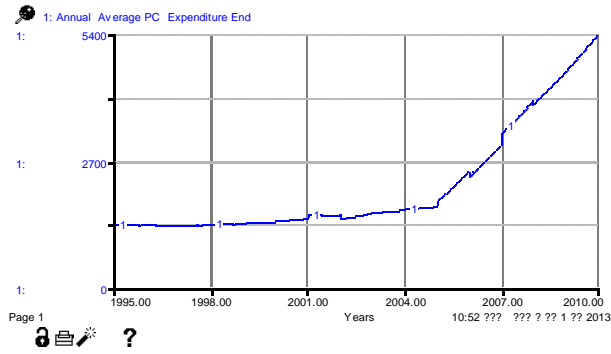

Figure 80 (c): Annual per-capita expenditure end.

Figure 80: Relative yield and per-capita expenditure

The yield and the per-capita expenditure were relatively constant in the first ten years of simulation, while, the approximately a linear increase is experienced in the last five years of simulation. This closes loop B9 and this section.

Chapter Five: Policy Analysis

In this chapter we will mainly focus on examining future policy options, and analyzing scenarios on selected variables. Increasing food / cereal production and natural resource management are of primary priority in the attempt to maintain sustainable food supply for the population. However, scenario analysis of expenditure (as a proxy for income), and environmental conditions (rainfall variability) are also analyzed for future possible developments of the food insecurity problem.

Three policy options; Land conservation / rehabilitation, agricultural input supply capacity building, and land management are the main future policy options we will examine in this study. The causal loop structure of the new policy model is presented in the figure below together with the causal loop structure of the explanatory model.

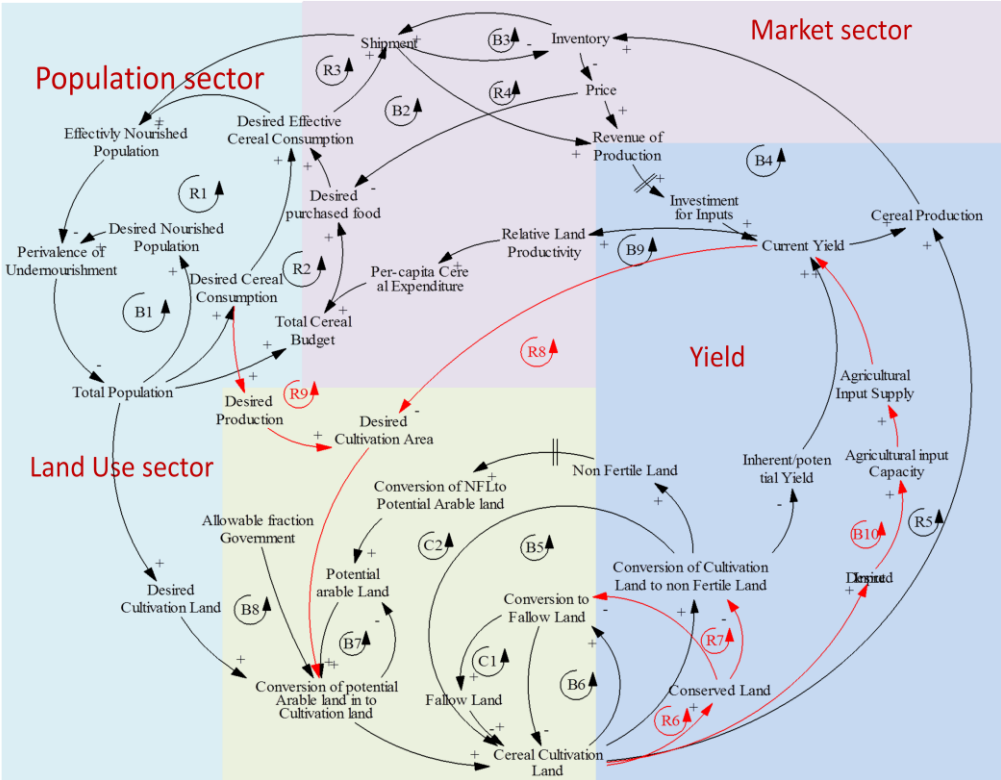

Figure 81: Main causal loop structure of the explanatory model (in black or brown color) and the new policy model (in blue color).

5.1 Land Conservation and/ or Land Rehabilitation

One of the main challenges or threats of food insecurity which has existed in the last decades and will prevail in the future is the poor management of natural resources. Soil degradation, the washing away of topsoil from cultivation land, needs to be stopped to increase the productivity of the land as well as to keep the land in use for generations. In the model explanation (section 3.2.2.2) we have examined the various stages of degradation or agricultural suitability classes that have resulted in the decline of soil fertility. Land degradation is a very slow process that takes hundreds of years to change a productive land into a non-productive land. However, the degraded land has contributed to the low average productivity of the land. The degraded land has accounted an estimate of around 20 % decline in the average yield.

The main objective of this policy option is to stop the soil erosion and ultimately rehabilitate the degraded land so that the productivity improves in the long run. Soil conservation techniques / methods generally include; soil and water conservation, construction of terraces, construction of check dams, cut-drains and micro-basin, afforestation and re-vegetation of fragile and hillside areas.

Various methodologies or practices has been applied to stop soil erosion depending on the topology of the land, the weather condition, the particular practices and experiences of the farmers, the accessibility of raw materials or technology, and, most importantly, the expert knowledge. In in some areas Ethiopia, a number of soil conservation / rehabilitation practices have been carried out for a number of decades. For example, stone terraces and checkdams in DewaChefa (Amhara), countour stone bund in Ederta (Tigray), grand soil bunds and relay cutoff drains in Hossana (SNNPR), stone bunds in North Shewa, stone faced soil bunds in Harerghie, vegetated stone-soil-stone bund in North Wello, konso bench terrace in Konso etc. (MARD, 2010).

The application of a particular soil conservation method, or a combination of them, could be decided on, based up on expert knowledge, land topology etc. Moreover, these technologies have stopped the loss of topsoil caused by water by reducing slope angle, reducing slope length, increase infiltration, maintaining water stored in the soil and sediment harvesting etc. (MARD, 2010) .

It is not the objective of this section to examine each of the various soil conservation methods. Rather it is (a) to examine the potential effect of the various soil conservation methods when applied in any combination to combat the soil degradation in Ethiopia as well as (b) to analyze the potential fertility and production development, and final (c) to examine its effect in alleviating food security. In the policy model, we considered one of the soil conservation methods for the purpose of simplicity.

5.1.1 Model Structure of the Soil Conservation / Rehabilitation Policy

The basic assumption in this policy option is that the applications of soil conservation methods gradually stop the topsoil loss from the land and that the land starts to gain topsoil through the natural decaying or sedimentation process, and consequently, become productive land after a long time of regeneration. We also claim that proper soil conservation and rehabilitation methods have effects that it improves the fertility of the soil in the long run. As a result, effects of soil conservation will decrease the fallowing fraction of the land which, ultimately, increases the cultivation land by preventing it from degrading to fallow land.

5.1.2 Causal Loop Structure

In the figure 81 above, the loops R6 and R7 represent the new soil conservation / rehabilitation policy structure. The reinforcing loop R6 represents the effect of the conserved cultivation land in reducing the cultivation land from being fallowed (temporarily). The increase in the cultivation land causes an increase in the need for conserved land and then the increase in conserved land decreases the conversion rate of cultivation land into fallow land which subsequently causes an increase in the cultivation land below what it would otherwise have been. Similarly, in the reinforcing loop R7 the effect of conserved cultivation land reduces the land from being non-fertile. The increase in cereal cultivation land increases the need for conserved land which causes a decrease in the conversion of cultivation land into non-fertile land. Subsequently the decrease in conversion of cultivation land over time increases the cereal cultivation land below what it would otherwise have been, this closes the loop.

5.1.3 Stock and Flow Structure

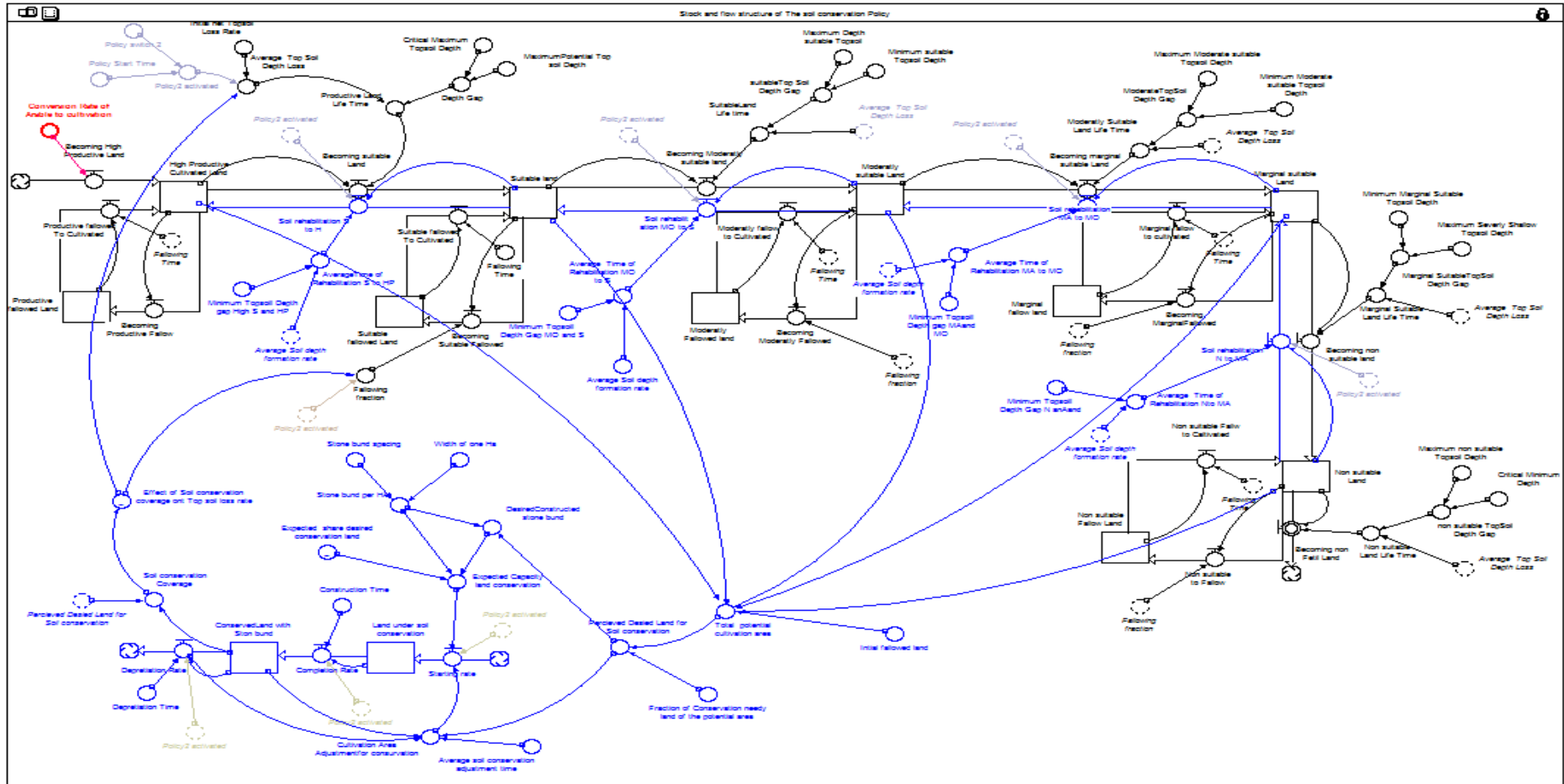

Figure 82: The stock and flow structure of the soil conservation policy (in blue)

In the explanatory model, we used net conversion rates (degradation rate) of land that is degraded into the various land classes (high productive, suitable land etc.). In this section, however, we analyze separately the net flow as inflow and outflow of each degraded land type. Hence, we have two flows for each of the land suitability classes. The rules governing these flows are different. All the outflows of each suitable class of land which results in the decline in fertility, are determined by the soil erosion, while all reverse flows of each suitable classes of land which results in the gain of fertility are determined by the organic matter decaying (or soil formation) process. Thus the purpose of the policy is to weaken the soil degradation process and reinforce the soil formation or sedimentation process. We use an estimate of average topsoil depth loss rate (for the degradation process - 4mm/year) and average top soil depth formation rate (for the decaying or sedimentation process - 0.2mm/year) to calculate the average life of the soil residing in each stock and to define the respective flows (Sonneveld, B. G. J. S. et al., 2002, Zelleke, G. et al., 2010).

With respect to soil conservation, we distinguish between two kinds of land (a) the land having soil conservation techniques called 'conserved land' and (b) the land in the process of soil conservation, called 'land on soil conservation'. This land is identified as stocks of the policy model. There are three flows associated with these land types with rates named with starting rate, completion rate, and depreciation rate. The starting rate refers the average hectares of land we plan to conserve each year. It depends on the size of land we need to conserve and the available capacity to conserve. The completion rate refers to the average hectares being conserved each year. It is defined based on the land in the conservation process. It is also important to notice the average amount of time required to complete once the land is in the land conservation stage. We used two years average time to complete the land once it is planned to conserve. Hence the completion rate is the first order adjustment of the land on conservation. The depreciation rate represents the process of the depreciation of the soil conservation mechanisms from the land for example terrace depreciate due to the re-deposition of the soil i.e. the terrace will no longer stop soil erosion if it is filled with the downstream soil deposition. Hence the conserved land becomes non-conserved after some time with the depreciation rate unless the conservation mechanism is updated. The depreciation rate is a first order adjustment of the conserved land.

The potential land that needs to be conserved includes cultivation land and the total fallow land. But a small fraction this land is assumed to be conserved before. The land desired to be conserved is the subtraction of the conserved land from the total potential cultivation and fallow land. Hence the land desired to be conserved need to be perceived by the government, local administrator etc. in order to be planned for conservation. Subsequently it should be adjusted with the existing conserved land, and the adjustment time so as to order in the starting rate. We have assumed the capacity for soil conservation will develop in the future as shown in the graph 83 below.

Width of a hectare (100m) and the conservation method spacing (10 m spacing of stone bund for the computation of the model) is applied to determine the required amount of particular conservation method required per hectare as well as the total amount of soil conservation work needed to conserve the cultivation land.

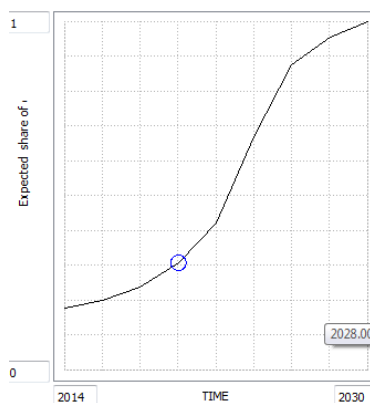

Figure 83: Expected capacity building fraction .

Soil conservation coverage is the proportion of the conserved land from the total land (perceived desired land for cultivation). The percentage of the land covered with soil conservation has important effect on the topsoil loss rate and the fallowing fraction. We claimed that the topsoil depth loss stops when the land conservation coverage is close to 100 %.

Soil_conservation_coverage

$$= \text{Conserved_Land_with_Ston_bund} / \text{Percieved_Desied_Land_for_Soil_conservation}$$

It is the effect of the soil conservation coverage that determines the extent to which reducing the top soil depth loss rate is reduced and so also the fallowing fraction. We represent the effect of soil conservation coverage on the average topsoil depth loss and

fallowing fraction by the graphical function shown figure 84 below. The graphical function can be interpreted as the average topsoil depth loss and the fallowing fraction will decrease as the coverage of the soil conservation increases. The more we conserve the soil, the less the top soil loss and the fallowing fraction will be.

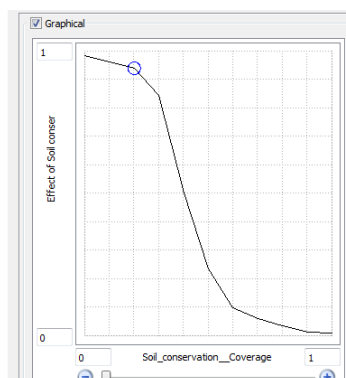

Figure 84: *The effect of soil conservation coverage on the average top soil depth loss and fallowing fraction.*

5.2 Agricultural Input Supply Capacity Building

Our second policy option focuses on the increase of land productivity through the intensification of agricultural input supplies, mainly the application of improved seed and fertilizer. This policy requires capacity building on supplying these inputs either through production (mainly for improved seed) or import (currently for fertilizer) i.e. capacity building requires capital such as; human power, manufacturing industries, land etc.

The results of our analysis indicates that the use of improved technologies particularly improved seed and fertilizer has stagnated in the first decade of the simulation, and there has been relatively better developments afterward up 2010. The coverage of improved seed and fertilizer was around 10 % and 54 %, respectively, in 2010. Hence, there are considerable potentials for increasing the coverage of the inputs so that the average productivity of the cultivation land increase. Moreover, the attractiveness of using fertilizer is well above 20. Attractiveness of using fertilizer refers to the ratio of gross additional revenue gained from additional yield to the cost of fertilizer applied. Here the attractiveness of using fertilizer only compares the advantage of applying fertilizer, not the extent of application. We can say that this policy is in line with the green economic policy that the government plan to implement in Ethiopia.

‘‘Intensify agriculture through usage of improved inputs and better residue management resulting in a decreased requirement for additional agricultural land that would primarily be taken from forests’’ (ECRGE, 2011).

‘‘Building a green economy will require an increase the productivity of farmland and livestock rather than increasing the land area cultivated or cattle headcount’’ (ECRGE, 2011).

Thus we claim that capacity building in agricultural input supplies will have a significant role in supplying the agricultural input to farmers. The increase in capacity causes an increase in the agricultural input supply which enhances the availability / accessibility of the inputs to the producers. This in turn increases the average total area coverage which, subsequently, leads to an increase in the average yield and production. Whereas, the increase yield provides increase in food availability in the market, it also insures an increase in consumption for producers.

5.2.1 Causal Loop Structure

The fundamental concept of this policy is to build input supply capacity based on the amount of cultivation land. In the causal loop structure, figure 91, the reinforcing loop R8, represent this capacity building policy. The loop characterizes the relationship between the cultivation land, input demand, capacity building, and input supply. The increase in cultivation land causes the desired input use to increase. The increase desired input use causes an increase in the agricultural input capacity, and agricultural input supply. The increase agricultural input supply, subsequently, increases the current yield. Together with the causal loop structure of the explanatory model, this completes the loop.

5.2.2 Stock and Flow Structure

We represented the current working capital and the capital under development by stocks named ‘functioning capital’, and ‘capital on order’. The capital on order could include the potential resources both human and material (such as manufacturing industries bought, land under preparation, people in training etc.) that will join the functioning capital after some time. The functioning capital is the capital currently working in the production and the supply of agricultural inputs. Thus, the two stocks have three flows capital ordering, capital acquisition, and capital depreciation. Capital ordering is adjustments of the gap between the desired capital and the functioning capital actually in pace plus the perceived capital depreciation rate. The desired input capital is the division of the desired input production

capacity by the unit production capacity. The equations of fertilizer and improved seed are handled separately and are given below (every variable is an array of the two input types).

$$\text{Desired_Capital[Fertilizer]} = \text{Desired_Input_amount[Fertilizer]} / \text{Unit_Production_Capacity[Fertilizer]}$$

$$\text{Desired_Capital[Improved_Seed]} =$$

$$\text{Desired_Input_amount[Improved_Seed]} / \text{Unit_Production_Capacity[Improved_Seed]}$$

It takes some time for surveying and reporting the amount cultivation land. Hence, the perceived amount of cultivation land is the reported amount of land that needs some input. The desired amount of input is the multiplication of the perceived cultivation land and the amount of input applied per hectare (both inputs). The desired amount of input indicates the size of desired production (supply) capacity. Currently Ethiopia is net importer of chemical fertilizers, but it produces improved seeds locally. Hence the capacity structure of fertilizer refers to the capacity to import and supply. In addition the structure could apply to building capacity for fertilizer production. Finally, the multiplication of functioning capital with the unit capacity production results in the current supply capacity of inputs. The increase in functioning capital causes an increase in the current supply capacity of inputs which, in turn, increases the availability of input supplies and, ultimately, increases the current yield. The stock and flow structure of this policy is presented in the figure below (since the model is too large to portray it in one page, we present only the additional structure).

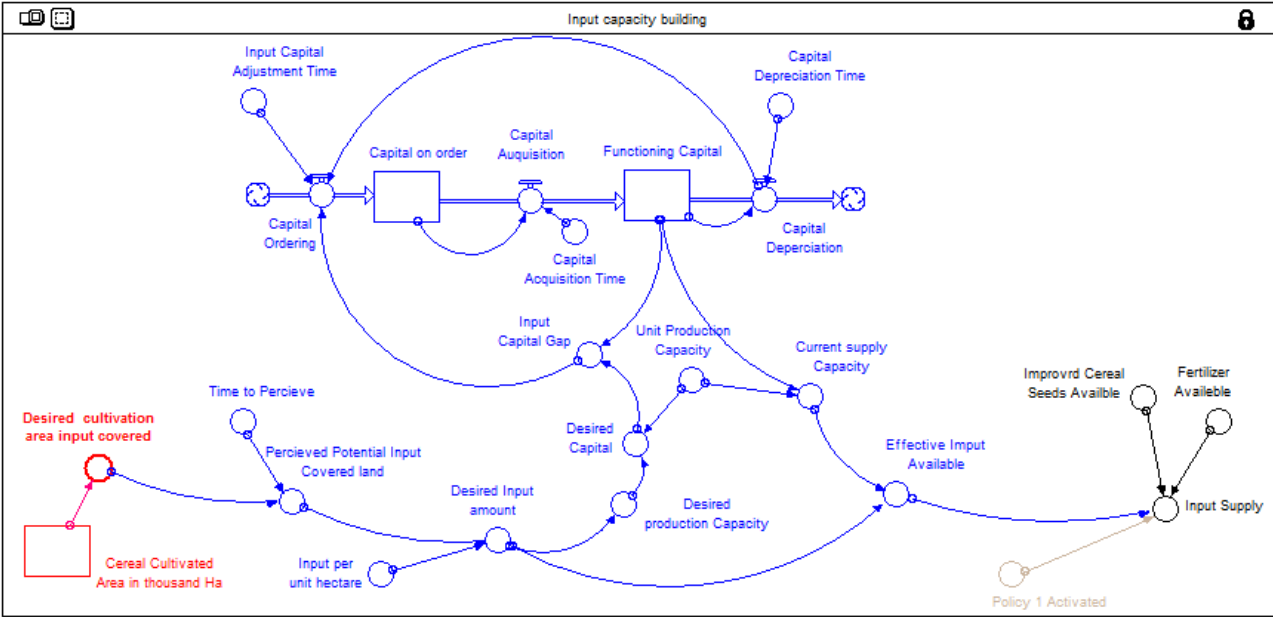

Figure 85: The stock flow structure of the capacity building policy.

5.3 Land Management (Adjustment)

In the third policy option, we focus on conserving the natural resource, potential arable land (forest or grazing land etc.) from being depleted into cultivation land. In this policy we aim at adjusting the cultivation land based on desired production given the current productivity. The cultivation land needed to be expanded only when the desired production is not met by the current yield of the existing cultivation land. The recent development of the cultivation land expansion has been mainly based upon the population pressure (desire) for new cultivation land. However, this will keep depleting the potential arable land in the future as the population continues to grow. And, most importantly, it has contributed less to the enhancement of yield as it gives a relief in satisfying temporary consumption demand. The land management policy allows the conversion of potential arable land in to cultivation land in the case of food insufficiency. But the policy preserves the potential arable land from being depleted when there is sufficient production. Moreover, in the application of this policy, increasing the productivity of the existing land weakens the need for depletion of the potential arable land. This policy is also in line with the policy direction stated in the green economy of Ethiopia.

“Deforestation and forest degradation must be reversed to support the continued provision of economic and ecosystem services and growth in GDP” (ECRGE, 2011).

It is therefore important to examine the accessibility / availability of food by the majority of the farmers from the two perspectives, the expansion of cultivation land, and the enhancement of the fertility of the land. The expansion of cultivation land has evidently increased production and resulted in the increase in availability of food in the national market at level. And it is important to increase the food availability in the market, especially for urban consumers. But if we further downscale our analysis to regional, sub-regional, or household level, the increase in production does not directly translate into an increase in the availability of food at these levels. This is primarily because, the new cultivation land is given to new farmers i.e. it does not improve the life of the original farmers. Secondly, some regions do not have sufficient land to expand as they have limited resources or they have already depleted the potential arable land. Thus, the intensification of cultivation land will increase the average availability of food in the market, but may not affect accessibility/ availability food for individual farmers. Hence it has limited contribution for decreasing

undernourishment. Only the urban consumers having purchasing power consume this food. On the other hand, an increase in production through the enhancement of land productivity for each farmer's land improves accessibility and availability food for the farmer, household, regional state, and the country. Moreover, the large share of this production is directly used for consumption by produces themselves. This contributes to the decrease in the prevalence of undernourishment.

5.3.1 Causal Loop Structure of Land Management Policy

In the main causal loop diagram, figure 91, the reinforcing loops R8 and R9 are the two loops representing the land management policy option. In the reinforcing loop R8, a further increase in current yield causes the desired cultivation area to diminish. That results in a decrease in the conversion of potential arable land into cultivation land, in cereal cultivation land, and in the conversion of cultivation land into non-fertile land (after a considerable delay). But the decrease in conversion of cultivation land into non-fertile land causes an increase in the potential yield, ultimately increasing the current yield which closes the loop.

Similarly, in the reinforcing loop R9, an increase in desired cereal consumption causes the desired cultivation area to increase. That, subsequently, causes an increase in the conversion of potential arable land into cultivation land, in cereal cultivation land, in cereal production, over time, in the inventory, in the shipment, and in the effectively nourished population. But the increase in the effectively nourished population causes a decrease in the prevalence of undernourishment, subsequently causing an increase in the population, which ultimately increases the desired cereal consumption, so as to close the loop.

Some of the model equations of the additional policy model are:

$$\text{Desired_Production[Tef]} = \text{.ComulativeAnnual_Desired_Cereal_Consumption_demand[Tef]} * (1 + \text{Seed_and_loss_fraction})$$

$$\text{Desired_cultivation_area} = \frac{\text{Desired_Production[Tef]}}{\text{Current_Yield[Tef]}} + \frac{\text{Desired_Production[Wheat]}}{\text{Current_Yield[Wheat]}} + \frac{\text{Desired_Production[Maize]}}{\text{Current_Yield[Maize]}} + \frac{\text{Desired_Production[Barely]}}{\text{Current_Yield[Barely]}} + \frac{\text{Desired_Production[Rice]}}{\text{Current_Yield[Rice]}} + \frac{\text{Desired_Production[Sorghum]}}{\text{Current_Yield[Sorghum]}} + \frac{\text{Desired_Production[Millet]}}{\text{Current_Yield[Millet]}} + \frac{\text{Desired_Production[Oats]}}{\text{Current_Yield[Oats]}}$$

5.4 Policy Testing

We choose to run the model up to 2025. Before we let the model produce projections, we extrapolate the variables governed by data inputs. The sixteen years data is used to forecast the future values of these variables using the forecast function of the software. The objective of this section is to compare / test the simulation results of the policy options compared to the business as usual case and, ultimately, to infer the implication for reality. In the policy models we assumed that the net import of cereals will slowly decrease to zero so that the country will be self-sufficient by 2025. Figure 86 shows this assumption reflecting the net import of cereals.

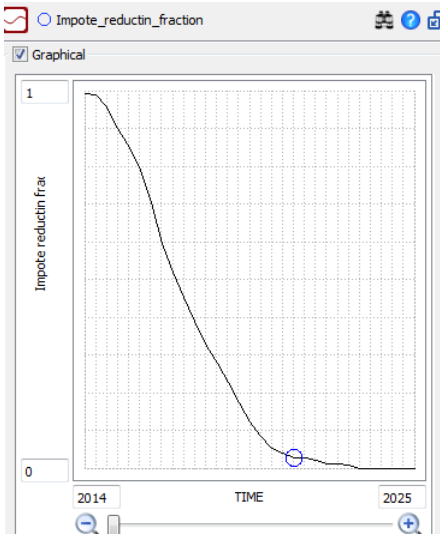

Figure 86: The fraction of import of cereals.

5.4.1 The Base Run

Our base run (business as usual) results from the model that has replicated the reference behavior and runs up to 2025. In other words it is the simulation result of the model with current policies in place and the exogenous variables continue current development in the future. Figure 87 shows the base run of some selected variables; potential arable land and cereal cultivation land, yields, production, and producer price of some cereals in addition to the prevalence of undernourishment.

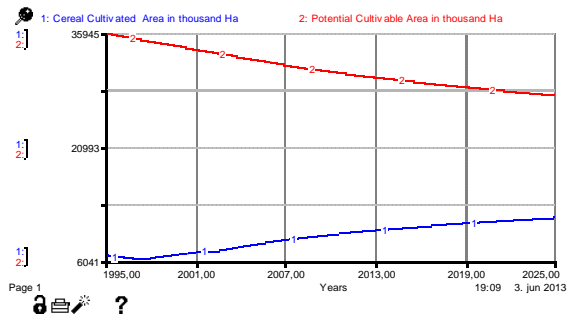

Figure 87 (a): Potential arable and cultivation land

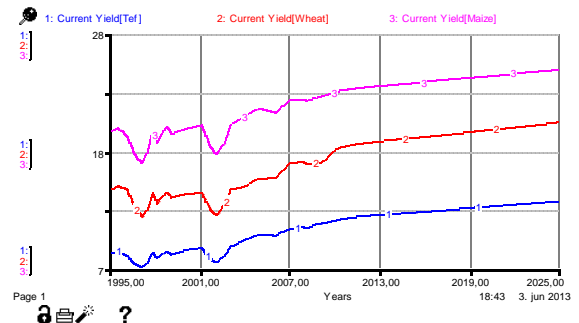

Figure 87 (b): Yields of cereals tef (blue), wheat (red), and maize (pink)

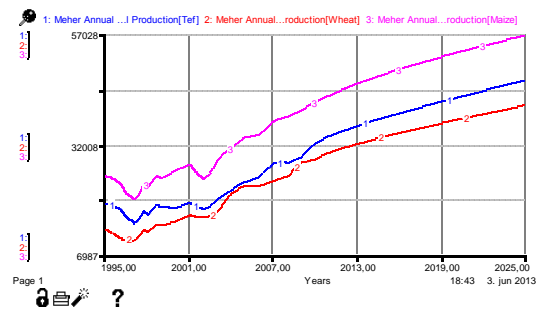

Figure 87 (c): Production of cereals tef (blue), wheat (red), and maize (pink)

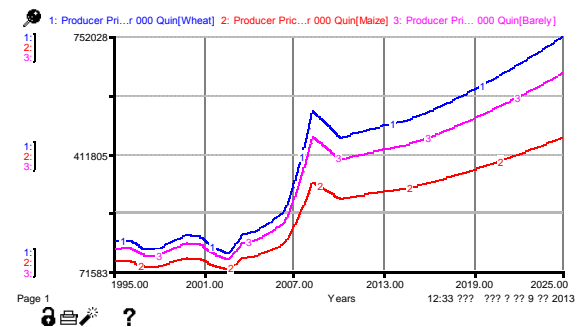

Figure 87 (d): Price of cereals tef (blue), wheat (red), and maize (pink)

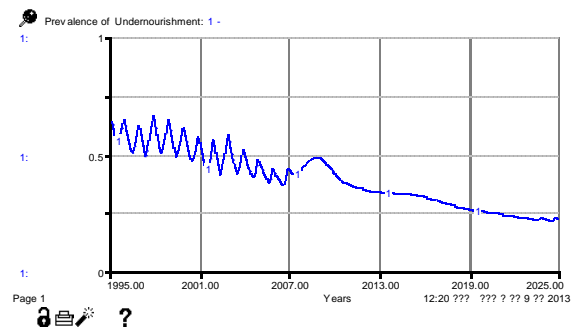

Figure 87 (e): Prevalence of undernourishment with purchasing power constrained

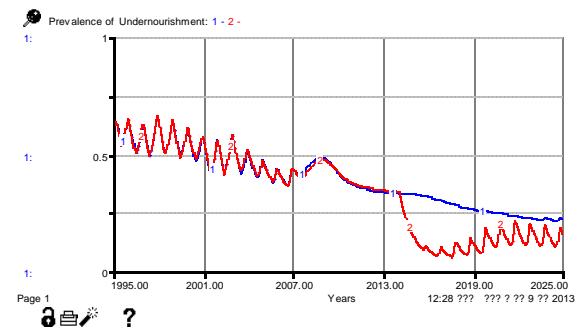

Figure 87 (f): Prevalence of undernourishment without purchasing power constrained

Figure 87: The bases run of some of the variable

As shown in the above figure 87, whereas the potential land (potential arable area) will continue to be depleted for the next 12 years, figure 87 (a)-red, the cereal cultivation area increases to around 12 million hectares figure 87 (a)-blue. The expected percentage decrease of the potential cultivation area is around 20 % from 1995, i.e. the reference year, while the expected percentage increase in the cereal cultivation land is around 80 % of the 1995 cultivation land.

The yield of most cereals is expected to increase, figure 87 (b), following the increase in coverage of inputs and the use of productive (virgin land) land acquired from available natural resources. The producer cereal price, figure 87 (c), is expected to grow with less than a 4 % inflation rate. The production of cereal also follows the trend and grows, figure 87 (d). Most importantly, the prevalence of undernourishment, figure 87 (e), is also expected to decrease to reach around 22 % in 2025. But the prevalence of undernourishment will be much lower than the base run if there is no purchasing power constraining consumption, figure 87 (f). The drop in prevalence of undernourishment in figure 87 (f) is because the cereal inventory was relatively high before the removal of the purchasing power constrained. Hence, both the availability (physical constraint) and the purchasing power of the population (financial constraint) are expected to constrain food consumptions. However, the prevalence of undernourishment may be as low as around 14 % by 2025 provided the expenditure grows sufficiently to cover the food expenses.

5.4.2 The Soil Conservation / Rehabilitation Policy Activated

As we discussed in section 5.1 soil conservation / rehabilitation policy is the first policy we choose to test in the model. This policy is a fundamental solution to the degradation problem, but it requires a huge amount of time before one can see the effect in the form of an increase in the productivity of the land. This is because; reducing or stopping the soil erosion helps to keep the soil fertile (through not allowing losing its water retaining capacity) rather than increasing the fertility. The reverse process; the formation of topsoil through decaying and sedimentation of organic matters (which is much slower than the degradation) helps the soil to increase its water retaining capacity and improves the fertility. But this process (decaying and sedimentation) usually involves much more time than the erosion process (around 20 times). Hence in the short run we expect only slight changes in the simulation result after the application of policy. It is important to note that even if the effect of this policy is very slow, even if we apply an aggressive policy, it does not mean that the policy is not effective in the long run. And in the long run the effect of this policy is expected to produce significant improvements in productivity and production.

The simulation results under this policy, compared to the base run, are presented in figure 88 below. The policy is activated in 2014, and the adjustment is made aggressive (every year).

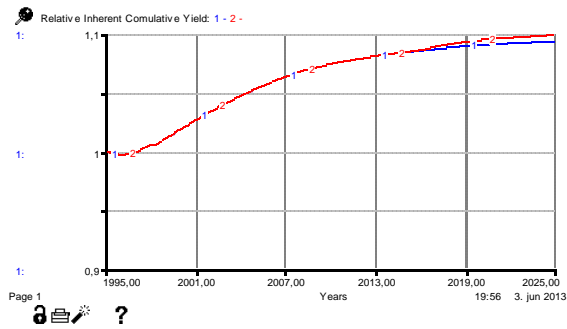

Figure 88 (a): Relative inherent yield base run (blue), policy (red)

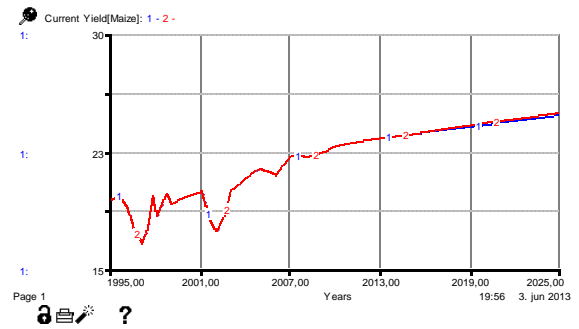

Figure 88 (b): Maize yield base run (blue), policy (red)

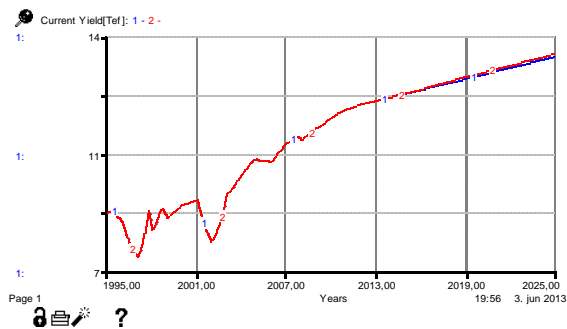

Figure 88 (c): Tef yield base run (blue), policy (red)

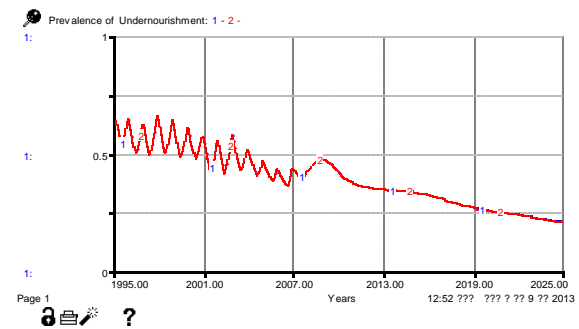

Figure 88 (d): Prevalence of Undernourishment base run (blue), policy (red)

Figure 88: The comparison of the base run and the soil conservation policy for some selected variables.

As shown from the simulation result, the graph of relative inherent yield of the policy is slightly above the base run. The same result is produced for the yields of cereals maize and tef and also for the prevalence of undernourishment. However the changes brought on by this policy is insignificant with in simulation horizon of this study due to the long time delay that is required for the rehabilitation to influence the yield.

5.4.3 Agricultural Input Capacity Building Policy Activated

We assumed the policy to increase capacity building to support agricultural input intensification starts at the beginning of 2014. The simulation results of the model show a progressive increase in yield of cereals, and a progressive decrease in the prevalence of undernourishment. The graph allowing us to compare the base run to the policy run as shown in the figure 89 below.

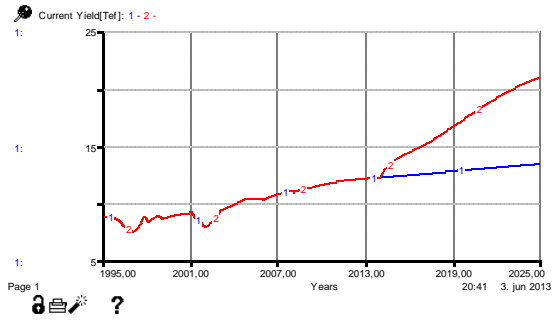

Figure 89 (a): Tef yield base run (blue), policy (red)

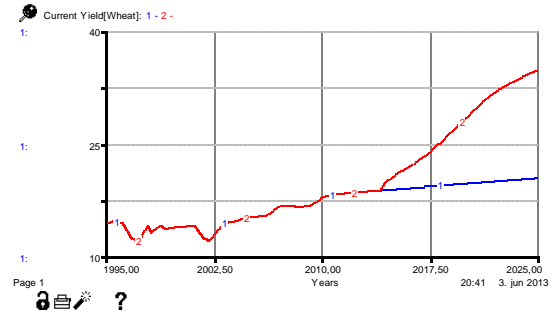

Figure 89 (b): Wheat yield base run (blue), policy (red)

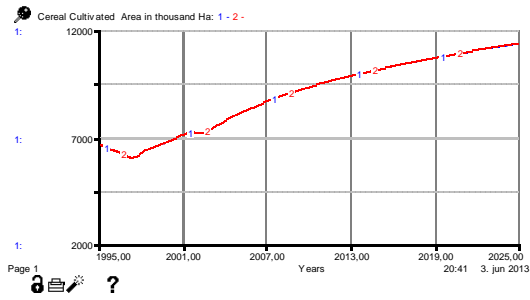

Figure 89 (c): Cereal cultivation area

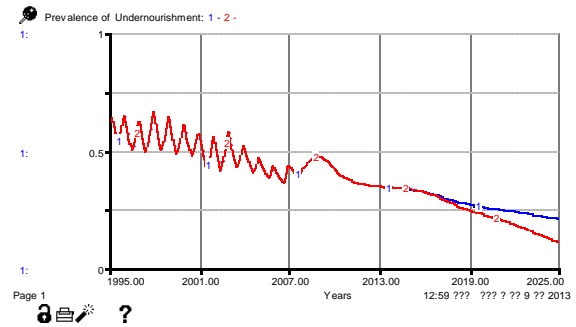

Figure 89 (c): Prevalence of undernourishment base run (blue), policy (red)

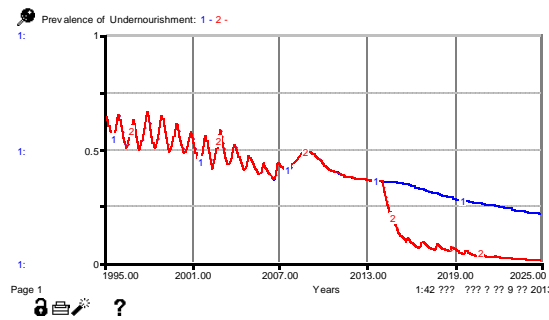

Figure 89 (d): Prevalence of undernourishment without purchasing power constrained

Figure 89: The simulation result of capacity building policy.

The yields of cereals demonstrate a dramatic increase in figure 89 (a), and (b) resulting from the policy activation. The policy is made aggressive on purpose to assess the effects of the third policy. It is very important to point out that the prevalence of undernourishment decreases figure 89 (c) because the yield of cereals has increased which ensures consumption, accessibility and availability of food for producers resulting in a decrease in the prevalence of

undernourishment from around 22 % to 11 % in 2025. A change in relative yield explains 25 % of the change in the per-capita expenditure. However, the decrease in the prevalence of undernourishment could be very high if there were no economic constraint to food consumption (see figure 89 (d)). With this policy, the prevalence of undernourishment is expected to reach around zero by 2020 provided that every individual is economically capable of purchasing the food available at market. So, there will not be a food supply constraint in the system after 2020.

5.4.4 The Sustainable Land management Policy Activated

As explained in section 5.3, this policy aims at keeping the natural resource i.e. land from being depleted converted to cultivation area when there is sufficient production. So the purpose is to avoid an increase in production through expansion of cultivation land, by enhancing the productivity of the land.

Thus, this policy is more effective when combined with the capacity building policy. This is because the production of cereal food has not been sufficient without the application of the capacity building policy (see figure 87 (f)). That implies the effect of land management policy could not be visible if there is no sufficient food supply, so it functions only when availability of food is ensured. Figure 90 shows the simulation behavior of this policy, the base run (1-blue), land management policy (2-red alone), and capacity building and land management policy together (3-pink).

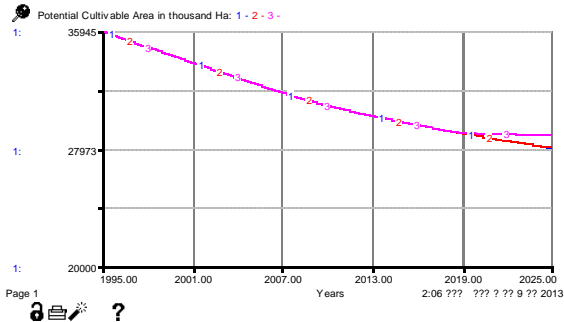

Figure 90 (a): Potential arable land base run (blue), land management policy (red), land management and capacity building policy (pink)

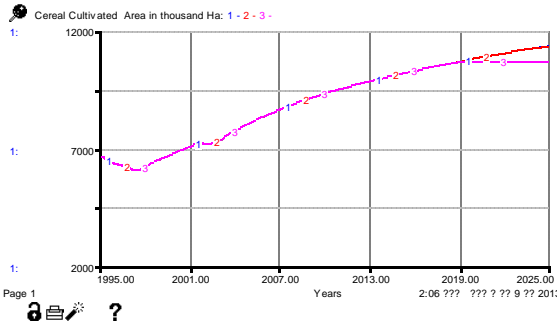

Figure 90(b): Cereal cultivation land base run (blue) land management policy (red), land management and capacity building policy (pink)

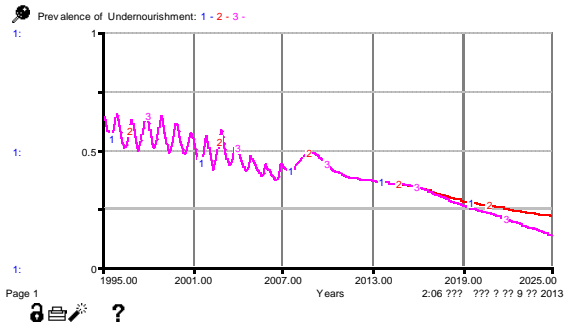

Figure 90 (c): prevalence of undernourishment base run (blue), land management policy (red), land management and capacity building policy (pink)

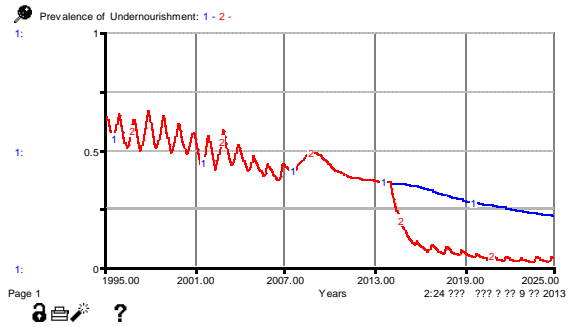

Figure 90 (d): Prevalence of undernourishment without purchasing power constrained (red) base run (blue)

Figure 90: The simulation behavior of the model when policy three is applied.

As shown in the figure 90, the application of the land management policy alone (red) does not show changes from the base run. While it is applied with the capacity building policy (pink) reduces the increase in cultivation land, (see figure 90 (a)), and stops the further depletion of the potential arable land starting around 2018 (see figure 90 (b)). The prevalence of undernourishment remains the same, (see figure 90 (c)). Furthermore, as seen in figure 90 (d) both policies, capacity building and land management without the economic constraint, the prevalence of undernourishment falls close to zero demonstrating that the availability of food is insured.

5.4.5 All policies Activated

When all the three policies are applied starting from 2014, a similar result that has been examined when both policies, capacity building policy and sustainable land policy has been shown. The effect of the soil conservation / rehabilitation policy is masked by the effects of the two policies. Figure 91 shows the simulation results of some of the variables.

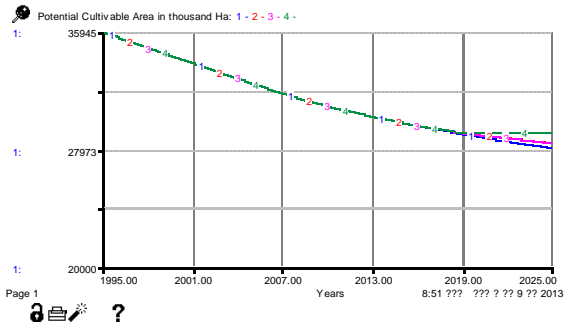

Figure 91 (a): Potential arable land

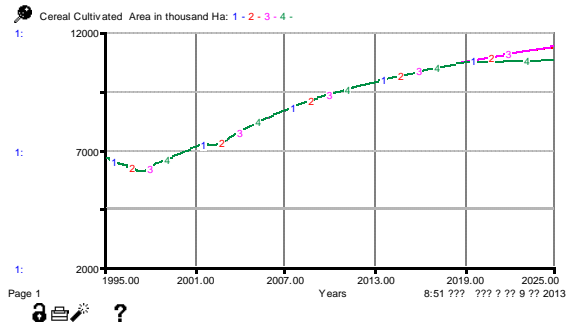

Figure 91 (b): Cereal cultivation land

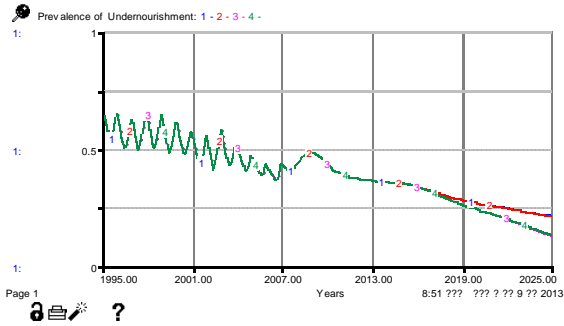

Figure 91 (c): Prevalence of undernourishment

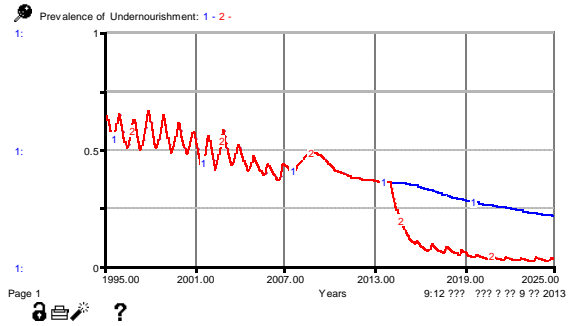

Figure 91 (d): Prevalence of undernourishment without purchasing power constrained

Figure 91: The simulation results when the three policies are activated.

As shown in the figure 91 above, the application of all policies reduce the depletion of the potential arable land figure 91 (a) after the desired food has been produced in 2020. It should be noted that the prevalence of undernourishment does not change (see figure 91 (c)) from the results seen in figure 90 (c). Similarly, the prevalence of undernourishment falls close to zero when the purchasing power constraint is removed, demonstrating that that the food production is sufficient to feed the population (see figure 91 (d)). In general, there is no significant change with the application of all policies, policy one, policy two, and policy three, on top of policy two and three, within the analysis time frame. This is mainly due to the less effectiveness of the land conservation policy.

Note: the land management policy is examined together with the capacity building policy (section 5.4.4).

5.5 Scenarios

This section presents the resulting simulation when the average main season rainfall and average per-capita expenditure is being introduced in the model to represent various scenarios in the future. The average main season rainfall and the average per-capita expenditure are set to change in three scenarios.

5.5.2 Rainfall Scenario

The rain fall in Ethiopia has been erratic and it is also uncertain in the future. Besides its randomness in nature, the average rainfall is forecasted to increase by 0.4 % in the 2020’s and 1.1 % in 2050’s (CRGE, 2011). We used three scenarios of average rainfall erratic rainfall distribution (the average rainfall distribution experienced for the last 12 years), and erratic rainfall distribution adjusted for a 0.4 % increase (projected climate changes for the 2020’s) or adjusted for 0.4 % decrease. The rainfall variability has been affecting both the amount of cultivation area and yields of cereal crops. In the years where there is an average rainfall higher or lower than the optimum average rainfall, this causes a decrease in both the cultivation land and the yield of the land. Figure 92, shows the amount of cultivation land, the yield of a cereal, the production of one cereal and the prevalence of undernourishment for the three scenarios compared to the base run.

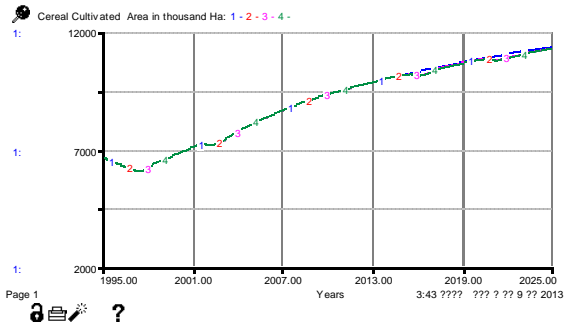

Figure 92 (a): Cereal cultivation land base run (blue), random (red), random⁺ (pink), and random⁻ (green)

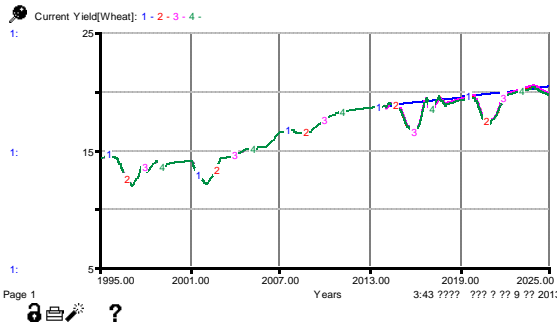

Figure 92 (b): Wheat yield base run (blue), random (red), random⁺ (pink), and random⁻ (green)

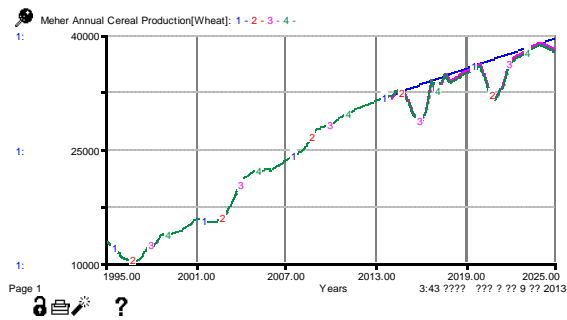

Figure 92(c): Wheat production base run (blue), random (red), random⁺ (pink), and random⁻ (green)

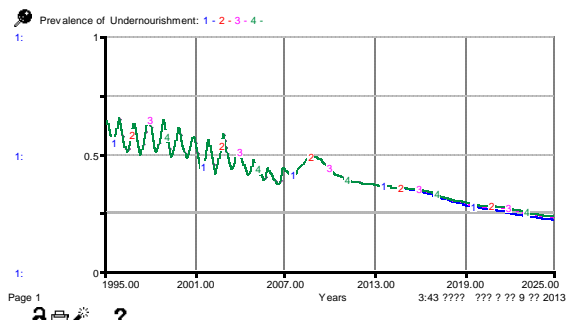

Figure 92(d) Prevalence of undernourishment base run (blue), random (red), random⁺ (pink), and random⁻ (green)

Figure 92: Rainfall scenarios

As shown in the figure 92 above, the yield, the cultivation area, and cereal production in general, the production are affected by the random rainfall (figure 92, a, b, c). The yield of cereals is more sensitive to the change in average rainfall than the cultivation land. Moreover, the slight increase or decrease in percentage of average rainfall (0.4 %) demonstrates insignificant change in the changes in cultivation land and cereal yield. The prevalence of undernourishment has also shown relatively very small changes (it increased) on those seasons where the average rainfall is negatively influence the production. Moreover, in the case of the erratic rainfall the food production is not stable (see wheat production in figure 92 (c)), it decreases considerably, and hence backup (disaster prevention in case of the worst) food reserve is recommended.

5.5.1 Expenditure Scenario

One of the main constrained of food security, in our analysis, has been the low purchasing power of the population. The purchasing power expressed as the average expenditure or budget allotted for food, determines the amount of food purchased. Hence, the amount of expenditure has been used as measure of the purchasing power. It is reviewed in the household and expenditure surveys that the average expenditure is used as an estimate of average income (section 3.3.2.3.2). In our model the per-capita expenditure is only partly endogenous i.e. the model only explains 25 % of the changes of the per-capita expenditure.

Ethiopia’s economy has been one of the world’s fastest growing economies in the last five years and is expected to continue over the coming years. The GDP (gross domestic product) is forecasted to grow more than 8 % per year for 2011-2016 (ECRGE, 2011). Ethiopia also aims to reach a middle-income status (GDP per capita of around 1,000 USD) by 2025. This objective is reflected in the growth and transformation plan (GTP) of the government, which also intends to increase an 8 % increase in household income and also provide food security for growing population (ECRGE, 2011).

In our context, the increase in income / expenditure implies an increase in purchasing power to acquire food consumption. And hence, this decreases the prevalence of undernourishment provided that there is available food in the market. A percentage growth rate of 2 %- slow, 4 %-moderate and 8 %-high growth rates are used to examine the future development of the prevalence of undernourishment. Figure 93 demonstrates the simulation results of prevalence of undernourishment with the three scenarios of expenditure.

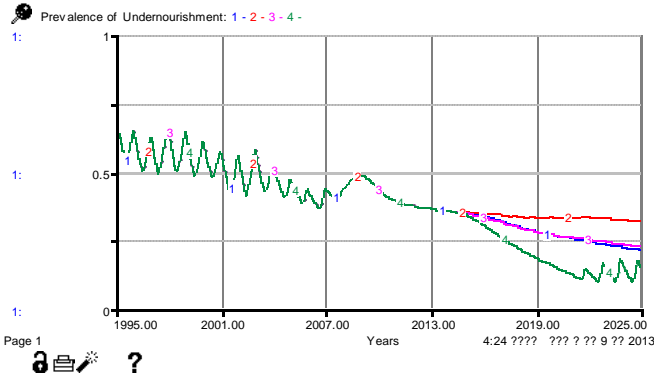

Figure 93: The development of prevalence with the per-capita expenditure scenarios base run (blue), slow growth (red), moderate growth (pink), and fast growth (green).

The simulation result demonstrates that the prevalence of undernourishment is more constrained by the purchasing power (2-red) than the base run (1-blue) when the slow economic growth scenario is applied. Whereas the prevalence of undernourishment shows the almost same result as the base run in the moderate economic growth (3-pink), , it declines faster in the fast economic growth scenario (4- green) until the food availability is the constraint. Hence, the fast economic growing is the best option in alleviating the food insecurity problem. We claim that the effect of these scenarios is similar if it is applied in the policy options.

Chapter Six: Conclusion and Recommendation

The study of food security requires examining the interaction of (a) the growing consumption demand of a growing population, (b) the production of food through which the supplies are realized, and (c) the market, on which the price and budgets are determining the actual accessibility of food / cereals. In each of these sectors there are complex characteristics such as: stocks, flows, time delays, non-linearity, and feedback cycles, that influence the understanding of the main structure. For example, the effect of rainfall on cultivation land and yield, effect of inventory ratio on price, the effect of prevalence of undernourishment on death and life expectancy, the time delay in the soil erosion affecting the yield, the time delay of soil conservation measures to improve yield, and the time delays of building capacity to increase production etc. are some of the complex relationships involved in the study of food security.

For the last one and a half decades, Ethiopia has experienced a progressive improvement in reducing the percentage of population who continuously consume calories well below the minimum requirement. However, this percentage still remains at a higher level than intended. System dynamics has helped us address and examine this problem as it has unfolded in the past and also is being used for further analysis in the definition of future policy options and the test of these policy options.

System dynamics has never been used in studying food security in Ethiopia at national level. However, it has been used to study food security in some other part of the world, Colombia (Giraldo, D.et al., 2011). But the food security indicator and the model used in this thesis is quite different. Even if system dynamics has not been used to analyze the complex food security problem in Ethiopia, there has been considerable amount of research studied in this area. Hence, this thesis is an addition to the existing literature. The model in this thesis explains in detail how the complex interaction of various variables networked in the real environment to result in the current conditions. Furthermore, the model structure is used to examine future projections, future policy options and their impact to the system.

6.1 Major Findings

The growing population has been requiring a growing food consumption which under normal circumstances is expected to be satisfied by the domestic production. And reducing food insecurity, or prevalence of undernourishment, requires correspondingly increasing the availability of food / cereals as well as correspondingly increasing accessibility to food. In other words, not only do the food supplies need to meet the growing consumption needs of the population. The food that is available on the market must also be accessible (economically) to the population. Accessibility of food is, in this thesis, addressed from the economic point of view i.e. the purchasing power of the budget for food compared to the current price of the food.

The results of this analysis demonstrated that both the availability and accessibility of food has been the main constraints of the food consumption, food security. The prevalence of undernourishment was kept from dropping further down due to the constraints of accessibility and availability of the food. There has been a change in the dominance the two constraints over time. The availability of food, due to insufficient production along with a relatively stable food price, has resulted in the availability to dominate the development over the first decade of our simulation (1995-2005). Even if, the food production together with the per-capita food expenditure has increased in the late 2010, rocketed increase in food price takes over the dominance to the accessibility food. This result is generally, in line with the results found in the literature (Bikora, G., 2003, Proceedings of the Food Security Conference p.5, Demeke, M., 2003, Proceedings of the Food Security Conference p.5, Awlachev et al. 2010).

It is also shown that the expansion of cultivation land caused by the growing population pressure has resulted in the increase in food supply. The cereal / food production increase is predominantly attributed to the intensification of cultivation land: rather than the increase in yield of cereals. However, besides the intensification of cultivation land, the new cultivation land being adopted from potential arable land has a higher inherent / potential yield than the already used / degraded land. Hence the contribution of this land to the average inherent yield of the land has been significant. Therefore, the increase in the average inherent yield of the land, together with the relative increase in the application of improved technologies (improved seed and fertilizer) can explain the recent increase in the average yield of cereal.

The cultivation land has been passing through soil erosion, which has caused a decrease in the water retaining capacity of the soil as the topsoil washed out resulting in a decrease in inherent / potential yield. But since the process of land degradation develops very slowly development, the effect of land degradation on the yield of cereals is not very significant within the time frame of our analysis.

The other important result of our study concerns the interaction between the price and the input-output of agricultural products. As pointed by Demeke M. (2003, Proceedings of the Food Security Conference 2003 p. 5), the relative low price of agricultural products has not encouraged investments in the use of agricultural inputs (fertilizer and improved seed). Our result showed that, the producers apply inputs based on the input supplies. The analysis did not show an increase in use of agricultural input caused by the increase in the revenue obtained from the sale of agricultural products or caused by a decrease in price of inputs. However, the result shows that producers (farmers) spend a large portion of their sales, or are required to sell a larger percentage of their production to purchase the agricultural inputs. In this regard, it is important to mention that, in more recent years the government is the main supplier of agricultural inputs and it is not likely to expect the behavior of a free market where there is price competition.

The increase in cereal production during the late 2010 has not caused the correspondingly decrease in the price of cereals, except for slight price changes in 2009 / 10. Rather, price of cereals has been influenced by the average food inflation rate and not so much of the availability of cereal in stock. Even in the seasons / years when there were small amount of cereals in the inventory, the price of cereals remained relatively stagnant. The increase in food price, especially, during the period 2007-2009, has resulted in a significant drop in the purchasing power of the population. That, subsequently, causes a slight increase in the prevalence of undernourishment during those years.

The simulation results produced by the model also showed that the need for future increase in food supplies and there is a need for improvements in the purchasing power of the population in order to ensure food security. Policy options, such as soil conservation, sustainable land management and capacity building for improved input supplies, are tested in the model for long term and short term policy interventions.

6.2 Limitation of the Study and Future Research Areas

The study has some limitations. First, the boundary of the study includes only cereals which constitute an average of 58 % to 69 % of the daily caloric consumption of the population at the country level. We endogenously examine the consumption, production and marketing of cereal. A more inclusive way of studying food security would be to examine the overall agricultural production and overall daily calorie consumption.

Second, the level of aggregation of this study is at a national level. Therefore the interpretation of the results of the model or research should be considered with a great care. To downscale the results into regional or sub-regional levels does not always provide meaningful results. For example, the cereal calorie share in a daily consumption is not the same in urban and rural area or in some regions like Amhara or Oromia or SNNPR.

Third, in the land sector of the model we used topsoil losses caused by water erosion that resulted in a decrease in the water holding capacity of the soil that would, negatively affect the inherent / potential yield of the land. This version of the structure is sufficient for the purpose of this thesis. However, there is room to improve the model by adding the nutrient value of the soil and the recycling of nutrients and then create possible links to yield of the model.

Finally, in the formulation of the yield of cereals, we used the effect of average rainfall and this effect is the same for every cereal type. But each cereal could possibly react differently to a change in the average rainfall depending upon the environment and the condition of the cultivation area.

This research also indicates future research areas. First of all, this research (model) can constitute a very good point of departure for examining other socio-economic issues of the country, such as health, education, GDP etc. Second, there is room for making the models for each regional states in the country so that the problem, and associated resources, may be managed accordingly. Third, it is important to study the policy aspect of this research to test whether increasing producer price (farm get price) could improve food security and investment in the area. Because all producers do not produce all the food they consume, in some cases they are also consumers, they need to buy the farm products they did not produce. Fourth, many complex issues of the country that involves delays, non-linearity, and feedbacks such as; water management, sustainable energy use, telecommunication and electric service

expansion and planning etc. could better be studied using the system dynamic method presented in this thesis. This is because this method provides sufficient flexibility for handling such complex issues.

Finally, studying the economy, such as the income, expenditure etc. endogenously will create a more complete understanding of the food security problem. In our study expenditure has been only partly endogenously used (25 %) to the model and endogenizing the variable will help our understanding to the main poverty causing problems.

References

- Ali, M. et al. (2011) State of Food Insecurity and Socio-Economic Sustainability in Drought Prone North Wollo Zon, Ethiopia: A Case Study, *Asian-Pacific Journal of Social Science ISSN 0975-5942 Vol.III(2), Jul-Dec 2011, pp.78-79*
- Amede, T. (2001) Reversing the degradation of arable land in Ethiopian Highlands: *Managing African Soil No.23*
- ARS (2002) A Strategic Plan for the Sustainable Development, Conservation, and Management of the Woody Biomass Resource, *Final Draft*.
- Andersen (2009) Food Security: definition and measurement: Since+ business Media B.V. &International Society for plant Pathology: *Published online: 21 January 2009*.
- Awlchew, S. B. et al. (2010) Irrigation potential in Ethiopia Constraints and opportunities for enhancing the system.
- Barlas, Y. (1994) Model Validation in System Dynamics: *the 1994 International System Dynamics Conference*.
- Berry, L. (2003) Land Degradation in Ethiopia: Its Extent and Impact.
- Bewket, W. (2009) Rainfall variability and crop production in Ethiopia: Case study in the Amhara region: *Proceedings of the 16th International Conference of Ethiopian Studies*.
- Bikora, G. (2003) The Food Security Challenges in Ethiopia: *Proceedings of the food security conference 2003 p.15, Addis Ababa, Ethiopia*.
- Bot, A. J. et al.(2000) Land Resources Potential and Constraints at Regional and Country Levels.
- BGRS. (2003) A Strategic Plan for the Sustainable Development, Conservation, and Management of the Woody Biomass Resource.
- Braun, W. (2002) The System Archetypes.
http://www.albany.edu/faculty/gpr/PAD724/724WebArticles/sys_archetypes.pdf
- Choadhokak, A. P. (2003) Attaining Food Security with Integrated Approach to Agricultural Development : *Proceedings of the Food Security Conference 2003 p.139, Addis Ababa, Ethiopia*.
- Croppenstedt, A. et al. (1996) Determinants of Adoption and Levels of Demand for Fertilizer for Cereal Growing Farmers in Ethiopia: *WPS /96-3*.
- Croppenstedt, A. et al. (1996) An Analysis of the Productivity and Technical Efficiency of Cereal Growing Farmers in Ethiopia: Evidence from the Tree Regions, *Mimeo, Center for study of African Economies, Oxford University*.

CSA (1995-2011) Agricultural Sample survey: Area and production for Major Crops, Volume I (for private peasant holdings Meher season: Statistical bulletin).

CSA (2000) Ethiopia Demographic and Health survey, Addis Ababa.

CSA (2005) Ethiopia Demographic and health survey, Addis Ababa.

CSA (2011) Ethiopia Demographic and Health Survey, Addis Ababa.

CSA (1995/6) Household Income, Consumption and Expenditure survey: Revised Report, statistical report bulletin 204.

CSA (1999/00) Household Income, Consumption and Expenditure survey: statistical report bulletin 258.

CSA (2004/5) Household Income, Consumption and Expenditure survey: Analytical report, statistical report bulletin 394.

CSA (2004/5) Household Income, Consumption and Expenditure survey: statistical report bulletin 394. Volume II.

CSA (2010/11) Household Consumption and Expenditure survey Analytical report, statistical report bulletin 394. Volume II, bulletin 563.

Demeke, M. (2003) Agricultural Development in Ethiopia: the Challenges of Overcoming Famine: *Proceedings of the Food Security Conference 2003 p. 5, Addis Ababa, Ethiopia.*

Denboba, M. A. (2005) Forest Conversion-Soil Degradation-Farmer's Perception Nexus: Implication for Sustainable Land use in the South west of Ethiopia, *Ecology and Development Series No, 26, 2005.*

Dercon, S. et al. (2009) Growth from Agriculture in Ethiopia: Identifying Key Constraints. *A paper presented as part of study on Agriculture and growth in Ethiopia.*

Dercon, S. et al. (2009) In Search of a Strategy: Rethinking Agriculture-led Growth in Ethiopia. *Synthesis paper prepared as part of a study on agriculture and growth in Ethiopia.*

DRMFSS (2011) National Guidelines on Targeting Relief Food Assistance.

Eaton, D. (1996) The Economy of soil Erosion: A Model of Farm Decision Making, *Environmental Economic Programme: Discussion Paper DP 96-01.*

ECRGE (2011) Ethiopia's Vision for a Climate-Resilient Green Economy.

ECRGE (2011) Ethiopia's Climate-Resilient Green Economy: Green Economy Strategy.

EHNRI and FAO (1997) Food Composition Table for use in Ethiopia: Part III.

EHNRI and FAO (1997) Food Composition Table for use in Ethiopia: Part IV.

Ersado L. (2005) Small-Scale Irrigation Dams, Agricultural Production, and Health: Theory and Evidence from Ethiopia: *World Bank Policy Research Working Paper 3494.*

FAO/WFP Special Report (2009) Crop and Food Security Assessment Mission to Ethiopia: Integrating the Crop and Food Supply and the Emergency. *Food Security Assessments, Phase II*
FAO/WHO/UNU (2001) *Human Energy Requirements: Joint Report* FAO/WHO/UNU (2001) *expert consultation, Food and nutrition Technical Report Series 1*

FAO (2013) FAO-Food Security Indicators.
<http://faostat3.fao.org/home/index.html#DOWNLOAD>

FAO (2009) the State Food Security in the World: Economic Crises and Lessons Learned.

FAO Food Security Statistics < <http://www.fao.org/economic/ess/ess-fs/en/> >

FAO (2003) Trade Reforms and Food security: Conceptualizing the linkages.
World Health Organization- on line< <http://www.who.int/trade/glossary/story028/en/>>

FAO (2006) Food Security Competitiveness: Concepts and Perspectives: *Presentation of Caribbean Conference on Education for Rural people.*

FAO (2001) Soil Fertility Management in Support of Food Security in Sub-Saharan Africa.

FAO (2001) Food Balance sheets: A Hand Book.

Gabriel, A.H (2003) Feature of Grain Marketing Networks in Ethiopia: A synopsis of the implications for achieving Regional Food Security Objectives, *Proceedings of the food security conference, Addis Ababa, Ethiopia*

Gebremariam, A.et al. (2005) Health Service, a Health Environment, and Malnutrition in Ethiopia. In Benson, T. (p.131-162) *An Assessment of the causes of Malnutrition in Ethiopia, A contribution to the formulation of a national Nutrition Strategy for Ethiopia. International Food Policy Research Institute Washington, DC, USD.*

Giraldo, D. P. et al. (2011) Effect of Food Availability Policies on National Food Security: *Colombia case: the 29th International Confrence of System Dynamics, Washington.*

Giraldo, D. P et al. (2008) Food security in Development Countries:A systemic perspective: *The 2008 International conference of system dynamics, Greece.*

GIZ (2010/11) International fuel Price: seventh edition.

Godfray, H.C.J., J.R. et al.(2010) Food security: the challenge of feeding 9 billion people, *Science* 327(5967):812-18.

Jolejole-Forman, M. C. et al. (2012). Land Degradation's Implications on Agricultural Value of production in Ethiopia: A look inside the bowl: *selected.*

Kaluski, D.N. et al. (2001) Food Security and Nutrition- the Ethiopian Case for Action, *Public Health Nutrition* 5(3), 373-381.

Keyzer, M. A. et al. (2001). The Effect of Soil Degradation on agricultural Productivity in Ethiopia: a Non-Parametric Regression analysis.

Kassam, A. H. et al. (1991) Agro-Ecological Land Resource Assessment for Agricultural Development planning: a case study of Kenya resource Data base and Land Productivity (FAO).

Messerle R. (2011) Famine Early Warning Systems during Conflict: *Seminar paper 2011 found* <http://www.grin.com/en/e-book/177973/famine-early-warning-systems-during-conflict#inside>

MARD (2010), Sustainable Land Management Technologies and Approaches in Ethiopia.

MH (2003) Ministry of Health: Nutritional Extension Package.

Matsumoto, T. and Yamano, T. (2010) The Impact Credit on Crop Production and Income in Ethiopia: *GRIPS Discussion Paper 10-23*

OANDA (online source), Average Exchange Rate, found : <http://www.oanda.com/currency/average>

Rashid, S. (2009) Fertilizer in Ethiopia: Policy, Achievements, and Constraints. *Prepared for the Fertilizer Policy symposium of the COMESA, agriculture Market Program (AAMO), Livingstone, Zambia, June 15 2009.*

Rashid, S. (2010) Staple Food Price in Ethiopia. *Paper for the COMESA policy seminar on “Variation on staple food price: Causes, consequence, and policy options”.*

Rashid, S. et al. (2012) Fertilizer in Ethiopia: The policy, Value Chain, and Profitability. *IFPRI/USAID-CIAFS Analytical support to ATA.*

Rome Declaration on World Food Security, in FAO, *Report of the World Food Summit, Rome 13 to 17 November 1996*, Part I, Appendix (FAO, 1996); <http://www.fao.org/wfs/index_en.htm>.

Sonneveld, B. G. J. S (2002) Land under pressure: The impact of water erosion on food production in Ethiopia.

Sonneveld, B. G. J. S. Et al. (2002) Land under Pressure: Soil Conservation Concerns and Opportunities for Ethiopia: *Center for world food studies of the Vrije University (SOW-VU), Amsterdam, The Netherlands, Received, 4, Jan 2002.*

Sterman, J. (2000) Business Dynamics: Systems Thinking and Modeling for a Complex World. Irwin/McGraw-Hill

Sutcliffe, J. P. (1993). Economic Assessment of Land Degradation in The Ethiopian Highlands: a Case Study.

Tesfahun, F. et al. (2003) Challenges and Prospects of Food Security in Ethiopia. *Proceedings of the Food Security Conference 2003, Addis Ababa, Ethiopia.*

WBISPP (2004) Forest Resource of Ethiopia.

Wiebe, K. (2003) Linking Land Quality, Agricultural Productivity, and Food Security: *Agricultural Economic Report No. 823.*

Yesuf, M. et al. (2005) Cost of land Degradation in Ethiopia: A Critical Review of Past Studies: Environmental Economic policy Forum in Ethiopia International Food Policy Research institute.

Yu, B. et al. (2011) Cereal Production and Technology Adoption in Ethiopia: *International Food Policy Research Institute, ESSP II writing paper 31.*

Zelleke, G. et al. (2010) Fertilizer and Soil Fertility Potential in Ethiopia: Constraints and opportunities for enhancing the system *paper prepared for presentation at the international association of Agriculture.*

Appendix: Sensitivity Analysis

Figure 94 shows the sensitivity analysis of relative inherent yield, Maize yield, and prevalence of undernourishment with the change in top soil loss rate.

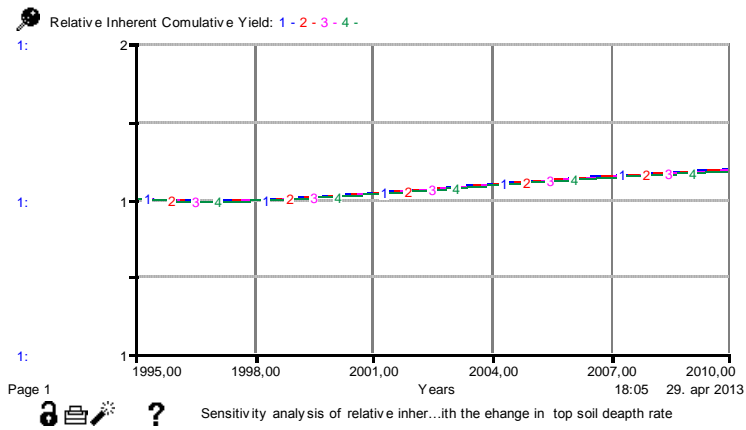

Figure 94 (a): Relative inherent yield

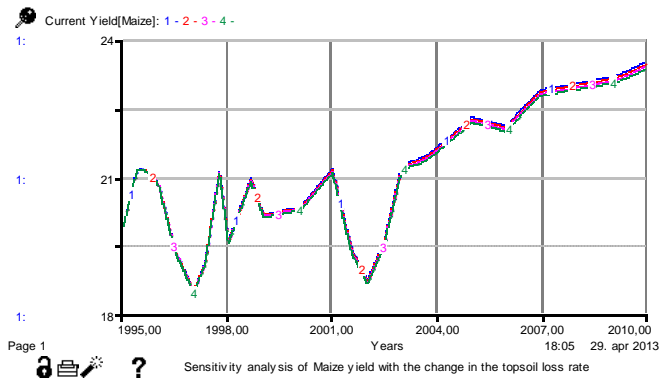

Figure 94 (b): Maize yield

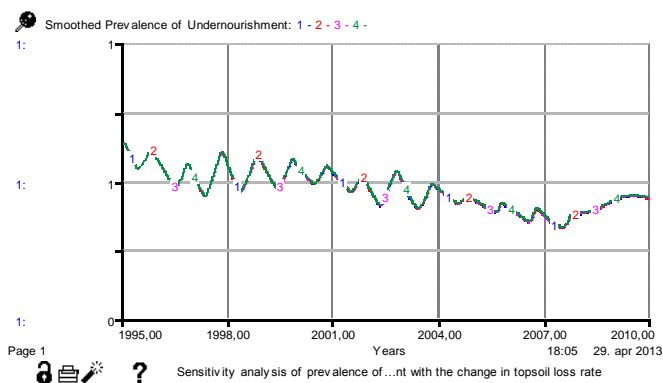

Figure 94 (c): Prevalence of undernourishment

Appendix B: Model Equations

$$\text{Cash}(t) = \text{Cash}(t - dt) + (\text{Revenue} - \text{Revenue_used_per_year}) * dt$$

$$\text{INIT Cash} = 550000000$$

UNITS: birr

INFLOWS:

Revenue =

$$\begin{aligned} & \text{Producer_Price_per_000_Quin}[\text{Tef}] * \text{Sale_Cereals_Shipment}[\text{Tef}] + \text{Producer_Price_per_000_Quin}[\text{Wheat}] \\ & * \text{Sale_Cereals_Shipment}[\text{Wheat}] + \text{Producer_Price_per_000_Quin}[\text{Maize}] * \text{Sale_Cereals_Shipment}[\text{Maize}] \\ & + \text{Producer_Price_per_000_Quin}[\text{Barely}] * \text{Sale_Cereals_Shipment}[\text{Barely}] + \text{Producer_Price_per_000_Quin} \\ & [\text{Rice}] * \text{Sale_Cereals_Shipment}[\text{Rice}] + \text{Producer_Price_per_000_Quin}[\text{Sorghum}] * \text{Sale_Cereals_Shipment} \\ & [\text{Sorghum}] + \text{Producer_Price_per_000_Quin}[\text{Millet}] * \text{Sale_Cereals_Shipment}[\text{Millet}] + \text{Producer_Price_per_0} \\ & 00_Quin[\text{Oats}] * \text{Sale_Cereals_Shipment}[\text{Oats}] \end{aligned}$$

UNITS: birr/yr

OUTFLOWS:

$$\text{Revenue_used_per_year} = (\text{Cash}/\text{Revenue_Consumption_Time}) * \text{Share_of_Producers_using_Fertilizer}$$

UNITS: birr/yr

$$\begin{aligned} \text{Cereal_Cultivated_Area_in_thousand_Ha}(t) = & \text{Cereal_Cultivated_Area_in_thousand_Ha}(t - dt) + \\ & (\text{Conversion_Rate_of_Arable_to_cultivation} + \text{Conversion_of_Temporary_Fallow_toCereal_Cultivation_area} \\ & - \text{Degradation_Rate} - \text{Conversion_of_Cultivated_Area_to_Temporary_fallow}) * dt \end{aligned}$$

$$\text{INIT Cereal_Cultivated_Area_in_thousand_Ha} = 6652.56$$

UNITS: hectare

INFLOWS:

Conversion_Rate_of_Arable_to_cultivation =

$$\text{MIN}(\text{Change_of_Arable_to_Cereal_Cultivation}, \text{Cereal_Cultivation_Area_Adjustment})$$

UNITS: hectares/yr

Conversion_of_Temporary_Fallow_toCereal_Cultivation_area =

$$\text{Land_Degradation_series.Fallow_to_Cultivation_Total}$$

UNITS: hectares/yr

OUTFLOWS:

$$\text{Degradation_Rate} = \text{Land_Degradation_series.Becoming_non_Fetil_Land}$$

UNITS: hectares/yr

$$\text{Conversion_of_Cultivated_Area_to_Temporary_fallow} = \text{Land_Degradation_series.Becoming_fallow_Total}$$

UNITS: hectares/yr

$$\begin{aligned} \text{Cereal_Inventory_In_000_Quin[Tef]}(t) &= \text{Cereal_Inventory_In_000_Quin[Tef]}(t - dt) + \\ &(\text{Delivery_of_cereals[cereal]} + \text{Comercial_Farm_Cereal_Delivery[cereal]} - \\ &\text{Consumption_Shipment_of_cereal[cereal]} - \text{Industry_Shipment[cereal]} - \text{Post_Harvest_Loss[cereal]}) * dt \end{aligned}$$

$$\text{INIT Cereal_Inventory_In_000_Quin[Tef]} = 2000$$

UNITS: quintal

$$\begin{aligned} \text{Cereal_Inventory_In_000_Quin[Wheat]}(t) &= \text{Cereal_Inventory_In_000_Quin[Wheat]}(t - dt) + \\ &(\text{Delivery_of_cereals[cereal]} + \text{Comercial_Farm_Cereal_Delivery[cereal]} - \\ &\text{Consumption_Shipment_of_cereal[cereal]} - \text{Industry_Shipment[cereal]} - \text{Post_Harvest_Loss[cereal]}) * dt \end{aligned}$$

$$\text{INIT Cereal_Inventory_In_000_Quin[Wheat]} = 4000$$

UNITS: quintal

$$\begin{aligned} \text{Cereal_Inventory_In_000_Quin[Maize]}(t) &= \text{Cereal_Inventory_In_000_Quin[Maize]}(t - dt) + \\ &(\text{Delivery_of_cereals[cereal]} + \text{Comercial_Farm_Cereal_Delivery[cereal]} - \\ &\text{Consumption_Shipment_of_cereal[cereal]} - \text{Industry_Shipment[cereal]} - \text{Post_Harvest_Loss[cereal]}) * dt \end{aligned}$$

$$\text{INIT Cereal_Inventory_In_000_Quin[Maize]} = 3000$$

UNITS: quintal

$$\begin{aligned} \text{Cereal_Inventory_In_000_Quin[Barely]}(t) &= \text{Cereal_Inventory_In_000_Quin[Barely]}(t - dt) + \\ &(\text{Delivery_of_cereals[cereal]} + \text{Comercial_Farm_Cereal_Delivery[cereal]} - \\ &\text{Consumption_Shipment_of_cereal[cereal]} - \text{Industry_Shipment[cereal]} - \text{Post_Harvest_Loss[cereal]}) * dt \end{aligned}$$

$$\text{INIT Cereal_Inventory_In_000_Quin[Barely]} = 1000$$

UNITS: quintal

$$\begin{aligned} \text{Cereal_Inventory_In_000_Quin[Rice]}(t) &= \text{Cereal_Inventory_In_000_Quin[Rice]}(t - dt) + \\ &(\text{Delivery_of_cereals[cereal]} + \text{Comercial_Farm_Cereal_Delivery[cereal]} - \\ &\text{Consumption_Shipment_of_cereal[cereal]} - \text{Industry_Shipment[cereal]} - \text{Post_Harvest_Loss[cereal]}) * dt \end{aligned}$$

$$\text{INIT Cereal_Inventory_In_000_Quin[Rice]} = 0.1$$

UNITS: quintal

$$\begin{aligned} \text{Cereal_Inventory_In_000_Quin[Sorghum]}(t) &= \text{Cereal_Inventory_In_000_Quin[Sorghum]}(t - dt) + \\ &(\text{Delivery_of_cereals[cereal]} + \text{Comercial_Farm_Cereal_Delivery[cereal]} - \\ &\text{Consumption_Shipment_of_cereal[cereal]} - \text{Industry_Shipment[cereal]} - \text{Post_Harvest_Loss[cereal]}) * dt \end{aligned}$$

$$\text{INIT Cereal_Inventory_In_000_Quin[Sorghum]} = 2000$$

UNITS: quintal

$$\begin{aligned} \text{Cereal_Inventory_In_000_Quin[Millet]}(t) &= \text{Cereal_Inventory_In_000_Quin[Millet]}(t - dt) + \\ &(\text{Delivery_of_cereals[cereal]} + \text{Comercial_Farm_Cereal_Delivery[cereal]} - \\ &\text{Consumption_Shipment_of_cereal[cereal]} - \text{Industry_Shipment[cereal]} - \text{Post_Harvest_Loss[cereal]}) * dt \end{aligned}$$

$$\text{INIT Cereal_Inventory_In_000_Quin[Millet]} = 1000$$

UNITS: quintal

$Cereal_Inventory_In_000_Quin[Oats](t) = Cereal_Inventory_In_000_Quin[Oats](t - dt) +$
 $(Delivery_of_cereals[cereal] + Comercial_Farm_Cereal_Delivery[cereal] -$
 $Consumption_Shipment_of_cereal[cereal] - Industry_Shipment[cereal] - Post_Harvest_Loss[cereal]) * dt$

INIT $Cereal_Inventory_In_000_Quin[Oats] = 200$

UNITS: quintal

INFLOWS:

$Delivery_of_cereals[Tef] =$
 $Meher_seasonal_Production[Tef] + (HisEstimated_Belg_Cereal_Production[Tef] + Imported_Cereals[Tef]) * Distribution_of_Belg_and_imported_cereal$

UNITS: quintal/yr

$Delivery_of_cereals[Wheat] =$
 $Meher_seasonal_Production[Wheat] + (Imported_Cereals[Wheat] + HisEstimated_Belg_Cereal_Production[Wheat]) * Distribution_of_Belg_and_imported_cereal$

UNITS: quintal/yr

$Delivery_of_cereals[Maize] =$
 $Meher_seasonal_Production[Maize] + (HisEstimated_Belg_Cereal_Production[Maize] + Imported_Cereals[Maize]) * Distribution_of_Belg_and_imported_cereal$

UNITS: quintal/yr

$Delivery_of_cereals[Barely] =$
 $Meher_seasonal_Production[Barely] + (HisEstimated_Belg_Cereal_Production[Barely] + Imported_Cereals[Barely]) * Distribution_of_Belg_and_imported_cereal$

UNITS: quintal/yr

$Delivery_of_cereals[Rice] =$
 $Meher_seasonal_Production[Rice] + (HisEstimated_Belg_Cereal_Production[Rice] + Imported_Cereals[Rice]) * Distribution_of_Belg_and_imported_cereal$

UNITS: quintal/yr

$Delivery_of_cereals[Sorghum] =$
 $Meher_seasonal_Production[Sorghum] + (HisEstimated_Belg_Cereal_Production[Sorghum] + Imported_Cereals[Sorghum]) * Distribution_of_Belg_and_imported_cereal$

UNITS: quintal/yr

$Delivery_of_cereals[Millet] =$
 $Meher_seasonal_Production[Millet] + (HisEstimated_Belg_Cereal_Production[Millet] + Imported_Cereals[Millet]) * Distribution_of_Belg_and_imported_cereal$

UNITS: quintal/yr

$Delivery_of_cereals[Oats] =$
 $Meher_seasonal_Production[Oats] + (HisEstimated_Belg_Cereal_Production[Oats] + Imported_Cereals[Oats]) * Distribution_of_Belg_and_imported_cereal$

UNITS: quintal/yr

Comercial_Farm_Cereal_Delivery[Tef] = Industry__Shipment[Tef]

UNITS: quintal/yr

Comercial_Farm_Cereal_Delivery[Wheat] = Industry__Shipment[Wheat]

UNITS: quintal/yr

Comercial_Farm_Cereal_Delivery[Maize] = Industry__Shipment[Maize]

UNITS: quintal/yr

Comercial_Farm_Cereal_Delivery[Barely] = Industry__Shipment[Barely]

UNITS: quintal/yr

Comercial_Farm_Cereal_Delivery[Rice] = Industry__Shipment[Rice]

UNITS: quintal/yr

Comercial_Farm_Cereal_Delivery[Sorghum] = Industry__Shipment[Sorghum]

UNITS: quintal/yr

Comercial_Farm_Cereal_Delivery[Millet] = Industry__Shipment[Millet]

UNITS: quintal/yr

Comercial_Farm_Cereal_Delivery[Oats] = Industry__Shipment[Oats]

UNITS: quintal/yr

OUTFLOWS:

Consumption__Shipment__of_cereal[Tef] =

MIN(MAX(0,Cereal_Inventory__In_000_Quin[Tef]/Shipment__Adjme),Desired__Effective_Cereal__Consumption[Tef])

UNITS: quintal/yr

Consumption__Shipment__of_cereal[Wheat] =

MIN(MAX(0,Cereal_Inventory__In_000_Quin[Wheat]/Shipment__Adjme),Desired__Effective_Cereal__Consumption[Wheat])

UNITS: quintal/yr

Consumption__Shipment__of_cereal[Maize] =

MIN(MAX(0,Cereal_Inventory__In_000_Quin[Maize]/Shipment__Adjme),Desired__Effective_Cereal__Consumption[Maize])

UNITS: quintal/yr

Consumption__Shipment__of_cereal[Barely] =

MIN(MAX(0,Cereal_Inventory__In_000_Quin[Barely]/Shipment__Adjme),Desired__Effective_Cereal__Consumption[Barely])

UNITS: quintal/yr

$Consumption_Shipment_of_cereal[Rice] = MIN(MAX(0, Cereal_Inventory_In_000_Quin[Rice]/Shipment_Adjme), Desired_Effective_Cereal_Consumption[Rice])$

UNITS: quintal/yr

$Consumption_Shipment_of_cereal[Sorghum] = MIN(MAX(0, Cereal_Inventory_In_000_Quin[Sorghum]/Shipment_Adjme), Desired_Effective_Cereal_Consumption[Sorghum])$

UNITS: quintal/yr

$Consumption_Shipment_of_cereal[Millet] = MIN(MAX(0, Cereal_Inventory_In_000_Quin[Millet]/Shipment_Adjme + Cereal_Inventory_In_000_Quin[Teff]/Shipment_Adjme), Cereal_Inventory_In_000_Quin[Millet])$

UNITS: quintal/yr

$Consumption_Shipment_of_cereal[Oats] = MIN(MAX(Cereal_Inventory_In_000_Quin[Oats]/Shipment_Adjme, 0), Desired_Effective_Cereal_Consumption[Oats])$

UNITS: quintal/yr

$Industry_Shipment[Teff] = Cereal_Shipment_for_Industry_Processing[Teff]$

UNITS: quintal/yr

$Industry_Shipment[Wheat] = Cereal_Shipment_for_Industry_Processing[Wheat]$

UNITS: quintal/yr

$Industry_Shipment[Maize] = Cereal_Shipment_for_Industry_Processing[Maize]$

UNITS: quintal/yr

$Industry_Shipment[Barely] = Cereal_Shipment_for_Industry_Processing[Barely]$

UNITS: quintal/yr

$Industry_Shipment[Rice] = Cereal_Shipment_for_Industry_Processing[Rice]$

UNITS: quintal/yr

$Industry_Shipment[Sorghum] = Cereal_Shipment_for_Industry_Processing[Sorghum]$

UNITS: quintal/yr

$Industry_Shipment[Millet] = Cereal_Shipment_for_Industry_Processing[Millet]$

UNITS: quintal/yr

$Industry_Shipment[Oats] = Cereal_Shipment_for_Industry_Processing[Oats]$

UNITS: quintal/yr

$Post_Harvest_Loss[Teff] = IF((TIME < 2008) AND (TIME > 2014)) THEN (MAX(0, DELAY1(Meher_seasonal_Production[Teff] * Cereal_Loss_$

$_Fraction[Tef],0.5))ELSE(MAX(0,DELAY1(Meher_seasonal_Production[Tef]*Cereal_Loss_Fraction[Tef],0.5))+Cereal_Inventory_In_000_Quin[Tef]*Stock_adjustment_fraction)$

UNITS: quintal/yr

$Post_Harvest_Loss[Wheat] =$

$IF((TIME<2008)AND(TIME>2014))THEN(MAX(0,DELAY1(Meher_seasonal_Production[Wheat]*Cereal_Loss_Fraction[Wheat],0.5)))ELSE(MAX(0,DELAY1(Meher_seasonal_Production[Wheat]*Cereal_Loss_Fraction[Wheat],0.5))+Cereal_Inventory_In_000_Quin[Wheat]*Stock_adjustment_fraction)$

UNITS: quintal/yr

$Post_Harvest_Loss[Maize] =$

$IF((TIME<2008)AND(TIME>2014))THEN(MAX(0,DELAY1(Meher_seasonal_Production[Maize]*Cereal_Loss_Fraction[Maize],0.5)))ELSE(MAX(0,DELAY1(Meher_seasonal_Production[Maize]*Cereal_Loss_Fraction[Maize],0.5))+Cereal_Inventory_In_000_Quin[Maize]*Stock_adjustment_fraction)$

UNITS: quintal/yr

$Post_Harvest_Loss[Barely] =$

$IF((TIME<2008)AND(TIME>2014))THEN(MAX(0,DELAY1(Meher_seasonal_Production[Barely]*Cereal_Loss_Fraction[Barely],0.5)))ELSE(MAX(0,DELAY1(Meher_seasonal_Production[Barely]*Cereal_Loss_Fraction[Barely],0.5))+Cereal_Inventory_In_000_Quin[Barely]*Stock_adjustment_fraction)$

UNITS: quintal/yr

$Post_Harvest_Loss[Rice] =$

$IF((TIME<2008)AND(TIME>2014))THEN(MAX(0,DELAY1(Meher_seasonal_Production[Rice]*Cereal_Loss_Fraction[Rice],0.5)))ELSE(MAX(0,DELAY1(Meher_seasonal_Production[Rice]*Cereal_Loss_Fraction[Rice],0.5))+Cereal_Inventory_In_000_Quin[Rice]*Stock_adjustment_fraction)$

UNITS: quintal/yr

$Post_Harvest_Loss[Sorghum] =$

$IF((TIME<2008)AND(TIME>2014))THEN(MAX(0,DELAY1(Meher_seasonal_Production[Sorghum]*Cereal_Loss_Fraction[Sorghum],0.5)))ELSE(MAX(0,DELAY1(Meher_seasonal_Production[Sorghum]*Cereal_Loss_Fraction[Sorghum],0.5))+Cereal_Inventory_In_000_Quin[Sorghum]*Stock_adjustment_fraction)$

UNITS: quintal/yr

$Post_Harvest_Loss[Millet] =$

$IF((TIME<2008)AND(TIME>2014))THEN(MAX(0,DELAY1(Meher_seasonal_Production[Millet]*Cereal_Loss_Fraction[Millet],0.5)))ELSE(MAX(0,DELAY1(Meher_seasonal_Production[Millet]*Cereal_Loss_Fraction[Millet],0.5))+Cereal_Inventory_In_000_Quin[Millet]*Stock_adjustment_fraction)$

UNITS: quintal/yr

$Post_Harvest_Loss[Oats] =$

$MAX(0,DELAY1(Meher_seasonal_Production[Oats]*Cereal_Loss_Fraction[Oats],0.5))$

UNITS: quintal/yr

$Fallow_land_in_thousand_Ha(t) = Fallow_land_in_thousand_Ha(t - dt) + (Conversion_of_Cultivated_Area_to_Temporary_fallow - Conversion_of_Temporary_Fallow_toCereal_Cultivation_area) * dt$

INIT $Fallow_land_in_thousand_Ha = 439.94$

UNITS: hectare

DOCUMENT: Ha

INFLOWS:

$Conversion_of_Cultivated_Area_to_Temporary_fallow = Land_Degradation_series.Becoming_fallow_Total$

UNITS: hectares/yr

OUTFLOWS:

$Conversion_of_Temporary_Fallow_toCereal_Cultivation_area =$
 $Land_Degradation_series.Fallow_to_Cultivation_Total$

UNITS: hectares/yr

$Non_Productive_Land_in_thousand_Ha(t) = Non_Productive_Land_in_thousand_Ha(t - dt) +$
 $(Degradation_Rate - Conversion_of_severely_Fallowto_Arable) * dt$

INIT $Non_Productive_Land_in_thousand_Ha = 2000$

UNITS: hectare

INFLOWS:

$Degradation_Rate = Land_Degradation_series.Becoming_non_Fetil_Land$

UNITS: hectares/yr

OUTFLOWS:

$Conversion_of_severely_Fallowto_Arable = Rehablitable_Land/Time_to_rehablitate$

UNITS: hectares/yr

$Potential_Cultivable_Area_in_thousand_Ha(t) = Potential_Cultivable_Area_in_thousand_Ha(t - dt) +$
 $(Conversion_of_severely_Fallowto_Arable - Other_Conversion_Rate -$
 $Conversion_Rate_of_Arable_to_cultivation) * dt$

INIT $Potential_Cultivable_Area_in_thousand_Ha = 35945$

UNITS: hectare

INFLOWS:

$Conversion_of_severely_Fallowto_Arable = Rehablitable_Land/Time_to_rehablitate$

UNITS: hectares/yr

OUTFLOWS:

$Other_Conversion_Rate = (1 - Arable_cereal_fraction) * Conversion_Rate_of_Arable_to_cultivation$

UNITS: hectares/yr

$Conversion_Rate_of_Arable_to_cultivation =$
 $MIN(Change_of_Arable_to_Cereal_Cultivation, Cereal_Cultivation_Area_Adjustment)$

UNITS: hectares/yr

$$\text{Producer_Price_per_000_Quin[Tef]}(t) = \text{Producer_Price_per_000_Quin[Tef]}(t - dt) + (\text{Change_in_Producer_Price[cereal]}) * dt$$

$$\text{INIT Producer_Price_per_000_Quin[Tef]} = 200000$$

UNITS: birr/quintal

$$\text{Producer_Price_per_000_Quin[Wheat]}(t) = \text{Producer_Price_per_000_Quin[Wheat]}(t - dt) + (\text{Change_in_Producer_Price[cereal]}) * dt$$

$$\text{INIT Producer_Price_per_000_Quin[Wheat]} = 156000$$

UNITS: birr/quintal

$$\text{Producer_Price_per_000_Quin[Maize]}(t) = \text{Producer_Price_per_000_Quin[Maize]}(t - dt) + (\text{Change_in_Producer_Price[cereal]}) * dt$$

$$\text{INIT Producer_Price_per_000_Quin[Maize]} = 95000$$

UNITS: birr/quintal

$$\text{Producer_Price_per_000_Quin[Barely]}(t) = \text{Producer_Price_per_000_Quin[Barely]}(t - dt) + (\text{Change_in_Producer_Price[cereal]}) * dt$$

$$\text{INIT Producer_Price_per_000_Quin[Barely]} = 134000$$

UNITS: birr/quintal

$$\text{Producer_Price_per_000_Quin[Rice]}(t) = \text{Producer_Price_per_000_Quin[Rice]}(t - dt) + (\text{Change_in_Producer_Price[cereal]}) * dt$$

$$\text{INIT Producer_Price_per_000_Quin[Rice]} = 410220$$

UNITS: birr/quintal

$$\text{Producer_Price_per_000_Quin[Sorghum]}(t) = \text{Producer_Price_per_000_Quin[Sorghum]}(t - dt) + (\text{Change_in_Producer_Price[cereal]}) * dt$$

$$\text{INIT Producer_Price_per_000_Quin[Sorghum]} = 119000$$

UNITS: birr/quintal

$$\text{Producer_Price_per_000_Quin[Millet]}(t) = \text{Producer_Price_per_000_Quin[Millet]}(t - dt) + (\text{Change_in_Producer_Price[cereal]}) * dt$$

$$\text{INIT Producer_Price_per_000_Quin[Millet]} = 133000$$

UNITS: birr/quintal

$$\text{Producer_Price_per_000_Quin[Oats]}(t) = \text{Producer_Price_per_000_Quin[Oats]}(t - dt) + (\text{Change_in_Producer_Price[cereal]}) * dt$$

$$\text{INIT Producer_Price_per_000_Quin[Oats]} = 137000$$

UNITS: birr/quintal

INFLOWS:

$Change_in_Producer_Price[Tef] = (Indicated_Producer_Price[Tef] - Producer_Price_per_000_Quin[Tef]) / Price_Adjustment_Time$

UNITS: birr/quintal-yr

$Change_in_Producer_Price[Wheat] = (Indicated_Producer_Price[Wheat] - Producer_Price_per_000_Quin[Wheat]) / Price_Adjustment_Time$

UNITS: birr/quintal-yr

$Change_in_Producer_Price[Maize] = (Indicated_Producer_Price[Maize] - Producer_Price_per_000_Quin[Maize]) / Price_Adjustment_Time$

UNITS: birr/quintal-yr

$Change_in_Producer_Price[Barely] = (Indicated_Producer_Price[Barely] - Producer_Price_per_000_Quin[Barely]) / Price_Adjustment_Time$

UNITS: birr/quintal-yr

$Change_in_Producer_Price[Rice] = (Indicated_Producer_Price[Rice] - Producer_Price_per_000_Quin[Rice]) / Price_Adjustment_Time$

UNITS: birr/quintal-yr

$Change_in_Producer_Price[Sorghum] = (Indicated_Producer_Price[Sorghum] - Producer_Price_per_000_Quin[Sorghum]) / Price_Adjustment_Time$

UNITS: birr/quintal-yr

$Change_in_Producer_Price[Millet] = (Indicated_Producer_Price[Millet] - Producer_Price_per_000_Quin[Millet]) / Price_Adjustment_Time$

UNITS: birr/quintal-yr

$Change_in_Producer_Price[Oats] = (Indicated_Producer_Price[Oats] - Producer_Price_per_000_Quin[Oats]) / Price_Adjustment_Time$

UNITS: birr/quintal-yr

$Alawable_Fraction = 0.0087$

UNITS: per year (1/yr)

$All_cereal_Yearly_Available[Tef] = Imported_Cereals[Tef] + Historical_Cereal_Production1[Tef] + HisEstimated_Belg_Cereal_Production[Tef]$

$All_cereal_Yearly_Available[Wheat] = Imported_Cereals[Wheat] + Historical_Cereal_Production1[Wheat] + HisEstimated_Belg_Cereal_Production[Wheat]$

$All_cereal_Yearly_Available[Maize] = Imported_Cereals[Maize] + Historical_Cereal_Production1[Maize] + HisEstimated_Belg_Cereal_Production[Maize]$

$All_cereal_Yearly_Available[Barely] = Imported_Cereals[Barely] + Historical_Cereal_Production1[Barely] + HisEstimated_Belg_Cereal_Production[Barely]$

*All_cereal__Yearly_Available[Rice] =
Imported_Cereals[Rice]+Historical__Cereal_Production1[Rice]+HisEstimated_Belg_Cereal_Production*
]

*All_cereal__Yearly_Available[Sorghum] =
Imported_Cereals[Sorghum]+Historical__Cereal_Production1[Sorghum]+HisEstimated_Belg_Cereal_Product*
ion[Sorghum]

*All_cereal__Yearly_Available[Millet] =
Imported_Cereals[Millet]+Historical__Cereal_Production1[Millet]+HisEstimated_Belg_Cereal_Production[*
Millet]

*All_cereal__Yearly_Available[Oats] =
Imported_Cereals[Oats]+Historical__Cereal_Production1[Oats]+HisEstimated_Belg_Cereal_Production[Oat*
s]

*Annual_Desired_net_Kcal_Consumption_PC =
Desired_Net_Kcal_of_cereal_per_day_PC*Nmber_of_days__in_a_Year*

UNITS: kilocalorie/year-person

Annual_Inflation_Rate = GRAPH(TIME)

(1995, 0.00), (1996, -0.198), (1997, -0.009), (1998, 0.154), (1999, 0.107), (2000, -0.032), (2001, -0.235), (2002,
-0.163), (2003, 0.4), (2003, 0.056), (2004, 0.123), (2005, 0.144), (2006, 0.44), (2007, 0.381), (2008, -0.083),
(2009, -0.091), (2010, 0.03), (2011, 0.03)

Annual_Inflation__Rate_Producer_Price = GRAPH(TIME)

(1995, 0.00), (1996, -0.198), (1997, -0.0086), (1998, 0.154), (1999, 0.107), (2000, -0.032), (2001, -0.235), (2002,
-0.163), (2003, 0.4), (2003, 0.056), (2004, 0.123), (2005, 0.144), (2006, 0.44), (2007, 0.381), (2008, -0.083),
(2009, -0.0909), (2010, 0.03), (2011, 0.03)

UNITS: Unitless

*Annual_PC__cereal_expenditure_share =
IF(TIME<2010)THEN(Average_weighted_cereal_share_of_expenditure)ELSE(Forcasted_cereareal_share_of_*
expenditure)

*Annual_PC__expenditure =
IF(TIME<2010)THEN(Historical__Annual_Avarage_PC__Expenditure)ELSE(Forcasted_PC_Expenditure_for_*
cereal_consumption)

UNITS: birr/person-year

Annual_Producer__Price_Barely = GRAPH(TIME)

(1995, 134000), (1996, 121000), (1997, 112000), (1998, 123000), (1999, 148700), (2000, 143500), (2001,
112800), (2002, 89000), (2003, 145500), (2004, 145300), (2005, 168200), (2006, 175000), (2007, 316000),
(2008, 432000), (2009, 413000), (2010, 394000)

Annual_Producer__Price_Maize = GRAPH(TIME)

(1995, 95000), (1996, 71000), (1997, 76000), (1998, 91000), (1999, 97000), (2000, 98000), (2001, 67000),
(2002, 57000), (2003, 108800), (2004, 101500), (2005, 125300), (2006, 120000), (2007, 241000), (2008,
336000), (2009, 290000), (2010, 244000)

Annual_Producer__Price_Millet = GRAPH(TIME)

(1995, 133000), (1996, 96000), (1997, 95000), (1998, 117000), (1999, 12000), (2000, 119000), (2001, 95000), (2002, 85000), (2003, 114200), (2004, 142600), (2005, 147200), (2006, 164000), (2007, 295000), (2008, 443000), (2009, 399000), (2010, 355000)

Annual_Producer__Price_Oats = GRAPH(TIME)

(1995, 137000), (1996, 115000), (1997, 108000), (1998, 116000), (1999, 133000), (2000, 111000), (2001, 106000), (2002, 78000), (2003, 129000), (2004, 167700), (2005, 166700), (2006, 207000), (2007, 275000), (2008, 433000), (2009, 410000), (2010, 387000)

Annual_Producer__Price_Rice = GRAPH(TIME)

(1995, 160220), (1996, 120000), (1997, 128490), (1998, 153850), (1999, 164000), (2000, 165690), (2001, 113280), (2002, 96370), (2003, 96030), (2004, 89590), (2005, 110600), (2006, 193000), (2007, 383000), (2008, 705000), (2009, 622950), (2010, 600900)

Annual_Producer__Price_Sorghum = GRAPH(TIME)

(1995, 119000), (1996, 90000), (1997, 94000), (1998, 110000), (1999, 108800), (2000, 116800), (2001, 85500), (2002, 77500), (2003, 143300), (2004, 138600), (2005, 163400), (2006, 151000), (2007, 309000), (2008, 428700), (2009, 379250), (2010, 330000)

Annual_Producer__Price_Tef = 200

Annual_Producer__Price_Wheat = GRAPH(TIME)

(1995, 156000), (1996, 136000), (1997, 129000), (1998, 146000), (1999, 174700), (2000, 163700), (2001, 122300), (2002, 104300), (2003, 153500), (2004, 154900), (2005, 175100), (2006, 199000), (2007, 353600), (2008, 506700), (2009, 466350), (2010, 426000)

Annual__Average_PC__Expenditure_End = Annual_PC__expenditure(1-Percentage_effect_of_productivity_on_PC_expenditure)+Annual_PC__expenditure*Effect_of_yeild_and_producer_price_on_consumption_Expenditure*Percentage_effect_of_productivity_on_PC_expenditure*

UNITS: birr/person-year

Arable_cereal_fraction = 0.8

UNITS: Unitless

Average_Cereal_Price =

Historical_Annual__producer_Price_Cereal[Tef]+Historical_Annual__producer_Price_Cereal[Wheat]+Historical_Annual__producer_Price_Cereal[Maize]+Historical_Annual__producer_Price_Cereal[Barely]+Historical_Annual__producer_Price_Cereal[Rice]+Historical_Annual__producer_Price_Cereal[Sorghum]+Historical_Annual__producer_Price_Cereal[Millet]+Historical_Annual__producer_Price_Cereal[Oats]

Average_Fuel__price_USD = (Diesel_Price_USD+Gasoline_Price_USD)/2

UNITS: usd per litter

Average_PC_Barely_Consumption_per_month_in_Gm = 1454.08

Average_PC_Barely_Consumption_per_month_in_Gm_2 = 620

*Average_PC_Budget_of_Cereal_Consumption_Per_Year = Annual_PC_cereal_expenditure_share*Annual_Average_PC_Expenditure_End*

UNITS: birr/person-year

Average_PC_Cereal_Consumption_Unit_per_month_in_Gm[Tef] = Average_PC_Tef_Consumption_per_month_in_Gm

Average_PC_Cereal_Consumption_Unit_per_month_in_Gm[Wheat] = Average_PC_wheat_Consumption_per_month_in_Gm

Average_PC_Cereal_Consumption_Unit_per_month_in_Gm[Maize] = Average_PC_Maize_Consumption_per_month_in_Gm

Average_PC_Cereal_Consumption_Unit_per_month_in_Gm[Barely] = Average_PC_Barely_Consumption_per_month_in_Gm

Average_PC_Cereal_Consumption_Unit_per_month_in_Gm[Rice] = Average_PC_Rice_Consumption_per_month_in_Gm

Average_PC_Cereal_Consumption_Unit_per_month_in_Gm[Sorghum] = Average_PC_Sorghum_Consumption_per_month_in_Gm

Average_PC_Cereal_Consumption_Unit_per_month_in_Gm[Millet] = Average_PC_Millet_per_month_in_Gm

Average_PC_Cereal_Consumption_Unit_per_month_in_Gm[Oats] = Average_PC_Oats_Consumption_per_month_in_Gm

Average_PC_Maize_Consumption_per_month_in_Gm = 3257.42

Average_PC_Maize_Consumption_per_month_in_Gm_2 = 3000

Average_PC_Millet_per_month_in_Gm = 240.83

Average_PC_Millet_per_month_in_Gm_2 = 346.83

Average_PC_Oats_Consumption_per_month_in_Gm = 61.33

Average_PC_Oats_Consumption_per_month_in_Gm_2 = 61.33

Average_PC_Rice_Consumption_per_month_in_Gm = 540.8

Average_PC_Rice_Consumption_per_month_in_Gm_2 = 14

Average_PC_Sorghum_Consumption_per_month_in_Gm = 2250.5

Average_PC_Sorghum_Consumption_per_month_in_Gm_2 = 1650.5

Average_PC_Tef_Consumption_per_month_in_Gm = 2700.67

Average_PC_Tef_Consumption_per_month_in_Gm_2 = 2400

Average_PC_wheat_Consumption_per_month_in_Gm = 2600.42

Average_PC_wheat_Consumption_per_month_in_Gm_2 = 1687.42

Average_weighted_cereal_share_of_expenditure = GRAPH(TIME)

(1995, 0.19), (2000, 0.24), (2005, 0.21), (2010, 0.19)

UNITS: Unitless

Average___Cultivation_Area_PC = 0.153

UNITS: hectare per person

Average___Exchange_rate = GRAPH(TIME)

(1995, 5.71), (1996, 5.83), (1997, 6.50), (1998, 6.97), (1999, 7.81), (2000, 8.08), (2001, 8.20), (2002, 8.06), (2003, 8.18), (2004, 8.34), (2005, 8.54), (2006, 8.42), (2007, 8.75), (2008, 9.47), (2009, 11.5), (2010, 14.2)

UNITS: birr/usd

BA =

InitialEstimated_Expenditure_Share_of__Cereals_from_total_Budget[Barely]*Relative_Share_of_Cereals[Bar
ely]

Barely_for__industrial_Processing = GRAPH(TIME)

(1995, 155), (1996, 159), (1997, 178), (1998, 92.0), (1999, 164), (2000, 111), (2001, 184), (2002, 182), (2003, 206), (2004, 244), (2005, 230), (2006, 250), (2007, 270), (2008, 280), (2009, 292), (2010, 300)

Barely_Kcal_share = GRAPH(TIME)

(2014, 0.1), (2018, 0.1), (2021, 0.1), (2025, 0.1)

Barely__net_import = GRAPH(TIME)

(1995, 20.0), (1996, 90.0), (1997, 90.0), (1998, 50.0), (1999, 140), (2000, 130), (2001, 150), (2002, 80.0), (2003, 80.0), (2004, 80.0), (2005, 160), (2006, 390), (2007, 460), (2008, 430), (2009, 320), (2010, 300)

Barley___Ecpenditure_Share = GRAPH(TIME)

(1995, 0.06), (1996, 0.05), (1997, 0.07), (1998, 0.06), (1999, 0.06), (2000, 0.06), (2001, 0.06), (2002, 0.06), (2003, 0.07), (2004, 0.08), (2005, 0.07), (2006, 0.07), (2007, 0.06), (2008, 0.08), (2009, 0.08), (2010, 0.075)

Bedget_Alloted_for_cereal__Consumption_per_year[Tef] =

Comulative_Budget_of_Cereal_consumption_per_year*Estimated_Cereal_Expenditure__share[Tef]

UNITS: birr/year

Bedget_Alloted_for_cereal__Consumption_per_year[Wheat] =

Comulative_Budget_of_Cereal_consumption_per_year*Estimated_Cereal_Expenditure__share[Wheat]

UNITS: birr/year

Bedget_Alloted_for_cereal__Consumption_per_year[Maize] =

Comulative_Budget_of_Cereal_consumption_per_year*Estimated_Cereal_Expenditure__share[Maize]

UNITS: birr/year

Bedget_Alloted_for_cereal__Consumption_per_year[Barely] =

Comulative_Budget_of_Cereal_consumption_per_year*Estimated_Cereal_Expenditure__share[Barely]

UNITS: birr/year

$Budget_Alloted_for_cereal_Consumption_per_year[Rice] =$
 $Comulative_Budget_of_Cereal_consumption_per_year * Estimated_Cereal_Expenditure_share[Rice]$

UNITS: birr/year

$Budget_Alloted_for_cereal_Consumption_per_year[Sorghum] =$
 $Comulative_Budget_of_Cereal_consumption_per_year * Estimated_Cereal_Expenditure_share[Sorghum]$

UNITS: birr/year

$Budget_Alloted_for_cereal_Consumption_per_year[Millet] =$
 $Comulative_Budget_of_Cereal_consumption_per_year * Estimated_Cereal_Expenditure_share[Millet]$

UNITS: birr/year

$Budget_Alloted_for_cereal_Consumption_per_year[Oats] =$
 $Comulative_Budget_of_Cereal_consumption_per_year * Estimated_Cereal_Expenditure_share[Oats]$

UNITS: birr/year

$Budget_allcated_For_Input[Fertilizer] =$
 $Percieved_Investments_For_Inputs * Share_of_investment_for_input[Fertilizer]$

UNITS: birr/year

$Budget_allcated_For_Input[Improved_Seed] =$
 $Percieved_Investments_For_Inputs * Share_of_investment_for_input[Improved_Seed]$

UNITS: birr/year

$Calorie_per_100gm_Barley_grain = 371.55$

$Calorie_per_100gm_Millet_grain = 350.5$

$Calorie_per_100gm_Oat_grain = 361.6$

$Calorie_per_100gm_Tef_flour = 355.8$

$Calorie_per_100gm_Maize_grain = 361.105$

$Calorie_per_100gm_Rice_grain = 357.2$

$Calorie_per_100gm_Sorgum_grain = 369.85$

$Calorie_per_100_gm_wheat_grain = 358.93$

$Cereal_Cultivation_Area_Gap = (1 - Policy3_activated) * (MAX(0, Desired_Cereal_Cultivated_area - Cereal_Cultivated_Area_in_thousand_Ha)) + Policy3_activated * MAX(0, MIN(Yield_Sector.Desired_Cultivation_Area, Desired_Cereal_Cultivated_area) - Cereal_Cultivated_Area_in_thousand_Ha)$

UNITS: hectare

$Cereal_Cultivation_Area_Adjustment =$
 $Cereal_Cultivation_Area_Gap / Cultivation_Area_adjustment_Time + (Total_fallowed_land_per_year - Conversion_of_Temporary_Fallow_toCereal_Cultivation_area)$

UNITS: hectares/year

Cereal_Extraction_rate[Tef] = 0.85

UNITS: Unitless

Cereal_Extraction_rate[Wheat] = 0.8

UNITS: Unitless

Cereal_Extraction_rate[Maize] = 0.75

UNITS: Unitless

Cereal_Extraction_rate[Barely] = 0.7

UNITS: Unitless

Cereal_Extraction_rate[Rice] = 0.89

UNITS: Unitless

Cereal_Extraction_rate[Sorghum] = 0.8

UNITS: Unitless

Cereal_Extraction_rate[Millet] = 0.8

UNITS: Unitless

Cereal_Extraction_rate[Oats] = 0.8

UNITS: Unitless

*Cereal_Import__Distribution[Tef] = Imported_Cereals[Tef]*Distribution_of_Belg_and_imported_cereal*

*Cereal_Import__Distribution[Wheat] = Imported_Cereals[Wheat]*Distribution_of_Belg_and_imported_cereal*

*Cereal_Import__Distribution[Maize] = Imported_Cereals[Maize]*Distribution_of_Belg_and_imported_cereal*

*Cereal_Import__Distribution[Barely] = Imported_Cereals[Barely]*Distribution_of_Belg_and_imported_cereal*

*Cereal_Import__Distribution[Rice] = Imported_Cereals[Rice]*Distribution_of_Belg_and_imported_cereal*

*Cereal_Import__Distribution[Sorghum] =
Imported_Cereals[Sorghum]*Distribution_of_Belg_and_imported_cereal*

*Cereal_Import__Distribution[Millet] = Imported_Cereals[Millet]*Distribution_of_Belg_and_imported_cereal*

*Cereal_Import__Distribution[Oats] = Imported_Cereals[Oats]*Distribution_of_Belg_and_imported_cereal*

Cereal_Loss__Fraction[Tef] = 0.1

UNITS: Unitless

Cereal_Loss__Fraction[Wheat] = 0.15

UNITS: Unitless

Cereal_Loss__Fraction[Maize] = 0.18

UNITS: Unitless

Cereal_Loss__Fraction[Barely] = 0.11

UNITS: Unitless

Cereal_Loss__Fraction[Rice] = 0.05

UNITS: Unitless

Cereal_Loss__Fraction[Sorghum] = 0.1

UNITS: Unitless

Cereal_Loss__Fraction[Millet] = 0.9

UNITS: Unitless

Cereal_Loss__Fraction[Oats] = 0.11

UNITS: Unitless

Cereal_price_1995_per_Gm[Tef] = 0.2

Cereal_price_1995_per_Gm[Wheat] = 0.156

Cereal_price_1995_per_Gm[Maize] = 0.095

Cereal_price_1995_per_Gm[Barely] = 0.134

Cereal_price_1995_per_Gm[Rice] = 0.16

Cereal_price_1995_per_Gm[Sorghum] = 0.119

Cereal_price_1995_per_Gm[Millet] = 0.133

Cereal_price_1995_per_Gm[Oats] = 0.137

Cereal_Shipment_for_Industry_Processing[Tef] = Tef_for_Industrial_Processing

UNITS: quintal/year

Cereal_Shipment_for_Industry_Processing[Wheat] = Wheat_for___Industrial_Processing

UNITS: quintal/year

Cereal_Shipment_for_Industry_Processing[Maize] = Maize_for__Industrial_Processing

UNITS: quintal/year

Cereal_Shipment_for_Industry_Processing[Barely] = Barely_for__industrial_Processing

UNITS: quintal/year

Cereal_Shipment_for_Industry_Processing[Rice] = Rice__for__Industrial_Processing

UNITS: quintal/year

Cereal_Shipment_for_Industry_Processing[Sorghum] = Sorghum_for_industrial_Processing

UNITS: quintal/year

Cereal_Shipment_for_Industry_Processing[Millet] = Millet_for__Industrial_Processing

UNITS: quintal/year

Cereal_Shipment_for_Industry_Processing[Oats] = Oats_for__Industrial_Processing

UNITS: quintal/year

*Change_of_Arable_to_Cereal_Cultivation = Alawable_Fraction*Potential_Cultivable_Area_in_thousand_Ha*

Comulative_Budget_of_Cereal_consumption_per_year =

*Population.Total__Population*Average_PC_Budget_of__Cereal_Consumption_Per_Year*

UNITS: birr/year

Comulative_Desired_100_gram__Whole_grain_per_year[Tef] =

Comulative_Desired_Edible_hundred_gram_of_cereal_per_year[Tef](1+Fraction_lost_as_of_food_preparation[Tef])*

UNITS: gram/year

Comulative_Desired_100_gram__Whole_grain_per_year[Wheat] =

Comulative_Desired_Edible_hundred_gram_of_cereal_per_year[Wheat](1+Fraction_lost_as_of_food_preparation[Wheat])*

UNITS: gram/year

Comulative_Desired_100_gram__Whole_grain_per_year[Maize] =

Comulative_Desired_Edible_hundred_gram_of_cereal_per_year[Maize](1+Fraction_lost_as_of_food_preparation[Maize])*

UNITS: gram/year

Comulative_Desired_100_gram__Whole_grain_per_year[Barely] =

Comulative_Desired_Edible_hundred_gram_of_cereal_per_year[Barely](1+Fraction_lost_as_of_food_preparation[Barely])*

UNITS: gram/year

Comulative_Desired_100_gram__Whole_grain_per_year[Rice] =

Comulative_Desired_Edible_hundred_gram_of_cereal_per_year[Rice](1+Fraction_lost_as_of_food_preparation[Rice])*

UNITS: gram/year

Comulative_Desired_100_gram__Whole_grain_per_year[Sorghum] =

Comulative_Desired_Edible_hundred_gram_of_cereal_per_year[Sorghum](1+Fraction_lost_as_of_food_preparation[Sorghum])*

UNITS: gram/year

Comulative_Desired_100_gram__Whole_grain_per_year[Millet] =

Comulative_Desired_Edible_hundred_gram_of_cereal_per_year[Millet](1+Fraction_lost_as_of_food_preparation[Millet])*

UNITS: gram/year

$Comulative_Desired_100_gram_Whole_grain_per_year[Oats] =$
 $Comulative_Desired_Edible_hundred_gram_of_cereal_per_year[Oats]*(1+Fraction_lost_as_of_food_preparation[Oats])$

UNITS: gram/year

$Comulative_Desired_Cereal_Calories_per_year =$
 $Kcal_per_100Gm_Edible_portion_of_Cereal[Tef]*Comulative_Desired_Edible_hundred_gram_of_cereal_per_year[Tef]+Kcal_per_100Gm_Edible_portion_of_Cereal[Wheat]*Comulative_Desired_Edible_hundred_gram_of_cereal_per_year[Wheat]+Kcal_per_100Gm_Edible_portion_of_Cereal[Maize]*Comulative_Desired_Edible_hundred_gram_of_cereal_per_year[Maize]+Kcal_per_100Gm_Edible_portion_of_Cereal[Barely]*Comulative_Desired_Edible_hundred_gram_of_cereal_per_year[Barely]+Kcal_per_100Gm_Edible_portion_of_Cereal[Rice]*Comulative_Desired_Edible_hundred_gram_of_cereal_per_year[Rice]+Kcal_per_100Gm_Edible_portion_of_Cereal[Sorghum]*Comulative_Desired_Edible_hundred_gram_of_cereal_per_year[Sorghum]+Kcal_per_100Gm_Edible_portion_of_Cereal[Millet]*Comulative_Desired_Edible_hundred_gram_of_cereal_per_year[Millet]+Kcal_per_100Gm_Edible_portion_of_Cereal[Oats]*Comulative_Desired_Edible_hundred_gram_of_cereal_per_year[Oats]$

UNITS: kilocalorie/year

$Comulative_Desired_Edible_hundred_gram_of_cereal_per_year[Tef] =$
 $Population.Total_Population*Desired_Edible_100_gram_of_Cerealsper_Year_PC[Tef]$

UNITS: gram/year

$Comulative_Desired_Edible_hundred_gram_of_cereal_per_year[Wheat] =$
 $Population.Total_Population*Desired_Edible_100_gram_of_Cerealsper_Year_PC[Wheat]$

UNITS: gram/year

$Comulative_Desired_Edible_hundred_gram_of_cereal_per_year[Maize] =$
 $Population.Total_Population*Desired_Edible_100_gram_of_Cerealsper_Year_PC[Maize]$

UNITS: gram/year

$Comulative_Desired_Edible_hundred_gram_of_cereal_per_year[Barely] =$
 $Population.Total_Population*Desired_Edible_100_gram_of_Cerealsper_Year_PC[Barely]$

UNITS: gram/year

$Comulative_Desired_Edible_hundred_gram_of_cereal_per_year[Rice] =$
 $Population.Total_Population*Desired_Edible_100_gram_of_Cerealsper_Year_PC[Rice]$

UNITS: gram/year

$Comulative_Desired_Edible_hundred_gram_of_cereal_per_year[Sorghum] =$
 $Population.Total_Population*Desired_Edible_100_gram_of_Cerealsper_Year_PC[Sorghum]$

UNITS: gram/year

$Comulative_Desired_Edible_hundred_gram_of_cereal_per_year[Millet] =$
 $Population.Total_Population*Desired_Edible_100_gram_of_Cerealsper_Year_PC[Millet]$

UNITS: gram/year

$Comulative_Desired_Edible_hundred_gram_of_cereal_per_year[Oats] =$
 $Population.Total_Population*Desired_Edible_100_gram_of_Cerealsper_Year_PC[Oats]$

UNITS: gram/year

$Comulative_Desired_Kg_of_Cereals_per_Year[Tef] =$
 $Comulative_Desired_100_gram_Whole_grain_per_year[Tef]/Hundred_grams_per_Kg$

UNITS: kilogram/year

$Comulative_Desired_Kg_of_Cereals_per_Year[Wheat] =$
 $Comulative_Desired_100_gram_Whole_grain_per_year[Wheat]/Hundred_grams_per_Kg$

UNITS: kilogram/year

$Comulative_Desired_Kg_of_Cereals_per_Year[Maize] =$
 $Comulative_Desired_100_gram_Whole_grain_per_year[Maize]/Hundred_grams_per_Kg$

UNITS: kilogram/year

$Comulative_Desired_Kg_of_Cereals_per_Year[Barely] =$
 $Comulative_Desired_100_gram_Whole_grain_per_year[Barely]/Hundred_grams_per_Kg$

UNITS: kilogram/year

$Comulative_Desired_Kg_of_Cereals_per_Year[Rice] =$
 $Comulative_Desired_100_gram_Whole_grain_per_year[Rice]/Hundred_grams_per_Kg$

UNITS: kilogram/year

$Comulative_Desired_Kg_of_Cereals_per_Year[Sorghum] =$
 $Comulative_Desired_100_gram_Whole_grain_per_year[Sorghum]/Hundred_grams_per_Kg$

UNITS: kilogram/year

$Comulative_Desired_Kg_of_Cereals_per_Year[Millet] =$
 $Comulative_Desired_100_gram_Whole_grain_per_year[Millet]/Hundred_grams_per_Kg$

UNITS: kilogram/year

$Comulative_Desired_Kg_of_Cereals_per_Year[Oats] =$
 $Comulative_Desired_100_gram_Whole_grain_per_year[Oats]/Hundred_grams_per_Kg$

UNITS: kilogram/year

$Consumed_Effective_edible_cereals_in_hundred_grams[Tef] =$
 $Consumed_Effective_Cereal_in_Hundred_grams[Tef]*Cereal_Extraction_rate[Tef]$

UNITS: gram/year

$Consumed_Effective_edible_cereals_in_hundred_grams[Wheat] =$
 $Consumed_Effective_Cereal_in_Hundred_grams[Wheat]*Cereal_Extraction_rate[Wheat]$

UNITS: gram/year

$Consumed_Effective_edible_cereals_in_hundred_grams[Maize] =$
 $Consumed_Effective_Cereal_in_Hundred_grams[Maize]*Cereal_Extraction_rate[Maize]$

UNITS: gram/year

$Consumed_Effective_edible_cereals_in_hundred_grams[Barely] =$
 $Consumed_Effective_Cereal_in_Hundred_grams[Barely]*Cereal_Extraction_rate[Barely]$

UNITS: gram/year

$Consumed_Effective_edible_cereals_in_hundred_grams[Rice] =$
 $Consumed_Effective_Cereal_in_Hundred_grams[Rice]*Cereal_Extraction_rate[Rice]$

UNITS: gram/year

$Consumed_Effective_edible_cereals_in_hundred_grams[Sorghum] =$
 $Consumed_Effective_Cereal_in_Hundred_grams[Sorghum]*Cereal_Extraction_rate[Sorghum]$

UNITS: gram/year

$Consumed_Effective_edible_cereals_in_hundred_grams[Millet] =$
 $Consumed_Effective_Cereal_in_Hundred_grams[Millet]*Cereal_Extraction_rate[Millet]$

UNITS: gram/year

$Consumed_Effective_edible_cereals_in_hundred_grams[Oats] =$
 $Consumed_Effective_Cereal_in_Hundred_grams[Oats]*Cereal_Extraction_rate[Oats]$

UNITS: gram/year

$Consumed_Effective_Cereal_in_Hundred_grams[Tef] =$
 $MIN(Desired_Effective_Cereal_Consumption[Tef]*Hundred_grams_per_Kg*KG_in_thousand_Quintals,$
 $Consumption_Shipment_of_cereal[Tef]*Hundred_grams_per_Kg*KG_in_thousand_Quintals)$

UNITS: gram/year

$Consumed_Effective_Cereal_in_Hundred_grams[Wheat] =$
 $MIN(Desired_Effective_Cereal_Consumption[Wheat]*Hundred_grams_per_Kg*KG_in_thousand_Quintals,$
 $Consumption_Shipment_of_cereal[Wheat]*Hundred_grams_per_Kg*KG_in_thousand_Quintals)$

UNITS: gram/year

$Consumed_Effective_Cereal_in_Hundred_grams[Maize] =$
 $MIN(Desired_Effective_Cereal_Consumption[Maize]*Hundred_grams_per_Kg*KG_in_thousand_Quintals,$
 $Consumption_Shipment_of_cereal[Maize]*Hundred_grams_per_Kg*KG_in_thousand_Quintals)$

UNITS: gram/year

$Consumed_Effective_Cereal_in_Hundred_grams[Barely] =$
 $MIN(Desired_Effective_Cereal_Consumption[Barely]*Hundred_grams_per_Kg*KG_in_thousand_Quintals,$
 $Consumption_Shipment_of_cereal[Barely]*Hundred_grams_per_Kg*KG_in_thousand_Quintals)$

UNITS: gram/year

$Consumed_Effective_Cereal_in_Hundred_grams[Rice] =$
 $MIN(Desired_Effective_Cereal_Consumption[Rice]*Hundred_grams_per_Kg*KG_in_thousand_Quintals,$
 $Consumption_Shipment_of_cereal[Rice]*Hundred_grams_per_Kg*KG_in_thousand_Quintals)$

UNITS: gram/year

$Consumed_Effective_Cereal_in_Hundred_grams[Sorghum] =$
 $MIN(Desired_Effective_Cereal_Consumption[Sorghum]*Hundred_grams_per_Kg*KG_in_thousand_Quintals,$
 $Consumption_Shipment_of_cereal[Sorghum]*Hundred_grams_per_Kg*KG_in_thousand_Quintals)$

UNITS: gram/year

$Consumed_Effective_Cereal_in_Hundred_grams[Millet] =$
 $MIN(Desired_Effective_Cereal_Consumption[Millet]*Hundred_grams_per_Kg*KG_in_thousand_Quintals,$
 $Consumption_Shipment_of_cereal[Millet]*Hundred_grams_per_Kg*KG_in_thousand_Quintals)$

UNITS: gram/year

$Consumed_Effective_Cereal_in_Hundred_grams[Oats] =$
 $MIN(Desired_Effective_Cereal_Consumption[Oats]*Hundred_grams_per_Kg*KG_in_thousand_Quintals,$
 $Consumption_Shipment_of_cereal[Oats]*Hundred_grams_per_Kg*KG_in_thousand_Quintals)$

UNITS: gram/year

$Cultivation_Area_adjustment_Time = 3$

UNITS: year

$Cultivation_Area_share_of_cereals[Tef] = Cultivation_Area_share_of_Tef$

UNITS: Unitless

$Cultivation_Area_share_of_cereals[Wheat] = Cultivation_Area_share_of_Wheat$

UNITS: Unitless

$Cultivation_Area_share_of_cereals[Maize] = Cultivation_Area_share_of_Maize$

UNITS: Unitless

$Cultivation_Area_share_of_cereals[Barely] = Cultivation_Area_share_of_Barely$

UNITS: Unitless

$Cultivation_Area_share_of_cereals[Rice] = Cultivation_Area_share_of_Rice$

UNITS: Unitless

$Cultivation_Area_share_of_cereals[Sorghum] = Cultivation_Area_share_of_Sorghum$

UNITS: Unitless

$Cultivation_Area_share_of_cereals[Millet] = Cultivation_Area_share_of_Millet$

UNITS: Unitless

$Cultivation_Area_share_of_cereals[Oats] = Cultivation_Area_share_of_Oats$

UNITS: Unitless

$Cultivation_Area_share_of_Maize = GRAPH(TIME)$

(1995, 0.193), (3216, 0.197), (4437, 0.196), (5658, 0.193), (6879, 0.208), (8100, 0.225), (9321, 0.208), (10542, 0.188), (11763, 0.195), (12984, 0.182), (14205, 0.189), (15426, 0.2), (16647, 0.202), (17868, 0.202), (19089, 0.192), (20310, 0.212)

Cultivation_Area__share_of_Barely = GRAPH(TIME)

(1995, 0.124), (1996, 0.104), (1997, 0.122), (1998, 0.123), (1999, 0.118), (2000, 0.114), (2001, 0.121), (2002, 0.125), (2003, 0.131), (2004, 0.143), (2005, 0.123), (2006, 0.12), (2007, 0.113), (2008, 0.111), (2009, 0.122), (2010, 0.108)

Cultivation_Area__share_of_Millet = GRAPH(TIME)

(1995, 0.0404), (1996, 0.0434), (1997, 0.0517), (1998, 0.0662), (1999, 0.0533), (2000, 0.0454), (2001, 0.0441), (2002, 0.0487), (2003, 0.0435), (2004, 0.0421), (2005, 0.0412), (2006, 0.0441), (2007, 0.0457), (2008, 0.0465), (2009, 0.0399), (2010, 0.0421)

Cultivation_Area__share_of_Oats = GRAPH(TIME)

(1995, 0.0067), (1996, 0.0064), (1997, 0.007), (1998, 0.006), (1999, 0.006), (2000, 0.005), (2001, 0.004), (2002, 0.004), (2003, 0.004), (2004, 0.0059), (2005, 0.005), (2006, 0.0038), (2007, 0.0035), (2008, 0.0034), (2009, 0.0026), (2010, 0.0031)

Cultivation_Area__share_of_Rice = GRAPH(TIME)

(1995, 1e-005), (1996, 1e-005), (1997, 1e-005), (1998, 1e-005), (1999, 1e-005), (2000, 1e-006), (2001, 0.001), (2002, 0.001), (2003, 1e-005), (2004, 1e-005), (2005, 0.001), (2006, 1e-005), (2007, 0.003), (2008, 1e-005), (2009, 0.004), (2010, 0.005)

Cultivation_Area__share_of_Sorghum = GRAPH(TIME)

(1995, 0.188), (1996, 0.209), (1997, 0.17), (1998, 0.155), (1999, 0.147), (2000, 0.174), (2001, 0.178), (2002, 0.17), (2003, 0.183), (2004, 0.164), (2005, 0.182), (2006, 0.173), (2007, 0.176), (2008, 0.184), (2009, 0.175), (2010, 0.16)

Cultivation_Area__share_of_Tef = GRAPH(TIME)

(1995, 0.315), (1996, 0.324), (1997, 0.312), (1998, 0.31), (1999, 0.315), (2000, 0.285), (2001, 0.285), (2002, 0.305), (2003, 0.284), (2004, 0.28), (2005, 0.278), (2006, 0.284), (2007, 0.294), (2008, 0.283), (2009, 0.28), (2010, 0.295)

Cultivation_Area__share_of_Wheat = GRAPH(TIME)

(1995, 0.133), (1996, 0.115), (1997, 0.141), (1998, 0.146), (1999, 0.152), (2000, 0.149), (2001, 0.158), (2002, 0.178), (2003, 0.157), (2004, 0.183), (2005, 0.181), (2006, 0.174), (2007, 0.163), (2008, 0.166), (2009, 0.182), (2010, 0.17)

Desired_Area__for_cultivation_in_thousands = *Desired__Cultivation_Land/Unit_Adjustment_thousand*

UNITS: hectare

Desired_Cereal__Cultivated_area = *Arable_cereal__fraction*Desired_Area__for_cultivation_in_thousands*

UNITS: hectare

Desired_Cultivation_area_for_input_covered = *Cereal_Cultivated__Area_in_thousand_Ha*

Desired_Edible_100_gram__of__Cerealsper_Year_PC[Tef] =
Desired_Net_Kcal__of_Cereal_per_Year_PC[Tef]/Kcal_per_100Gm__Edible_portion_of_Cereal[Tef]

UNITS: gram/year-person

Desired_Edible_100_gram__of__Cerealsper_Year_PC[Wheat] =
Desired_Net_Kcal__of_Cereal_per_Year_PC[Wheat]/Kcal_per_100Gm__Edible_portion_of_Cereal[Wheat]

UNITS: gram/year-person

Desired_Edible_100_gram__of__Cerealsper_Year_PC[Maize] =
Desired_Net_Kcal__of_Cereal_per_Year_PC[Maize]/Kcal_per_100Gm__Edible_portion_of_Cereal[Maize]

UNITS: gram/year-person

Desired_Edible_100_gram__of__Cerealsper_Year_PC[Barely] =
Desired_Net_Kcal__of_Cereal_per_Year_PC[Barely]/Kcal_per_100Gm__Edible_portion_of_Cereal[Barely]

UNITS: gram/year-person

Desired_Edible_100_gram__of__Cerealsper_Year_PC[Rice] =
Desired_Net_Kcal__of_Cereal_per_Year_PC[Rice]/Kcal_per_100Gm__Edible_portion_of_Cereal[Rice]

UNITS: gram/year-person

Desired_Edible_100_gram__of__Cerealsper_Year_PC[Sorghum] =
Desired_Net_Kcal__of_Cereal_per_Year_PC[Sorghum]/Kcal_per_100Gm__Edible_portion_of_Cereal[Sorghum]

UNITS: gram/year-person

Desired_Edible_100_gram__of__Cerealsper_Year_PC[Millet] =
Desired_Net_Kcal__of_Cereal_per_Year_PC[Millet]/Kcal_per_100Gm__Edible_portion_of_Cereal[Millet]

UNITS: gram/year-person

Desired_Edible_100_gram__of__Cerealsper_Year_PC[Oats] =
Desired_Net_Kcal__of_Cereal_per_Year_PC[Oats]/Kcal_per_100Gm__Edible_portion_of_Cereal[Oats]

UNITS: gram/year-person

Desired_Kcal_share_of_Cereals[Tef] =
IF(TIME<2014)THEN(PC_Share_of__Tef_from_total_monthly__calorie_consumption)ELSE(Tefe_KCAL_share)

UNITS: Unitless

Desired_Kcal_share_of_Cereals[Wheat] =
IF(TIME<2014)THEN(PC_Share_of__Wheat_from_total_monthly__calorie_consumption)ELSE(wheat_Kcal_share)

UNITS: Unitless

Desired_Kcal_share_of_Cereals[Maize] =
IF(TIME<2014)THEN(PC_Share_of__Maize_from_total_monthly__calorie_consumption)ELSE(Maize_Kcal_share)

UNITS: Unitless

Desired_Kcal_share_of_Cereals[Barely] =
IF(TIME<2014)THEN(PC_Share_of__Barely_from_total_monthly__calorie_consumption)ELSE(Barely_Kcal_s
hare)

UNITS: Unitless

Desired_Kcal_share_of_Cereals[Rice] =
IF(TIME<2014)THEN(PC_Share_of__Rice_from_total_monthly__calorie_consumption)ELSE(Rice_Kcal_Shar
e)

UNITS: Unitless

Desired_Kcal_share_of_Cereals[Sorghum] =
IF(TIME<2014)THEN(PC_Share_of__Sorghum_from_total_monthly__calorie_consumption)ELSE(Sorghum_K
cal_share)

UNITS: Unitless

Desired_Kcal_share_of_Cereals[Millet] =
IF(TIME<2014)THEN(PC_Share_of__Millet_from_total_monthly__calorie_consumption)ELSE(Millet_Kcal_S
hare)

UNITS: Unitless

Desired_Kcal_share_of_Cereals[Oats] =
IF(TIME<2014)THEN(PC_Share_of__Oats_from_total_monthly__calorie_consumption)ELSE(Oats_Kcal_shar
e)

UNITS: Unitless

Desired_Net_Kcal_of_cereal_per_day_PC =
*IF(TIME<2010)THEN(National_Cumulative_Net__Adult_Equivalent_calorie_PC_per_day*Share_of_cereal__i*
*n_daily_Kcal_consumption)ELSE(National_Cumulative_Net__Adult_Equivalent_calorie_PC_per_day*FOrcast*
ed_share_of_cereal_in_kcal_consumption)

UNITS: kilocalorie/day-person

Desired_Net_Kcal__of_Cereal_per_Year_PC[Tef] =
*Annual_Desired_net_Kcal_Consumption_PC*Desired_Kcal_share_of_Cereals[Tef]*

UNITS: kilocalorie/year-person

Desired_Net_Kcal__of_Cereal_per_Year_PC[Wheat] =
*Annual_Desired_net_Kcal_Consumption_PC*Desired_Kcal_share_of_Cereals[Wheat]*

UNITS: kilocalorie/year-person

Desired_Net_Kcal__of_Cereal_per_Year_PC[Maize] =
*Annual_Desired_net_Kcal_Consumption_PC*Desired_Kcal_share_of_Cereals[Maize]*

UNITS: kilocalorie/year-person

Desired_Net_Kcal__of_Cereal_per_Year_PC[Barely] =
*Annual_Desired_net_Kcal_Consumption_PC*Desired_Kcal_share_of_Cereals[Barely]*

UNITS: kilocalorie/year-person

Desired_Net_Kcal__of_Cereal_per_Year_PC[Rice] =
*Annual_Desired_net_Kcal_Consumption_PC*Desired_Kcal_share_of_Cereals[Rice]*

UNITS: kilocalorie/year-person

Desired_Net_Kcal__of_Cereal_per_Year_PC[Sorghum] =
*Annual_Desired_net_Kcal_Consumption_PC*Desired_Kcal_share_of_Cereals[Sorghum]*

UNITS: kilocalorie/year-person

Desired_Net_Kcal__of_Cereal_per_Year_PC[Millet] =
*Annual_Desired_net_Kcal_Consumption_PC*Desired_Kcal_share_of_Cereals[Millet]*

UNITS: kilocalorie/year-person

Desired_Net_Kcal__of_Cereal_per_Year_PC[Oats] =
*Annual_Desired_net_Kcal_Consumption_PC*Desired_Kcal_share_of_Cereals[Oats]*

UNITS: kilocalorie/year-person

Desired_Population__Nourished =
Comulative_Desired_Cereal_Calories_per_year/Annual_Desired_net_Kcal_Consumption_PC

UNITS: people (person)

Desired__Effective_Cereal__Consumption[Tef] =
MIN(Desired__Cereal_Consumption[Tef],Desired__purchased_cereal[Tef])

UNITS: quintal/year

Desired__Effective_Cereal__Consumption[Wheat] =
MIN(Desired__Cereal_Consumption[Tef],Desired__purchased_cereal[Wheat])

UNITS: quintal/year

Desired__Effective_Cereal__Consumption[Maize] =
MIN(Desired__Cereal_Consumption[Maize],Desired__purchased_cereal[Maize])

UNITS: quintal/year

Desired__Effective_Cereal__Consumption[Barely] =
MIN(Desired__Cereal_Consumption[Barely],Desired__purchased_cereal[Barely])

UNITS: quintal/year

Desired__Effective_Cereal__Consumption[Rice] =
MIN(Desired__Cereal_Consumption[Rice],Desired__purchased_cereal[Rice])

UNITS: quintal/year

Desired__Effective_Cereal__Consumption[Sorghum] =
MIN(Desired__Cereal_Consumption[Sorghum],Desired__purchased_cereal[Sorghum])

UNITS: quintal/year

Desired__Effective_Cereal__Consumption[Millet] =
MIN(Desired__Cereal_Consumption[Millet],Desired__purchased_cereal[Millet])

UNITS: quintal/year

$Desired_Effective_Cereal_Consumption[Oats] =$
 $MIN(Desired_Cereal_Consumption[Oats],Desired_purchased_cereal[Oats])$

UNITS: quintal/year

$Desired_purchased_cereal[cereal] =$
 $Budget_Alloted_for_cereal_Consumption_per_year/Retailer_Price_per_thousand_Quintal$

UNITS: quintal/year

$Desired_Cereal_Consumption[Tef] =$
 $Comulative_Desired_Kg_of_Cereals_per_Year[Tef]/KG_in_thousand_Quintals$

UNITS: quintal/year

$Desired_Cereal_Consumption[Wheat] =$
 $Comulative_Desired_Kg_of_Cereals_per_Year[Wheat]/KG_in_thousand_Quintals$

UNITS: quintal/year

$Desired_Cereal_Consumption[Maize] =$
 $Comulative_Desired_Kg_of_Cereals_per_Year[Maize]/KG_in_thousand_Quintals$

UNITS: quintal/year

$Desired_Cereal_Consumption[Barely] =$
 $Comulative_Desired_Kg_of_Cereals_per_Year[Barely]/KG_in_thousand_Quintals$

UNITS: quintal/year

$Desired_Cereal_Consumption[Rice] =$
 $Comulative_Desired_Kg_of_Cereals_per_Year[Rice]/KG_in_thousand_Quintals$

UNITS: quintal/year

$Desired_Cereal_Consumption[Sorghum] =$
 $Comulative_Desired_Kg_of_Cereals_per_Year[Sorghum]/KG_in_thousand_Quintals$

UNITS: quintal/year

$Desired_Cereal_Consumption[Millet] =$
 $Comulative_Desired_Kg_of_Cereals_per_Year[Millet]/KG_in_thousand_Quintals$

UNITS: quintal/year

$Desired_Cereal_Consumption[Oats] =$
 $Comulative_Desired_Kg_of_Cereals_per_Year[Oats]/KG_in_thousand_Quintals$

UNITS: quintal/year

$Desired_Cultivation_Land = Population.Total_Population*Average_Cultivation_Area_PC$

UNITS: hectare/people

$Diesel_Price_USD = GRAPH(TIME)$

(1995, 0.19), (1997, 0.24), (1999, 0.25), (2001, 0.27), (2003, 0.32), (2004, 0.42), (2006, 0.62), (2008, 0.89), (2010, 0.78)

UNITS: usd per litter

Distribution_of_Belg_and_imported_cereal = GRAPH(Months_in_a_year_Adjustment)

(0.00, 0.00), (0.0909, 0.00), (0.182, 0.549), (0.273, 2.40), (0.364, 3.13), (0.455, 2.88), (0.545, 1.98), (0.636, 0.04), (0.727, 0.00), (0.818, 0.00), (0.909, 0.00), (1.00, 0.00)

UNITS: Unitless

Effective__Calories_per_year =

$Kcal_per_100Gm_Edible_portion_of_Cereal[Tef]*Consumed_Effective_edible_cereals_in_hundred_grams[Tef]+Kcal_per_100Gm_Edible_portion_of_Cereal[Wheat]*Consumed_Effective_edible_cereals_in_hundred_grams[Wheat]+Kcal_per_100Gm_Edible_portion_of_Cereal[Maize]*Consumed_Effective_edible_cereals_in_hundred_grams[Maize]+Kcal_per_100Gm_Edible_portion_of_Cereal[Barely]*Consumed_Effective_edible_cereals_in_hundred_grams[Barely]+Kcal_per_100Gm_Edible_portion_of_Cereal[Rice]*Consumed_Effective_edible_cereals_in_hundred_grams[Rice]+Kcal_per_100Gm_Edible_portion_of_Cereal[Sorghum]*Consumed_Effective_edible_cereals_in_hundred_grams[Sorghum]+Kcal_per_100Gm_Edible_portion_of_Cereal[Millet]*Consumed_Effective_edible_cereals_in_hundred_grams[Millet]+Kcal_per_100Gm_Edible_portion_of_Cereal[Oats]*Consumed_Effective_edible_cereals_in_hundred_grams[Oats]$

UNITS: kilocalorie/year

Effect_of_Fuel_Price_and_Road_network_on_Retailer_Price =

$Relative_Fuel_Price^{0.4}*(1/Relative_Road_Network)^{0.60}$

UNITS: Unitless

Effect_of_Inventory_Ratio_on_Price = GRAPH(Inventory_Ratio)

(0.00, 1.01), (0.105, 1.01), (0.211, 1.01), (0.316, 1.01), (0.421, 1.00), (0.526, 1.00), (0.632, 0.993), (0.737, 0.986), (0.842, 0.98), (0.947, 0.978), (1.05, 0.978), (1.16, 0.978), (1.26, 0.978), (1.37, 0.984), (1.47, 0.978), (1.58, 0.976), (1.68, 0.973), (1.79, 0.973), (1.89, 0.973), (2.00, 0.973)

UNITS: Unitless

Effect_of_yeild_and_producer__price_on_consumption_Expenditure = Yield_Sector.Relative_yield^{0.8}

UNITS: Unitless

EstimatedConsumption__Expenditure__Share_of_Barely = GRAPH(TIME)

(1995, 0.065), (2000, 0.03), (2005, 0.07), (2010, 0.1)

EstimatedConsumption__Expenditure__Share_of_Maize = GRAPH(TIME)

(1995, 0.18), (2000, 0.175), (2005, 0.2), (2010, 0.25)

EstimatedConsumption__Expenditure__Share_of_Millet = GRAPH(TIME)

(1995, 0.015), (2000, 0.015), (2005, 0.012), (2010, 0.005)

EstimatedConsumption__Expenditure__Share_of_Oats = GRAPH(TIME)

(1995, 0.001), (2000, 0.001), (2005, 0.001), (2010, 0.0008)

EstimatedConsumption__Expenditure__Share_of_Rice = GRAPH(TIME)

(1995, 0.0015), (2000, 0.0016), (2005, 0.005), (2010, 0.09)

EstimatedConsumption__Expenditure__Share_of_Tef = GRAPH(TIME)

(1995, 0.335), (2000, 0.32), (2005, 0.26), (2010, 0.18)

EstimatedConsumption__Expenditure__Share_of_Wheat = GRAPH(TIME)

(1995, 0.24), (2000, 0.275), (2005, 0.31), (2010, 0.35)

Estimated_Belg__Barley_Production = GRAPH(TIME)

(1995, 934), (1996, 1027), (1997, 1005), (1998, 1087), (1999, 704), (2000, 906), (2001, 904), (2002, 835), (2003, 760), (2004, 934), (2005, 1277), (2006, 1200), (2007, 1122), (2008, 1371), (2009, 1308), (2010, 1513)

Estimated_Belg__Maize_Production = GRAPH(TIME)

(1995, 3600), (1996, 3760), (1997, 4120), (1998, 4280), (1999, 4720), (2000, 3560), (2001, 3800), (2002, 3280), (2003, 3280), (2004, 5122), (2005, 5751), (2006, 4935), (2007, 4120), (2008, 4003), (2009, 4003), (2010, 7598)

Estimated_Belg__Millet_Production = GRAPH(TIME)

(1995, 9.00), (1996, 0.00), (1997, 14.0), (1998, 3.00), (1999, 0.00), (2000, 33.0), (2001, 3.00), (2002, 0.00), (2003, 42.0), (2004, 0.87), (2005, 3.88), (2006, 0.00), (2007, 0.00), (2008, 139), (2009, 184), (2010, 184)

Estimated_Belg__Oats_Production = GRAPH(TIME)

(1995, 49.8), (1996, 59.4), (1997, 54.6), (1998, 53.2), (1999, 47.8), (2000, 43.0), (2001, 40.3), (2002, 41.0), (2003, 41.0), (2004, 11.3), (2005, 168), (2006, 144), (2007, 120), (2008, 101), (2009, 0.00), (2010, 0.00)

Estimated_Belg__Rice_Production = GRAPH(TIME)

(1995, 0.00), (1996, 0.00), (1997, 0.00), (1998, 0.00), (1999, 0.00), (2000, 0.00), (2001, 0.00), (2002, 0.00), (2003, 0.00), (2004, 0.00), (2005, 0.00), (2006, 0.00), (2007, 0.00), (2008, 0.00), (2009, 0.00), (2010, 0.00)

Estimated_Belg__Sorghum_Production = GRAPH(TIME)

(1995, 669), (1996, 614), (1997, 669), (1998, 380), (1999, 628), (2000, 587), (2001, 580), (2002, 532), (2003, 418), (2004, 1957), (2005, 266), (2006, 263), (2007, 260), (2008, 375), (2009, 375), (2010, 810)

Estimated_Belg__Tef_Production = GRAPH(TIME)

(1995, 404), (1996, 416), (1997, 376), (1998, 376), (1999, 373), (2000, 373), (2001, 373), (2002, 376), (2003, 432), (2004, 373), (2005, 719), (2006, 522), (2007, 326), (2008, 404), (2009, 404), (2010, 908)

Estimated_Belg__Wheat_Production = GRAPH(TIME)

(1995, 567), (1996, 446), (1997, 563), (1998, 536), (1999, 455), (2000, 558), (2001, 567), (2002, 513), (2003, 477), (2004, 544), (2005, 878), (2006, 774), (2007, 671), (2008, 713), (2009, 713), (2010, 724)

Estimated_Cereal_Expenditure__share[Tef] = Tef__Expenditure_Share

UNITS: Unitless

Estimated_Cereal_Expenditure__share[Wheat] = Wheat__Expenditure_Share

UNITS: Unitless

Estimated_Cereal_Expenditure__share[Maize] = Maize__Expenditure_Share

UNITS: Unitless

Estimated_Cereal_Expenditure__share[Barely] = Barley__Ecpenditure_Share

UNITS: Unitless

Estimated_Cereal_Expenditure__share[Rice] = Rice__Expenditure_Share

UNITS: Unitless

Estimated_Cereal_Expenditure__share[Sorghum] = Sorghum__Expenditure_Share

UNITS: Unitless

Estimated_Cereal_Expenditure__share[Millet] = Millet__Expenditure_Share

UNITS: Unitless

Estimated_Cereal_Expenditure__share[Oats] = Oats__Expenditure_Share

UNITS: Unitless

Estimated_Consumption_Share_of_Cereals[Tef] = EstimatedConsumption__Expenditure__Share_of_Tef

Estimated_Consumption_Share_of_Cereals[Wheat] = EstimatedConsumption__Expenditure__Share_of_Wheat

Estimated_Consumption_Share_of_Cereals[Maize] = EstimatedConsumption__Expenditure__Share_of_Maize

Estimated_Consumption_Share_of_Cereals[Barely] = EstimatedConsumption__Expenditure__Share_of_Barely

Estimated_Consumption_Share_of_Cereals[Rice] = EstimatedConsumption__Expenditure__Share_of_Rice

*Estimated_Consumption_Share_of_Cereals[Sorghum] =
Estimated_Consumption__Expenditure__Share_of_Sorghum*

Estimated_Consumption_Share_of_Cereals[Millet] = EstimatedConsumption__Expenditure__Share_of_Millet

Estimated_Consumption_Share_of_Cereals[Oats] = EstimatedConsumption__Expenditure__Share_of_Oats

Estimated_Consumption__Expenditure__Share_of_Sorghum = GRAPH(TIME)

(1995, 0.16), (2000, 0.17), (2005, 0.17), (2010, 0.123)

Estimated_Markup_Fraction = 0.18

UNITS: Unitless

Forecasted_cereareal_share_of_expenditure = GRAPH(TIME)

(2010, 0.19), (2015, 0.186), (2020, 0.182), (2025, 0.177)

UNITS: Unitless

Forecasted_PC_Expenditure_for_cereal_consumption = GRAPH(TIME)

(2010, 4304), (2015, 4952), (2020, 6123), (2025, 7676)

UNITS: birr/person-year

FOrcasted_share_of_cerealin_kcal_consumption = GRAPH(TIME)

(2010, 0.579), (2015, 0.56), (2020, 0.542), (2025, 0.524)

Fraction_lost_as_of_food_preparation[Tef] = 0.1764

UNITS: Unitless

Fraction_lost_as_of_food_preparation[Wheat] = 0.25

UNITS: Unitless

Fraction_lost_as_of_food_preparation[Maize] = 0.33

UNITS: Unitless

Fraction_lost_as_of_food_preparation[Barely] = 0.4

UNITS: Unitless

Fraction_lost_as_of_food_preparation[Rice] = 0.123

UNITS: Unitless

Fraction_lost_as_of_food_preparation[Sorghum] = 0.25

UNITS: Unitless

Fraction_lost_as_of_food_preparation[Millet] = 0.25

UNITS: Unitless

Fraction_lost_as_of_food_preparation[Oats] = 0.25

UNITS: Unitless

Fraction__For_Sale = GRAPH(TIME)

(1995, 0.125), (1998, 0.125), (2001, 0.15), (2004, 0.22), (2007, 0.36), (2010, 0.47)

UNITS: Unitless

*Fuel_Price__in_Birr = Average__Exchange_rate*Average_Fuel__price_USD*

UNITS: birr/litter

Gasoline_Price_USD = GRAPH(TIME)

(1995, 0.26), (1997, 0.32), (1999, 0.36), (2001, 0.46), (2003, 0.52), (2004, 0.6), (2006, 0.93), (2008, 0.92), (2010, 0.91)

UNITS: usd per litter

Historical_Barely_Production = GRAPH(TIME)

(1995, 8725), (1996, 7424), (1997, 7864), (1998, 7686), (1999, 7419), (2000, 9454), (2001, 9319), (2002, 6900), (2003, 10797), (2004, 13281), (2005, 12707), (2006, 13521), (2007, 13548), (2008, 15194), (2009, 17504), (2010, 17504)

Historical_Belg__Barley_Production = GRAPH(TIME)

(1995, 0.00), (1996, 0.00), (1997, 0.00), (1998, 0.00), (1999, 0.00), (2000, 0.00), (2001, 0.00), (2002, 0.00), (2003, 76.8), (2004, 475), (2005, 1277), (2006, 1200), (2007, 1122), (2008, 1371), (2009, 1308), (2010, 1513)

Historical_Belg__Maize_Production = GRAPH(TIME)

(1995, 0.00), (1996, 0.00), (1997, 0.00), (1998, 0.00), (1999, 0.00), (2000, 0.00), (2001, 0.00), (2002, 0.00), (2003, 2009), (2004, 5122), (2005, 5751), (2006, 4935), (2007, 4120), (2008, 4003), (2009, 4003), (2010, 7598)

Historical_Belg__Millet_Production = GRAPH(TIME)

(1995, 0.00), (1996, 0.00), (1997, 0.00), (1998, 0.00), (1999, 0.00), (2000, 0.00), (2001, 0.00), (2002, 0.00), (2003, 0.00), (2004, 0.87), (2005, 3.88), (2006, 0.00), (2007, 0.00), (2008, 139), (2009, 184), (2010, 184)

Historical_Belg__Oats_Production = GRAPH(TIME)

(1995, 0.00), (1996, 0.00), (1997, 0.00), (1998, 0.00), (1999, 0.00), (2000, 0.00), (2001, 0.00), (2002, 0.00), (2003, 0.00), (2004, 11.3), (2005, 168), (2006, 144), (2007, 120), (2008, 101), (2009, 0.00), (2010, 0.00)

Historical_Belg__Rice_Production = GRAPH(TIME)

(1995, 0.00), (1996, 0.00), (1997, 0.00), (1998, 0.00), (1999, 0.00), (2000, 0.00), (2001, 0.00), (2002, 0.00), (2003, 0.00), (2004, 0.00), (2005, 0.00), (2006, 0.00), (2007, 0.00), (2008, 0.00), (2009, 0.00), (2010, 0.00)

Historical_Belg__Sorghum_Production = GRAPH(TIME)

(1995, 0.00), (1996, 0.00), (1997, 0.00), (1998, 0.00), (1999, 0.00), (2000, 0.00), (2001, 0.00), (2002, 0.00), (2003, 418), (2004, 1957), (2005, 266), (2006, 263), (2007, 260), (2008, 375), (2009, 375), (2010, 810)

Historical_Belg__Tef_Production = GRAPH(TIME)

(1995, 0.00), (1996, 0.00), (1997, 0.00), (1998, 0.00), (1999, 0.00), (2000, 0.00), (2001, 0.00), (2002, 0.00), (2003, 9.73), (2004, 222), (2005, 719), (2006, 522), (2007, 326), (2008, 404), (2009, 404), (2010, 908)

Historical_Belg__Wheat_Production = GRAPH(TIME)

(1995, 0.00), (1996, 0.00), (1997, 0.00), (1998, 0.00), (1999, 0.00), (2000, 0.00), (2001, 0.00), (2002, 0.00), (2003, 36.5), (2004, 100), (2005, 878), (2006, 774), (2007, 671), (2008, 713), (2009, 713), (2010, 724)

Historical_Cereal__Production[Tef] = Historical__Tef_Production

Historical_Cereal__Production[Wheat] = Historical__Wheat_Production

Historical_Cereal__Production[Maize] = Historical__Maize_Production

Historical_Cereal__Production[Barely] = Historical__Barely_Production

Historical_Cereal__Production[Rice] = Historical__Rice_Production

Historical_Cereal__Production[Sorghum] = Historical__Sorghum_Production

Historical_Cereal__Production[Millet] = Historical__Millet_Production

Historical_Cereal__Production[Oats] = Historical__Oats_Production

Historical_Meher_Area = GRAPH(TIME)

(1995, 6653), (1996, 6689), (1997, 5602), (1998, 6745), (1999, 6747), (2000, 7637), (2001, 6370), (2002, 6324), (2003, 6999), (2004, 7638), (2005, 8081), (2006, 8472), (2007, 8730), (2008, 8770), (2009, 9233), (2010, 9691)

Historical_population = GRAPH(TIME)

(1995, 5.7e+007), (1996, 5.9e+007), (1997, 6e+007), (1998, 6.2e+007), (1999, 6.4e+007), (2000, 6.6e+007), (2001, 6.7e+007), (2002, 6.9e+007), (2003, 7.1e+007), (2004, 7.3e+007), (2005, 7.4e+007), (2006, 7.6e+007), (2007, 7.8e+007), (2008, 7.9e+007), (2009, 8.1e+007), (2010, 8.3e+007)

Historical_Privalence_of_Undernourishment = GRAPH(TIME)

(1995, 0.64), (2000, 0.535), (2005, 0.463), (2010, 0.402)

Historical_Rice_Production = GRAPH(TIME)

(1995, 0.00), (1996, 0.00), (1997, 0.00), (1998, 0.00), (1999, 0.00), (2000, 0.00), (2001, 154), (2002, 0.00), (2003, 0.00), (2004, 0.00), (2005, 112), (2006, 0.00), (2007, 713), (2008, 714), (2009, 1031), (2010, 1031)

Historical_Total_Fertilizer_Consumption_in_Quntals = GRAPH(TIME)

(1995, 2.5e+006), (1996, 2.5e+006), (1997, 2.2e+006), (1998, 2.8e+006), (1999, 2.9e+006), (2000, 3e+006), (2001, 2.8e+006), (2002, 2.3e+006), (2003, 2.6e+006), (2004, 3.2e+006), (2005, 3.5e+006), (2006, 3.8e+006), (2007, 3.9e+006), (2008, 4e+006), (2009, 4.3e+006), (2010, 5e+006)

Historical_Annual_Avarage_PC_Expenditure = GRAPH(TIME)

(1995, 1319), (2000, 1412), (2005, 1697), (2010, 4508)

UNITS: birr/person-year

Historical_Cereal_Production1[Tef] = Historical_Cereal_Production[Tef](1-Share_of_Cereal_for_seed_and_non_consumption)*

Historical_Cereal_Production1[Wheat] = Historical_Cereal_Production[Wheat](1-Share_of_Cereal_for_seed_and_non_consumption)*

Historical_Cereal_Production1[Maize] = Historical_Cereal_Production[Maize](1-Share_of_Cereal_for_seed_and_non_consumption)*

Historical_Cereal_Production1[Barely] = Historical_Cereal_Production[Barely](1-Share_of_Cereal_for_seed_and_non_consumption)*

Historical_Cereal_Production1[Rice] = Historical_Cereal_Production[Rice](1-Share_of_Cereal_for_seed_and_non_consumption)*

Historical_Cereal_Production1[Sorghum] = Historical_Cereal_Production[Sorghum](1-Share_of_Cereal_for_seed_and_non_consumption)*

Historical_Cereal_Production1[Millet] = Historical_Cereal_Production[Millet](1-Share_of_Cereal_for_seed_and_non_consumption)*

Historical_Cereal_Production1[Oats] = Historical_Cereal_Production[Oats](1-Share_of_Cereal_for_seed_and_non_consumption)*

Historical_Maize_Production = GRAPH(TIME)

(1995, 25393), (1996, 25320), (1997, 19289), (1998, 24166), (1999, 25255), (2000, 31385), (2001, 28002), (2002, 17880), (2003, 25430), (2004, 23942), (2005, 33368), (2006, 37764), (2007, 37497), (2008, 39325), (2009, 38972), (2010, 38972)

Historical__Millet_Production = GRAPH(TIME)

(1995, 2413), (1996, 2962), (1997, 2587), (1998, 3815), (1999, 3195), (2000, 3162), (2001, 3062), (2002, 3092), (2003, 3051), (2004, 3328), (2005, 3970), (2006, 4844), (2007, 5380), (2008, 5603), (2009, 5242), (2010, 5242)

Historical__Oats_Production = GRAPH(TIME)

(1995, 652), (1996, 479), (1997, 410), (1998, 394), (1999, 430), (2000, 496), (2001, 352), (2002, 252), (2003, 387), (2004, 567), (2005, 402), (2006, 362), (2007, 366), (2008, 428), (2009, 330), (2010, 330)

Historical__Sorghum_Production = GRAPH(TIME)

(1995, 17227), (1996, 20073), (1997, 10697), (1998, 13208), (1999, 11811), (2000, 15383), (2001, 15462), (2002, 19398), (2003, 17425), (2004, 17160), (2005, 21736), (2006, 23160), (2007, 26591), (2008, 28044), (2009, 29713), (2010, 29713)

Historical__Tef_Production = GRAPH(TIME)

(1995, 17524), (1996, 20019), (1997, 13073), (1998, 16423), (1999, 17176), (2000, 17369), (2001, 16273), (2002, 14196), (2003, 16773), (2004, 20255), (2005, 21756), (2006, 24377), (2007, 29929), (2008, 30280), (2009, 31794), (2010, 31794)

Historical__Wheat_Production = GRAPH(TIME)

(1995, 10763), (1996, 10016), (1997, 11068), (1998, 11138), (1999, 12126), (2000, 15712), (2001, 14444), (2002, 10721), (2003, 16144), (2004, 21766), (2005, 22191), (2006, 24631), (2007, 23145), (2008, 27376), (2009, 30756), (2010, 30756)

Hundred__grams_per_Kg = 10

UNITS: gram/kilogram

*Imported_Cereals[Tef] = Impote_reductin_fraction*Tef__net_import*

UNITS: quintal/year

*Imported_Cereals[Wheat] = Impote_reductin_fraction*Wheat__net_import*

UNITS: quintal/year

*Imported_Cereals[Maize] = Impote_reductin_fraction*Maize__net_import*

UNITS: quintal/year

*Imported_Cereals[Barely] = Impote_reductin_fraction*Barely__net_import*

UNITS: quintal/year

*Imported_Cereals[Rice] = Impote_reductin_fraction*Rice__net_import*

UNITS: quintal/year

*Imported_Cereals[Sorghum] = Impote_reductin_fraction*Sorghum__net_import*

UNITS: quintal/year

$Imported_Cereals[Millet] = Impote_reductin_fraction * Millet_net_import$

UNITS: quintal/year

$Imported_Cereals[Oats] = Impote_reductin_fraction * Oats_net_import$

UNITS: quintal/year

$Impote_reductin_fraction = GRAPH(TIME)$

(2014, 0.994), (2014, 0.99), (2015, 0.959), (2015, 0.902), (2015, 0.851), (2016, 0.79), (2016, 0.705), (2017, 0.597), (2017, 0.521), (2017, 0.454), (2018, 0.39), (2018, 0.33), (2018, 0.279), (2019, 0.229), (2019, 0.175), (2020, 0.124), (2020, 0.0857), (2020, 0.054), (2021, 0.0413), (2021, 0.0286), (2021, 0.0286), (2022, 0.0222), (2022, 0.0127), (2022, 0.0127), (2023, 0.00952), (2023, 0.00), (2024, 0.00), (2024, 0.00), (2024, 0.00), (2025, 0.00), (2025, 0.00)

$Indicated_Producer_Price[cereal] =$

$Producer_Price_per_000_Quin * (1 + Annual_Inflation_Rate_Producer_Price) * Effect_of_Inventory_Ratio_on_Price$

UNITS: birr/quintal

$Indicated_Inventory =$

$Inventory_Coverage * (Desired_Cereal_Consumption[Tef] + Desired_Cereal_Consumption[Wheat] + Desired_Cereal_Consumption[Maize] + Desired_Cereal_Consumption[Barely] + Desired_Cereal_Consumption[Rice] + Desired_Cereal_Consumption[Sorghum] + Desired_Cereal_Consumption[Millet] + Desired_Cereal_Consumption[Oats])$

UNITS: quintal

$Inventory_Ratio = Total_Inventory / (Indicated_Inventory)$

UNITS: Unitless

$Inventory_Coverage = 1.2$

UNITS: year

$Investment_share_for_Revenue = 0.9$

UNITS: Unitless

$Kcal_Net_Consumption_per_day_for_Adult = 3000$

UNITS: kilocalorie/day-person

DOCUMENT: 3000 kcal

$Kcal_per_100Gm_Edible_portion_of_Cereal[Tef] = Calorie_per_100gm_Tef_flour$

UNITS: kilocalorie/gram

$Kcal_per_100Gm_Edible_portion_of_Cereal[Wheat] = Calorie_per_100_gm_wheat_grain$

UNITS: kilocalorie/gram

Kcal_per_100Gm__Edible_portion_of_Cereal[Maize] = Calorie_per_100gm__Maize_grain

UNITS: kilocalorie/gram

Kcal_per_100Gm__Edible_portion_of_Cereal[Barely] = Calorie_per_100gm__Barley_grain

UNITS: kilocalorie/gram

Kcal_per_100Gm__Edible_portion_of_Cereal[Rice] = Calorie_per_100gm__Rice__grain

UNITS: kilocalorie/gram

Kcal_per_100Gm__Edible_portion_of_Cereal[Sorghum] = Calorie_per_100gm__Sorghum__grain

UNITS: kilocalorie/gram

Kcal_per_100Gm__Edible_portion_of_Cereal[Millet] = Calorie_per_100gm__Millet__grain

UNITS: kilocalorie/gram

Kcal_per_100Gm__Edible_portion_of_Cereal[Oats] = Calorie_per_100gm__Oat__grain

UNITS: kilocalorie/gram

KG_in_thousand__Quintals = 100000

UNITS: kilogram/quintal

Ma =

*InitialEstimated_Expenditure_Share_of__Cereals_from_total_Budget[Maize]*Relative_Share_of_Cereals[Maize]*

Maize_for__Industrial_Processing = GRAPH(TIME)

(1995, 32.5), (1996, 12.0), (1997, 38.2), (1998, 58.0), (1999, 99.7), (2000, 94.0), (2001, 52.9), (2002, 255), (2003, 94.6), (2004, 127), (2005, 150), (2006, 200), (2007, 250), (2008, 450), (2009, 611), (2010, 327)

Maize_Kcal_share = GRAPH(TIME)

(2014, 0.25), (2018, 0.25), (2021, 0.26), (2025, 0.255)

Maize__Expenditure_Share = GRAPH(TIME)

(1995, 0.21), (1996, 0.2), (1997, 0.21), (1998, 0.21), (1999, 0.22), (2000, 0.21), (2001, 0.2), (2002, 0.16), (2003, 0.18), (2004, 0.19), (2005, 0.21), (2006, 0.21), (2007, 0.2), (2008, 0.19), (2009, 0.18), (2010, 0.16)

Maize__net_import = GRAPH(TIME)

(1995, 250), (1996, 210), (1997, 270), (1998, 380), (1999, 370), (2000, 280), (2001, 190), (2002, 60.0), (2003, 870), (2004, 250), (2005, 280), (2006, 610), (2007, 340), (2008, 730), (2009, 270), (2010, 200)

Meher_Annual_Cereal_Production[Tef] =

*Cereal_Cultivated__Area_in_thousand_Ha*Cultivation_Area_share_of_cereals[Tef]*Yield_Sector.Current_Yield[Tef]*

UNITS: quintal/year

*Meher_Annual_Cereal_Production[Wheat] = Cereal_Cultivated__Area_in_thousand_Ha*Cultivation_Area_share_of_cereals[Wheat]*Yield_Sector.Current_Yield[Wheat]*

UNITS: quintal/year

*Meher_Annual_Cereal_Production[Maize] = Cereal_Cultivated__Area_in_thousand_Ha*Cultivation_Area_share_of_cereals[Maize]*Yield_Sector.Current_Yield[Maize]*

UNITS: quintal/year

*Meher_Annual_Cereal_Production[Barely] = Cereal_Cultivated__Area_in_thousand_Ha*Cultivation_Area_share_of_cereals[Barely]*Yield_Sector.Current_Yield[Barely]*

UNITS: quintal/year

*Meher_Annual_Cereal_Production[Rice] = Cereal_Cultivated__Area_in_thousand_Ha*Cultivation_Area_share_of_cereals[Rice]*Yield_Sector.Current_Yield[Rice]*

UNITS: quintal/year

*Meher_Annual_Cereal_Production[Sorghum] = Cereal_Cultivated__Area_in_thousand_Ha*Cultivation_Area_share_of_cereals[Sorghum]*Yield_Sector.Current_Yield[Sorghum]*

UNITS: quintal/year

*Meher_Annual_Cereal_Production[Millet] = Cereal_Cultivated__Area_in_thousand_Ha*Cultivation_Area_share_of_cereals[Millet]*Yield_Sector.Current_Yield[Millet]*

UNITS: quintal/year

*Meher_Annual_Cereal_Production[Oats] = Cereal_Cultivated__Area_in_thousand_Ha*Cultivation_Area_share_of_cereals[Oats]*Yield_Sector.Current_Yield[Oats]*

UNITS: quintal/year

Meher_Annual_Production_for_Consumption_and_Sale[Tef] = Meher_Annual_Cereal_Production[Tef](1-Share_of__Cereal_for_seed_and_non_consumption)*

UNITS: quintal/year

Meher_Annual_Production_for_Consumption_and_Sale[Wheat] = Meher_Annual_Cereal_Production[Wheat](1-Share_of__Cereal_for_seed_and_non_consumption)*

UNITS: quintal/year

Meher_Annual_Production_for_Consumption_and_Sale[Maize] = Meher_Annual_Cereal_Production[Maize](1-Share_of__Cereal_for_seed_and_non_consumption)*

UNITS: quintal/year

Meher_Annual_Production_for_Consumption_and_Sale[Barely] =
Meher_Annual_Cereal_Production[Barely](1-Share_of__Cereal_for_seed_and_non_consumption)*

UNITS: quintal/year

Meher_Annual_Production_for_Consumption_and_Sale[Rice] = Meher_Annual_Cereal_Production[Rice](1-*
Share_of__Cereal_for_seed_and_non_consumption)

UNITS: quintal/year

Meher_Annual_Production_for_Consumption_and_Sale[Sorghum] =
Meher_Annual_Cereal_Production[Sorghum](1-Share_of__Cereal_for_seed_and_non_consumption)*

UNITS: quintal/year

Meher_Annual_Production_for_Consumption_and_Sale[Millet] =
Meher_Annual_Cereal_Production[Millet](1-Share_of__Cereal_for_seed_and_non_consumption)*

UNITS: quintal/year

Meher_Annual_Production_for_Consumption_and_Sale[Oats] = Meher_Annual_Cereal_Production[Oats](1-*
Share_of__Cereal_for_seed_and_non_consumption)

UNITS: quintal/year

Meher_Cereal__for_Sale_in_Market[Tef] = MAX(0,Meher__seasonal_Production[Tef]-
Post__Harvest_Loss[Tef])

Meher_Cereal__for_Sale_in_Market[Wheat] = MAX(0,Meher__seasonal_Production[Wheat]-
Post__Harvest_Loss[Wheat])

Meher_Cereal__for_Sale_in_Market[Maize] = MAX(0,Meher__seasonal_Production[Maize]-
Post__Harvest_Loss[Maize])

Meher_Cereal__for_Sale_in_Market[Barely] = MAX(0,Meher__seasonal_Production[Barely]-
Post__Harvest_Loss[Barely])

Meher_Cereal__for_Sale_in_Market[Rice] = MAX(0,Meher__seasonal_Production[Rice]-
Post__Harvest_Loss[Rice])

Meher_Cereal__for_Sale_in_Market[Sorghum] = MAX(0,Meher__seasonal_Production[Sorghum]-
Post__Harvest_Loss[Sorghum])

Meher_Cereal__for_Sale_in_Market[Millet] = MAX(0,Meher__seasonal_Production[Millet]-
Post__Harvest_Loss[Millet])

Meher_Cereal__for_Sale_in_Market[Oats] = MAX(0,Meher__seasonal_Production[Oats]-
Post__Harvest_Loss[Oats])

Meher__seasonal_Production[Tef] =
*Meher_Annual_Production_for_Consumption_and_Sale[Tef]*Seasonal__Distribution_of_production*

UNITS: quintal/year

Meher__seasonal_Production[Wheat] =
*Meher_Annual_Production_for_Consumption_and_Sale[Wheat]*Seasonal__Distribution_of_production*

UNITS: quintal/year

Meher_seasonal_Production[Maize] =
*Meher_Annual_Production_for_Consumption_and_Sale[Maize]*Seasonal_Distribution_of_production*

UNITS: quintal/year

Meher_seasonal_Production[Barely] =
*Meher_Annual_Production_for_Consumption_and_Sale[Barely]*Seasonal_Distribution_of_production*

UNITS: quintal/year

Meher_seasonal_Production[Rice] =
*Meher_Annual_Production_for_Consumption_and_Sale[Rice]*Seasonal_Distribution_of_production*

UNITS: quintal/year

Meher_seasonal_Production[Sorghum] =
*Meher_Annual_Production_for_Consumption_and_Sale[Sorghum]*Seasonal_Distribution_of_production*

UNITS: quintal/year

Meher_seasonal_Production[Millet] =
*Meher_Annual_Production_for_Consumption_and_Sale[Millet]*Seasonal_Distribution_of_production*

UNITS: quintal/year

Meher_seasonal_Production[Oats] =
*Meher_Annual_Production_for_Consumption_and_Sale[Oats]*Seasonal_Distribution_of_production*

UNITS: quintal/year

Mi =
*InitialEstimated_Expenditure_Share_of_Cereals_from_total_Budget[Millet]*Relative_Share_of_Cereals[Millet]*

Millet_for_Industrial_Processing = 0

Millet_Kcal_Share = GRAPH(TIME)

(2014, 0.008), (2018, 0.006), (2021, 0.004), (2025, 0.004)

Millet_net_import = GRAPH(TIME)

(1995, 0.00), (1996, 0.00), (1997, 0.00), (1998, 0.00), (1999, 0.00), (2000, 0.00), (2001, 0.00), (2002, 0.00),
(2003, 10.0), (2004, 0.00), (2005, 0.00), (2006, 0.00), (2007, 0.00), (2008, 0.00), (2009, 0.00)

Millet_Expnditure_Share = GRAPH(TIME)

(1995, 0.0338), (1996, 0.04), (1997, 0.047), (1998, 0.057), (1999, 0.047), (2000, 0.037), (2001, 0.038), (2002,
0.04), (2003, 0.033), (2004, 0.035), (2005, 0.036), (2006, 0.042), (2007, 0.044), (2008, 0.042), (2009, 0.038),
(2010, 0.02)

Months_in_a_year_Adjustment = counter(0,1)

UNITS: Unitless

National_Cumulative_Net_Adult_Equivalent_calorie_PC_per_day =
*Kcal_Net_Consumption_per_day_for_Adult*Population.Cumulative_Adult_Equivalent_Fraction_of_total_population*

UNITS: kilocalorie/day-person

*Net__Fallwing_Land = Conversion_of_Cultivated_Area_to_Temporary_fallow-
Conversion_of_Temporary__Fallow_toCereal_Cultivation_area*

Nmber_of_days__in_a_Year = 365

UNITS: days/year

Oa =

*InitialEstimated_Expenditure_Share_of__Cereals_from_total_Budget[Oats]*Relative_Share_of_Cereals[Oats]*

Oats_for__Industrial_Processing = 0

Oats_Kcal_share = GRAPH(TIME)

(2014, 0.002), (2018, 0.002), (2021, 0.001), (2025, 0.001)

Oats__Expenditure_Share = GRAPH(TIME)

*(1995, 0.0061), (1996, 0.0044), (1997, 0.0051), (1998, 0.0039), (1999, 0.0042), (2000, 0.0038), (2001, 0.0029),
(2002, 0.0026), (2003, 0.0028), (2004, 0.0041), (2005, 0.0036), (2006, 0.003), (2007, 0.003), (2008, 0.003),
(2009, 0.004), (2010, 0.002)*

Oats__net_import = GRAPH(TIME)

*(1995, 10.0), (1996, 10.0), (1997, 10.0), (1998, 0.00), (1999, 0.00), (2000, 0.00), (2001, 0.00), (2002, 0.00),
(2003, 0.00), (2004, 0.00), (2005, 0.00), (2006, 0.00), (2007, 0.00), (2008, 0.00), (2009, 0.00)*

PC_calorie_consumption_from_Barely_per_month =

percentage =

*EstimatedConsumption__Expenditure__Share_of_Tef+EstimatedConsumption__Expenditure__Share_of_Wheat
+EstimatedConsumption__Expenditure__Share_of_Maize+EstimatedConsumption__Expenditure__Share_of_B
arely+EstimatedConsumption__Expenditure__Share_of_Rice+Estimated_Consumption__Expenditure__Share_
of_Sorghum+EstimatedConsumption__Expenditure__Share_of_Millet+EstimatedConsumption__Expenditure__
Share_of_Oats*

Percentage_effect_of_productivity_on_PC_expenditure = 0.25

UNITS: Unitless

*Percieved_Investments__For_Inputs = SMTH1(Revenue__used_per_year,1)*Investment_share__for_Revenue*

UNITS: birr/year

Policy3_activated = if(Policy_Switch_3=1)and(time>Policy_Start_Time)then(1)else(0)

Policy_Start_Time = 2014

Policy_Switch_3 = 0

*Population_Nourished = If(Annual_Desired_net_Kcal_Consumption_PC>0)then
(Effective__Calories_per_year/Annual_Desired_net_Kcal_Consumption_PC)
else(Effective__Calories_per_year/(Annual_Desired_net_Kcal_Consumption_PC+0.000001))*

UNITS: people (person)

$Prevalence_of_Undernourishment = SMTH1(Prevalence_of_Undernourishment, 1, 0.64)$

UNITS: Unitless

$Prevalence_of_Undernourishment = MAX(0, Desired_Population_Nourished - Population_Nourished) / Desired_Population_Nourished$

UNITS: Unitless

$Price_Adjustment_Time = 1$

UNITS: year

$Rehablitable_fracton = 0.8$

UNITS: Unitless

$Rehablitable_Land = Non_Productive_Land_in_thousand_Ha * Rehablitable_fracton$

$Relative_cereal_price = Average_Cereal_Price / INIT(Average_Cereal_Price)$

$Relative_Fertilizer_Cost = Retailer_Dap_price_Birr_pe_Quintal / INIT(Retailer_Dap_price_Birr_pe_Quintal)$

$Relative_Prevalence_of_Undernourishment = Prevalence_of_Undernourishment / INIT(Prevalence_of_Undernourishment)$

UNITS: Unitless

$Relative_Road_Network = Rods_total_network_KM / INIT(Rods_total_network_KM)$

UNITS: Unitless

$Relative_Share_of_Cereals[Tef] = Share_of_Cereals[Tef] / INIT(Share_of_Cereals[Tef])$

$Relative_Share_of_Cereals[Wheat] = Share_of_Cereals[Wheat] / INIT(Share_of_Cereals[Wheat])$

$Relative_Share_of_Cereals[Maize] = Share_of_Cereals[Maize] / INIT(Share_of_Cereals[Maize])$

$Relative_Share_of_Cereals[Barely] = Share_of_Cereals[Barely] / INIT(Share_of_Cereals[Barely])$

$Relative_Share_of_Cereals[Rice] = Share_of_Cereals[Rice] / INIT(Share_of_Cereals[Rice])$

$Relative_Share_of_Cereals[Sorghum] = Share_of_Cereals[Sorghum] / INIT(Share_of_Cereals[Sorghum])$

$Relative_Share_of_Cereals[Millet] = Share_of_Cereals[Millet] / INIT(Share_of_Cereals[Millet])$

$Relative_Share_of_Cereals[Oats] = Share_of_Cereals[Oats] / INIT(Share_of_Cereals[Oats])$

$Relative_Fuel_Price = Fuel_Price_in_Birr / INIT(Fuel_Price_in_Birr)$

UNITS: Unitless

$Retailer_Dap_price_Birr_pe_Quintal = GRAPH(TIME)$

(1995, 164), (1996, 200), (1997, 255), (1998, 245), (1999, 264), (2000, 290), (2001, 273), (2002, 255), (2003, 258), (2004, 309), (2005, 364), (2006, 367), (2007, 384), (2008, 810), (2009, 703), (2010, 719)

$Retailer_Price_per_thousand_Quintal[Tef] =$
 $Producer_Price_per_000_Quin[Tef]*(1+Estimated_Markup_Fraction)*Effect_of_Fuel_Price_and_Road_net$
 $work_on_Retailer_Price$

UNITS: birr/quintal

$Retailer_Price_per_thousand_Quintal[Wheat] =$
 $Producer_Price_per_000_Quin[Wheat]*(1+Estimated_Markup_Fraction)*Effect_of_Fuel_Price_and_Road_n$
 $etwork_on_Retailer_Price$

UNITS: birr/quintal

$Retailer_Price_per_thousand_Quintal[Maize] =$
 $Producer_Price_per_000_Quin[Maize]*(1+Estimated_Markup_Fraction)*Effect_of_Fuel_Price_and_Road_n$
 $etwork_on_Retailer_Price$

UNITS: birr/quintal

$Retailer_Price_per_thousand_Quintal[Barely] =$
 $Producer_Price_per_000_Quin[Barely]*(1+Estimated_Markup_Fraction)*Effect_of_Fuel_Price_and_Road_n$
 $etwork_on_Retailer_Price$

UNITS: birr/quintal

$Retailer_Price_per_thousand_Quintal[Rice] =$
 $Producer_Price_per_000_Quin[Rice]*(1+Estimated_Markup_Fraction)*Effect_of_Fuel_Price_and_Road_net$
 $work_on_Retailer_Price$

UNITS: birr/quintal

$Retailer_Price_per_thousand_Quintal[Sorghum] =$
 $Producer_Price_per_000_Quin[Sorghum]*(1+Estimated_Markup_Fraction)*Effect_of_Fuel_Price_and_Ro$
 $d_network_on_Retailer_Price$

UNITS: birr/quintal

$Retailer_Price_per_thousand_Quintal[Millet] =$
 $Producer_Price_per_000_Quin[Millet]*(1+Estimated_Markup_Fraction)*Effect_of_Fuel_Price_and_Road_n$
 $etwork_on_Retailer_Price$

UNITS: birr/quintal

$Retailer_Price_per_thousand_Quintal[Oats] =$
 $Producer_Price_per_000_Quin[Oats]*(1+Estimated_Markup_Fraction)*Effect_of_Fuel_Price_and_Road_ne$
 $twork_on_Retailer_Price$

UNITS: birr/quintal

$Revenue_Consumption_Time = 1$

UNITS: years (yr)

$Ri =$
 $InitialEstimated_Expenditure_Share_of_Cereals_from_total_Budget[Rice]*Relative_Share_of_Cereals[Rice]$

$Rice_Kcal_Share = GRAPH(TIME)$

(2014, 0.03), (2018, 0.03), (2021, 0.01), (2025, 0.01)

Rice_for_Industrial_Processing = 0

Rice_net_import = GRAPH(TIME)

(1995, 20.0), (1996, 30.0), (1997, 40.0), (1998, 50.0), (1999, 90.0), (2000, 30.0), (2001, 50.0), (2002, 120),
(2003, 210), (2004, 180), (2005, 180), (2006, 310), (2007, 450), (2008, 230), (2009, 310), (2010, 280)

Rice_Expenditure_Share = GRAPH(TIME)

(1995, 0.00164), (1996, 0.0024), (1997, 0.0043), (1998, 0.0044), (1999, 0.0077), (2000, 0.002), (2001, 0.0135),
(2002, 0.01), (2003, 0.013), (2004, 0.0113), (2005, 0.0148), (2006, 0.0157), (2007, 0.0512), (2008, 0.0561),
(2009, 0.0556), (2010, 0.06)

Rods_total_network_KM = GRAPH(TIME)

(1995, 23442), (1996, 23832), (1997, 23832), (1998, 26062), (1999, 28652), (2000, 29571), (2001, 30000),
(2002, 33297), (2003, 33856), (2004, 36469), (2005, 42370), (2006, 40244), (2007, 44359), (2008, 45000),
(2009, 47000), (2010, 49000)

UNITS: kilometer

Sale_Cereals_Shipment[Tef] =

MIN(*Meher_Cereal_for_Sale_in_Market[Tef]*, *Consumption_Shipment_of_cereal[Tef]*)**Fraction_For_Sale*

UNITS: quintal/year

Sale_Cereals_Shipment[Wheat] =

MIN(*Meher_Cereal_for_Sale_in_Market[Wheat]*, *Consumption_Shipment_of_cereal[Wheat]*)**Fraction_For_Sale*

UNITS: quintal/year

Sale_Cereals_Shipment[Maize] =

MIN(*Meher_Cereal_for_Sale_in_Market[Maize]*, *Consumption_Shipment_of_cereal[Maize]*)**Fraction_For_Sale*

UNITS: quintal/year

Sale_Cereals_Shipment[Barely] =

MIN(*Meher_Cereal_for_Sale_in_Market[Barely]*, *Consumption_Shipment_of_cereal[Barely]*)**Fraction_For_Sale*

UNITS: quintal/year

Sale_Cereals_Shipment[Rice] =

MIN(*Meher_Cereal_for_Sale_in_Market[Rice]*, *Consumption_Shipment_of_cereal[Rice]*)**Fraction_For_Sale*

UNITS: quintal/year

Sale_Cereals_Shipment[Sorghum] =

MIN(*Meher_Cereal_for_Sale_in_Market[Sorghum]*, *Consumption_Shipment_of_cereal[Sorghum]*)**Fraction_For_Sale*

UNITS: quintal/year

$Sale_Cereals_Shipment[Millet] =$
 $MIN(Meher_Cereal_for_Sale_in_Market[Millet], Consumption_Shipment_of_cereal[Millet])*Fraction_For_Sale$

UNITS: quintal/year

$Sale_Cereals_Shipment[Oats] =$
 $MIN(Meher_Cereal_for_Sale_in_Market[Oats], Consumption_Shipment_of_cereal[Oats])*Fraction_For_Sale$

UNITS: quintal/year

$Seasonal_Distribution_of_production = GRAPH(Months_in_a_year_Adjustment)$

(0.00, 2.94), (0.0909, 2.77), (0.182, 0.84), (0.273, 0.00), (0.364, 0.00), (0.455, 0.00), (0.545, 0.00), (0.636, 0.015), (0.727, 0.015), (0.818, 1.61), (0.909, 2.79), (1.00, 2.94)

UNITS: Unitless

$Share_of_Cereals[Tef] = All_cereal_Yearly_Available[Tef]/Total_Cereal$

$Share_of_Cereals[Wheat] = All_cereal_Yearly_Available[Wheat]/Total_Cereal$

$Share_of_Cereals[Maize] = All_cereal_Yearly_Available[Maize]/Total_Cereal$

$Share_of_Cereals[Barely] = All_cereal_Yearly_Available[Barely]/Total_Cereal$

$Share_of_Cereals[Rice] = All_cereal_Yearly_Available[Rice]/Total_Cereal$

$Share_of_Cereals[Sorghum] = All_cereal_Yearly_Available[Sorghum]/Total_Cereal$

$Share_of_Cereals[Millet] = All_cereal_Yearly_Available[Millet]/Total_Cereal$

$Share_of_Cereals[Oats] = All_cereal_Yearly_Available[Oats]/Total_Cereal$

$Share_of_cereal_in_daily_Kcal_consumption = GRAPH(TIME)$

(1995, 0.673), (2000, 0.639), (2005, 0.618), (2010, 0.579)

UNITS: Unitless

$Share_of_Producers_using_Fertilizer = 0.85$

UNITS: Unitless

$Share_of_Cereal_for_seed_and_non_consumption = 0.17$

UNITS: Unitless

$Share_of_investment_for_input[Fertilizer] = 0.94$

UNITS: Unitless

$Share_of_investment_for_input[Improved_Seed] = 0.06$

UNITS: Unitless

$Shipment_Adjtime = 1/96$

UNITS: year

So =

*InitialEstimated_Expenditure_Share_of__Cereals_from_total_Budget[Sorghum]*Relative_Share_of_Cereals[Sorghum]*

Sorghum_for_industrial_Processing = 0

Sorghum_Kcal_share = GRAPH(TIME)

(2014, 0.19), (2018, 0.17), (2021, 0.17), (2025, 0.16)

Sorghum__net_import = GRAPH(TIME)

(1995, 1000), (1996, 500), (1997, 100), (1998, 500), (1999, 490), (2000, 60.0), (2001, 90.0), (2003, 90.0), (2004, 230), (2005, 30.0), (2006, -100), (2007, 0.00), (2008, 140), (2009, 2510), (2010, 2000)

Sorghum__Expenditure_Share = GRAPH(TIME)

(1995, 0.14), (1996, 0.15), (1997, 0.11), (1998, 0.11), (1999, 0.102), (2000, 0.101), (2001, 0.11), (2002, 0.121), (2003, 0.112), (2004, 0.111), (2005, 0.113), (2006, 0.113), (2007, 0.124), (2008, 0.128), (2009, 0.18), (2010, 0.18)

Stock_adjustment_fraction = 0.28

UNITS: per year (1/yr)

Total_Average_PC_cereal_consumption_per_month_in_Gm =

*Average_PC_Barely_Consumption_per_month_in_Gm+Average_PC_Maize__Consumption_per_month_in_Gm
+Average_PC_Millet__per_month_in_Gm+Average_PC_Oats_Consumption_per_month_in_Gm+Average_PC
C_Rice_Consumption_per_month_in_Gm+Average_PC_Sorghum_Consumption_per_month_in_Gm+Average_
PC_Tef_Consumption_per_month__in_Gm+Average_PC_wheat__Consumption_per_month_in_Gm*

Te =

*InitialEstimated_Expenditure_Share_of__Cereals_from_total_Budget[Tef]*Relative_Share_of_Cereals[Tef]*

Tefe_KCAL_share = GRAPH(TIME)

(2014, 0.22), (2018, 0.225), (2021, 0.24), (2025, 0.24)

Tef_for_Industrial_Processing = 0

Tef__net_import = GRAPH(TIME)

(1995, 0.00), (1996, 0.00), (1997, 0.00), (1998, 0.00), (1999, 0.00), (2000, 0.00), (2001, 0.00), (2002, 0.00), (2003, 0.00), (2004, 0.00), (2005, 0.00), (2006, 0.00), (2007, 0.00), (2008, 0.00), (2009, 0.00), (2010, 0.00)

Tef__Expenditure_Share = GRAPH(TIME)

(1995, 0.335), (1996, 0.375), (1997, 0.335), (1998, 0.345), (1999, 0.345), (2000, 0.285), (2001, 0.285), (2002, 0.315), (2003, 0.265), (2004, 0.315), (2005, 0.295), (2006, 0.305), (2007, 0.335), (2008, 0.305), (2009, 0.29), (2010, 0.29)

Time_to_rehabilitate = 2000

UNITS: year

Total_Calories_per_month_per_person =
PC_calorie_consumption_from_Barely_per_month+PC_calorie_consumption_from_Maize_per_month+PC_calorie_consumption_from_Millet_per_month+PC_calorie_consumption_from_Oats_per_month+PC_calorie_consumption_from_Rice_per_month+PC_calorie_consumption_from_Sorghum_per_month+PC_calorie_consumption_from_Tef_per_month+PC_calorie_consumption_from_Wheat_per_month

Total_Cereal =
All_cereal__Yearly_Available[Tef]+All_cereal__Yearly_Available[Wheat]+All_cereal__Yearly_Available[Maize]+All_cereal__Yearly_Available[Barely]+All_cereal__Yearly_Available[Rice]+All_cereal__Yearly_Available[Sorghum]+All_cereal__Yearly_Available[Millet]+All_cereal__Yearly_Available[Oats]

Total_Expenditure_for_cereal =
*Cereal_price_1995_per_Gm[Tef]*Average_PC_Tef_Consumption_per_month_in_Gm_2+Cereal_price_1995_per_Gm[Wheat]*Average_PC_wheat_Consumption_per_month_in_Gm_2+Cereal_price_1995_per_Gm[Maize]*Average_PC_Maize_Consumption_per_month_in_Gm_2+Cereal_price_1995_per_Gm[Barely]*Average_PC_Barely_Consumption_per_month_in_Gm_2+Cereal_price_1995_per_Gm[Rice]*Average_PC_Rice_Consumption_per_month_in_Gm_2+Cereal_price_1995_per_Gm[Sorghum]*Average_PC_Sorghum_Consumption_per_month_in_Gm_2+Cereal_price_1995_per_Gm[Millet]*Average_PC_Millet_per_month_in_Gm_2+Cereal_price_1995_per_Gm[Oats]*Average_PC_Oats_Consumption_per_month_in_Gm_2*

Total_fallowed_land_per_year = Conversion_of_Cultivated_Area_to_Temporary_fallow+Degradation_Rate

UNITS: hectares/year

Total_Inventory =
Cereal_Inventory__In_000_Quin[Tef]+Cereal_Inventory__In_000_Quin[Wheat]+Cereal_Inventory__In_000_Quin[Maize]+Cereal_Inventory__In_000_Quin[Barely]+Cereal_Inventory__In_000_Quin[Rice]+Cereal_Inventory__In_000_Quin[Sorghum]+Cereal_Inventory__In_000_Quin[Millet]+Cereal_Inventory__In_000_Quin[Oats]

UNITS: quintal

Unit_adjustment_100Gm = 100

Unit_Adjustment_thousand = 1000

UNITS: Unitless

Wh =
*InitialEstimated_Expenditure_Share_of_Cereals_from_total_Budget[Wheat]*Relative_Share_of_Cereals[Wheat]*

Wheat_for__Industrial_Processing = GRAPH(TIME)

(1995, 1837), (1996, 2074), (1997, 1444), (1998, 2261), (1999, 2603), (2000, 1903), (2001, 1990), (2002, 2136), (2003, 2056), (2004, 1811), (2005, 3000), (2006, 3500), (2007, 4000), (2008, 4500), (2009, 5444), (2010, 5912)

wheat_Kcal_share = GRAPH(TIME)

(2014, 0.21), (2018, 0.21), (2021, 0.23), (2025, 0.23)

Wheat__Expenditure_Share = GRAPH(TIME)

(1995, 0.19), (1996, 0.16), (1997, 0.21), (1998, 0.21), (1999, 0.225), (2000, 0.29), (2001, 0.28), (2002, 0.23), (2003, 0.31), (2004, 0.255), (2005, 0.245), (2006, 0.225), (2007, 0.2), (2008, 0.24), (2009, 0.24), (2010, 0.18)

Wheat__net_import = GRAPH(TIME)

(1995, 5140), (1996, 3710), (1997, 2320), (1998, 4970), (1999, 5960), (2000, 12270), (2001, 10660), (2002, 6750), (2003, 16830), (2004, 5970), (2005, 8710), (2006, 5340), (2007, 6050), (2008, 11180), (2009, 18540), (2010, 12540)

Land Degradation series:

$High_Productive_Cultivated_Land(t) = High_Productive_Cultivated_Land(t - dt) + (Becoming_High_Productive_Land + Productive_fallowed_To_Cultivated + Soil_rehabilitation_S_to_H - Becoming_suitable_Land - Becoming_Productive_Fallow) * dt$

$INIT\ High_Productive_Cultivated_Land = 2143.59$

UNITS: hectare

INFLOWS:

$Becoming_High_Productive_Land = .Conversion_Rate_of_Arable_to_cultivation$

UNITS: hectares/yr

$Productive_fallowed_To_Cultivated = Productive_fallowed_Land/Following_Time$

UNITS: hectares/yr

$Soil_rehabilitation_S_to_H = (1 - Policy1_activated)*0 + Policy1_activated*(Suitable_land/AverageTime_of_Rehabilitation_S_to_HP)$

UNITS: hectares/yr

OUTFLOWS:

$Becoming_suitable_Land = High_Productive_Cultivated_Land/Productive_Land_Life_Time$

UNITS: hectares/yr

$Becoming_Productive_Fallow = High_Productive_Cultivated_Land*Effect_of_rainfall_on_Cultivation_land_following_fraction$

UNITS: hectares/yr

$Marginal_suitable_Land(t) = Marginal_suitable_Land(t - dt) + (Becoming_marginal_suitable_Land + Marginal_fallow_to_cultivated + Soil_rehabilitation_N_to_MA - Becoming_non_suitable_land - Becoming_MarginalFallowed - Soil_rehabilitation_MA_to_MO) * dt$

$INIT\ Marginal_suitable_Land = 512.42$

UNITS: hectare

INFLOWS:

$Becoming_marginal_suitable_Land = Moderatly_suitable_Land/Moderatly_Suitable_Land_Life_Time$

UNITS: hectares/yr

$Marginal_fallow_to_cultivated = Marginal_fallow_land/Following_Time$

UNITS: hectares/yr

$Soil_rehabilitation_N_to_MA = (1 - Policy1_activated)*0 + Policy1_activated*(Non_suitable_Land/Average_Time_of_Rehabilitation_Nto_MA)$

UNITS: hectares/yr

OUTFLOWS:

$Becoming_non_suitable_land = Marginal_suitable_Land/Marginal_Suitable_Land_Life_Time$

UNITS: hectares/yr

$Becoming_MarginalFallowed = Marginal_suitable_Land*(Following_fraction + Effect_of_rainfall_on_Cultivation_land_following_fraction)$

UNITS: hectares/yr

$Soil_rehabilitation_MA_to_MO = (1 - Policy1_activated)*0 + Policy1_activated*(Marginal_suitable_Land/Average_Time_of_Rehabilitation_MA_to_MO)$

UNITS: hectares/yr

$Moderatly_suitable_Land(t) = Moderatly_suitable_Land(t - dt) + (Becoming_Moderatly_suitable_land + Moderatly_fallow_to_Cultivated + Soil_rehabilitation_MA_to_MO - Becoming_marginal_suitable_Land - Becoming_Moderatly_Fallowed - Soil_rehabilit_ation_MO_to_S) * dt$

INIT Moderatly_suitable_Land = 1144.24

UNITS: hectare

INFLOWS:

$Becoming_Moderatly_suitable_land = Suitable_land/Suitable_Land_Life_time$

UNITS: hectares/yr

$Moderatly_fallow_to_Cultivated = Moderatly_Fallowed_land/Following_Time$

UNITS: hectares/yr

$Soil_rehabilitation_MA_to_MO = (1 - Policy1_activated)*0 + Policy1_activated*(Marginal_suitable_Land/Average_Time_of_Rehabilitation_MA_to_MO)$

UNITS: hectares/yr

OUTFLOWS:

$Becoming_marginal_suitable_Land = Moderatly_suitable_Land/Moderatly_Suitable_Land_Life_Time$

UNITS: hectares/yr

$Becoming_Moderatly_Fallowed = Moderatly_suitable_Land*(Effect_of_rainfall_on_Cultivation_land_following_fraction + Following_fraction)$

UNITS: hectares/yr

$Soil_rehabilit_ation_MO_to_S = (1 - Policy1_activated)*0 + Policy1_activated*(Moderately_suitable_Land/Average_Time_of_Rehabilitation_MO_to_S)$

UNITS: hectares/yr

$Non_suitable_Fallow_Land(t) = Non_suitable_Fallow_Land(t - dt) + (Non_suitable_to_Fallow - Non_suitable_Fallow_to_Cultivated) * dt$

INIT Non_suitable_fallow_Land = 370.5

UNITS: hectare

INFLOWS:

$Non_suitable_to_Fallow = Non_suitable_Land*(Following_fraction + Effect_of_rainfall_on_Cultivation_land_following_fraction)$

UNITS: hectares/yr

OUTFLOWS:

$Non_suitable_Fallow_to_Cultivated = Non_suitable_Fallow_Land/Following_Time$

UNITS: hectares/yr

$Productive_fallowed_Land(t) = Productive_fallowed_Land(t - dt) + (Becoming_Productive_Fallow - Productive_fallowed_To_Cultivated) * dt$

INIT Productive_fallowed_Land = 100.05

UNITS: hectare

INFLOWS:

$Becoming_Productive_Fallow = High_Productive_Cultivated_Land*Effect_of_rainfall_on_Cultivation_land_following_fraction$

UNITS: hectares/yr

OUTFLOWS:

$Productive_fallowed_To_Cultivated = Productive_fallowed_Land/Following_Time$

UNITS: hectares/yr

$Suitable_land(t) = Suitable_land(t - dt) + (Becoming_suitable_Land + Suitable_fallowed_To_Cultivated + Soil_rehabilit_ation_MO_to_S - Becoming_Moderately_suitable_land - Becoming_Suitable_Fallowed - Soil_rehabilitation_S_to_H) * dt$

INIT Suitable_land = 2334.83

UNITS: hectare

INFLOWS:

$Becoming_suitable_Land = High_Productive_Cultivated_Land/Productive_Land_Life_Time$

UNITS: hectares/yr

$Suitable_followed_To_Cultivated = Suitable_followed_Land/Following_Time$

UNITS: hectares/yr

$Soil_rehabilit_ation_MO_to_S = (1 - PolicyI_activated)*0 + PolicyI_activated*(Moderatly_suitable_Land/Average_Time_of_Rehabilitation_MO_to_S)$

UNITS: hectares/yr

OUTFLOWS:

$Becoming_Moderatly_suitable_land = Suitable_land/Suitable_Land_Life_time$

UNITS: hectares/yr

$Becoming_Suitable_Fallowed = Suitable_land*(Following_fraction + Effect_of_rainfall_on_Cultivation_land_fallowing_fraction)$

UNITS: hectares/yr

$Soil_rehabilitation_S_to_H = (1 - PolicyI_activated)*0 + PolicyI_activated*(Suitable_land/AverageTime_of_Rehabilitation_S_to_HP)$

UNITS: hectares/yr

$Cultivation_land_under_soil_conservation(t) = Cultivation_land_under_soil_conservation(t - dt) + (Starting_rate - Completion_Rate) * dt$

INIT Cultivation_land_under_soil_conservation = 100

UNITS: hectare stonebund

INFLOWS:

$Starting_rate = (1 - PolicyI_activated)*0 + PolicyI_activated*MIN(Cultivation_Area_Adjustmentfor_conservation, Expected_Capacity_land_conservation)$

UNITS: hectare stonebund/yr

OUTFLOWS:

$Completion_Rate = PolicyI_activated*Cultivation_land_under_soil_conservation/Construction_Time$

UNITS: hectare stonebund/yr

$Functioning_Conserved_Ston_bund(t) = Functioning_Conserved_Ston_bund(t - dt) + (Completion_Rate - Depretiation_Rate) * dt$

INIT Functioning_Conserved_Ston_bund = 100

UNITS: hectare stonebund

INFLOWS:

$Completion_Rate = PolicyI_activated*Cultivation_land_under_soil_conservation/Construction_Time$

UNITS: hectare stonebund/yr

OUTFLOWS:

$$\text{Depretiation_Rate} = \text{Policy1_activated} * \text{Functioning_Conserved_Ston_bund} / \text{Depretiation_Time}$$

UNITS: hectare stonebund/yr

$$\text{Marginal_fallow_land}(t) = \text{Marginal_fallow_land}(t - dt) + (\text{Becoming_MarginalFallowed} - \text{Marginal_fallow_to_cultivated}) * dt$$

$$\text{INIT Marginal_fallow_land} = 197.27$$

UNITS: hectare

INFLOWS:

$$\text{Becoming_MarginalFallowed} = \text{Marginal_suitable_Land} * (\text{Following_fraction} + \text{Effect_of_rainfall_on_Cultivation_land_following_fraction})$$

UNITS: hectares/yr

OUTFLOWS:

$$\text{Marginal_fallow_to_cultivated} = \text{Marginal_fallow_land} / \text{Following_Time}$$

UNITS: hectares/yr

$$\text{Moderatly_Fallowed_land}(t) = \text{Moderatly_Fallowed_land}(t - dt) + (\text{Becoming_Moderatly_Fallowed} - \text{Moderatly_fallow_to_Cultivated}) * dt$$

$$\text{INIT Moderatly_Fallowed_land} = 192.7$$

UNITS: hectare

INFLOWS:

$$\text{Becoming_Moderatly_Fallowed} = \text{Moderatly_suitable_Land} * (\text{Effect_of_rainfall_on_Cultivation_land_following_fraction} + \text{Following_fraction})$$

UNITS: hectares/yr

OUTFLOWS:

$$\text{Moderatly_fallow_to_Cultivated} = \text{Moderatly_Fallowed_land} / \text{Following_Time}$$

UNITS: hectares/yr

$$\text{Non_suitable_Land}(t) = \text{Non_suitable_Land}(t - dt) + (\text{Becoming_non_suitable_land} + \text{Non_suitable_Fallw_to_Caltivated} - \text{Becoming_non_Fetil_Land} - \text{Non_suitable_to_Fallow} - \text{Soil_rehabilitation_N_to_MA}) * dt$$

$$\text{INIT Non_suitable_Land} = 500.15$$

UNITS: hectare

INFLOWS:

$$\text{Becoming_non_suitable_land} = \text{Marginal_suitable_Land} / \text{Marginal_Suitable_Land_Life_Time}$$

UNITS: hectares/yr

$Non_suitable_Fallow_to_Cultivated = Non_suitable_Fallow_Land / Fallowing_Time$

UNITS: hectares/yr

OUTFLOWS:

$Becoming_non_Fertil_Land = Non_suitable_Land / Non_suitable_Land_Life_Time$

UNITS: hectares/yr

$Non_suitable_to_Fallow =$

$Non_suitable_Land * (Fallowing_fraction + Effect_of_rainfall_on_Cultivation_land_following_fraction)$

UNITS: hectares/yr

$Soil_rehabilitation_N_to_MA = (1 -$

$Policy1_activated) * 0 + Policy1_activated * (Non_suitable_Land / Average_Time_of_Rehabilitation_Nto_MA)$

UNITS: hectares/yr

$Suitable_fallowed_Land(t) = Suitable_fallowed_Land(t - dt) + (Becoming_Suitable_Fallowed - Suitable_fallowed_To_Cultivated) * dt$

INIT Suitable_fallowed_Land = 200.05

UNITS: hectare

INFLOWS:

$Becoming_Suitable_Fallowed =$

$Suitable_land * (Fallowing_fraction + Effect_of_rainfall_on_Cultivation_land_following_fraction)$

UNITS: hectares/yr

OUTFLOWS:

$Suitable_fallowed_To_Cultivated = Suitable_fallowed_Land / Fallowing_Time$

UNITS: hectares/yr

$AverageTime_of_Rehabilitation_S_to_HP =$

$Minimum_Topsoil_Depth_gap_High_S_and_HP / Average_Soil_depth_formation_rate$

$Average_Net_Top_Soil_Depth_Loss = (1 -$

$Policy1_activated) * Initial_net_Topsoil_Loss_Rate + Policy1_activated * Initial_net_Topsoil_Loss_Rate * Effect_of_Soil_conservation_coverage_ont_Top_soil_loss_rate$

UNITS: centimeter/year

$Average_soil_conservation_adjustment_time = 1$

UNITS: year

$Average_Soil_depth_formation_rate = 0.02$

$Average_Time_of_Rehabilitation_MA_to_MO =$

$Minimum_Topsoil_Depth_gap_MA_and_MO / Average_Soil_depth_formation_rate$

Average_Time_of_Rehabilitation_Nto_MA =
Minimum_Topsoil_Depth_Gap_N_anAand/Average_Soil_depth_formation_rate

Average_Time_of_Rehabilitation_MO_to_S =
Minimum_Topsoil_Depth_Gap_MO_and_S/Average_Soil_depth_formation_rate

Becoming_fallow_Total =
Becoming_Suitable_Fallowed+Becoming_Moderately_Fallowed+Non_suitable_to_Fallow+Becoming_MarginalFallowed

Construction_Time = 1

UNITS: year

Critical_Maximum_Topsoil_Depth = 90

UNITS: centimeter

Critical_Minimum_Depth = 18

UNITS: centimeter

*Cultivation_Area_Adjustmentfor_conservation = MAX(0,(Functioning_Conserved_Ston_bund-
Percieved_Desied_Land_for_Soil_conservation*Stonbund_unit)/Average_soil_conservation_adjustment_time)+
SMTH1(Depretiation_Rate,1)*

UNITS: hectare per year

Depretiation_Time = 7

UNITS: year

Depth_Gap = Maximum_Potential_Top_soil_Depth-Critical_Maximum_Topsoil_Depth

UNITS: centimeter

DesiredConstructed_stone_bund_per_year =
*Stone_bund_per_HA*Percieved_Desied_Land_for_Soil_conservation*

UNITS: hectare stonebund/year

Effect_of_rainfall_on_Cultivation_land_following_fraction =
GRAPH(Yield_Sector.AverageMeher_rainfall_distribution)

*(0.00, 1.00), (14.3, 0.999), (28.6, 0.7), (42.9, 0.6), (57.1, 0.55), (71.4, 0.51), (85.7, 0.45), (100, 0.42), (114, 0.41),
(129, 0.405), (143, 0.38), (157, 0.3), (171, 0.24), (186, 0.14), (200, 0.02), (214, 0.09), (229, 0.12), (243, 0.25),
(257, 0.35), (271, 0.4), (286, 0.5), (300, 0.6), (314, 0.7), (329, 0.75), (343, 0.8), (357, 0.85), (371, 0.9), (386,
0.95), (400, 0.99), (414, 0.99), (429, 1.00), (443, 1.00), (457, 1.00), (471, 1.00), (486, 1.00), (500, 1.00), (514,
1.00), (529, 1.00), (543, 1.00), (557, 1.00), (571, 1.00), (586, 1.00), (600, 1.00), (614, 1.00), (629, 1.00), (643,
1.00), (657, 1.00), (671, 1.00), (686, 1.00), (700, 1.00), (714, 1.00), (729, 1.00), (743, 1.00), (757, 1.00), (771,
1.00), (786, 1.00), (800, 1.00), (814, 1.00), (829, 1.00), (843, 1.00), (857, 1.00), (871, 1.00), (886, 1.00), (900,
1.00), (914, 1.00), (929, 1.00), (943, 1.00), (957, 1.00), (971, 1.00), (986, 1.00), (1000, 1.00)*

Effect_of_rainfall_on_following_land_fraction = GRAPH(TIME)

*(120, 0.415), (134, 0.405), (148, 0.36), (162, 0.28), (175, 0.22), (189, 0.15), (203, 0.025), (217, 0.1), (231,
0.135), (245, 0.2), (258, 0.25), (272, 0.3), (286, 0.4), (300, 0.9)*

Effect_of_Soil_conservation_coverage_ont_Top_soil_loss_rate = GRAPH(*Soil_conservation__Coverage*)
(0.00, 1.00), (0.1, 0.94), (0.2, 0.799), (0.3, 0.639), (0.4, 0.31), (0.5, 0.153), (0.6, 0.0646), (0.7, 0.0272), (0.8, 0.0159), (0.9, 0.0127), (1.00, 0.00952)

UNITS: Unitless

Expected_Capacity_land_conservation =
*DesiredConstructed__stone_bund_per_year*Expected__share_desired__conservation_land/Stone_bund_per_H*
A

UNITS: hectare stone/yr

Expected__share_desired__conservation_land = GRAPH(*TIME*)
(2014, 0.15), (2018, 0.35), (2022, 0.65), (2026, 0.85), (2030, 1.00)

UNITS: Unitless

Fallowing__fraction = 0.03*(1-
PolicyI_activated)+*PolicyI_activated**0.03*DELAY3(*Effect_of_Soil_conservation_coverage_ont_Top_soil_loss_rate*,5)

UNITS: per year (1/yr)

Fallowing__Time = 2.5

UNITS: year

Fallow_to_Cultivation_Total =
Suitable_fallowed__To_Cultivated+*moderatly_fallow_to_Cultivated*+*Marginal_fallow__to_cultivated*+*Non_suitable__Fallw_to_Caltivated*

Fraction_of_Conservation_needy_land_of_the_potential_area = 0.85

UNITS: Unitless

Initial_net_Topsoil__Loss_Rate = 0.4

UNITS: centimeter/year

Intial_fallowed_land = 860.57

UNITS: hectare

Marginal_SuitableTopSoil_Depth_Gap = *Maximum_Severly_Shallow__Topsoil_Depth*-
Minimum_Marginal_Suitable_Topsoil_Depth

Marginal_Suitable_Land_Life_Time =
Marginal_SuitableTopSoil_Depth_Gap/Average_Net_Top_Soil_Depth_Loss

UNITS: year

Maximum_Depth_suitable_Topsoil = 89

UNITS: centimeter

Maximum_Moderate_suitable__Topsoil_Depth = 71

UNITS: centimeter

Maximum_non_suitable__Topsoil_Depth = 35

UNITS: centimeter

Maximum_Potential_Top__soil_Depth = 130

UNITS: centimeter

Maximum_Severly_Shallow__Topsoil_Depth = 53

UNITS: centimeter

Minimum_Marginal_Suitable_Topsoil_Depth = 36

UNITS: centimeter

Minimum_Moderate_suitable_Topsoil_Depth = 54

UNITS: centimeter

Minimum_suitable__Topsoil_Depth = 72

UNITS: centimeter

Minimum_Topsoil_Depth_gap_High_S_and_HP = 18

Minimum_Topsoil_Depth_Gap_MO_and_S = 18

Minimum_Topsoil_Depth_Gap_N_anAand = 18

Minimum_Topsoil_Depth_gap_MA_and_MO = 18

*ModerateTopSoil_Depth_Gap = Maximum_Moderate_suitable__Topsoil_Depth-
Minimum_Moderate_suitable_Topsoil_Depth*

Moderatly_Suitable__Land_Life_Time = ModerateTopSoil_Depth_Gap/Average_Net_Top_Soil_Depth_Loss

UNITS: year

Non_suitable__Land_Life_Time = non_suitable__TopSoil_Depth_Gap/Average_Net_Top_Soil_Depth_Loss

UNITS: year

non_suitable__TopSoil_Depth_Gap = Maximum_non_suitable__Topsoil_Depth-Critical_Minimum__Depth

UNITS: centimeter

Percentage_of_high_Productive_Land = High_Productive_Cultivated_Land/Total_Cultivated_Land

percentage_of__Marginal_Suitable_Land = Marginal_suitable__Land/Total_Cultivated_Land

percentage_of__Moderatly_Suitable_Land = Moderatly_suitable_Land/Total_Cultivated_Land

percentage_of__Non_Suitable_Land = Non_suitable_Land/Total_Cultivated_Land

percentage_of__Suitable_Land = Suitable_land/Total_Cultivated_Land

Percieved_Desied_Land_for_Soil_conservation =
*SMTH3((Total__potential_cultivation_area*Fraction_of_Conservation_needy_land_of_the_potential_area),2)*

UNITS: hectare

Policy1_activated = *if(Policy_switch1=1)and(time>Policy_Start_Time)then(1)else(0)*

Policy_Start_Time = 2014

Policy_switch1 = 0

Productive_Land__Life_Time = *Depth_Gap/Average_Net_Top_Soil_Depth_Loss*

UNITS: year

Soil_conservation__Coverage =
(Functioning_Conserved_Ston_bund/Unit_adjustment_stone_bund)/Percieved_Desied_Land_for_Soil_conservation

UNITS: Unitless

Stonbund_unit = 1

UNITS: stonebund

Stone_bund_per_HA = *Width_of_one_Ha/Stone_bund_spacing*

UNITS: Unitless

Stone_bund_spacing = 10

UNITS: meter

suitableTop_Soil_Depth_Gap = *Maximum_Depth_suitable_Topsoil-Minimum_suitable__Topsoil_Depth*

UNITS: centimeter

Suitable_Land_Life_time = *suitableTop_Soil_Depth_Gap/Average_Net_Top_Soil_Depth_Loss*

UNITS: year

Total_Cultivated_Land =

High_Productive_Cultivated_Land+Suitable_land+Moderatly_suitable_Land+Marginal_suitable__Land+Non__suitable_Land

Total__potential_cultivation_area =

High_Productive_Cultivated_Land+Suitable_land+Moderatly_suitable_Land+Marginal_suitable__Land+Non__suitable_Land+Intial_fallowed_land

UNITS: hectare

Unit_adjustment_stone_bund = 1

UNITS: stonebund

Width_of_one_Ha = 100

UNITS: meter

DOCUMENT: meter

Population:

$Child_population(t) = Child_population(t - dt) + (Birth_Rate - Becaming_Schoole_age - Child_population_Death_Rate - Child_Net_Migration) * dt$

INIT Child__population = 10195000

UNITS: people (person)

INFLOWS:

Birth_Rate =

$IF(TIME < 2010) THEN (Female_fertile_population * Total_fertility_rate / fertile_period) ELSE (Female_fertile_population * Forcasted_Total_Fertility / fertile_period)$

UNITS: person/yr

OUTFLOWS:

$Becaming_Schoole_age = Child_population / Child_duration$

UNITS: person/yr

$Child_population_Death_Rate = Child_population * Chiled_death_fraction_Adjustment$

UNITS: person/yr

$Child_Net_Migration = Child_population * Net_Migration_Fraction$

UNITS: person/yr

$Elderly_population(t) = Elderly_population(t - dt) + (Becoming_Elderly - Elderly_Death_Rate - Elderly_Net_migration) * dt$

INIT Elderly__population = 500000

UNITS: people (person)

INFLOWS:

$Becoming_Elderly = Fertile_Age_population / Fertile_Age_Duration$

UNITS: person/yr

OUTFLOWS:

$Elderly_Death_Rate = Elderly_population * Elderly_death_fraction_Adjustment$

UNITS: person/yr

$Elderly_Net_migration = Elderly_population * Net_Migration_Fraction$

UNITS: person/yr

$Fertile_age_15_to_30(t) = Fertile_age_15_to_30(t - dt) + (Becoming_Age_15_t0_30 - Becoming_Age_30_plus) * dt$

INIT Fertile_age_15_to_30 = 15857400

UNITS: people (person)

INFLOWS:

$Becoming_Age_15_t0_30 = Becaming_Fertile_age - (Fertile_age_15_to_30 * Fertile_age_death_fraction_Adjustment + Fertile_age_15_to_30 * Net_Migration_Fraction)$

UNITS: person/yr

OUTFLOWS:

$Becoming_Age_30_plus = Fertile_age_15_to_30 / First_fertile_period$

UNITS: person/yr

$Fertile_Age_population(t) = Fertile_Age_population(t - dt) + (Becaming_Fertile_age - Fertile_Age_Population_Death_Rate - Fertile_Age_net_Migration - Becoming_Elderly) * dt$

INIT Fertile_Age_population = 30445000

UNITS: people (person)

INFLOWS:

$Becaming_Fertile_age = School_Age_population / Schoole_age_duration$

UNITS: person/yr

OUTFLOWS:

$Fertile_Age_Population_Death_Rate = Fertile_Age_population * Fertile_age_death_fraction_Adjustment$

UNITS: person/yr

$Fertile_Age_net_Migration = Fertile_Age_population * Net_Migration_Fraction$

UNITS: person/yr

$Becoming_Elderly = Fertile_Age_population / Fertile_Age_Duration$

UNITS: person/yr

$School_Age_population(t) = School_Age_population(t - dt) + (Becaming_Schoole_age - Becaming_Fertile_age - School_Age_Population_Death_Rate - School_Age_Net_Migration) * dt$

INIT School_Age_population = 15900000

UNITS: people (person)

INFLOWS:

$Becaming_Schoole_age = Child_population / Child_duration$

UNITS: person/yr

OUTFLOWS:

$$\text{Becaming_Fertile_age} = \text{School_Age_population} / \text{Schoole_age_duration}$$

UNITS: person/yr

$$\text{School_Age_Population_Death_Rate} = \text{School_Age_population} * \text{School_age_death_fraction_adjustment}$$

UNITS: person/yr

$$\text{School_Age_Net_Migration} = \text{School_Age_population} * \text{Net_Migration_Fraction}$$

UNITS: person/yr

$$\text{Average_Adult_Equivalent_calorie_For_15to_30} = 0.96$$

UNITS: Unitless

$$\text{Average_Adult_Equivalent_calorie_For_30_plus} = 0.91$$

UNITS: Unitless

$$\text{Average_Adult_Equivalent_calorie_For_child} = 0.48$$

UNITS: Unitless

$$\text{Average_Adult_Equivalent_calorie_For_School_age} = 0.8075$$

UNITS: Unitless

$$\begin{aligned} \text{Average_life_expectancy} = & \text{HistoricalAverage_Life_Expectancy} * (1 - \\ & \text{Percentage_contribution_of_undernourishment_on_life_expectancy}) + \text{HistoricalAverage_Life_Expectancy} * \text{Percentage_Contribution_of_undernourishment_on_life_expectancy} * (1 + (1 - \\ & \text{Relative_Prevalence_of_Undernourishment})) \end{aligned}$$

UNITS: year

$$\text{Change_in_Population} = \text{Total_Population} - \text{previous_year_population}$$

UNITS: people (person)

$$\text{Child_duration} = 5$$

UNITS: year

$$\begin{aligned} \text{Chiled_death_fraction_Adjustment} = & \text{chiled_death_fraction} * 0 + 1 * (\text{chiled_death_fraction} * (1 - \\ & \text{Percentage_Contribution_of_under_nourishment_on_dearh_fraction}) + \text{chiled_death_fraction} * \text{Percentage_Contribution_of_under_nourishment_on_dearh_fraction} * \text{Relative_Prevalence_of_Undernourishment}) \end{aligned}$$

$$\text{chiled_death_fraction} = \text{GRAPH}(\text{Average_life_expectancy})$$

(0.00, 1.00), (2.22, 0.976), (4.44, 0.891), (6.67, 0.833), (8.89, 0.745), (11.1, 0.531), (13.3, 0.48), (15.6, 0.435), (17.8, 0.269), (20.0, 0.127), (22.2, 0.114), (24.4, 0.103), (26.7, 0.0954), (28.9, 0.0866), (31.1, 0.0784), (33.3, 0.0722), (35.6, 0.0664), (37.8, 0.059), (40.0, 0.054), (42.2, 0.049), (44.4, 0.045), (46.7, 0.044), (48.9, 0.043), (51.1, 0.042), (53.3, 0.041), (55.6, 0.04), (57.8, 0.0379), (60.0, 0.033), (62.2, 0.025), (64.4, 0.017), (66.7, 0.0104), (68.9, 0.008), (71.1, 0.0058), (73.3, 0.0037), (75.6, 0.004), (77.8, 0.004), (80.0, 0.004)

UNITS: per year (1/yr)

$Comulative_Adult_Equivalent_Fraction_of_total_population =$
 $Average_Adult_Equivalent_calorie_For_15to_30*Share_of_15_to_30_population+Average_Adult_Equivalent_calorie_For_School_age*Share_of_School_age_Population+Average_Adult_Equivalent_calorie_For_30_plus*Share_pf_30_plus_and_elderly+Average_Adult_Equivalent_calorie_For_child*Share_of_Chiled_population$

UNITS: Unitless

$Elderly_death_fraction_Adjustment = GRAPH(Average_life_expectancy)$

(0.00, 1.00), (2.22, 0.969), (4.44, 0.942), (6.67, 0.867), (8.89, 0.813), (11.1, 0.721), (13.3, 0.643), (15.6, 0.571), (17.8, 0.517), (20.0, 0.41), (22.2, 0.389), (24.4, 0.37), (26.7, 0.353), (28.9, 0.337), (31.1, 0.322), (33.3, 0.309), (35.6, 0.296), (37.8, 0.285), (40.0, 0.274), (42.2, 0.276), (44.4, 0.267), (46.7, 0.259), (48.9, 0.257), (51.1, 0.252), (53.3, 0.244), (55.6, 0.236), (57.8, 0.228), (60.0, 0.221), (62.2, 0.219), (64.4, 0.198), (66.7, 0.166), (68.9, 0.154), (71.1, 0.14), (73.3, 0.12), (75.6, 0.12), (77.8, 0.12), (80.0, 0.12)

UNITS: per year (1/yr)

$Female_fertile_population = Fertile_Age_population*Femal_fertile_Fraction$

UNITS: people (person)

$Femal_fertile_Fraction = 0.52$

UNITS: Unitless

$fertile_age_death_fraction = GRAPH(Average_life_expectancy)$

(0.00, 0.99), (2.22, 0.949), (4.44, 0.898), (6.67, 0.84), (8.89, 0.806), (11.1, 0.667), (13.3, 0.585), (15.6, 0.49), (17.8, 0.316), (20.0, 0.135), (22.2, 0.0122), (24.4, 0.0111), (26.7, 0.01), (28.9, 0.009), (31.1, 0.008), (33.3, 0.007), (35.6, 0.006), (37.8, 0.006), (40.0, 0.005), (42.2, 0.0049), (44.4, 0.0043), (46.7, 0.0037), (48.9, 0.0032), (51.1, 0.0029), (53.3, 0.0027), (55.6, 0.0019), (57.8, 0.00154), (60.0, 0.00117), (62.2, 0.0008), (64.4, 0.0006), (66.7, 0.001), (68.9, 0.001), (71.1, 0.001), (73.3, 0.001), (75.6, 0.001), (77.8, 0.001), (80.0, 0.001)

UNITS: per year (1/yr)

$Fertile_age_death_fraction_Adjustment = fertile_age_death_fraction*0+1*(fertile_age_death_fraction*(1-Percentage_Contribution_of_under_nourishment_on_dearh_fraction)+fertile_age_death_fraction*Percentage_Contribution_of_under_nourishment_on_dearh_fraction*Relative_Prevalence_of_Undernourishment)$

$Fertile_Age_Duration = 35$

UNITS: year

$fertile_period = 35$

UNITS: year

$First_fertile_period = 15$

$Forcasted_Total_Fertility = GRAPH(TIME)$

(2010, 4.29), (2015, 3.90), (2020, 3.50), (2025, 3.10)

UNITS: Unitless

HistoricalAverage_Life_Expectancy = GRAPH(TIME)

(1995, 49.6), (1996, 50.3), (1997, 50.6), (1998, 51.4), (1999, 51.7), (2000, 52.3), (2001, 52.9), (2002, 53.7), (2003, 54.4), (2004, 55.2), (2005, 56.0), (2006, 56.7), (2007, 57.5), (2008, 58.1), (2009, 58.7), (2010, 59.2)

UNITS: year

Historical_population = GRAPH(TIME)

(1995, 5.7e+007), (1996, 5.9e+007), (1997, 6e+007), (1998, 6.2e+007), (1999, 6.4e+007), (2000, 6.6e+007), (2001, 6.7e+007), (2002, 6.9e+007), (2003, 7.1e+007), (2004, 7.3e+007), (2005, 7.4e+007), (2006, 7.6e+007), (2007, 7.8e+007), (2008, 7.9e+007), (2009, 8.1e+007), (2010, 8.3e+007)

UNITS: people (person)

Net_Migration__Fraction = 0.001

UNITS: per year (1/yr)

Percentage_contribution_of_undernourishment_on_life_expectancy = 0.08

UNITS: Unitless

Percentage_Contribution_of_under_nourishment_on_dearh_fraction = 0.078

UNITS: Unitless

population__growth_rate = Change_in__Population/previous_year_population

UNITS: Unitless

previous_year_population = SMTH1(Total__Population,1)

UNITS: people (person)

schoole_age_death_fraction = GRAPH(Average_life_expectancy)

(0.00, 1.00), (2.22, 0.871), (4.44, 0.789), (6.67, 0.718), (8.89, 0.667), (11.1, 0.575), (13.3, 0.449), (15.6, 0.391), (17.8, 0.323), (20.0, 0.128), (22.2, 0.0116), (24.4, 0.01), (26.7, 0.009), (28.9, 0.008), (31.1, 0.0077), (33.3, 0.0069), (35.6, 0.0062), (37.8, 0.0056), (40.0, 0.0047), (42.2, 0.0043), (44.4, 0.0037), (46.7, 0.0032), (48.9, 0.0027), (51.1, 0.0025), (53.3, 0.0019), (55.6, 0.0018), (57.8, 0.00157), (60.0, 0.00075), (62.2, 0.000508), (64.4, 0.001), (66.7, 0.001), (68.9, 0.001), (71.1, 0.001), (73.3, 0.001), (75.6, 0.001), (77.8, 0.001), (80.0, 0.001)

UNITS: per year (1/yr)

Schoole_age__duration = 10

UNITS: year

*School_age__death_fraction_adjustment = schoole_age_death_fraction*0+1*(schoole_age_death_fraction*(1-Percentage_Contribution_of_under_nourishment_on_dearh_fraction)+schoole_age_death_fraction*Percentage_Contribution_of_under_nourishment_on_dearh_fraction*.Relative_Prevalence_of_Undernourshment)*

Share_of_15_to_30_population = Fertile_age_15_to_30/Total__Population

UNITS: Unitless

Share_of_Chiled__population = Child__population/Total__Population

UNITS: Unitless

$$\text{Share_of_School_age_Population} = \text{School_Age_population} / \text{Total_Population}$$

UNITS: Unitless

$$\text{Share_pf_30_plus_and_elderly} = (\text{Fertile_Age_population} - \text{Fertile_age_15_to_30} + \text{Elderly_population}) / \text{Total_Population}$$

UNITS: Unitless

$$\text{Total_fertility_rate} = \text{GRAPH}(\text{TIME})$$

(1995, 6.91), (1996, 6.79), (1997, 6.66), (1998, 6.51), (1999, 6.35), (2000, 6.18), (2001, 5.99), (2002, 5.80), (2003, 5.60), (2004, 5.39), (2005, 5.19), (2006, 4.99), (2007, 4.80), (2008, 4.62), (2009, 4.45), (2010, 4.29), (2011, 4.14)

UNITS: Unitless

$$\text{Total_Population} = \text{Elderly_population} + \text{Fertile_Age_population} + \text{Child_population} + \text{School_Age_population}$$

UNITS: people (person)

Yield Sector:

$$\text{Adapted_Cultivation_Area[Fertilizer]}(t) = \text{Adapted_Cultivation_Area[Fertilizer]}(t - dt) + (\text{Input_adaptation_Rate[Agricultural_Inputs]} - \text{Degraded_Land[Agricultural_Inputs]}) * dt$$

$$\text{INIT Adapted_Cultivation_Area[Fertilizer]} = 2166.94$$

UNITS: hectare

$$\text{Adapted_Cultivation_Area[Improved_Seed]}(t) = \text{Adapted_Cultivation_Area[Improved_Seed]}(t - dt) + (\text{Input_adaptation_Rate[Agricultural_Inputs]} - \text{Degraded_Land[Agricultural_Inputs]}) * dt$$

$$\text{INIT Adapted_Cultivation_Area[Improved_Seed]} = 140.69$$

UNITS: hectare

INFLOWS:

$$\text{Input_adaptation_Rate[Fertilizer]} = \text{MIN}(\text{Additional_Adaption_Cultivation_Area[Fertilizer]}, \text{Cultivation_Area_Adjustment[Fertilizer]})$$

UNITS: hectares/yr

$$\text{Input_adaptation_Rate[Improved_Seed]} = \text{MIN}(\text{Additional_Adaption_Cultivation_Area[Improved_Seed]}, \text{Cultivation_Area_Adjustment[Improved_Seed]})$$

UNITS: hectares/yr

OUTFLOWS:

$$\text{Degraded_Land[Fertilizer]} = \text{Degradation_Rate}$$

UNITS: hectares/yr

Degraded_Land[Improved_Seed] = .Degradation_Rate

UNITS: hectares/yr

*Capacity__on_order[Fertilizer](t) = Capacity__on_order[Fertilizer](t - dt) +
(Capacity__Ordering[Agricultural_Inputs] - Capacity__Auquisition[Agricultural_Inputs]) * dt*

INIT Capacity__on_order[Fertilizer] = 2000

*Capacity__on_order[Improved_Seed](t) = Capacity__on_order[Improved_Seed](t - dt) +
(Capacity__Ordering[Agricultural_Inputs] - Capacity__Auquisition[Agricultural_Inputs]) * dt*

INIT Capacity__on_order[Improved_Seed] = 200

INFLOWS:

*Capacity__Ordering[Agricultural_Inputs] = (1-
Policy2_Activated)*0+Policy2_Activated*(SMTH1(Capacity__Deperciation,1)+Input__Capacity_Gap/InputCa
pacity__Adjustment_Time)*

OUTFLOWS:

*Capacity__Auquisition[Agricultural_Inputs] = (1-
Policy2_Activated)*0+Policy2_Activated*Capacity__on_order/Capacity__Acquisition_Time*

*Functioning_cupacity[Fertilizer](t) = Functioning_cupacity[Fertilizer](t - dt) +
(Capacity__Auquisition[Agricultural_Inputs] - Capacity__Deperciation[Agricultural_Inputs]) * dt*

INIT Functioning_cupacity[Fertilizer] = 5000

*Functioning_cupacity[Improved_Seed](t) = Functioning_cupacity[Improved_Seed](t - dt) +
(Capacity__Auquisition[Agricultural_Inputs] - Capacity__Deperciation[Agricultural_Inputs]) * dt*

INIT Functioning_cupacity[Improved_Seed] = 300

INFLOWS:

*Capacity__Auquisition[Agricultural_Inputs] = (1-
Policy2_Activated)*0+Policy2_Activated*Capacity__on_order/Capacity__Acquisition_Time*

OUTFLOWS:

*Capacity__Deperciation[Agricultural_Inputs] = (1-
Policy2_Activated)*0+Policy2_Activated*Functioning_cupacity/Capacity__Depreciation_Time*

*Non_Adapted_Cultivation_area[Fertilizer](t) = Non_Adapted_Cultivation_area[Fertilizer](t - dt) +
(New_Potential_Land[Agricultural_Inputs] - Input_adaptation__Rate[Agricultural_Inputs] -
Following[Agricultural_Inputs]) * dt*

INIT Non_Adapted_Cultivation_area[Fertilizer] = 4385.63

UNITS: hectare

*Non_Adapted_Cultivation_area[Improved_Seed](t) = Non_Adapted_Cultivation_area[Improved_Seed](t - dt) +
(New_Potential_Land[Agricultural_Inputs] - Input_adaptation__Rate[Agricultural_Inputs] -
Following[Agricultural_Inputs]) * dt*

INIT Non_Adapted_Cultivation_area[Improved_Seed] = 6552.86

UNITS: hectare

INFLOWS:

$New_Potential_Land[Fertilizer] = .Conversion_Rate_of_Arable_to_cultivation$

UNITS: hectares/yr

$New_Potential_Land[Improved_Seed] = .Conversion_Rate_of_Arable_to_cultivation$

UNITS: hectares/yr

OUTFLOWS:

$Input_adaptation_Rate[Fertilizer] =$
 $MIN(Additional_Adaption_Cultivation_Area[Fertilizer], Cultivation_Area_Adjustment[Fertilizer])$

UNITS: hectares/yr

$Input_adaptation_Rate[Improved_Seed] =$
 $MIN(Additional_Adaption_Cultivation_Area[Improved_Seed], Cultivation_Area_Adjustment[Improved_Seed])$

UNITS: hectares/yr

$Fallowing[Fertilizer] = .Net_Fallwing_Land$

UNITS: hectares/yr

$Fallowing[Improved_Seed] = .Net_Fallwing_Land$

UNITS: hectares/yr

$Producer_Price_per_000_Quin[Tef](t) = Producer_Price_per_000_Quin[Tef](t - dt)$

INIT $Producer_Price_per_000_Quin[Tef] = 200000$

$Producer_Price_per_000_Quin[Wheat](t) = Producer_Price_per_000_Quin[Wheat](t - dt)$

INIT $Producer_Price_per_000_Quin[Wheat] = 156000$

$Producer_Price_per_000_Quin[Maize](t) = Producer_Price_per_000_Quin[Maize](t - dt)$

INIT $Producer_Price_per_000_Quin[Maize] = 95000$

$Producer_Price_per_000_Quin[Barely](t) = Producer_Price_per_000_Quin[Barely](t - dt)$

INIT $Producer_Price_per_000_Quin[Barely] = 134000$

$Producer_Price_per_000_Quin[Rice](t) = Producer_Price_per_000_Quin[Rice](t - dt)$

INIT $Producer_Price_per_000_Quin[Rice] = 410220$

$Producer_Price_per_000_Quin[Sorghum](t) = Producer_Price_per_000_Quin[Sorghum](t - dt)$

INIT $Producer_Price_per_000_Quin[Sorghum] = 119000$

$Producer_Price_per_000_Quin[Millet](t) = Producer_Price_per_000_Quin[Millet](t - dt)$

INIT $Producer_Price_per_000_Quin[Millet] = 133000$

$Producer_Price_per_000_Quin[Oats](t) = Producer_Price_per_000_Quin[Oats](t - dt)$

$INIT\ Producer_Price_per_000_Quin[Oats] = 137000$

$Additional_Birr_gained_both_inputs(t) = Additional_Birr_gained_both_inputs(t - dt) + (Add_Rev_Both_in - Add_Reve_Both_out) * dt$

$INIT\ Additional_Birr_gained_both_inputs = 1$

$TRANSIT\ TIME = 1$

$CAPACITY = INF$

$INFLOW\ LIMIT = INF$

INFLOWS:

$Add_Rev_Both_in = Additional_Revenue_per_additional_both_input_used$

OUTFLOWS:

$Add_Reve_Both_out = CONVEYOR\ OUTFLOW$

$Additional_Birr_gained_with_additional_use_of_Fertilizer(t) = Additional_Birr_gained_with_additional_use_of_Fertilizer(t - dt) + (Add_Reve_Fert_in - Add_Reve_Fert_out) * dt$

$INIT\ Additional_Birr_gained_with_additional_use_of_Fertilizer = 1$

$TRANSIT\ TIME = 1$

$CAPACITY = INF$

$INFLOW\ LIMIT = INF$

INFLOWS:

$Add_Reve_Fert_in = Additional_revenue_per_additional_fertilizer_used$

OUTFLOWS:

$Add_Reve_Fert_out = CONVEYOR\ OUTFLOW$

$Additional_Cost_for_fertilizer_use(t) = Additional_Cost_for_fertilizer_use(t - dt) + (Add_cost_in - Add_cost_out) * dt$

$INIT\ Additional_Cost_for_fertilizer_use = 1$

$TRANSIT\ TIME = 1$

$CAPACITY = INF$

$INFLOW\ LIMIT = INF$

INFLOWS:

$Add_cost_in = Additional_cost_pet_additional_fertilizer$

OUTFLOWS:

Add_cost_out = CONVEYOR OUTFLOW

*Birr_gained_from_the_use_of_Fertilizer(t) = Birr_gained_from_the_use_of_Fertilizer(t - dt) + (Revenue_for__use_of_Fertilizer - Revenue_used_out) * dt*

INIT Birr_gained_from_the_use_of_Fertilizer = 4000

TRANSIT TIME = 1

CAPACITY = INF

INFLOW LIMIT = INF

INFLOWS:

Revenue_for__use_of_Fertilizer = Additional_Revenue_for_the_use_of_Fertilizer

OUTFLOWS:

Revenue_used_out = CONVEYOR OUTFLOW

*Cost_of_Fertilizer_used(t) = Cost_of_Fertilizer_used(t - dt) + (Cost_of_fertilizer - Cost_out) * dt*

INIT Cost_of_Fertilizer_used = 300

TRANSIT TIME = 1

CAPACITY = INF

INFLOW LIMIT = INF

INFLOWS:

Cost_of_fertilizer = Cost_of_fertilizer_use_per_hecror

OUTFLOWS:

Cost_out = CONVEYOR OUTFLOW

Additional_Adaption_Cultivation_Area[Fertilizer] =

*Non_Adapted_Cultivation_area[Fertilizer]*Intial_Input__using_Fraction[Fertilizer]*Attractiveness_of_using_fertilizer*

Additional_Adaption_Cultivation_Area[Improved_Seed] =

*Non_Adapted_Cultivation_area[Improved_Seed]*Intial_Input__using_Fraction[Improved_Seed]*Attractiveness_of_using_fertilizer*

*Additional_cost_pet_additional__fertilizer = Change_in__Fertilizer_use*Retailer_Dap_price_Birr_pe_Quintal*

Additional_Revenue_for_the_use_of_Fertilizer =

*(Change_in_Yield__with_the_use_of_Fertilizer[Tef]*Producer_Price__per_000_Quin[Tef]+Change_in_Yield__with_the_use_of_Fertilizer[Wheat]*Producer_Price__per_000_Quin[Wheat]+Change_in_Yield__with_the_use_of_Fertilizer[Maize]*Producer_Price__per_000_Quin[Maize]+Change_in_Yield__with_the_use_of_Fertilizer[Barely]*Producer_Price__per_000_Quin[Barely]+Change_in_Yield__with_the_use_of_Fertilizer[Rice]*Producer_Price__per_000_Quin[Rice]+Change_in_Yield__with_the_use_of_Fertilizer[Sorghum]*Producer_Price__per_000_Quin[Sorghum]+Change_in_Yield__with_the_use_of_Fertilizer[Millet]*Producer_Price__per_000_Quin[Millet]+Change_in_Yield__with_the_use_of_Fertilizer[Oats]*Producer_Price__per_000_Quin[Oats])/Unit_Adjustment__thousand*

$$\text{Additional_Revenue_per_additional_both_input_used} =$$

$$(\text{Change_in_yield_both_inputs}[\text{Tef}] * \text{Producer_Price_per_000_Quin}[\text{Tef}] + \text{Change_in_yield_both_inputs}[\text{Wheat}] * \text{Producer_Price_per_000_Quin}[\text{Wheat}] + \text{Change_in_yield_both_inputs}[\text{Maize}] * \text{Producer_Price_per_000_Quin}[\text{Maize}] + \text{Change_in_yield_both_inputs}[\text{Barely}] * \text{Producer_Price_per_000_Quin}[\text{Barely}] + \text{Change_in_yield_both_inputs}[\text{Rice}] * \text{Producer_Price_per_000_Quin}[\text{Rice}] + \text{Change_in_yield_both_inputs}[\text{Sorghum}] * \text{Producer_Price_per_000_Quin}[\text{Sorghum}] + \text{Change_in_yield_both_inputs}[\text{Millet}] * \text{Producer_Price_per_000_Quin}[\text{Millet}] + \text{Change_in_yield_both_inputs}[\text{Oats}] * \text{Producer_Price_per_000_Quin}[\text{Oats}]) / \text{Unit_Adjustment_thousand}$$

$$\text{Additional_revenue_per_additional_fertilizer_used} =$$

$$(\text{Change_in_yeild_with_additional_fertilizer_use}[\text{Tef}] * \text{Producer_Price_per_000_Quin}[\text{Tef}] + \text{Change_in_yeild_with_additional_fertilizer_use}[\text{Wheat}] * \text{Producer_Price_per_000_Quin}[\text{Wheat}] + \text{Change_in_yeild_with_additional_fertilizer_use}[\text{Maize}] * \text{Producer_Price_per_000_Quin}[\text{Maize}] + \text{Change_in_yeild_with_additional_fertilizer_use}[\text{Barely}] * \text{Producer_Price_per_000_Quin}[\text{Barely}] + \text{Change_in_yeild_with_additional_fertilizer_use}[\text{Rice}] * \text{Producer_Price_per_000_Quin}[\text{Rice}] + \text{Change_in_yeild_with_additional_fertilizer_use}[\text{Sorghum}] * \text{Producer_Price_per_000_Quin}[\text{Sorghum}] + \text{Change_in_yeild_with_additional_fertilizer_use}[\text{Millet}] * \text{Producer_Price_per_000_Quin}[\text{Millet}] + \text{Change_in_yeild_with_additional_fertilizer_use}[\text{Oats}] * \text{Producer_Price_per_000_Quin}[\text{Oats}]) / \text{Unit_Adjustment_thousand}$$

$$\text{Attractiveness_of_using_fertilizer} = \text{Birr_gained_from_the_use_of_Fertilizer} / \text{Cost_of_Fertilizer_used}$$

$$\text{Attractiveness_osf_using_Additional_fertilizer} =$$

$$\text{Additional_Birr_gained_with_additional_use_of_Fertilizer} / \text{Additional_Cost_for_fertilizer_use}$$

$$\text{Attractiveness_of_both_inputs_Using_Additional_Fertiizer} =$$

$$\text{Additional_Birr_gained_both_inputs} / \text{Additional_Cost_for_fertilizer_use}$$

$$\text{Availbe_Input}[\text{Fertilizer}] = (1 - \text{Policy2_Activated}) * \text{MIN}(\text{Input_Supply}[\text{Fertilizer}], \text{Desired_purchased_input}[\text{Fertilizer}]) + \text{Policy2_Activated} * \text{Input_Supply}[\text{Fertilizer}]$$

$$\text{Availbe_Input}[\text{Improved_Seed}] = (1 - \text{Policy2_Activated}) * \text{MIN}(\text{Input_Supply}[\text{Improved_Seed}], \text{Desired_purchased_input}[\text{Improved_Seed}]) + \text{Policy2_Activated} * \text{Input_Supply}[\text{Improved_Seed}]$$

$$\text{AverageMeher_rainfall_distribution} = \text{GRAPH}(\text{TIME})$$

(1995, 182), (1996, 173), (1997, 146), (1998, 190), (1999, 173), (2000, 175), (2001, 176), (2002, 148), (2003, 173), (2004, 176), (2005, 178), (2006, 171), (2007, 178), (2008, 177)

UNITS: millimeters (mm)

$$\text{Average_Amount_of_Imputs_Quintals_per_Ha}[\text{Fertilizer}] = \text{fertiliser_used_In_Quintalsper_Ha}$$

UNITS: quintal/hectare

$$\text{Average_Amount_of_Imputs_Quintals_per_Ha}[\text{Improved_Seed}] = 0.6$$

UNITS: quintal/hectare

$$\text{Average_Yield} =$$

$$(\text{Current_Yield}[\text{Tef}] + \text{Current_Yield}[\text{Wheat}] + \text{Current_Yield}[\text{Maize}] + \text{Current_Yield}[\text{Barely}] + \text{Current_Yield}[\text{Rice}] + \text{Current_Yield}[\text{Sorghum}] + \text{Current_Yield}[\text{Millet}] + \text{Current_Yield}[\text{Oats}]) / 8$$

UNITS: quintal/year-hectare

Barely__Fertilizer_Share = GRAPH(TIME)

(1995, 0.1), (2000, 0.1), (2005, 0.1), (2010, 0.118)

Barely__Seed = GRAPH(TIME)

(1995, 2438), (1996, 2362), (1997, 2362), (1998, 2324), (1999, 2438), (2000, 2400), (2001, 2362), (2002, 2362), (2003, 4534), (2004, 4578), (2005, 10023), (2006, 11943), (2007, 13632), (2008, 21956), (2009, 25175), (2010, 25835)

Barley_Yield = GRAPH(TIME)

(1995, 10.6), (1996, 10.6), (1997, 11.5), (1998, 9.26), (1999, 9.34), (2000, 10.8), (2001, 12.1), (2002, 8.75), (2003, 11.7), (2004, 12.1), (2005, 12.7), (2006, 13.3), (2007, 13.8), (2008, 15.5), (2009, 15.5), (2010, 16.3)

Capacity__Acquisition_Time[Fertilizer] = 1

Capacity__Acquisition_Time[Improved_Seed] = 5

Capacity__Depreciation_Time = 10

Cereal_Fertilizer_Input_share[Tef] = Tef__Fertilizer_Share

Cereal_Fertilizer_Input_share[Wheat] = 0.185

Cereal_Fertilizer_Input_share[Maize] = 0.225

Cereal_Fertilizer_Input_share[Barely] = Barely__Fertilizer_Share

Cereal_Fertilizer_Input_share[Rice] = 0.0001

Cereal_Fertilizer_Input_share[Sorghum] = Sorghum__Fertilizer_Share

Cereal_Fertilizer_Input_share[Millet] = 0.05

Cereal_Fertilizer_Input_share[Oats] = 0.0002

Cereal_Improved__Seed_Sale[Tef] = Seed_Production__Share_of_Tef

Cereal_Improved__Seed_Sale[Wheat] = Seed_Production__Share_of_Wheat

Cereal_Improved__Seed_Sale[Maize] = Seed_Production__Share_ofMaize

Cereal_Improved__Seed_Sale[Barely] = Seed_Production__Share_of_Barley

Cereal_Improved__Seed_Sale[Rice] = Seed_Production__Share_of_Rice

Cereal_Improved__Seed_Sale[Sorghum] = Seed_Production__Share_of_Sorghum

Cereal_Improved__Seed_Sale[Millet] = Seed_Production__Share_ofMillet

Cereal_Improved__Seed_Sale[Oats] = Seed_Production__Share_of_Oats

Cereal__Cultivated_Hectars[Tef] =

.Cereal_Cultivated__Area_in_thousand_Ha.Cultivation_Area_share_of_cereals[Tef]*

UNITS: hectare

*Cereal__Cultivated_Hectars[Wheat] =
.Cereal_Cultivated__Area_in_thousand_Ha*.Cultivation_Area_share_of_cereals[Wheat]*

UNITS: hectare

*Cereal__Cultivated_Hectars[Maize] =
.Cereal_Cultivated__Area_in_thousand_Ha*.Cultivation_Area_share_of_cereals[Maize]*

UNITS: hectare

*Cereal__Cultivated_Hectars[Barely] =
.Cereal_Cultivated__Area_in_thousand_Ha*.Cultivation_Area_share_of_cereals[Barely]*

UNITS: hectare

*Cereal__Cultivated_Hectars[Rice] =
.Cereal_Cultivated__Area_in_thousand_Ha*.Cultivation_Area_share_of_cereals[Rice]*

UNITS: hectare

*Cereal__Cultivated_Hectars[Sorghum] =
.Cereal_Cultivated__Area_in_thousand_Ha*.Cultivation_Area_share_of_cereals[Sorghum]*

UNITS: hectare

*Cereal__Cultivated_Hectars[Millet] =
.Cereal_Cultivated__Area_in_thousand_Ha*.Cultivation_Area_share_of_cereals[Millet]*

UNITS: hectare

*Cereal__Cultivated_Hectars[Oats] =
.Cereal_Cultivated__Area_in_thousand_Ha*.Cultivation_Area_share_of_cereals[Oats]*

UNITS: hectare

Cereal__Input_Share[Tef, Fertilizer] = Cereal_Fertilizer_Input_share[Tef]

Cereal__Input_Share[Tef, Improved_Seed] = Improved_Seed__Share_Tef

Cereal__Input_Share[Wheat, Fertilizer] = Cereal_Fertilizer_Input_share[Wheat]

Cereal__Input_Share[Wheat, Improved_Seed] = Improved_Seed__Share_Wheat

Cereal__Input_Share[Maize, Fertilizer] = Cereal_Fertilizer_Input_share[Maize]

Cereal__Input_Share[Maize, Improved_Seed] = Improved_Seed__Share_Maize

Cereal__Input_Share[Barely, Fertilizer] = Cereal_Fertilizer_Input_share[Barely]

Cereal__Input_Share[Barely, Improved_Seed] = Improved_Seed__Share_barely

Cereal__Input_Share[Rice, Fertilizer] = Cereal_Fertilizer_Input_share[Rice]

Cereal__Input_Share[Rice, Improved_Seed] = Improved_Seed__Share_Rice

Cereal__Input_Share[Sorghum, Fertilizer] = Cereal_Fertilizer_Input_share[Sorghum]

Cereal__Input_Share[Sorghum, Improved_Seed] = Improved_Seed__Share_Sorghum

Cereal__Input_Share[Millet, Fertilizer] = Cereal_Fertilizer_Input_share[Millet]

Cereal__Input_Share[Millet, Improved_Seed] = Improved_Seed__Share_Millet

Cereal__Input_Share[Oats, Fertilizer] = Cereal_Fertilizer_Input_share[Oats]

Cereal__Input_Share[Oats, Improved_Seed] = Improved_Seed__Share_Oats

*Change_in_yeild__with_additional_fertilizer_use[Tef] = Yield_with__only_Fertilizer[Tef]-
Previous_yield_with_only_fertilizer[Tef]*

*Change_in_yeild__with_additional_fertilizer_use[Wheat] = Yield_with__only_Fertilizer[Wheat]-
Previous_yield_with_only_fertilizer[Wheat]*

*Change_in_yeild__with_additional_fertilizer_use[Maize] = Yield_with__only_Fertilizer[Maize]-
Previous_yield_with_only_fertilizer[Maize]*

*Change_in_yeild__with_additional_fertilizer_use[Barely] = Yield_with__only_Fertilizer[Barely]-
Previous_yield_with_only_fertilizer[Barely]*

*Change_in_yeild__with_additional_fertilizer_use[Rice] = Yield_with__only_Fertilizer[Rice]-
Previous_yield_with_only_fertilizer[Rice]*

*Change_in_yeild__with_additional_fertilizer_use[Sorghum] = Yield_with__only_Fertilizer[Sorghum]-
Previous_yield_with_only_fertilizer[Sorghum]*

*Change_in_yeild__with_additional_fertilizer_use[Millet] = Yield_with__only_Fertilizer[Millet]-
Previous_yield_with_only_fertilizer[Millet]*

*Change_in_yeild__with_additional_fertilizer_use[Oats] = Yield_with__only_Fertilizer[Oats]-
Previous_yield_with_only_fertilizer[Oats]*

Change_in_yield__both_inputs[Tef] = Yield_with__both_inputs[Tef]-Previous_year__yield_both_inputs[Tef]

*Change_in_yield__both_inputs[Wheat] = Yield_with__both_inputs[Wheat]-
Previous_year__yield_both_inputs[Wheat]*

*Change_in_yield__both_inputs[Maize] = Yield_with__both_inputs[Maize]-
Previous_year__yield_both_inputs[Maize]*

*Change_in_yield__both_inputs[Barely] = Yield_with__both_inputs[Barely]-
Previous_year__yield_both_inputs[Barely]*

*Change_in_yield__both_inputs[Rice] = Yield_with__both_inputs[Rice]-
Previous_year__yield_both_inputs[Rice]*

*Change_in_yield__both_inputs[Sorghum] = Yield_with__both_inputs[Sorghum]-
Previous_year__yield_both_inputs[Sorghum]*

*Change_in_yield__both_inputs[Millet] = Yield_with__both_inputs[Millet]-
Previous_year__yield_both_inputs[Millet]*

*Change_in_yield__both_inputs[Oats] = Yield_with__both_inputs[Oats]-
Previous_year__yield_both_inputs[Oats]*

*Change_in_Yield__with_the_use_of_Fertilizer[Tef] = Yield_with__only_Fertilizer[Tef]-
Yield_with__no_input[Tef]*

$Change_in_Yield_with_the_use_of_Fertilizer[Wheat] = Yield_with_only_Fertilizer[Wheat] - Yield_with_no_input[Wheat]$

$Change_in_Yield_with_the_use_of_Fertilizer[Maize] = Yield_with_only_Fertilizer[Maize] - Yield_with_no_input[Maize]$

$Change_in_Yield_with_the_use_of_Fertilizer[Barely] = Yield_with_only_Fertilizer[Barely] - Yield_with_no_input[Barely]$

$Change_in_Yield_with_the_use_of_Fertilizer[Rice] = Yield_with_only_Fertilizer[Rice] - Yield_with_no_input[Rice]$

$Change_in_Yield_with_the_use_of_Fertilizer[Sorghum] = Yield_with_only_Fertilizer[Sorghum] - Yield_with_no_input[Sorghum]$

$Change_in_Yield_with_the_use_of_Fertilizer[Millet] = Yield_with_only_Fertilizer[Millet] - Yield_with_no_input[Millet]$

$Change_in_Yield_with_the_use_of_Fertilizer[Oats] = Yield_with_only_Fertilizer[Oats] - Yield_with_no_input[Oats]$

$Change_in_Fertilizer_use = fertiliser_used_In_Quintalsper_Ha - Previous_year_fertilizer_used_in_quintals_per_Ha$

$Cost_of_fertilizer_use_per_hector = fertiliser_used_In_Quintalsper_Ha * Retailer_Dap_price_Birr_pe_Quintal$

$Cultivation_area_for_Input_cover_in_000_Ha = Percieved_Potential_Input_Covered_land * Unit_Adjustment_000$

$Cultivation_Area_Adjustment[Fertilizer] = Expected_Hectars_000_with_input_input[Fertilizer] - Adapted_Cultivation_Area[Fertilizer] / Input_Adjustment_Time$

$Cultivation_Area_Adjustment[Improved_Seed] = Expected_Hectars_000_with_input_input[Improved_Seed] - Adapted_Cultivation_Area[Improved_Seed] / Input_Adjustment_Time$

$Current_supply_Capacity[Fertilizer] = Functioning_cupacity[Fertilizer] * Unit_Production_Capacity[Fertilizer]$

$Current_supply_Capacity[Improved_Seed] = Functioning_cupacity[Improved_Seed] * Unit_Production_Capacity[Improved_Seed]$

$Current_Yield[Tef] = Yield_with_both_inputs[Tef] * Share_of_Cereal_Ha_both_Inputs[Tef] + Yield_with_only_Fertilizer[Tef] * Share_of_Cereal_Ha_only_Fertilizer[Tef] + Yield_with_no_input[Tef] * Share_of_Cereal_Ha_no_Inputs[Tef]$

UNITS: quintal/year-hectare

$Current_Yield[Wheat] = Yield_with_both_inputs[Wheat] * Share_of_Cereal_Ha_both_Inputs[Wheat] + Yield_with_only_Fertilizer[Wheat] * Share_of_Cereal_Ha_only_Fertilizer[Wheat] + Yield_with_no_input[Wheat] * Share_of_Cereal_Ha_no_Inputs[Wheat]$

UNITS: quintal/year-hectare

$Current_Yield[Maize] = Yield_with_both_inputs[Maize] * Share_of_Cereal_Ha_both_Inputs[Maize] + Yield_with_only_Fertilizer[Mai$

$ze] * Share_of_Cereal_Ha_only_Fertilizer[Maize] + Yield_with_no_input[Maize] * Share_of_Cereal_Ha_no_Inputs[Maize]$

UNITS: quintal/year-hectare

$Current_Yield[Barely] = Yield_with_both_inputs[Barely] * Share_of_Cereal_Ha_both_Inputs[Barely] + Yield_with_only_Fertilizer[Barely] * Share_of_Cereal_Ha_only_Fertilizer[Barely] + Yield_with_no_input[Barely] * Share_of_Cereal_Ha_no_Inputs[Barely]$

UNITS: quintal/year-hectare

$Current_Yield[Rice] = Rice_Yield$

UNITS: quintal/year-hectare

$Current_Yield[Sorghum] = Sorghum_Yield$

UNITS: quintal/year-hectare

$Current_Yield[Millet] = Yield_with_both_inputs[Millet] * Share_of_Cereal_Ha_both_Inputs[Millet] + Yield_with_only_Fertilizer[Millet] * Share_of_Cereal_Ha_only_Fertilizer[Millet] + Yield_with_no_input[Millet] * Share_of_Cereal_Ha_no_Inputs[Millet]$

UNITS: quintal/year-hectare

$Current_Yield[Oats] = Oats_Yield$

UNITS: quintal/year-hectare

$Desired_Capacity[Fertilizer] = Desired_Input_amount[Fertilizer] / Unit_Production_Capacity[Fertilizer]$

$Desired_Capacity[Improved_Seed] = Desired_Input_amount[Improved_Seed] / Unit_Production_Capacity[Improved_Seed]$

$Desired_Cultivation_Area = SMTH1(Desired_Production[Tef] / Current_Yield[Tef] + Desired_Production[Wheat] / Current_Yield[Wheat] + Desired_Production[Maize] / Current_Yield[Maize] + Desired_Production[Barely] / Current_Yield[Barely] + Desired_Production[Rice] / (1 + Current_Yield[Rice]) + Desired_Production[Sorghum] / Current_Yield[Sorghum] + Desired_Production[Millet] / Current_Yield[Millet] + Desired_Production[Oats] / Current_Yield[Oats], 3)$

UNITS: hectare

$Desired_Production[Tef] = .Desired_Cereal_Consumption[Tef] * (1 + Seed_and_loss_fraction)$

$Desired_Production[Wheat] = .Desired_Cereal_Consumption[Wheat] * (1 + Seed_and_loss_fraction)$

$Desired_Production[Maize] = .Desired_Cereal_Consumption[Maize] * (1 + Seed_and_loss_fraction)$

$Desired_Production[Barely] = .Desired_Cereal_Consumption[Barely] * (1 + Seed_and_loss_fraction)$

$Desired_Production[Rice] = .Desired_Cereal_Consumption[Rice] * (1 + Seed_and_loss_fraction)$

$Desired_Production[Sorghum] = .Desired_Cereal_Consumption[Sorghum] * (1 + Seed_and_loss_fraction)$

$Desired_Production[Millet] = .Desired_Cereal_Consumption[Millet] * (1 + Seed_and_loss_fraction)$

$Desired_Production[Oats] = .Desired_Cereal_Consumption[Oats]*(1+Seed_and_loss_fraction)$

$Desired_Input_amount[Fertilizer] =$
 $Cultivation_area_for_Input_cover_in_000_Ha*Average_Amount_of_Inputs_Quintals_per_Ha[Fertilizer]$

$Desired_Input_amount[Improved_Seed] =$
 $Cultivation_area_for_Input_cover_in_000_Ha*Average_Amount_of_Inputs_Quintals_per_Ha[Improved_Seed]$

$Desired_purchased_input[Fertilizer] =$
 $.Budget_allcated_For_Input[Fertilizer]/Inputs_Price_per_Quintal[Fertilizer]$

UNITS: quintal/year

$Desired_purchased_input[Improved_Seed] =$
 $.Budget_allcated_For_Input[Improved_Seed]/Inputs_Price_per_Quintal[Improved_Seed]$

UNITS: quintal/year

$Effective_Input_Available[Fertilizer] =$
 $MIN(Desired_Input_amount[Fertilizer],Current_supply_Capacity[Fertilizer])$

$Effective_Input_Available[Improved_Seed] =$
 $MIN(Desired_Input_amount[Improved_Seed],Current_supply_Capacity[Improved_Seed])$

$Effect_of_rainfall_on_yield = GRAPH(AverageMeher_rainfall_distribution)$

(0.00, 0.00), (17.9, 0.00), (35.7, 0.00), (53.6, 0.01), (71.4, 0.05), (89.3, 0.17), (107, 0.36), (125, 0.6), (143, 0.91), (161, 0.97), (179, 1.09), (196, 0.97), (214, 0.65), (232, 0.14), (250, 0.00)

UNITS: Unitless

$Elasticity_of_yield_for_fertilizer[Tef] = 0.15$

UNITS: Unitless

$Elasticity_of_yield_for_fertilizer[Wheat] = 0.14$

UNITS: Unitless

$Elasticity_of_yield_for_fertilizer[Maize] = 0.16$

UNITS: Unitless

$Elasticity_of_yield_for_fertilizer[Barely] = 0.1$

UNITS: Unitless

$Elasticity_of_yield_for_fertilizer[Rice] = 0.11$

UNITS: Unitless

$Elasticity_of_yield_for_fertilizer[Sorghum] = 0.1$

UNITS: Unitless

$Elasticity_of_yield_for_fertilizer[Millet] = 0.1$

UNITS: Unitless

Elasticity_of_yield_for_fertilizer[Oats] = 0.1

UNITS: Unitless

Elasticity_of_Yield_for_improved_Seed_and_Fertilizer[Tef] = 0.2

UNITS: Unitless

Elasticity_of_Yield_for_improved_Seed_and_Fertilizer[Wheat] = 0.23

UNITS: Unitless

Elasticity_of_Yield_for_improved_Seed_and_Fertilizer[Maize] = 0.3

UNITS: Unitless

Elasticity_of_Yield_for_improved_Seed_and_Fertilizer[Barely] = 0.2

UNITS: Unitless

Elasticity_of_Yield_for_improved_Seed_and_Fertilizer[Rice] = 0.25

UNITS: Unitless

Elasticity_of_Yield_for_improved_Seed_and_Fertilizer[Sorghum] = 0.2

UNITS: Unitless

Elasticity_of_Yield_for_improved_Seed_and_Fertilizer[Millet] = 0.15

UNITS: Unitless

Elasticity_of_Yield_for_improved_Seed_and_Fertilizer[Oats] = 0

UNITS: Unitless

ESE_Annual__Seed_Sales_In_Quintals[Tef] = Tef__Seed

UNITS: quintal/year

ESE_Annual__Seed_Sales_In_Quintals[Wheat] = Wheat__Seed

UNITS: quintal/year

ESE_Annual__Seed_Sales_In_Quintals[Maize] = Maize__Seed

UNITS: quintal/year

ESE_Annual__Seed_Sales_In_Quintals[Barely] = Barely__Seed

UNITS: quintal/year

ESE_Annual__Seed_Sales_In_Quintals[Rice] = Rice__Seed

UNITS: quintal/year

ESE_Annual__Seed_Sales_In_Quintals[Sorghum] = Sorghum__Seed

UNITS: quintal/year

ESE_Annual__Seed_Sales_In_Quintals[Millet] = Millet__seed

UNITS: quintal/year

ESE_Annual__Seed_Sales_In_Quintals[Oats] = Oats__seed

UNITS: quintal/year

EsImproved_Seed__Price_Barely = GRAPH(TIME)

(1995, 244), (1996, 239), (1997, 249), (1998, 248), (1999, 271), (2000, 272), (2001, 223), (2002, 271), (2003, 291), (2004, 290), (2005, 336), (2006, 350), (2007, 423), (2008, 539), (2009, 488), (2010, 460)

UNITS: birr/quintal

EsImproved__Seed_Price_Tef = GRAPH(TIME)

(1995, 360), (1996, 334), (1997, 326), (1998, 324), (1999, 338), (2000, 353), (2001, 322), (2002, 324), (2003, 352), (2004, 378), (2005, 403), (2006, 470), (2007, 478), (2008, 573), (2009, 580), (2010, 540)

UNITS: birr/quintal

Estimated_Improved_seed_Price__Birr_per_Quintal =

(EsImproved__Seed_Price_Tef+Es_Improved__Seed__Price_Wheat+Es_Improved_Seed__Price_Maize+EsImproved_Seed__Price_Barely)/4

UNITS: birr/quintal

Estimated_Reginal_Production_of_improved_Seed[Tef] =

*Share_of_reginal_Improved_Seed_production*Tef__Seed*

UNITS: quintal/year

Estimated_Reginal_Production_of_improved_Seed[Wheat] =

*Share_of_reginal_Improved_Seed_production*Wheat__Seed*

UNITS: quintal/year

Estimated_Reginal_Production_of_improved_Seed[Maize] =

*Share_of_reginal_Improved_Seed_production*Maize__Seed*

UNITS: quintal/year

Estimated_Reginal_Production_of_improved_Seed[Barely] =

*Share_of_reginal_Improved_Seed_production*Barely__Seed*

UNITS: quintal/year

Estimated_Reginal_Production_of_improved_Seed[Rice] =

*Share_of_reginal_Improved_Seed_production*Rice__Seed*

UNITS: quintal/year

Estimated_Reginal_Production_of_improved_Seed[Sorghum] =

*Share_of_reginal_Improved_Seed_production*Sorghum__Seed*

UNITS: quintal/year

*Estimated_Regional_Production_of_improved_Seed[Millet] =
Share_of_regional_Improved_Seed_production*Millet__seed*

UNITS: quintal/year

*Estimated_Regional_Production_of_improved_Seed[Oats] =
Share_of_regional_Improved_Seed_production*Oats__seed*

UNITS: quintal/year

Es_Improved_Seed__Price_Maize = GRAPH(TIME)

(1995, 287), (1996, 349), (1997, 382), (1998, 547), (1999, 404), (2000, 403), (2001, 374), (2002, 250), (2003, 456), (2004, 426), (2005, 526), (2006, 504), (2007, 584), (2008, 632), (2009, 601), (2010, 638)

UNITS: birr/quintal

Es_Improved__Seed__Price_Wheat = GRAPH(TIME)

(1995, 219), (1996, 213), (1997, 245), (1998, 250), (1999, 262), (2000, 257), (2001, 222), (2002, 245), (2003, 260), (2004, 263), (2005, 297), (2006, 338), (2007, 399), (2008, 594), (2009, 573), (2010, 584)

UNITS: birr/quintal

*Expected_Hectars_000_with_input_input[Fertilizer] =
Availbe_Input[Fertilizer]/(Average_Amount_of__Imputs_Quintals_per_Ha[Fertilizer]*Thousand_Ha__Unit_A
djustment)*

*Expected_Hectars_000_with_input_input[Improved_Seed] =
Availbe_Input[Improved_Seed]/(Average_Amount_of__Imputs_Quintals_per_Ha[Improved_Seed]*Thousand_
Ha__Unit_Adjustment)*

fertiliser_used_In_Quintalsper_Ha = GRAPH(TIME)

(1995, 0.75), (2000, 0.7), (2005, 0.8), (2010, 0.9)

*Fertilizer__Availeble_for_cereal =
IF(TIME<2010)THEN(Historical_Total_Fertilizer_Consumption_in_Quntals*(1-
Share_of_Cereal_fertilizer_Availeblity))ELSE(Forcasted__total_fertilizer)*

UNITS: quintal/year

Forcasted__total_fertilizer = GRAPH(TIME)

(2010, 4.7e+006), (2015, 5.8e+006), (2020, 7e+006), (2025, 8.3e+006)

UNITS: quintal/year

*Hectars_Coverd__by_type_of_cereals[Tef, Fertilizer] = (1-
Policy2_Activated)*Adapted__Cultivation_Area[Fertilizer]*Cereal__Input_Share[Tef,
Fertilizer]+Policy2_Activated*Adapted__Cultivation_Area[Fertilizer]*Cereal__Input_Share[Tef, Fertilizer]*

UNITS: hectare

*Hectars_Coverd__by_type_of_cereals[Tef, Improved_Seed] = (1-
Policy2_Activated)*Adapted__Cultivation_Area[Improved_Seed]*Cereal__Input_Share[Tef,
Improved_Seed]+Policy2_Activated*Adapted__Cultivation_Area[Improved_Seed]*Cereal__Input_Share[Tef,
Improved_Seed]*

UNITS: hectare

$Hectars_Coverd_by_type_of_cereals[Wheat, Fertilizer] = (1 - Policy2_Activated) * Adapted_Cultivation_Area[Fertilizer] * Cereal_Input_Share[Wheat, Fertilizer] + Policy2_Activated * Adapted_Cultivation_Area[Fertilizer] * Cereal_Input_Share[Wheat, Fertilizer]$

UNITS: hectare

$Hectars_Coverd_by_type_of_cereals[Wheat, Improved_Seed] = (1 - Policy2_Activated) * Adapted_Cultivation_Area[Improved_Seed] * Cereal_Input_Share[Wheat, Improved_Seed] + Policy2_Activated * Adapted_Cultivation_Area[Improved_Seed] * Cereal_Input_Share[Wheat, Improved_Seed]$

UNITS: hectare

$Hectars_Coverd_by_type_of_cereals[Maize, Fertilizer] = (1 - Policy2_Activated) * Adapted_Cultivation_Area[Fertilizer] * Cereal_Input_Share[Maize, Fertilizer] + Policy2_Activated * Adapted_Cultivation_Area[Fertilizer] * Cereal_Input_Share[Maize, Fertilizer]$

UNITS: hectare

$Hectars_Coverd_by_type_of_cereals[Maize, Improved_Seed] = (1 - Policy2_Activated) * Adapted_Cultivation_Area[Improved_Seed] * Cereal_Input_Share[Maize, Improved_Seed] + Policy2_Activated * Adapted_Cultivation_Area[Improved_Seed] * Cereal_Input_Share[Maize, Improved_Seed]$

UNITS: hectare

$Hectars_Coverd_by_type_of_cereals[Barely, Fertilizer] = (1 - Policy2_Activated) * Adapted_Cultivation_Area[Fertilizer] * Cereal_Input_Share[Barely, Fertilizer] + Policy2_Activated * Adapted_Cultivation_Area[Fertilizer] * Cereal_Input_Share[Barely, Fertilizer]$

UNITS: hectare

$Hectars_Coverd_by_type_of_cereals[Barely, Improved_Seed] = (1 - Policy2_Activated) * Adapted_Cultivation_Area[Improved_Seed] * Cereal_Input_Share[Barely, Improved_Seed] + Policy2_Activated * Adapted_Cultivation_Area[Improved_Seed] * Cereal_Input_Share[Barely, Improved_Seed]$

UNITS: hectare

$Hectars_Coverd_by_type_of_cereals[Rice, Fertilizer] = (1 - Policy2_Activated) * Adapted_Cultivation_Area[Fertilizer] * Cereal_Input_Share[Rice, Fertilizer] + Policy2_Activated * Adapted_Cultivation_Area[Fertilizer] * Cereal_Input_Share[Rice, Fertilizer]$

UNITS: hectare

$Hectars_Coverd_by_type_of_cereals[Rice, Improved_Seed] = (1 - Policy2_Activated) * Adapted_Cultivation_Area[Improved_Seed] * Cereal_Input_Share[Rice, Improved_Seed] + Policy2_Activated * Adapted_Cultivation_Area[Improved_Seed] * Cereal_Input_Share[Rice, Improved_Seed]$

UNITS: hectare

$Hectars_Coverd_by_type_of_cereals[Sorghum, Fertilizer] = (1 - Policy2_Activated) * Adapted_Cultivation_Area[Fertilizer] * Cereal_Input_Share[Sorghum, Fertilizer] + Policy2_Activated * Adapted_Cultivation_Area[Fertilizer] * Cereal_Input_Share[Sorghum, Fertilizer]$

$Fertilizer] + Policy2_Activated * Adapted_Cultivation_Area[Fertilizer] * Cereal_Input_Share[Sorghum, Fertilizer]$

UNITS: hectare

$Hectars_Coverd_by_type_of_cereals[Sorghum, Improved_Seed] = (1 - Policy2_Activated) * Adapted_Cultivation_Area[Improved_Seed] + Policy2_Activated * Adapted_Cultivation_Area[Improved_Seed] * Cereal_Input_Share[Sorghum, Improved_Seed]$

UNITS: hectare

$Hectars_Coverd_by_type_of_cereals[Millet, Fertilizer] = (1 - Policy2_Activated) * Adapted_Cultivation_Area[Fertilizer] * Cereal_Input_Share[Millet, Fertilizer] + Policy2_Activated * Adapted_Cultivation_Area[Fertilizer] * Cereal_Input_Share[Millet, Fertilizer]$

UNITS: hectare

$Hectars_Coverd_by_type_of_cereals[Millet, Improved_Seed] = (1 - Policy2_Activated) * Adapted_Cultivation_Area[Improved_Seed] * Cereal_Input_Share[Millet, Improved_Seed] + Policy2_Activated * Adapted_Cultivation_Area[Improved_Seed] * Cereal_Input_Share[Millet, Improved_Seed]$

UNITS: hectare

$Hectars_Coverd_by_type_of_cereals[Oats, Fertilizer] = (1 - Policy2_Activated) * Adapted_Cultivation_Area[Fertilizer] * Cereal_Input_Share[Oats, Fertilizer] + Policy2_Activated * Adapted_Cultivation_Area[Fertilizer] * Cereal_Input_Share[Oats, Fertilizer]$

UNITS: hectare

$Hectars_Coverd_by_type_of_cereals[Oats, Improved_Seed] = (1 - Policy2_Activated) * Adapted_Cultivation_Area[Improved_Seed] * Cereal_Input_Share[Oats, Improved_Seed] + Policy2_Activated * Adapted_Cultivation_Area[Improved_Seed] * Cereal_Input_Share[Oats, Improved_Seed]$

UNITS: hectare

$Historical_Cereal_Yield[Tef] = Tef_Yield$

$Historical_Cereal_Yield[Wheat] = Wheat_Yield$

$Historical_Cereal_Yield[Maize] = Maize_yield$

$Historical_Cereal_Yield[Barely] = Barley_Yield$

$Historical_Cereal_Yield[Rice] = Rice_Yield$

$Historical_Cereal_Yield[Sorghum] = Sorghum_Yield$

$Historical_Cereal_Yield[Millet] = Millet_Yield$

$Historical_Cereal_Yield[Oats] = Oats_Yield$

$Historical_Meher_Area = GRAPH(TIME)$

(1995, 6653), (1996, 6689), (1997, 5602), (1998, 6745), (1999, 6747), (2000, 7637), (2001, 6370), (2002, 6324), (2003, 6999), (2004, 7638), (2005, 8081), (2006, 8472), (2007, 8730), (2008, 8770), (2009, 9233), (2010, 9691)

Historical_Total_Fertilizer_Consumption_in_Quintals = GRAPH(TIME)

(1995, 2.5e+006), (1996, 2.5e+006), (1997, 2.2e+006), (1998, 2.8e+006), (1999, 2.9e+006), (2000, 3e+006), (2001, 2.8e+006), (2002, 2.3e+006), (2003, 2.6e+006), (2004, 3.2e+006), (2005, 3.5e+006), (2006, 3.8e+006), (2007, 3.9e+006), (2008, 4e+006), (2009, 4.3e+006), (2010, 5e+006)

UNITS: quintal/year

Improved_seed_Price__Birr_per_Quintal[Tef] = Improved__Seed_Price_Tef

Improved_seed_Price__Birr_per_Quintal[Wheat] = Improved__Seed_Price_Wheat

Improved_seed_Price__Birr_per_Quintal[Maize] = Improved__Seed_Price_Maize

Improved_seed_Price__Birr_per_Quintal[Barely] = Improved__Seed_Price_Barely

Improved_seed_Price__Birr_per_Quintal[Rice] = Improved__Seed_Price_Rice

Improved_seed_Price__Birr_per_Quintal[Sorghum] = Improved__Seed_Price_Sorghum

Improved_seed_Price__Birr_per_Quintal[Millet] = Improved__Seed_Price_Millet

Improved_seed_Price__Birr_per_Quintal[Oats] = Improved__Seed_PriceOats

Improved_Seed__Share_barely = 0.075

Improved_Seed__Share_Maize = 0.3

Improved_Seed__Share_Oats = 0.001

Improved_Seed__Share_Rice = 0.001

Improved_Seed__Share_Sorghum = 0.02

Improved_Seed__Share_Tef = 0.25

Improved_Seed__Share_Wheat = 0.3

Improved_Seed__PriceOats = GRAPH(TIME)

(1995, 0.00), (1996, 0.00), (1997, 0.00), (1998, 0.00), (1999, 0.00), (2000, 0.00), (2001, 0.00), (2002, 0.00), (2003, 0.00), (2004, 0.00), (2005, 0.00), (2006, 0.00), (2007, 0.00), (2008, 0.00), (2009, 0.00), (2010, 0.00)

Improved_Seed__Price_Barely = GRAPH(TIME)

(1995, 244), (1996, 239), (1997, 249), (1998, 248), (1999, 271), (2000, 272), (2001, 223), (2002, 271), (2003, 0.00), (2004, 0.00), (2005, 0.00), (2006, 0.00), (2007, 0.00), (2008, 0.00), (2009, 0.00), (2010, 0.00)

Improved_Seed__Price_Maize = GRAPH(TIME)

(1995, 287), (1996, 349), (1997, 382), (1998, 547), (1999, 404), (2000, 403), (2001, 374), (2002, 250), (2003, 0.00), (2004, 0.00), (2005, 0.00), (2006, 0.00), (2007, 0.00), (2008, 0.00), (2009, 0.00), (2010, 0.00)

Improved_Seed__Price_Millet = GRAPH(TIME)

(1995, 0.00), (1996, 0.00), (1997, 0.00), (1998, 0.00), (1999, 0.00), (2000, 0.00), (2001, 0.00), (2002, 0.00), (2003, 0.00), (2004, 0.00), (2005, 0.00), (2006, 0.00), (2007, 0.00), (2008, 0.00), (2009, 0.00), (2010, 0.00)

Improved_Seed__Price_Rice = GRAPH(TIME)

(1995, 0.00), (1996, 0.00), (1997, 0.00), (1998, 0.00), (1999, 0.00), (2000, 0.00), (2001, 0.00), (2002, 0.00), (2003, 0.00), (2004, 0.00), (2005, 0.00), (2006, 0.00), (2007, 0.00), (2008, 0.00), (2009, 0.00), (2010, 0.00)

Improved_Seed__Price_Sorghum = GRAPH(TIME)

(1995, 0.00), (1996, 0.00), (1997, 0.00), (1998, 0.00), (1999, 0.00), (2000, 0.00), (2001, 0.00), (2002, 0.00), (2003, 0.00), (2004, 0.00), (2005, 0.00), (2006, 0.00), (2007, 0.00), (2008, 0.00), (2009, 0.00), (2010, 0.00)

Improved_Seed__Share_Millet = 0.025

Improved__Seed__Price_Wheat = GRAPH(TIME)

(1995, 219), (1996, 213), (1997, 245), (1998, 250), (1999, 262), (2000, 257), (2001, 222), (2002, 245), (2003, 0.00), (2004, 0.00), (2005, 0.00), (2006, 0.00), (2007, 0.00), (2008, 0.00), (2009, 0.00), (2010, 0.00)

Improved__Seed_Price_Tef = GRAPH(TIME)

(1995, 360), (1996, 334), (1997, 326), (1998, 324), (1999, 338), (2000, 353), (2001, 322), (2002, 324), (2003, 0.00), (2004, 0.00), (2005, 0.00), (2006, 0.00), (2007, 0.00), (2008, 0.00), (2009, 0.00), (2010, 0.00)

Improvrd_Cereal__Seeds_Availble[Tef] =

ESE_Annual__Seed_Sales_In_Quintals[Tef]+*Estimated_Reginal_Production_of_improved_Seed[Tef]*

UNITS: quintal/year

Improvrd_Cereal__Seeds_Availble[Wheat] =

ESE_Annual__Seed_Sales_In_Quintals[Wheat]+*Estimated_Reginal_Production_of_improved_Seed[Wheat]*

UNITS: quintal/year

Improvrd_Cereal__Seeds_Availble[Maize] =

ESE_Annual__Seed_Sales_In_Quintals[Maize]+*Estimated_Reginal_Production_of_improved_Seed[Maize]*

UNITS: quintal/year

Improvrd_Cereal__Seeds_Availble[Barely] =

ESE_Annual__Seed_Sales_In_Quintals[Barely]+*Estimated_Reginal_Production_of_improved_Seed[Barely]*

UNITS: quintal/year

Improvrd_Cereal__Seeds_Availble[Rice] =

ESE_Annual__Seed_Sales_In_Quintals[Rice]+*Estimated_Reginal_Production_of_improved_Seed[Rice]*

UNITS: quintal/year

Improvrd_Cereal__Seeds_Availble[Sorghum] =

ESE_Annual__Seed_Sales_In_Quintals[Sorghum]+*Estimated_Reginal_Production_of_improved_Seed[Sorghum]*

UNITS: quintal/year

Improvrd_Cereal__Seeds_Availble[Millet] =

ESE_Annual__Seed_Sales_In_Quintals[Millet]+*Estimated_Reginal_Production_of_improved_Seed[Millet]*

UNITS: quintal/year

Improvrd_Cereal__Seeds_Availble[Oats] =

ESE_Annual__Seed_Sales_In_Quintals[Oats]+*Estimated_Reginal_Production_of_improved_Seed[Oats]*

UNITS: quintal/year

$InherentYield_fraction_Marginal_Suitable_Land = 0.4$

$Inherent_Comulative_Yield =$

$Land_Degradation_series.Percentage_of_high_Productive_Land*Productive_Land_Inherent_Yield+Land_Degradation_series.percentage_of_Moderately_Suitable_Land*Moderately_Suitable_Inherent_Yield+Land_Degradation_series.percentage_of_Suitable_Land*Suitable_InherentYield+Land_Degradation_series.percentage_of_Marginal_Suitable_Land*Marginal_Suitable_Inherent_Yield+Land_Degradation_series.percentage_of_Non_Suitable_Land*Non_Suitable_Inherent_Yield$

$Inherent_Yield = 12.5$

$Inherent_Yield_fraction_Moderately_Suitable_Land = 0.6$

$InherentYield_fraction_Suitable_Land = 0.8$

$InputCapacity_Adjustment_Time[Fertilizer] = 2$

$InputCapacity_Adjustment_Time[Improved_Seed] = 3.5$

$Inputs_Price_per_Quintal[Fertilizer] = Retailer_Dap_price_Birr_pe_Quintal$

UNITS: birr/quintal

$Inputs_Price_per_Quintal[Improved_Seed] = Estimated_Improved_seed_Price_Birr_per_Quintal$

UNITS: birr/quintal

$Input_Shares_of_Cereal_Types[Tef, Fertilizer] = Cereal_Fertilizer_Input_share[Tef]$

$Input_Shares_of_Cereal_Types[Tef, Improved_Seed] = Cereal_Improved_Seed_Sale[Tef]$

$Input_Shares_of_Cereal_Types[Wheat, Fertilizer] = Cereal_Fertilizer_Input_share[Wheat]$

$Input_Shares_of_Cereal_Types[Wheat, Improved_Seed] = Cereal_Improved_Seed_Sale[Wheat]$

$Input_Shares_of_Cereal_Types[Maize, Fertilizer] = Cereal_Fertilizer_Input_share[Maize]$

$Input_Shares_of_Cereal_Types[Maize, Improved_Seed] = Cereal_Improved_Seed_Sale[Maize]$

$Input_Shares_of_Cereal_Types[Barely, Fertilizer] = Cereal_Fertilizer_Input_share[Barely]$

$Input_Shares_of_Cereal_Types[Barely, Improved_Seed] = Cereal_Improved_Seed_Sale[Barely]$

$Input_Shares_of_Cereal_Types[Rice, Fertilizer] = Cereal_Fertilizer_Input_share[Rice]$

$Input_Shares_of_Cereal_Types[Rice, Improved_Seed] = Cereal_Improved_Seed_Sale[Rice]$

$Input_Shares_of_Cereal_Types[Sorghum, Fertilizer] = Cereal_Fertilizer_Input_share[Sorghum]$

$Input_Shares_of_Cereal_Types[Sorghum, Improved_Seed] = Cereal_Improved_Seed_Sale[Sorghum]$

$Input_Shares_of_Cereal_Types[Millet, Fertilizer] = Cereal_Fertilizer_Input_share[Millet]$

$Input_Shares_of_Cereal_Types[Millet, Improved_Seed] = Cereal_Improved_Seed_Sale[Millet]$

$Input_Shares_of_Cereal_Types[Oats, Fertilizer] = Cereal_Fertilizer_Input_share[Oats]$

$Input_Shares_of_Cereal_Types[Oats, Improved_Seed] = Cereal_Improved_Seed_Sale[Oats]$

$Input_Supply[Fertilizer] = ((1 - Policy2_Activated) * Fertilizer_Available_for_cereal) + (Policy2_Activated * Effective_Input_Available[Fertilizer])$

UNITS: quintal/year

$Input_Supply[Improved_Seed] = ((1 - Policy2_Activated) * (Improvr_Cereal_Seeds_Available[Tef] + Improvr_Cereal_Seeds_Available[Wheat] + Improvr_Cereal_Seeds_Available[Maize] + Improvr_Cereal_Seeds_Available[Barely] + Improvr_Cereal_Seeds_Available[Rice] + Improvr_Cereal_Seeds_Available[Sorghum] + Improvr_Cereal_Seeds_Available[Millet] + Improvr_Cereal_Seeds_Available[Oats])) + (Policy2_Activated * 1) * Effective_Input_Available[Improved_Seed]$

UNITS: quintal/year

$Input_Adjustment_Time = 0.8$

$Input_Capacity_Gap[Fertilizer] = MAX(0, Desired_Capacity[Fertilizer] - Functioning_cupacity[Fertilizer])$

$Input_Capacity_Gap[Improved_Seed] = MAX(0, Desired_Capacity[Improved_Seed] - Functioning_cupacity[Improved_Seed])$

$Intial_Input_using_Fraction[Fertilizer] = 0.15$

UNITS: per year (1/yr)

$Intial_Input_using_Fraction[Improved_Seed] = 0.15$

UNITS: per year (1/yr)

$Maize_yield = GRAPH(TIME)$

(1995, 19.8), (1996, 19.2), (1997, 17.5), (1998, 18.6), (1999, 17.9), (2000, 18.3), (2001, 21.2), (2002, 15.0), (2003, 18.6), (2004, 17.2), (2005, 21.9), (2006, 22.3), (2007, 21.2), (2008, 22.2), (2009, 22.0), (2010, 25.4)

$Maize_Seed = GRAPH(TIME)$

(1995, 40571), (1996, 40571), (1997, 41905), (1998, 40762), (1999, 41143), (2000, 40190), (2001, 40190), (2002, 59133), (2003, 50654), (2004, 48791), (2005, 46650), (2006, 54748), (2007, 41934), (2008, 55048), (2009, 77429), (2010, 88000)

$Marginal_Suitable_Inherent_Yield = InherentYield_fraction_Marginal_Suitable_Land * Inherent_Yield$

$Millet_Yield = GRAPH(TIME)$

(1995, 8.96), (1996, 10.2), (1997, 8.93), (1998, 8.54), (1999, 8.87), (2000, 9.12), (2001, 10.9), (2002, 10.0), (2003, 10.0), (2004, 10.6), (2005, 11.9), (2006, 12.9), (2007, 13.5), (2008, 13.7), (2009, 14.2), (2010, 15.6)

$Millet_seed = GRAPH(TIME)$

(1995, 0.00), (1996, 0.00), (1997, 0.00), (1998, 0.00), (1999, 0.00), (2000, 0.00), (2001, 0.00), (2002, 2.00), (2003, 12.0), (2004, 37.1), (2005, 26.0), (2006, 234), (2007, 387), (2008, 708), (2009, 927), (2010, 981)

$Moderatly_Suitable_Inherent_ield = Inherent_Yield_fraction_Moderatly_Suitable_Land * Inherent_Yield$

$Non_Suitable_Inherent_Yield = Potential_Yield_fraction_Non_Suitable_Land * Inherent_Yield$

Oats_Yield = GRAPH(TIME)

(1995, 14.5), (1996, 11.1), (1997, 10.3), (1998, 8.96), (1999, 10.3), (2000, 12.1), (2001, 11.2), (2002, 8.38), (2003, 12.9), (2004, 12.6), (2005, 9.05), (2006, 11.1), (2007, 12.0), (2008, 14.0), (2009, 13.8), (2010, 15.4)

UNITS: quintal/hectare

Oats__seed = GRAPH(TIME)

(1995, 0.00), (1996, 0.00), (1997, 0.00), (1998, 0.00), (1999, 0.00), (2000, 0.00), (2001, 0.00), (2002, 0.00), (2003, 0.00), (2004, 0.00), (2005, 0.00), (2006, 0.00), (2007, 0.00), (2008, 0.00), (2009, 0.00), (2010, 0.00)

Percieved_Potential_Input__Covered_land =
SMTH1(.Desired_Cultivation_area_for_input_covered,Time_to_Percieve)

Policy2_Activated = if(Policy_switch_2=1)and(time>Policy_Start_Time)then(1)else(0)

Policy_Start_Time = 2014

Policy_switch_2 = 0

Potential_Yield_fraction__Non_Suitable_Land = 0.2

Previous_year_fertilizer_used_in_quintals_per_Ha = SMTH1(fertiliser_used_In_Quintalsper_Ha,1)

Previous_year__yield_both_inputs[Tef] = SMTH1(Yield_with__both_inputs[Tef],1)

Previous_year__yield_both_inputs[Wheat] = SMTH1(Yield_with__both_inputs[Wheat],1)

Previous_year__yield_both_inputs[Maize] = SMTH1(Yield_with__both_inputs[Maize],1)

Previous_year__yield_both_inputs[Barely] = SMTH1(Yield_with__both_inputs[Barely],1)

Previous_year__yield_both_inputs[Rice] = SMTH1(Yield_with__both_inputs[Rice],1)

Previous_year__yield_both_inputs[Sorghum] = SMTH1(Yield_with__both_inputs[Sorghum],1)

Previous_year__yield_both_inputs[Millet] = SMTH1(Yield_with__both_inputs[Millet],1)

Previous_year__yield_both_inputs[Oats] = SMTH1(Yield_with__both_inputs[Oats],1)

Previous_yield_with_only_fertilizer[Tef] = SMTH1(Yield_with__only_Fertilizer[Tef],1)

Previous_yield_with_only_fertilizer[Wheat] = SMTH1(Yield_with__only_Fertilizer[Wheat],1)

Previous_yield_with_only_fertilizer[Maize] = SMTH1(Yield_with__only_Fertilizer[Maize],1)

Previous_yield_with_only_fertilizer[Barely] = SMTH1(Yield_with__only_Fertilizer[Barely],1)

Previous_yield_with_only_fertilizer[Rice] = SMTH1(Yield_with__only_Fertilizer[Rice],1)

Previous_yield_with_only_fertilizer[Sorghum] = SMTH1(Yield_with__only_Fertilizer[Sorghum],1)

Previous_yield_with_only_fertilizer[Millet] = SMTH1(Yield_with__only_Fertilizer[Millet],1)

Previous_yield_with_only_fertilizer[Oats] = SMTH1(Yield_with__only_Fertilizer[Oats],1)

Productive_Land__Inherent_Yield = *Inherent_Yield*

$Relative_Inherent_Comulative_Yield = Inherent_Comulative_Yield/INIT(Inherent_Comulative_Yield)$

UNITS: Unitless

$Relative_yield = Average_Yield/INIT(Average_Yield)$

UNITS: Unitless

$Relative_Intensity_of_Fertilizer_used =$
 $Average_Amount_of_Inputs_Quintals_per_Ha[Fertilizer]/INIT(Average_Amount_of_Inputs_Quintals_per_Ha[Fertilizer])$

UNITS: Unitless

$Retailer_Dap_price_Birr_pe_Quintal = GRAPH(TIME)$

(1995, 164), (1996, 200), (1997, 255), (1998, 245), (1999, 264), (2000, 290), (2001, 273), (2002, 255), (2003, 258), (2004, 309), (2005, 364), (2006, 367), (2007, 384), (2008, 770), (2009, 703), (2010, 719)

UNITS: birr/quintal

$Rice_Yield = GRAPH(TIME)$

(1995, 0.00), (1996, 0.00), (1997, 0.00), (1998, 0.00), (1999, 0.00), (2000, 0.00), (2001, 18.4), (2002, 0.00), (2003, 0.00), (2004, 0.00), (2005, 18.0), (2006, 0.00), (2007, 29.2), (2008, 20.4), (2009, 21.6), (2010, 30.3)

UNITS: quintal/year-hectare

$Rice_Seed = GRAPH(TIME)$

(1995, 0.00), (1996, 0.00), (1997, 0.00), (1998, 0.00), (1999, 0.00), (2000, 0.00), (2001, 0.00), (2002, 0.00), (2003, 0.00), (2004, 0.00), (2005, 0.00), (2006, 0.00), (2007, 0.00), (2008, 0.00), (2009, 42.0), (2010, 300)

$Seed_and_loss_fraction = 0.3$

UNITS: Unitless

$Seed_Production_Share_ofMaize = Maize_Seed/Total_Improved_Seeds_Produced$

$Seed_Production_Share_ofMillet = Millet_seed/Total_Improved_Seeds_Produced$

$Seed_Production_Share_ofBarley = Barely_Seed/Total_Improved_Seeds_Produced$

$Seed_Production_Share_ofOats = Oats_seed/Total_Improved_Seeds_Produced$

$Seed_Production_Share_ofRice = Rice_Seed/Total_Improved_Seeds_Produced$

$Seed_Production_Share_ofSorghum = Sorghum_Seed/Total_Improved_Seeds_Produced$

$Seed_Production_Share_ofTef = Tef_Seed/Total_Improved_Seeds_Produced$

$Seed_Production_Share_ofWheat = Wheat_Seed/Total_Improved_Seeds_Produced$

$Share_ofCereal_Cultivated_Ha_With_input[Tef, Fertilizer] = Hectars_Coverd_by_type_of_cereals[Tef, Fertilizer]/Cereal_Cultivated_Hectars[Tef]$

UNITS: Unitless

$Share_of_Cereal_Cultivated_Ha_With_input[Tef, Improved_Seed] = Hectars_Coverd_by_type_of_cereals[Tef, Improved_Seed]/Cereal_Cultivated_Hectars[Tef]$

UNITS: Unitless

$Share_of_Cereal_Cultivated_Ha_With_input[Wheat, Fertilizer] = Hectars_Coverd_by_type_of_cereals[Wheat, Fertilizer]/Cereal_Cultivated_Hectars[Wheat]$

UNITS: Unitless

$Share_of_Cereal_Cultivated_Ha_With_input[Wheat, Improved_Seed] = Hectars_Coverd_by_type_of_cereals[Wheat, Improved_Seed]/Cereal_Cultivated_Hectars[Wheat]$

UNITS: Unitless

$Share_of_Cereal_Cultivated_Ha_With_input[Maize, Fertilizer] = Hectars_Coverd_by_type_of_cereals[Maize, Fertilizer]/Cereal_Cultivated_Hectars[Maize]$

UNITS: Unitless

$Share_of_Cereal_Cultivated_Ha_With_input[Maize, Improved_Seed] = Hectars_Coverd_by_type_of_cereals[Maize, Improved_Seed]/Cereal_Cultivated_Hectars[Maize]$

UNITS: Unitless

$Share_of_Cereal_Cultivated_Ha_With_input[Barely, Fertilizer] = Hectars_Coverd_by_type_of_cereals[Barely, Fertilizer]/Cereal_Cultivated_Hectars[Barely]$

UNITS: Unitless

$Share_of_Cereal_Cultivated_Ha_With_input[Barely, Improved_Seed] = Hectars_Coverd_by_type_of_cereals[Barely, Improved_Seed]/Cereal_Cultivated_Hectars[Barely]$

UNITS: Unitless

$Share_of_Cereal_Cultivated_Ha_With_input[Rice, Fertilizer] = Hectars_Coverd_by_type_of_cereals[Rice, Fertilizer]/Cereal_Cultivated_Hectars[Rice]$

UNITS: Unitless

$Share_of_Cereal_Cultivated_Ha_With_input[Rice, Improved_Seed] = Hectars_Coverd_by_type_of_cereals[Rice, Improved_Seed]/Cereal_Cultivated_Hectars[Rice]$

UNITS: Unitless

$Share_of_Cereal_Cultivated_Ha_With_input[Sorghum, Fertilizer] = Hectars_Coverd_by_type_of_cereals[Sorghum, Fertilizer]/Cereal_Cultivated_Hectars[Sorghum]$

UNITS: Unitless

$Share_of_Cereal_Cultivated_Ha_With_input[Sorghum, Improved_Seed] = Hectars_Coverd_by_type_of_cereals[Sorghum, Improved_Seed]/Cereal_Cultivated_Hectars[Sorghum]$

UNITS: Unitless

$Share_of_Cereal_Cultivated_Ha_With_input[Millet, Fertilizer] = Hectars_Coverd_by_type_of_cereals[Millet, Fertilizer]/Cereal_Cultivated_Hectars[Millet]$

UNITS: Unitless

$Share_of_Cereal_Cultivated_Ha_With_input[Millet, Improved_Seed] = Hectars_Coverd_by_type_of_cereals[Millet, Improved_Seed]/Cereal_Cultivated_Hectars[Millet]$

UNITS: Unitless

$Share_of_Cereal_Cultivated_Ha_With_input[Oats, Fertilizer] = Hectars_Coverd_by_type_of_cereals[Oats, Fertilizer]/Cereal_Cultivated_Hectars[Oats]$

UNITS: Unitless

$Share_of_Cereal_Cultivated_Ha_With_input[Oats, Improved_Seed] = Hectars_Coverd_by_type_of_cereals[Oats, Improved_Seed]/Cereal_Cultivated_Hectars[Oats]$

UNITS: Unitless

$Share_of_Cereal_fertilizer_Availeblity = GRAPH(TIME)$

(1995, 0.45), (2000, 0.48), (2005, 0.05), (2010, 0.02)

UNITS: quintal/year

$Share_of_Cereal_Ha_only_Fertilizer[Tef] = MAX(Share_of_Cereal_Cultivated_Ha_With_input[Tef, Fertilizer], Share_of_Cereal_Cultivated_Ha_With_input[Tef, Improved_Seed]) - MIN(Share_of_Cereal_Cultivated_Ha_With_input[Tef, Fertilizer], Share_of_Cereal_Cultivated_Ha_With_input[Tef, Improved_Seed])$

UNITS: Unitless

$Share_of_Cereal_Ha_only_Fertilizer[Wheat] = MAX(Share_of_Cereal_Cultivated_Ha_With_input[Wheat, Fertilizer], Share_of_Cereal_Cultivated_Ha_With_input[Wheat, Improved_Seed]) - MIN(Share_of_Cereal_Cultivated_Ha_With_input[Wheat, Fertilizer], Share_of_Cereal_Cultivated_Ha_With_input[Wheat, Improved_Seed])$

UNITS: Unitless

$Share_of_Cereal_Ha_only_Fertilizer[Maize] = MAX(Share_of_Cereal_Cultivated_Ha_With_input[Maize, Fertilizer], Share_of_Cereal_Cultivated_Ha_With_input[Maize, Improved_Seed]) - MIN(Share_of_Cereal_Cultivated_Ha_With_input[Maize, Fertilizer], Share_of_Cereal_Cultivated_Ha_With_input[Maize, Improved_Seed])$

UNITS: Unitless

$Share_of_Cereal_Ha_only_Fertilizer[Barely] = MAX(Share_of_Cereal_Cultivated_Ha_With_input[Barely, Fertilizer], Share_of_Cereal_Cultivated_Ha_With_input[Barely, Improved_Seed]) - MIN(Share_of_Cereal_Cultivated_Ha_With_input[Barely, Fertilizer], Share_of_Cereal_Cultivated_Ha_With_input[Barely, Improved_Seed])$

UNITS: Unitless

$Share_of_Cereal_Ha_only_Fertilizer[Rice] = MAX(Share_of_Cereal_Cultivated_Ha_With_input[Rice, Fertilizer], Share_of_Cereal_Cultivated_Ha_With_input[Rice, Improved_Seed]) - MIN(Share_of_Cereal_Cultivated_Ha_With_input[Rice, Fertilizer], Share_of_Cereal_Cultivated_Ha_With_input[Rice, Improved_Seed])$

UNITS: Unitless

*Share_of_Cereal_Ha_only_Fertilizer[Sorghum] =
MAX(Share_of_Cereal_Cultivated__Ha_With_input[Sorghum,
Fertilizer],Share_of_Cereal_Cultivated__Ha_With_input[Sorghum, Improved_Seed])-
MIN(Share_of_Cereal_Cultivated__Ha_With_input[Sorghum,
Fertilizer],Share_of_Cereal_Cultivated__Ha_With_input[Sorghum, Improved_Seed])*

UNITS: Unitless

*Share_of_Cereal_Ha_only_Fertilizer[Millet] = MAX(Share_of_Cereal_Cultivated__Ha_With_input[Millet,
Fertilizer],Share_of_Cereal_Cultivated__Ha_With_input[Millet, Improved_Seed])-
MIN(Share_of_Cereal_Cultivated__Ha_With_input[Millet,
Fertilizer],Share_of_Cereal_Cultivated__Ha_With_input[Millet, Improved_Seed])*

UNITS: Unitless

*Share_of_Cereal_Ha_only_Fertilizer[Oats] = MAX(Share_of_Cereal_Cultivated__Ha_With_input[Oats,
Fertilizer],Share_of_Cereal_Cultivated__Ha_With_input[Oats, Improved_Seed])-
MIN(Share_of_Cereal_Cultivated__Ha_With_input[Oats,
Fertilizer],Share_of_Cereal_Cultivated__Ha_With_input[Oats, Improved_Seed])*

UNITS: Unitless

*Share_of_Cereal__Ha_both_Inputs[Tef] = Min(Share_of_Cereal_Cultivated__Ha_With_input[Tef,
Fertilizer],Share_of_Cereal_Cultivated__Ha_With_input[Tef, Improved_Seed])*

UNITS: Unitless

*Share_of_Cereal__Ha_both_Inputs[Wheat] = Min(Share_of_Cereal_Cultivated__Ha_With_input[Wheat,
Fertilizer],Share_of_Cereal_Cultivated__Ha_With_input[Wheat, Improved_Seed])*

UNITS: Unitless

*Share_of_Cereal__Ha_both_Inputs[Maize] = Min(Share_of_Cereal_Cultivated__Ha_With_input[Barely,
Fertilizer],Share_of_Cereal_Cultivated__Ha_With_input[Maize, Improved_Seed])*

UNITS: Unitless

*Share_of_Cereal__Ha_both_Inputs[Barely] = Min(Share_of_Cereal_Cultivated__Ha_With_input[Barely,
Fertilizer],Share_of_Cereal_Cultivated__Ha_With_input[Barely, Improved_Seed])*

UNITS: Unitless

*Share_of_Cereal__Ha_both_Inputs[Rice] = Min(Share_of_Cereal_Cultivated__Ha_With_input[Rice,
Fertilizer],Share_of_Cereal_Cultivated__Ha_With_input[Tef, Improved_Seed])*

UNITS: Unitless

*Share_of_Cereal__Ha_both_Inputs[Sorghum] = Min(Share_of_Cereal_Cultivated__Ha_With_input[Sorghum,
Fertilizer],Share_of_Cereal_Cultivated__Ha_With_input[Sorghum, Improved_Seed])*

UNITS: Unitless

*Share_of_Cereal__Ha_both_Inputs[Millet] = Min(Share_of_Cereal_Cultivated__Ha_With_input[Millet,
Fertilizer],Share_of_Cereal_Cultivated__Ha_With_input[Millet, Improved_Seed])*

UNITS: Unitless

$Share_of_Cereal_Ha_both_Inputs[Oats] = Min(Share_of_Cereal_Cultivated_Ha_With_input[Oats, Fertilizer], Share_of_Cereal_Cultivated_Ha_With_input[Oats, Improved_Seed])$

UNITS: Unitless

$Share_of_Cereal_Ha_no_Inputs[Tef] = 1-MAX(Share_of_Cereal_Cultivated_Ha_With_input[Tef, Fertilizer], Share_of_Cereal_Cultivated_Ha_With_input[Tef, Improved_Seed])$

UNITS: Unitless

$Share_of_Cereal_Ha_no_Inputs[Wheat] = 1-MAX(Share_of_Cereal_Cultivated_Ha_With_input[Wheat, Fertilizer], Share_of_Cereal_Cultivated_Ha_With_input[Wheat, Improved_Seed])$

UNITS: Unitless

$Share_of_Cereal_Ha_no_Inputs[Maize] = 1-MAX(Share_of_Cereal_Cultivated_Ha_With_input[Maize, Fertilizer], Share_of_Cereal_Cultivated_Ha_With_input[Maize, Improved_Seed])$

UNITS: Unitless

$Share_of_Cereal_Ha_no_Inputs[Barely] = 1-MAX(Share_of_Cereal_Cultivated_Ha_With_input[Barely, Fertilizer], Share_of_Cereal_Cultivated_Ha_With_input[Barely, Improved_Seed])$

UNITS: Unitless

$Share_of_Cereal_Ha_no_Inputs[Rice] = 1-MAX(Share_of_Cereal_Cultivated_Ha_With_input[Rice, Fertilizer], Share_of_Cereal_Cultivated_Ha_With_input[Rice, Improved_Seed])$

UNITS: Unitless

$Share_of_Cereal_Ha_no_Inputs[Sorghum] = 1-MAX(Share_of_Cereal_Cultivated_Ha_With_input[Sorghum, Fertilizer], Share_of_Cereal_Cultivated_Ha_With_input[Sorghum, Improved_Seed])$

UNITS: Unitless

$Share_of_Cereal_Ha_no_Inputs[Millet] = 1-MAX(Share_of_Cereal_Cultivated_Ha_With_input[Millet, Fertilizer], Share_of_Cereal_Cultivated_Ha_With_input[Millet, Improved_Seed])$

UNITS: Unitless

$Share_of_Cereal_Ha_no_Inputs[Oats] = 1-MAX(Share_of_Cereal_Cultivated_Ha_With_input[Oats, Fertilizer], Share_of_Cereal_Cultivated_Ha_With_input[Oats, Improved_Seed])$

UNITS: Unitless

$Share_of_reginal_Improved_Seed_production = GRAPH(TIME)$

(0.00, 0.00), (4.00, 0.00), (8.00, 0.004), (12.0, 0.0925)

$Sorghum_Yield = GRAPH(TIME)$

(1995, 13.8), (1996, 14.3), (1997, 11.2), (1998, 12.7), (1999, 11.9), (2000, 11.5), (2001, 13.7), (2002, 9.70), (2003, 13.6), (2004, 13.7), (2005, 14.8), (2006, 15.8), (2007, 17.3), (2008, 17.4), (2009, 17.4), (2010, 20.9)

UNITS: quintal/year-hectare

$Sorghum_Seed = GRAPH(TIME)$

(1995, 197), (1996, 197), (1997, 203), (1998, 197), (1999, 203), (2000, 203), (2001, 210), (2002, 190), (2003, 189), (2004, 443), (2005, 139), (2006, 279), (2007, 787), (2008, 1740), (2009, 2587), (2010, 2764)

Sorghum__Fertilizer_Share = GRAPH(TIME)

(1995, 0.05), (2000, 0.05), (2005, 0.05), (2010, 0.07)

Suitable__InherentYield = *InherentYield_fraction_Suitable_Land*Inherent_Yield*

Tef_Yield = GRAPH(TIME)

(1995, 8.35), (1996, 9.23), (1997, 7.48), (1998, 7.85), (1999, 8.08), (2000, 7.95), (2001, 8.94), (2002, 7.35), (2003, 8.43), (2004, 9.48), (2005, 9.68), (2006, 10.1), (2007, 11.7), (2008, 12.2), (2009, 12.3), (2010, 12.6)

Tef__Seed = GRAPH(TIME)

(1995, 2413), (1996, 2349), (1997, 2540), (1998, 2222), (1999, 2730), (2000, 2286), (2001, 2413), (2002, 2349), (2003, 1968), (2004, 2072), (2005, 3527), (2006, 5816), (2007, 11111), (2008, 19860), (2009, 31194), (2010, 33892)

Tef__Fertilizer_Share = GRAPH(TIME)

(0.00, 0.36), (4.00, 0.36), (8.00, 0.36), (12.0, 0.37)

Thousand_Ha__Unit_Adjustment = 1000

UNITS: Unitless

Time_to_Percieve = 1

Total_Improved__Seeds_Produced =

ESE_Annual__Seed_Sales_In_Quintals[Tef]+ESE_Annual__Seed_Sales_In_Quintals[Wheat]+ESE_Annual__Seed_Sales_In_Quintals[Maize]+ESE_Annual__Seed_Sales_In_Quintals[Barely]+ESE_Annual__Seed_Sales_In_Quintals[Rice]+ESE_Annual__Seed_Sales_In_Quintals[Sorghum]+ESE_Annual__Seed_Sales_In_Quintals[Millet]+ESE_Annual__Seed_Sales_In_Quintals[Oats]

Total_Input__coverage[Fertilizer] =

Adapted__Cultivation_Area[Fertilizer]/.Cereal_Cultivated__Area_in_thousand_Ha

Total_Input__coverage[Improved_Seed] =

Adapted__Cultivation_Area[Improved_Seed]/.Cereal_Cultivated__Area_in_thousand_Ha

Unit_Adjustment__thousand = 1000

Unit_Production_Capacity[Fertilizer] = 950

Unit_Production_Capacity[Improved_Seed] = 1000

Unit__Adjustment_000 = 1000

Wheat_Yield = GRAPH(TIME)

(1995, 12.2), (1996, 13.0), (1997, 14.1), (1998, 11.3), (1999, 11.8), (2000, 13.8), (2001, 14.4), (2002, 10.7), (2003, 14.7), (2004, 15.6), (2005, 15.2), (2006, 16.7), (2007, 16.3), (2008, 17.5), (2009, 18.3), (2010, 18.4)

Wheat__Seed = GRAPH(TIME)

(1995, 26286), (1996, 26286), (1997, 29206), (1998, 30667), (1999, 30667), (2000, 31397), (2001, 33587), (2002, 91063), (2003, 138937), (2004, 64234), (2005, 115888), (2006, 75602), (2007, 121748), (2008, 228540), (2009, 355873), (2010, 377587)

Yield_with_improved_seed_and_Fertilizer[Tef] = 19

UNITS: quintal/year-hectare

Yield_with_improved_seed_and_Fertilizer[Wheat] = 25

UNITS: quintal/year-hectare

Yield_with_improved_seed_and_Fertilizer[Maize] = 22

UNITS: quintal/year-hectare

Yield_with_improved_seed_and_Fertilizer[Barely] = 21

UNITS: quintal/year-hectare

Yield_with_improved_seed_and_Fertilizer[Rice] = 27

UNITS: quintal/year-hectare

Yield_with_improved_seed_and_Fertilizer[Sorghum] = 20

UNITS: quintal/year-hectare

Yield_with_improved_seed_and_Fertilizer[Millet] = 18

UNITS: quintal/year-hectare

Yield_with_improved_seed_and_Fertilizer[Oats] = 0

UNITS: quintal/year-hectare

Yield_with_only__Fertilizer[Tef] = 10.5

UNITS: quintal/year-hectare

Yield_with_only__Fertilizer[Wheat] = 16.5

UNITS: quintal/year-hectare

Yield_with_only__Fertilizer[Maize] = 20.5

UNITS: quintal/year-hectare

Yield_with_only__Fertilizer[Barely] = 15.5

UNITS: quintal/year-hectare

Yield_with_only__Fertilizer[Rice] = 17

UNITS: quintal/year-hectare

Yield_with_only__Fertilizer[Sorghum] = 15

UNITS: quintal/year-hectare

Yield_with_only__Fertilizer[Millet] = 14

UNITS: quintal/year-hectare

Yield_with_only__Fertilizer[Oats] = 12

UNITS: quintal/year-hectare

yield_with_out__Improved_inputs[Tef] = 6.5

UNITS: quintal/year-hectare

yield_with_out__Improved_inputs[Wheat] = 10

UNITS: quintal/year-hectare

yield_with_out__Improved_inputs[Maize] = 16.6

UNITS: quintal/year-hectare

yield_with_out__Improved_inputs[Barely] = 8.5

UNITS: quintal/year-hectare

yield_with_out__Improved_inputs[Rice] = 0

UNITS: quintal/year-hectare

yield_with_out__Improved_inputs[Sorghum] = 12.5

UNITS: quintal/year-hectare

yield_with_out__Improved_inputs[Millet] = 6.25

UNITS: quintal/year-hectare

yield_with_out__Improved_inputs[Oats] = 10

UNITS: quintal/year-hectare

Yield_with__both_inputs[Tef] =

*Yield_with_improved_seed_and_Fertilizer[Tef]*Relative__Intensity_of_Fertilizer_used^Elasticity_of_Yield_for
_improved_Seed_and_Fertilizer[Tef]*Relative_Inherent_Comulative_Yield*Effect_of__rainfall_on_yield*

UNITS: quintal/year-hectare

Yield_with__both_inputs[Wheat] =

*Yield_with_improved_seed_and_Fertilizer[Wheat]*Relative__Intensity_of_Fertilizer_used^Elasticity_of_Yield_f
or_improved_Seed_and_Fertilizer[Wheat]*Relative_Inherent_Comulative_Yield*Effect_of__rainfall_on_yield*

UNITS: quintal/year-hectare

Yield_with__both_inputs[Maize] =

*Yield_with_improved_seed_and_Fertilizer[Maize]*Relative__Intensity_of_Fertilizer_used^Elasticity_of_Yield_f
or_improved_Seed_and_Fertilizer[Maize]*Relative_Inherent_Comulative_Yield*Effect_of__rainfall_on_yield*

UNITS: quintal/year-hectare

$Yield_with_both_inputs[Barely] = Yield_with_improved_seed_and_Fertilizer[Barely] * Relative_Intensity_of_Fertilizer_used^{Elasticity_of_Yield_for_improved_Seed_and_Fertilizer[Barely]} * Relative_Inherent_Comulative_Yield * Effect_of_rainfall_on_yield$

UNITS: quintal/year-hectare

$Yield_with_both_inputs[Rice] = Yield_with_improved_seed_and_Fertilizer[Rice] * Relative_Intensity_of_Fertilizer_used^{Elasticity_of_Yield_for_improved_Seed_and_Fertilizer[Rice]} * Relative_Inherent_Comulative_Yield * Effect_of_rainfall_on_yield$

UNITS: quintal/year-hectare

$Yield_with_both_inputs[Sorghum] = Yield_with_improved_seed_and_Fertilizer[Sorghum] * Relative_Intensity_of_Fertilizer_used^{Elasticity_of_Yield_for_improved_Seed_and_Fertilizer[Sorghum]} * Relative_Inherent_Comulative_Yield * Effect_of_rainfall_on_yield$

UNITS: quintal/year-hectare

$Yield_with_both_inputs[Millet] = Yield_with_improved_seed_and_Fertilizer[Millet] * Relative_Intensity_of_Fertilizer_used^{Elasticity_of_Yield_for_improved_Seed_and_Fertilizer[Millet]} * Relative_Inherent_Comulative_Yield * Effect_of_rainfall_on_yield$

UNITS: quintal/year-hectare

$Yield_with_both_inputs[Oats] = Yield_with_improved_seed_and_Fertilizer[Oats] * Relative_Intensity_of_Fertilizer_used^{Elasticity_of_Yield_for_improved_Seed_and_Fertilizer[Oats]} * Relative_Inherent_Comulative_Yield * Effect_of_rainfall_on_yield$

UNITS: quintal/year-hectare

$Yield_with_no_input[Tef] = yield_with_out_Improved_inputs[Tef] * Relative_Inherent_Comulative_Yield * Effect_of_rainfall_on_yield$

UNITS: quintal/year-hectare

$Yield_with_no_input[Wheat] = yield_with_out_Improved_inputs[Wheat] * Relative_Inherent_Comulative_Yield * Effect_of_rainfall_on_yield$

UNITS: quintal/year-hectare

$Yield_with_no_input[Maize] = yield_with_out_Improved_inputs[Maize] * Relative_Inherent_Comulative_Yield * Effect_of_rainfall_on_yield$

UNITS: quintal/year-hectare

$Yield_with_no_input[Barely] = yield_with_out_Improved_inputs[Barely] * Relative_Inherent_Comulative_Yield * Effect_of_rainfall_on_yield$

UNITS: quintal/year-hectare

$Yield_with_no_input[Rice] = yield_with_out_Improved_inputs[Rice] * Relative_Inherent_Comulative_Yield * Effect_of_rainfall_on_yield$

UNITS: quintal/year-hectare

$Yield_with_no_input[Sorghum] = yield_with_out_Improved_inputs[Sorghum]*Relative_Inherent_Comulative_Yield*Effect_of_rainfall_on_yield$

UNITS: quintal/year-hectare

$Yield_with_no_input[Millet] = yield_with_out_Improved_inputs[Millet]*Relative_Inherent_Comulative_Yield*Effect_of_rainfall_on_yield$

UNITS: quintal/year-hectare

$Yield_with_no_input[Oats] = yield_with_out_Improved_inputs[Oats]*Relative_Inherent_Comulative_Yield*Effect_of_rainfall_on_yield$

UNITS: quintal/year-hectare

$Yield_with_only_Fertilizer[Tef] = Yield_with_only_Fertilizer[Tef]*Relative_Intensity_of_Fertilizer_used^Elasticity_of_yield_for_fertilizer[Tef]*Relative_Inherent_Comulative_Yield*Effect_of_rainfall_on_yield$

UNITS: quintal/year-hectare

$Yield_with_only_Fertilizer[Wheat] = Yield_with_only_Fertilizer[Wheat]*Relative_Intensity_of_Fertilizer_used^Elasticity_of_yield_for_fertilizer[Wheat]*Relative_Inherent_Comulative_Yield*Effect_of_rainfall_on_yield$

UNITS: quintal/year-hectare

$Yield_with_only_Fertilizer[Maize] = Yield_with_only_Fertilizer[Maize]*Relative_Intensity_of_Fertilizer_used^Elasticity_of_yield_for_fertilizer[Maize]*Relative_Inherent_Comulative_Yield*Effect_of_rainfall_on_yield$

UNITS: quintal/year-hectare

$Yield_with_only_Fertilizer[Barely] = Yield_with_only_Fertilizer[Barely]*Relative_Intensity_of_Fertilizer_used^Elasticity_of_yield_for_fertilizer[Barely]^Relative_Inherent_Comulative_Yield*Effect_of_rainfall_on_yield$

UNITS: quintal/year-hectare

$Yield_with_only_Fertilizer[Rice] = Yield_with_only_Fertilizer[Rice]*Relative_Intensity_of_Fertilizer_used^Elasticity_of_yield_for_fertilizer[Rice]*Relative_Inherent_Comulative_Yield*Effect_of_rainfall_on_yield$

UNITS: quintal/year-hectare

$Yield_with_only_Fertilizer[Sorghum] = Yield_with_only_Fertilizer[Sorghum]*Relative_Intensity_of_Fertilizer_used^Elasticity_of_yield_for_fertilizer[Sorghum]*Relative_Inherent_Comulative_Yield*Effect_of_rainfall_on_yield$

UNITS: quintal/year-hectare

$Yield_with_only_Fertilizer[Millet] = Yield_with_only_Fertilizer[Millet]*Relative_Intensity_of_Fertilizer_used^Elasticity_of_yield_for_fertilizer[Millet]*Relative_Inherent_Comulative_Yield*Effect_of_rainfall_on_yield$

UNITS: quintal/year-hectare

*Yield_with_only_Fertilizer[Oats] =
Yield_with_only__Fertilizer[Oats]*Relative__Intensity_of_Fertilizer_used^Elasticity_of_yield_for_fertilizer[Oa
ts]*Relative_Inherent_Comulative_Yield*Effect_of__rainfall_on_yield*

UNITS: quintal/year-hectare