

**Non-Revenue Water Reduction Programs in Colombia:
Methodology Analysis using a System Dynamics Approach.**

Juan Camilo Barrera Ramírez

juancamilobarrera@gmail.com

M.Phil. Thesis in System Dynamics

Supervisor:

Prof. Pål I. Davidsen

Faculty of Social Sciences

University of Bergen

June, 2008



**Non-Revenue Water Reduction Programs:
Methodology Analysis using a System Dynamics Approach.**

TABLE OF CONTENTS

ABSTRACT	5
ACKNOWLEDGMENTS	6
1. INTRODUCTION	7
1.1. Outline of this work	9
2. BACKGROUND CONCEPTS AND THEORETICAL FRAME	10
2.1. Background Concepts.....	10
2.1.1. Non-Revenue Water	10
2.2. Non Revenue Water Programs in Colombia	11
2.3. Analysis of Fraud in Non Revenue Water as Illegal Practice	12
2.3.1. Economic Theory of Crime (Becker, 1968).....	13
2.4. Review of previous use of System Dynamics Approaches on Water Companies and its relation with Non Revenue Water Reduction Programs	13
2.4.1. Palermo, Italy	13
2.4.2. City of Leon, México	14
2.5. Previous use of System Dynamics on Loss Reduction Programs (other type of services).....	15
2.5.1. Energy and Power Development Authority in Pakistan.....	15
2.5.2. Energy Utility in Medellín, Colombia (Empresas Públicas de Medellín, EPM)	16
2.6. The use of System Dynamics in other problems involving fraud	18
2.6.1. System Dynamics Discussion Forum (Fraud in Public Transportation).....	18
2.6.2. System Dynamics and the problem of Illegal Logging	19
2.6.3. System Dynamics and Crime in Colombia:	20
2.6.4. System Dynamics and Security	20
2.6.5. Organized Crime and Economic Growth.....	21
2.6.6. Summary.....	21



**Non-Revenue Water Reduction Programs:
Methodology Analysis using a System Dynamics Approach.**

3. PROBLEM DEFINITION AND DYNAMIC HYPOTHESIS	23
3.1. Dynamic Hypothesis and Causal Loop Diagram.....	23
3.1.1. Reference Mode	23
3.1.2. Dynamic Hypothesis and Causal Loop Diagram	26
4. MODEL FORMULATION.....	34
4.1. Model Boundary	34
4.2. Formal Model based on Stock and Flow Diagrams	35
4.2.1. Users Sub System	35
4.2.2. Rational Choice Sub System	39
4.2.3. Reference Value Sub System.....	42
4.2.4. Non Revenue Water Sub System	44
4.2.5. Utility Workers Subsystem	45
4.2.6. Normalization Subsystem	46
4.2.7. Revenues Subsystem.....	48
4.2.8. Credits Collection Subsystem.....	50
5. Model Validation.....	51
5.1. Generalities	51
5.2. Direct structure test.....	52
5.3. Structure oriented behaviour tests	53
5.3.1. Extreme condition tests	53
5.3.2. Sensitivity Analysis	58
5.4. Summary	63
6. POLICY ANALYSIS.....	64
6.1. Varying Non Revenue Water Goals.....	65
6.1.1. Policy 1: Non Revenue Water Goal	67
6.1.2. Policy 2: Delay Time in NRW water Objective: 1 month.....	68
6.1.3. Policy 3: Policy 1 and Policy 2 (Delay=1 month, Goal=8%)....	69
6.1.4. Policy 4: Non Revenue Water Goal=23 %	69
6.2. Policies regarding productivity and efficiency.....	70
6.2.1. Policy 5: Efficiency Improvement.....	72



**Non-Revenue Water Reduction Programs:
Methodology Analysis using a System Dynamics Approach.**

7. CONCLUSIONS.....	75
8. RECOMMENDATIONS AND FUTURE RESEARCH.....	78
9. BIBLIOGRAPHY	79
APPENDIX 1.....	84
MODEL EQUATIONS	84
APPENDIX 2.....	147
DATA COLLECTION	147
APPENDIX 3.....	149
MODEL FILES DESCRIPTION	149



**Non-Revenue Water Reduction Programs:
Methodology Analysis using a System Dynamics Approach.**

ABSTRACT

All across the world there are concerns about water availability that invite utilities to perform better as water stewards. One of the ways to get a better performance, both operational and financial, is to reduce water losses. In fact, the utilities should not just compare water produced to water sold, but they should be aware of the importance of implementing water loss reduction programs as clean water is becoming a scarce resource and conservation is needed. This is why water industries are now recognizing the need to minimize water loss.

The objective of this work is to provide methodological elements to analyse commercial water losses in Colombian Water Utilities based on a system dynamics approach. A model will be developed to study the impacts coming from different policies which are created to reduce water losses (measured by an index called Non Revenue Water¹) in the residential sector.

In the context of this research, the System Dynamics model can ease the understanding of interactions and causal relations underlying the water loss problem among the clients, the company and the surrounding environment. In addition, the model will be used to analyse different policies to investigate the effectiveness of water loss reduction programs in colombian utilities.

Keywords: Non Revenue Water, System Dynamics, Fraud, Water Loss

¹ Non Revenue Water (NRW) is a performance index defined by the International Water Association IWWA
www.iwwa.org



**Non-Revenue Water Reduction Programs:
Methodology Analysis using a System Dynamics Approach.**

ACKNOWLEDGMENTS

I wish to sincerely thank my advisor, Prof. Pål Davidsen, for giving me the opportunity of studying at the University of Bergen. This city has been one of the most beautiful places in the world I know. Also I want to recognize his encouragement, professional guidance and personal advice.

Thanks are extended to Prof. Ana Beatriz Chiquito and Ivar Bleiklie. They were my family in Bergen. Words are not enough to express my gratitude to them.

I am thankful to Eng. Leon Yepes and my former colleagues from Water Utility EPM Bogotá Aguas E.S.P for the interest and support they gave me during my thesis in 2005 and 2006.

Lastly, I would like to thank my parents and close family for their endless love and sacrifice. It has not been easy for them in these last years of my life. They have encouraged me and suffered with all my personal difficulties. Without their support, it would have been impossible to put a final period to this work.



**Non-Revenue Water Reduction Programs:
Methodology Analysis using a System Dynamics Approach.**

1. INTRODUCTION

In these recent years, many countries have redefined the regulations of the public services like water, energy and telecommunications. The old state monopolies were replaced by companies acting within a competitive scenario and governments shifted their role from owners and managers to regulators and supervisors.

Colombia experienced this transition change when the [Law 142 of 1994](#)² established the set of rules of public services, including water supply, wastewater and solid waste. In this new scenario, regulator agencies were created (telecommunications, energy and water) to determine regulations and laws for these services mentioned above.

The Water Sector in Colombia is regulated by the Colombian Water Regulator ([CRA](#))³, which is one of these administrative agencies. Created by the [Ministry of Environment, Housing and Regional Development](#)⁴, its mission is to promote efficiency and sustainable development in water and solid waste services so as to improve the quality of life for the Colombian population.

On the other hand, one of the main objectives of CRA is to prevent the dominant abuses by water companies by controlling the profits using tariff formulas, considering the costs of the companies. The CRA requires that these costs result from an economically efficient operation of the company.

2 Law 142/1994. "Public Domestic Services Law" http://www.cra.gov.co/resources/ley_142.doc

3 Colombian Water Regulatory Commission <http://www.cra.gov.co>

4 Ministry of Environment, Housing and Regional Development. <http://www.minambiente.gov.co>



Non-Revenue Water Reduction Programs:

Methodology Analysis using a System Dynamics Approach.

In order to compel water utilities to become more efficient, The CRA has fixed the maximum admissible level of Non Revenue Water (NRW)⁵ index in 30 % for utilities and municipalities with more than 8000 connections (users)⁶, the level of the company on consideration in this research. The NRW has been included in the cost formula of the tariff. Additional costs caused by NRW values above the admissible level will be not covered via tariffs, and must be absorbed by the companies. Therefore the companies must implement programs in order to improve their efficiency.

The problem addressed in this study deals with the analysis of non-revenue water reduction programs in water companies, specially those existing in countries like Colombia, where water losses reach are dramatically high⁷.

Therefore, a System Dynamics model, focused on the commercial component of NRW (before called Unaccounted-for Water), was made and policies were analyzed. Information and data used in the model were used with permission by [EPM Bogotá Aguas E.S.P](#)⁸ in Bogotá, Colombia.

5 Non Revenue Water is Water distributed by the Utility to households, but not paid. International Water Association. <http://www.iwapublishing.com/pdf/Waterloss-Aug.pdf>

6 CRA 151/2001

7 Domínguez C., Uribe, E. Water Distribution and Sewage System Evolution during the last decade. Andes University. DOCUMENT CEDE 2005-19

ISSN 1657-7191 (Electronic Edition). 2005

8 EPM Bogotá Aguas S.A. E.S.P: Water Company which is one of the firms managing the water distribution system in Bogotá. A description of the whole water system can be found at www.acueducto.com.co. The number of users is almost 1 million, most of them households of low income stratum. EPM Bogotá Aguas www.epmaguas.com



**Non-Revenue Water Reduction Programs:
Methodology Analysis using a System Dynamics Approach.**

1.1. Outline of this work

A system dynamics model will be used to analyze policies for water loss reduction programs in a Colombian Water Utility.

In Chapter 2, theoretical frame which includes Water Losses, fraud behavior and System Dynamics applied to Water Utilities and fraud problems will be described.

Problem definition and dynamic hypothesis underlying the behavior (water losses) and how water utilities deal with this problem, will be proposed and explained in chapter 3.

The model parameterized with information obtained by EPM, will be described in chapter 4. Subsequently, validation and sensitivity analysis will be conducted and documented in chapter 5.

Chapter 6 will concentrate on the subsequent policies for water-loss reduction programs in companies. Policy tests results will be shown in this same chapter as well.

Conclusions and Recommendations will be addressed in Chapter 7 and 8 respectively.



**Non-Revenue Water Reduction Programs:
Methodology Analysis using a System Dynamics Approach.**

2. BACKGROUND CONCEPTS AND THEORETICAL FRAME

As the main objective of this work is the analysis of policies for water loss reduction, background concepts, theoretical frame and past experiences using system dynamics will be taken into account.

2.1. Background Concepts

2.1.1. Non-Revenue Water

Non-Revenue Water (NRW) is the difference between water produced and the amount of water sold to all customers. It is represented with the following formula:

$$NRW = (\textit{produced } m^3 - \textit{Billed } m^3) \times 100 / (\textit{produced } m^3) \quad (1)^9$$

There are two main components of water losses: Technical and commercial. The first of them lies on physical failures on the distribution system (pipe leaks), being some of them easily identified and corrected. High investments in pressure optimization and network renewal are done when dealing with technical losses.

As a result of these investments, most of the benefits come from the lowering of production costs, alleviating a financial pressure for investments on new capacity expansion and saving operational costs.

⁹ International Water Association. <http://www.iwapublishing.com/pdf/Waterloss-Aug.pdf>



Non-Revenue Water Reduction Programs: Methodology Analysis using a System Dynamics Approach.

On the other hand, there is a commercial component that is in part linked to lack of measuring (faulty meters that inaccurately register consumption). This is the water used but not paid.

Moreover, the commercial component of NRW is also associated with illegal connections established by users stealing water or taking it without any legal means to measure it or simply by shifting connections in order to lower consumption measurement. These illegal activities affect water almost all utilities in Colombia; therefore efforts and strategies to deal against this problem should be done by these companies.¹⁰

In Colombia, fraud can easily reach 30 % of NRW. Therefore NRW programs are a primal objective in water companies, and most of these programs are focused in counteracting pilferage and commercial losses. Efforts leading to increase billed water, could yield more than other kind of activities, for example, reducing leaks.

2.2. Non Revenue Water Programs in Colombia

NRW programs have gained importance in water companies in Colombia, which are now concerned on implementing such programs in order to decrease their NRW. Nowadays, NRW index which is in average 50 % at a national level, much higher than the 30 % previously established by

¹⁰ Zuleta F., Montoya, M., Yepes L. "Perdidas Comerciales por conexiones ilegales, un componente primario de las perdidas del agua en los países en desarrollo. El caso Colombiano: Una experiencia replicable" (Commercial Losses by Illegal Users, a primary component of water losses on developing countries. The Colombian Case: A replicable experience). 2004. <http://www.siwi.org> for the Water World Week in Stockholm, August 2004.



Non-Revenue Water Reduction Programs:

Methodology Analysis using a System Dynamics Approach.

Colombian regulations, which is already doubling the world average index (25 %).

Activities carried by Colombian Water Utilities are classified in two categories: Commercial Processes and Technical Processes. Commercial Processes consist of billing and collection processes, suspension and reconnection of users, clandestine and fraud user detection, customer oriented processes and connecting new users to the water network. As mentioned before, fraud detection and control is one of the main activities, as this practice reaches almost 30 % of Non Revenue Water.

On the other hand, Technical processes include Network maintenance and optimization (water pressure control methods), installation and change of meters and leak detection.

Also there is an increasing environmental concern about water overuse for different purposes. Although the used water comes back to rivers or flows, there is a quality loss and normally it comes in form of sewage water, leading to pollute rivers and flows.

2.3. Analysis of Fraud in Non Revenue Water as Illegal Practice

Some components of Non Revenue Water are related with illegal connections which are made by users who intend to have water service without paying it or paying less than they use. This fraud behavior can be explained as a result of decisions made by a rational choice by users, considering perceived costs and benefits in an economic context. Other considerations like moral, social or cultural are not included in this research.



Non-Revenue Water Reduction Programs: Methodology Analysis using a System Dynamics Approach.

2.3.1. Economic Theory of Crime (Becker, 1968)

In 1968, American economist Gary Becker¹¹ studied the causes which lead persons to infringe laws. In his study, crime is driven by rational choices, being benefits and costs perceived by an actor.

It is assumed in this theory that persons do not have moral principles to guide their actions. Therefore, fraud in this case becomes a pure rational choice. For the person who commits fraud, the alternative representing more benefits than costs, will be the more efficient one.

According to this theory, benefits of crime may vary from entirely economical to solely satisfaction. On the other hand, the perceived costs are mainly the fees or punishment and the probability of being caught committing the crime.

2.4. Review of previous use of System Dynamics Approaches on Water Companies and its relation with Non Revenue Water Reduction Programs

2.4.1. Palermo, Italy

Lu (2002), Marrone and Montemaggiore (2004)¹² ¹³ developed a system dynamics application for a water company, [Amap S.P.A](http://www.amapspa.it)¹⁴ in Palermo, Sicily.

11 Becker, G "Crime and Punishment". The Journal of Political Economy. Vol. 76, No. 2. 1968, pp. 169-217

12 Bianchi, C. , and Montemaggiore, G. "Building Dynamic Balanced Scorecards to Enhance Strategy Design and Planning in Public Utilities: Key Findings from a Project in a City Water Company". Revista Dinámica de Sistemas. Vol 2. Num. 2. 2006

13 Lu, G., Marrone, G. , Montemaggiore, G. "Measuring Performance in a Water City Company through a Balanced Scorecard" . Proceedings of the System Dynamics Conference in Palermo. 2002.

14 AMAP S.P.A. Palermo Water Utility. <http://www.amapspa.it>



Non-Revenue Water Reduction Programs:

Methodology Analysis using a System Dynamics Approach.

The resulting system dynamics model was extended into a Dynamic Balanced Scorecard¹⁵ intended to measure performance in different perspectives (process, financial, customer and competitiveness).

The model was validated with historical data between 1995 and 1999. There was a lot of emphasis on the technical component of NRW, being the network renewal the main support for the developed dynamic hypothesis. On the other hand, the collection process was simulated and it was also a leverage point where policies were implemented.

Some of the variables used in this work were related to the capacity expansion in m³, network renewal (time of renewal), water recycle (wastewater treatment for redistribution), human resource for maintenance and suspension.

The AMAP model has been useful in showing processes like credit collection, paying dynamics common to water distribution companies with a system dynamics approach. Moreover, being these processes similar to Water Utilities, they could be replicated and adapted in the context of this research.

2.4.2. City of Leon, México

[Strategic-Clarity](#)¹⁶, a consulting company in Mexico and USA developed a system dynamics application for SAPAL¹⁷ as a tool for policy making.¹⁸ One of the objectives of this work consisted on the integration of different

15 Kaplan and Norton. "Balanced Scorecard, Translating Strategy Into Action" . 1996.

16 Strategic Clarity: American – Mexican Consultant Company based on Mexico and Texas. www.strategic-clarity.com

17 SAPAL: Mexican Water Utility located in Leon, Guanajuato. <http://www.sapal.gov.mx>

18 Membrillo, A., García C., Polo, F., Méndez, A. Enei, E. "Evolution of a Systemic Approach Application for the Management of the Water Supply and Collection System in the City of Leon".2002. Research Papers at www.strategic-clarity.com



Non-Revenue Water Reduction Programs:

Methodology Analysis using a System Dynamics Approach.

methodologies applied before in this company (Total quality management, reengineering, ISO 9000-2001).

The tool also considered a systemic approach, applied along with a balanced scorecard, taking into account concepts like scenario planning and the GRASP Methodology¹⁹.

In this analysis, key indicators for each area on the company were identified, and a SWOT analysis was made to find the leverage points from within the company and outside. The consultant company developed some sub-models, representing the systemic strategies on water supply, payment collection, finances and expansion feasibility, all of them validated with data from SAPAL.

One of the strategies studied in this case was the water losses program, showing some similarities with losses programs in Colombia, because SAPAL is a water utility in a medium-sized city in Latin America, having both commercial and technical components on losses.

2.5. Previous use of System Dynamics on Loss Reduction Programs (other type of services)

2.5.1. Energy and Power Development Authority in Pakistan

Aslaam and Saeed (1995)²⁰ developed a system dynamics model to analyse the dynamics of demand and supply in the energy sector in Pakistan. The

19 Ritchie-Dunham, J. and H. Rabbino. "Managing from Clarity". Chichester: John Wiley & Sons. 2001

20 Aslam, J. and Saeed, K. 1995. Electricity Conservation in Domestic Sector of Pakistan: A System Dynamics Approach. Proceedings of the 1995 International System Dynamics Conference, Tokyo, Japan

Non-Revenue Water Reduction Programs: Methodology Analysis using a System Dynamics Approach.

model also gives hints of the problem of energy fraud and its relation with price and demand. Some of their conclusions are the following:

- Fraud level depends on price level, but not because of the pricing system.
- Pilferage (fraud) control policy is a fundamental change agent in pricing.
- Any conservation program could be not effective in presence of pilferage.

Feedback loops that generate this behaviour are shown in figure 2.1.

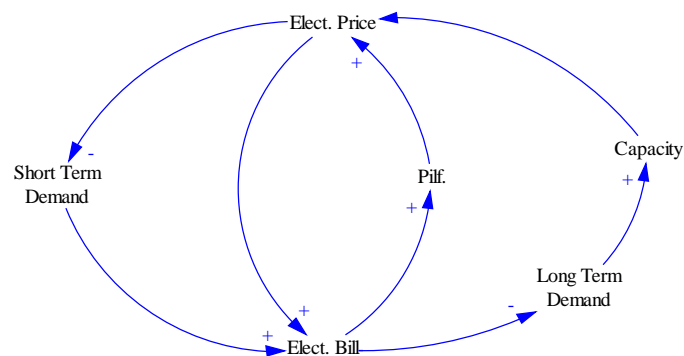

Figure 2.1. Loops Generating pilferage. Aslam and Saeed (1995).

2.5.2. Energy Utility in Medellín, Colombia (Empresas Públicas de Medellín, EPM)

Another work using system dynamics for energy losses was done by Toro (2004)²¹. This work was focused in the commercial component in energy

21 Toro, A. "Una Aproximación Metodológica Basada En Dinámica De Sistemas Para El Análisis De Las Pérdidas No Técnicas De Energía En El Sector Residencial De Una Empresa Electrificadora". Master Thesis. 2004. Universidad Nacional de Colombia. Copies are available on demand at the library of Universidad Nacional.



Non-Revenue Water Reduction Programs: Methodology Analysis using a System Dynamics Approach.

losses for Empresas Públicas de Medellín (EPM)²². The aim of this research was to provide the company with a tool for policy analysis for the losses plans in the company.

As a simplification for modelling purposes, all the commercial losses were considered as frauds. This work is based on a previous study (Aslaam and Saeed, 1995) as a departure point. It has also explained why fraud can be seen as an economic practice with benefits and costs associated with it by following the Theory of Crime by Becker (1968)²³.

The model was validated with data from the company from 1998 to 2004, and it was possible to analyse policies for lowering commercial losses. Policies were related to tariff, fees, action efficacy, etc. The simplified model is shown in figure 2.2

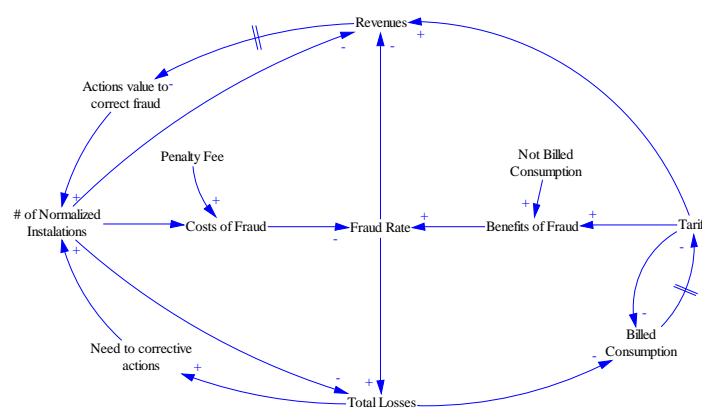

Figure 2.2 Simplified Model of non technical losses. Toro (2004).

22 EPM: Empresas Públicas de Medellín. Water, Energy and Telecommunications Utility in Medellín, Colombia. <http://www.eppm.com>

23 Becker, G. Crime and Punishment. The Journal of Political Economy. Vol. 76, No. 2. 1968, pp. 169-217



Some concepts of both models (Aslaam-Saeed and Toro) were replicated in this research, although the theoretical frame and specific conditions of the problem are quite different.

2.6. The use of System Dynamics in other problems involving fraud

Fraud problem has been studied and analyzed using System Dynamics. Although problems and systems may differ, there are common elements that can be used in this research. Elements like "willingness to commit fraud", or "inspection", among others, will be used in the model. Some models working on fraud topics are the following:

2.6.1. System Dynamics Discussion Forum (Fraud in Public Transportation)

From the System Dynamics Discussion Forum, provided by Vensim, a discussion about fraud can be found. Related to this post, there is a simulation model (Laublé, J.J., 2005)²⁴. This model is available for downloading from Vensim.co.uk.

The model was focused on fraud in public transportation, but it has elements in common with the fraud problem in public services: free-riders and inspectors who deal against free-riding. Here free-riders in public transportation can be seen as fraudulent users in other kinds of services because they obtain benefits from the service without paying it.

The stock and flow diagram of this model is shown in figure 2.3.

²⁴ <http://www.ventanasystems.co.uk/forum/viewthread.php?tid=2564>



Non-Revenue Water Reduction Programs:

Methodology Analysis using a System Dynamics Approach.

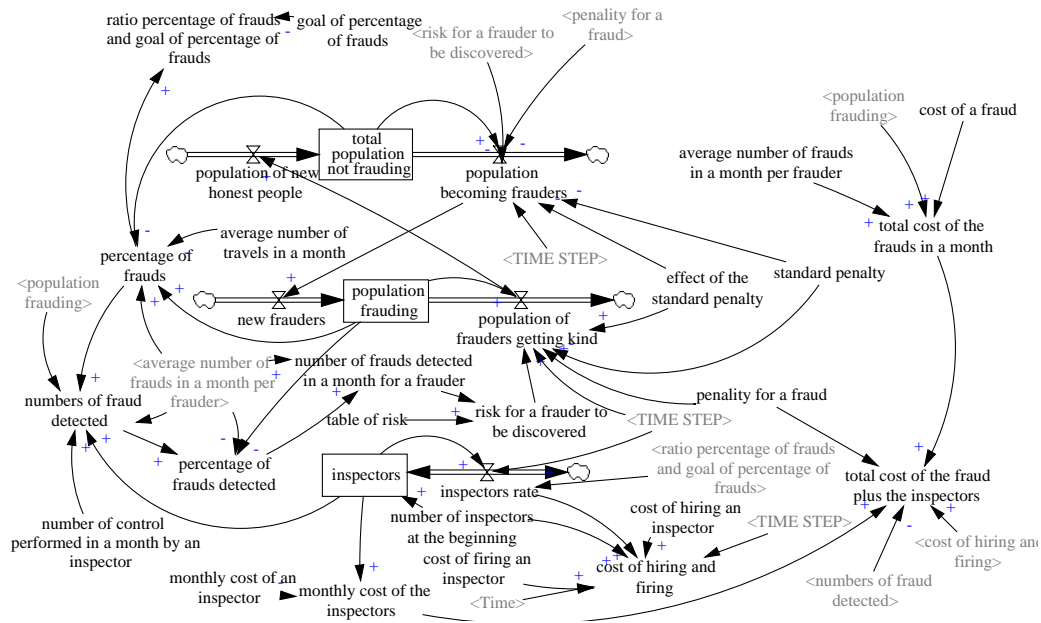

Figure 2.3. Model of Fraud in Public Transportation. Laublé (2005).

2.6.2. System Dynamics and the problem of Illegal Logging

The problem of illegal logging on the forest areas in Indonesia has been analysed using a System Dynamics approach (Dudley, 2004)²⁵. Here, the willingness in doing illegal practices (work on illegal logging) by the people outside and inside a community in Indonesia is addressed in the model.

In this research, willingness is described as the tendency of committing this kind of crime, which is affected both by the perceived benefits and costs.

In this work, the community control and support (Social Capital) is one of the main causes determining the willingness of the villagers to do illegal logging.

²⁵ Dudley, R. "A System Dynamics Examination of the Willingness of Villagers to Engage in Illegal Logging" *Journal of Sustainable Forestry*, Volume 19. PP 31-53 (22) . 2004



Non-Revenue Water Reduction Programs:

Methodology Analysis using a System Dynamics Approach.

2.6.3. System Dynamics and Crime in Colombia:

The criminality problem in Colombia is addressed by a System Dynamics Approach (Hernandez and Dyner, 2001²⁶; Jaen and Dyner, 2005²⁷).

The model incorporates assumptions based on the Crime Theory (Becker), learning (delinquency) and Social Capital construction and erosion; and explains the causes of this criminality behaviour in the past and proposes policies for lowering and preventing actual and future criminality.

2.6.4. System Dynamics and Security

A team conformed by the University of Albany²⁸ (New York), University of Agder²⁹ (Norway) , University of Navarra (Spain), Cert Software Engineering Institute at Carnegie Mellon University (USA), and Sandia National Laboratories (USA), studied the security issues (internal and external threats on technology organizations) using a system dynamics approach. Available documentation can be found at the 2005 proceedings at the System Dynamics Society^{30 31}.

26 J. Hernández, J. and Dyner, I. "Crisis in Colombian Prisons: Cause or Consequence of a Flawed Judicial System". Conference Proceedings of The 19th (2001) International Conference of the System Dynamics Society (Atlanta, Georgia) 2001

27 Jaen, J. And Dyner, I. "Espirales de la Violencia" (Spirals of Violence) . Revista Dinámica de Sistemas Vol 1. Num 1. 2005

28 www.albany.edu

29 www.uia.no

30 Rich, E., Martinez, I., Conrad, S., Cappelli, D., Moore, A., Shimeall, T., Andersen, D., Gonzalez, J., Ellison, R., Lipson, H., Mundie, D., Sarriegui, J., Sawicka, A., Stewart, T., Torres, J., Weaver, E., Wiik, J. "Simulating Insider Cyber-Threat Risks, a Model-Based Case and a Case-Based Model". Conference Proceedings of The 23th (2005) International Conference of the System Dynamics Society. 2005

31 Wiik, J and Gonzalez, J. "Limits to Effectiveness in Computer Incident Response Teams" . Conference Proceedings of The 23th (2005) International Conference of the System Dynamics Society. 2005



Non-Revenue Water Reduction Programs:

Methodology Analysis using a System Dynamics Approach.

The motivation of this research was the increasing vulnerability of companies to internal and external attacks coming from different actors (from employees to hackers), and how this vulnerability depends on technical and behavioural controls. And like the other problems (crime, fraud, etc), there are two main actors: the attacker, having motivations based on rational and social choices, and the company, defending against these attacks by several means.

The activities the company normally implements can vary from technology improvement to corrective actions in order to discourage attackers.

2.6.5. Organized Crime and Economic Growth

Raimondi³² developed a system dynamics model to support policy decisions and macroeconomic strategies in order to reduce crime and promote economic growth in a country.

Concepts like "risk fraction" (unemployed people being the recruitment base for crime organizations) and "crime attractiveness" (willingness to commit crime) were studied in this research, and they were used in the model of this thesis.

2.6.6. Summary

System dynamics models working on fraud issues have in common one element: rational choice of the people who steal or commit fraud (risks to be discovered, feasibility of fraud, benefits and costs of these illegal practices), which fits into the Crime Theory.

32 Raimondi, V. "Organized Crime and Economic Growth". Proceedings of the 2001 System Dynamics Conference.



Non-Revenue Water Reduction Programs:

Methodology Analysis using a System Dynamics Approach.

By using system dynamics, the nature of this problem in utilities can be explained, not only from the solely economical point of view but also stating why fraud is influenced by other different mechanisms, which is one of the objectives of this work.



**Non-Revenue Water Reduction Programs:
Methodology Analysis using a System Dynamics Approach.**

3. PROBLEM DEFINITION AND DYNAMIC HYPOTHESIS

3.1. Dynamic Hypothesis and Causal Loop Diagram

As outcome of this work, it is aimed to provide a tool to analyse Non-Revenue Water programs in Colombian water utilities, but also to propose policies leading to improve their performance in terms of reducing commercial losses.

For this reason, some key aspects of the company performance were deeply analysed with the intention that inefficiencies leading to a high water loss index could be identified and reduced by policies.

3.1.1. Reference Mode

As explained before, a high Non-Revenue Water index in the water distribution process appeared as one of the main inefficiencies in water utilities in Colombia. This high loss rate has been normally above the admissible level fixed (30%) by the Regulatory Commission CRA, so that utilities having losses above this maximum permissible level should assume the costs of these losses. In other words, these costs cannot be paid via tariffs by final users.

In the following graph, the behaviour of Non-Revenue Water for the south part of Bogotá, Colombia³³ is shown:

33 Data provided by EPM Bogotá. This Water Utility is in charge of the technical and commercial management of the Water Distribution System in two big zones in Bogotá. Each zone has approximately 500.000 users.



Non-Revenue Water Reduction Programs: Methodology Analysis using a System Dynamics Approach.

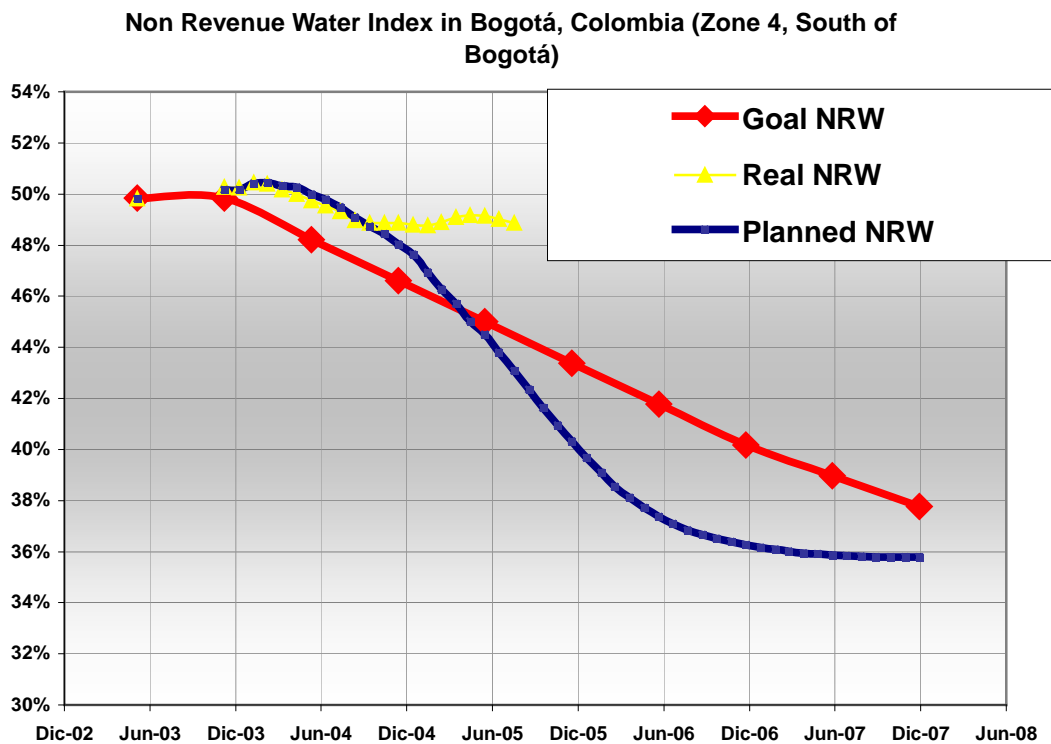

Figure 3.1 Non Revenue Water Index in Bogotá (Zone 4, corresponding to c.a 500.000 users, located at the south of the city). Data provided by EPM Bogotá.

The graph shows the Non-Revenue Water Index behavior from June 2003 to December 2007 (projected). Here, the Water Utility has a goal in order to reduce water losses (red line). In order to improve the planning process, the company has also a moving goal, represented by a blue color in this graph, each 12 months, depending how far are the real losses, drawn in yellow, from the fixed goal in red.

Also there is another moving goal, given each six months, in order to adjust quickly to the real NRW, as it is shown in figure 3.2.



Non-Revenue Water Reduction Programs: Methodology Analysis using a System Dynamics Approach.

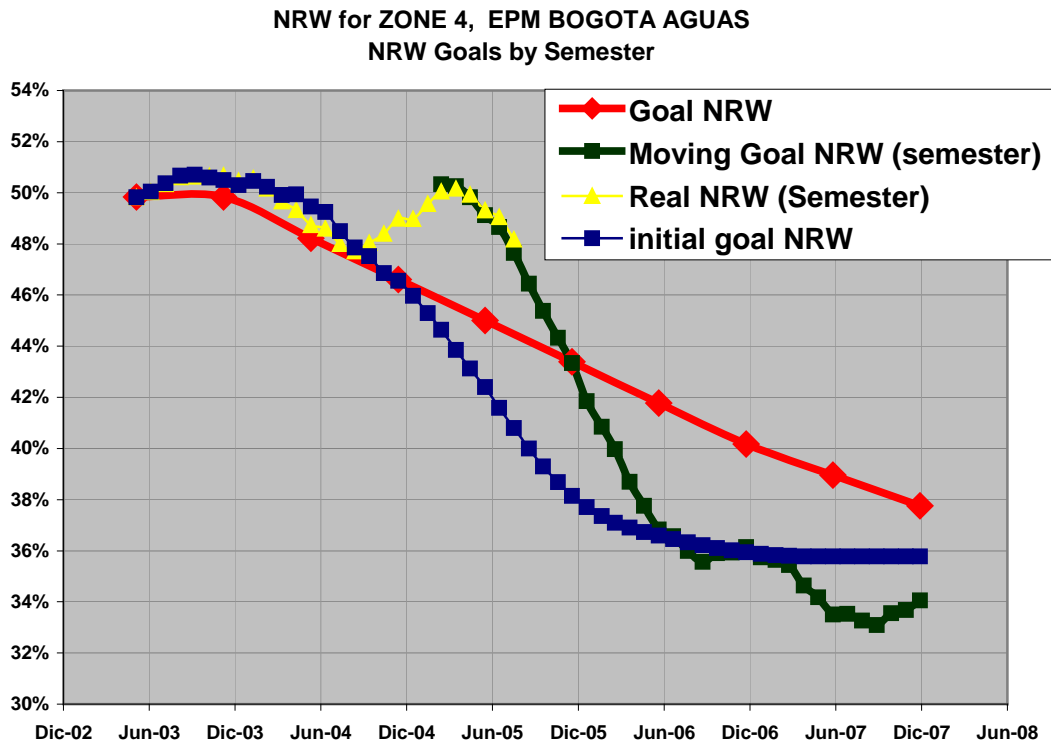

Figure 3.2. Non Revenue Water Index in Bogotá by semester. (Zone 4, corresponding to c.a. 500.000 users, located at the south of the city). Data provided by EPM Bogotá.

Here, the real NRW index increased during years 2004 and 2005, despite all efforts made in the company, most of them technical (lowering water pressure, replacing valves and pipelines to reduce leakage)³⁴. In July 2005, a complete NRW program which also included commercial losses was implemented finally in the company³⁵.

As mentioned before, water losses in NRW index, are differentiated in two: Technical losses and Commercial Losses. Indeed, commercial losses in Bogotá³⁶ commercial losses reach almost 50 % of NRW. In order to simplificate this analysis, only commercial losses were taken into account.

34 EPM Bogotá Aguas. Water Losses Control Program. December 2005.

35 EPM Bogotá Aguas. Commercial Losses Plan. July 2005.

36 Water Loss Reduction Project and Regulatory Framework Reform. Final Document. CRA 2007. www.cra.gov.co



Non-Revenue Water Reduction Programs:

Methodology Analysis using a System Dynamics Approach.

Therefore, the NRW in this thesis reflects only commercial losses (50 % of NRW), and it was assumed that the admissible NRW index is 15 % (half of what the Regulator has fixed in the tariff formula).

3.1.2. Dynamic Hypothesis and Causal Loop Diagram

In chapter 2, definition of Non Revenue Water was explained, and it followed the formula: $NRW = (produced\ m^3 - Billed\ m^3) \times 100 / (produced\ m^3)$. In words, it is the difference between produced water and billed water, compared to the produced water which is distributed to final users³⁷.

Both volumes depend directly by the number of users, because their dynamics will determine the final system behaviour, which is reflected in the Non-Revenue Water Index.

Indeed, water losses are related to the number of fraudulent users, assuming technical losses as controlled. These losses result from multiplying illegal consumption (not billed consumption) by the number of these fraudulent users.

Normal users (honest users who do not steal water) can be determined as the difference between total users and fraudulent users, although this difference is somehow estimated, due to the difficulty on finding some fraudulent users.

However, total number of users, paying users (fraudulent and honest), suspended users (non paying users which have the service cut-off) and

³⁷ In this research, the users are not being discriminated in sectors, although it is desirable to do so because water demand patterns are different between types of users. The type of users mostly found in Zone 4 in Bogotá are residential users. For the sake of simplicity, all users are treated like residential ones.



Non-Revenue Water Reduction Programs: Methodology Analysis using a System Dynamics Approach.

clandestine users (the ones without a contract with the company) are data which can be obtained at the utility.

Having the number of normal and fraudulent users, it can be possible to calculate all the billed water, supposing average billed consumptions. When the number of fraudulent users increases, having the total users as a fixed number, the billed consumption decreases, because billed consumption in fraudulent users can be lower than consumption in normal users.

User dynamics, Billed consumption and Non Revenue Water index is shown in Figure 3.3.

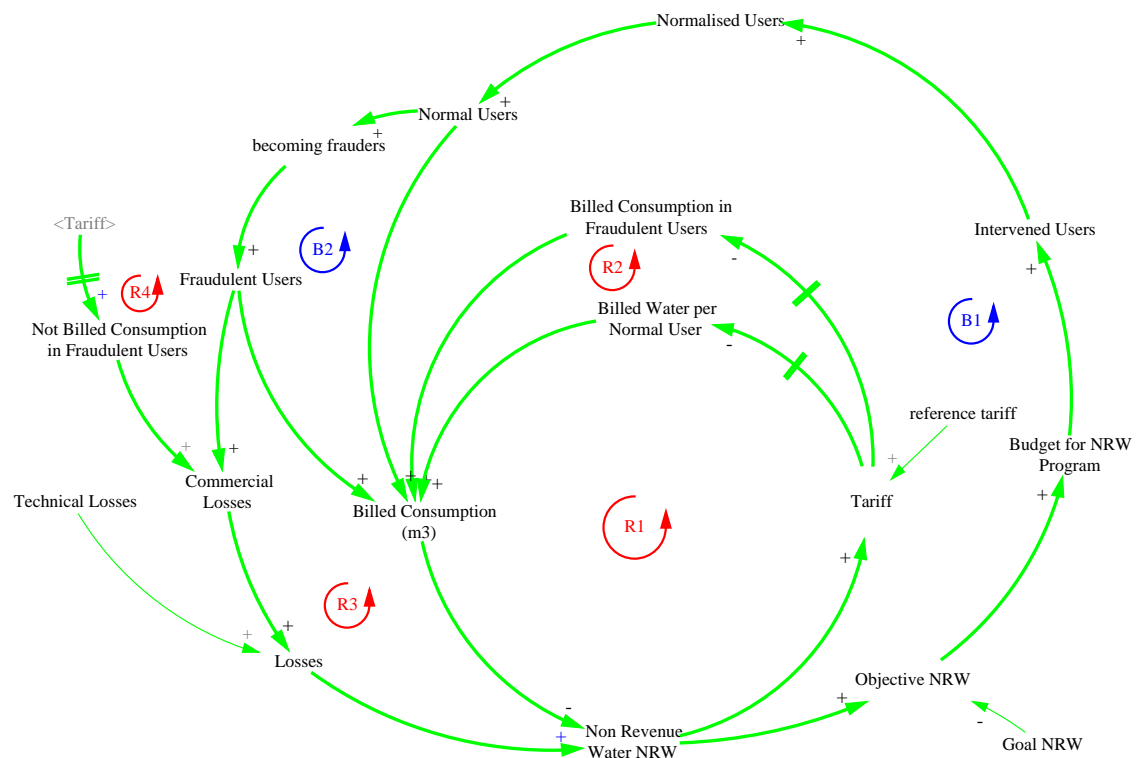

Figure 3.3. Users chain from paying people to ones with expired contract

The diagram shows how commercial losses are caused by fraudulent users (loops R3 and R4), assuming they consume a certain amount of water



Non-Revenue Water Reduction Programs:

Methodology Analysis using a System Dynamics Approach.

without paying for it. Some of these fraudulent users do pay for water as well (loop B2), but only the users that are receiving water service, because they are paying on time. Loops R1 and R2 show how tariff depends of NRW index, but also show that water demand can vary due to tariff changes.

Although water demand is believed to be inelastic, there can be changes in demand patterns if tariff increases. These changes are also evident with tariff reductions. Also illegal demand can change due to price variations (loop R4).

As mentioned before, not all fraudulent users pay for part of the water they consume. There are users, already suspended, tampering water by illegal means with the consequence of not paying for the service (billed consumption is zero). This is the same case for users who do not have a contract with the company. Here fraudulent consumption for suspended and clandestine people is assumed the same, although there could be a different perception to be caught and punished in these two fraudulent users (suspended and clandestine).

There is a need to differentiate users, not only by their behavior (honest and fraudulent), but also by their payment status. A fraction of the served population pay the bills for how much water they consume. But, when bills cannot be paid on time, they should be paid in the second month for all the consumption (two periods) before suspending service.

After service suspension, some of the users will try to pay all debts in order to being reconnected, but also there are users willing to take the service at any cost, with the consequence of committing fraud, and as explained before, there will be greater losses due to these suspended users and expired contract users.



Non-Revenue Water Reduction Programs:

Methodology Analysis using a System Dynamics Approach.

Suspended users who do not pay will be out of the service contract between them and the utility (the formal contract which provides water as a service). Some of them remain honest without taking water from the system, but they are others who begin stealing water.

Most of the NRW by fraud comes from suspended users and clandestine users (without any contract with the Water Utility), because the reported consumption is zero, but they are still consuming water. They would be willing to stop tampering water if they are persuaded by inspection policies or if the company gives them financial options to pay their debts and fees.

It is expected that the number of fraudulent users will decrease, due to more control and normalization of these users. Interviews and datasheets in EPM have showed that fraud inspection was more intensive in suspended and expired users than in paying users.

Normalized users are those who were found fraudulent when were first intervened (visited by inspectors). In other words, normalization comprises processes like user selection which departs from identifying them, analysing their historical consumptions, payments, and depending of income levels and payment status (in time, paying late, suspended or out of the contract).

After intervention and normalization, actions (implementing fees, revision, technical) are implemented for turning frauders to normal users. Though some intervened users were normalized, there are others in which normalization could not be done. As a result, the number of normalized users is normally less than the number of interviened ones, so an Index between 0 and 1, represents efficiency in terms of normalization and intervention in users. This competence can be improved by experience and training in these users.



Non-Revenue Water Reduction Programs: Methodology Analysis using a System Dynamics Approach.

Sometimes it is difficult to find a user committing fraud at the moment of inspection, to carry on normalization. Even if the company suspects a fraud, if it is not discovered when doing inspection or they do not have legal proofs of the fraud, the company cannot to force this user to pay and be normalized. This affects the efficiency index mentioned above.

Benefits perceived by fraudulent users are proportional to the stolen water volume (not billed consumption), being tariff the same (for the sake of simplicity, reference tariff is taken in this model as fixed, but the truth is that tariff is affected by Non-Revenue Water index).

On the other hand, frauders will perceive costs related to probability of being caught and fees for stealing water. The diagram in Figure 3.4. shows the willingness to committ fraud, namely "fraud attractiveness" which is the ratio of these pereceived benefits and costs.

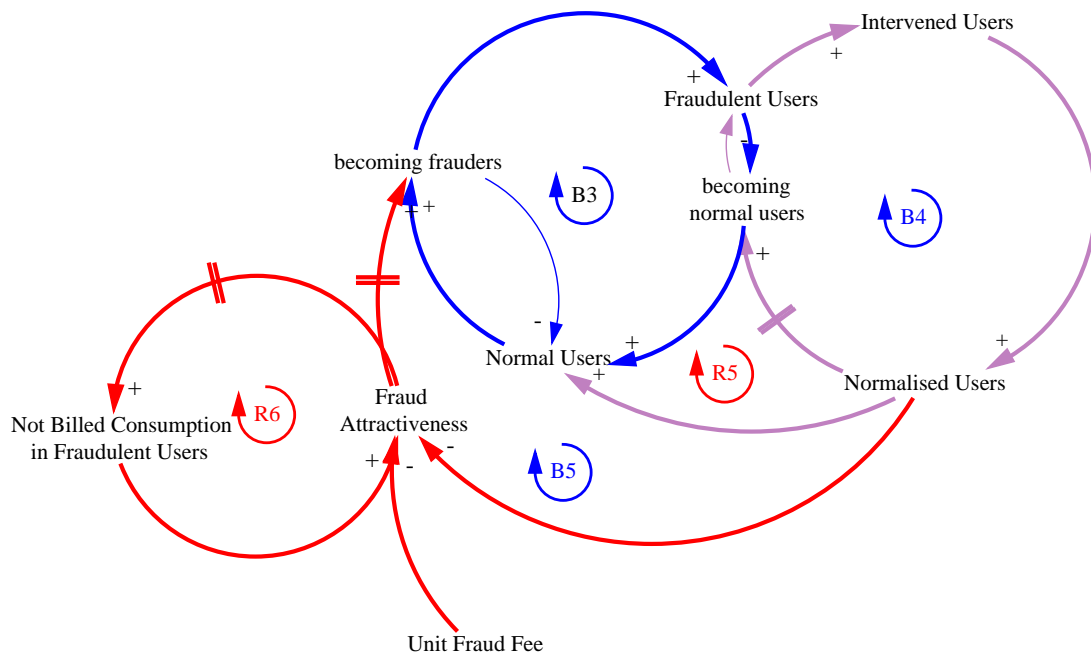

Figure 3.4. Fraud Attractiveness and Users



Non-Revenue Water Reduction Programs: Methodology Analysis using a System Dynamics Approach.

Loops B4 and B5 show how users become honest or fraud by Inspection and Normalization. Normalization not only has an instant consequence (i.e. users becoming normal), but also it influences other fraudulent users to become normal (loops B4 and R5). Also loop B5 shows how attractiveness to commit fraud decreases as normalized users increase, while loop R6 shows how illegal demand can be elastic due to attractiveness. Although relation between illegal water demand and attractiveness is mentioned here, the model will not consider this effect since there was lack of information in this matter.

Other assumptions:

Other assumptions were taken from Amap experience, where a system dynamics model was done. These assumptions can be applied in the context of this thesis, being the following taken as the most relevant to this work:

When users pay, they always do so for all the bills, including previous arrears. It implies that one person cannot stay at the same time in more than one of the stocks that represent the people groups differentiated by their payment. This applies both to honest and fraudulent users.³⁸

People must pay within a limited time, after receiving the notice, to avoid suspension. Sometimes, due to limitations of information systems, the suspension list cannot be updated in time and the service will be suspended even if they pay before the final date. Therefore it is assumed that there is no payment from users on the suspension list.

³⁸ Lu, Gefei." M.Phil Thesis in System Dynamics. 2002. University of Bergen, Norway.

Non-Revenue Water Reduction Programs: Methodology Analysis using a System Dynamics Approach.

The notices of service suspension are sent out immediately when the normal payment time is due (2 months).

Using an existing causal loop diagram from Lu (2002)³⁹, dynamics of users from paying users to expired contracts users is shown in figure 3.5.

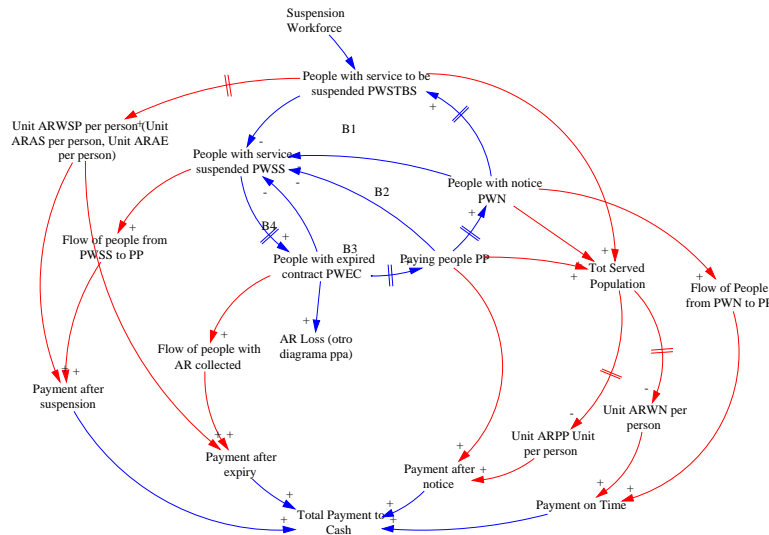

Figure 3.5. Users chain from paying people to ones with expired contract

Finally, Dynamics of users and their willingness to take water illegally can be represented as it is shown in figure 3.6. For the sake of simplicity, this diagram does not include the users chain from paying users to expired contracts users which was shown in Figure 3.5.

³⁹ Lu, Gefei." M.Phil Thesis in System Dynamics. 2002. University of Bergen, Norway.



Non-Revenue Water Reduction Programs: Methodology Analysis using a System Dynamics Approach.

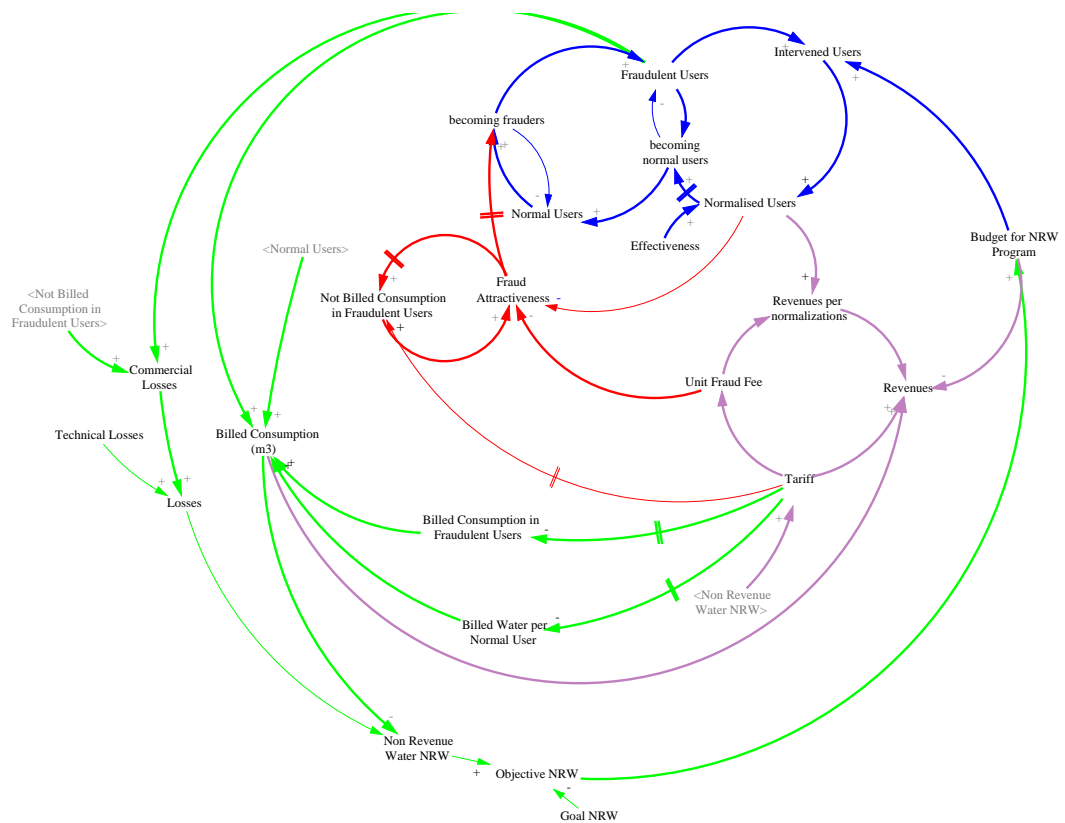

Figure 3.6. Causal Loop Diagram showing User Dynamics, NRW, Billed and Not Billed Water, Inspection and Normalization.



**Non-Revenue Water Reduction Programs:
Methodology Analysis using a System Dynamics Approach.**

4. MODEL FORMULATION

In the following paragraphs, the structure of the model used to analyse the water loss problem in utilities will be described. In particular, an overview of the main sectors constituting the examined system and a short explanation of some of the model equations are given in this chapter.

4.1. Model Boundary

Before focusing on the model formulation, a table showing the model boundary is presented in Figure 4.1. This table gives an overview of what is and is not included in the model.

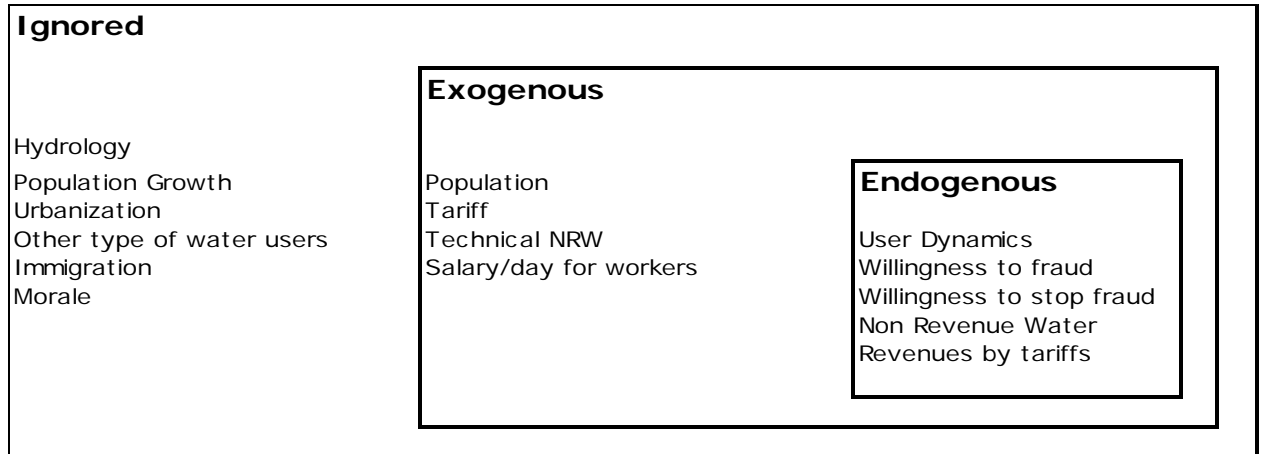

Figure 4.1 Model Boundary Diagram

Although this diagram is somehow limited, it is useful in providing a raw explanation about the model's position in a particular domain, where in the



Non-Revenue Water Reduction Programs:

Methodology Analysis using a System Dynamics Approach.

context of this research, would be the dynamics of fraud and the utility dynamics (inspection).

4.2. Formal Model based on Stock and Flow Diagrams

Model boundary charts show an idea of the architecture of the model, but fail to describe how variables are related. The use of diagrams showing stock and flow structures is useful for describing the feedback structure, which it was also explained previously on chapter 3.

In addition, causal connections can be seen in detail by examining each sector using simple stock and flow diagrams, showing not only the overall architecture of the model, but also the flows of material, information and others.

To see each sector in detail, there will be an explanation of these sectors, focusing on their underlying dynamics.

4.2.1. Users Sub System

Users can be categorized according to their payment status. Also the model makes difference between normal users (honest users) and fraudulent users.

As a consequence, two chains, one for normal users and the other for fraudulents, are created. There are also flows between these two kind of users, in different stages of this payment chain.

Dynamics of these users and their payment status can be explained as follows: Normal Users will move from Paying Users to Delayed Paying Users



Non-Revenue Water Reduction Programs:

Methodology Analysis using a System Dynamics Approach.

when they cannot pay on time (2 months). After this period, the company will suspend the service (Suspended Users). Suspended Users can turn into Expired Users when debt is very high and there is no payment, or when user is no longer in the company database (see figure 4.3). Both Delayed Paying Users, Suspended and Expired can go to Normal Users when they pay their bills and are reconnected.

On the other hand, fraudulent users will go from paying users (they pay on time, but they do not pay for all the water they consume), to delayed users. In this case, they turn into normal suspended because suspension works also can help to correct irregularities (fraud). When users are suspended, they can start taking water illegally, turning into Fraud Suspended Users.

Finally, if they do not pay their debts, the utility will cease the water contract, turning them into Expired Contract Users. As suspended users can do, a fraction of these expired users will turn into Clandestine users, consuming water but not paying for the service.

Non-Revenue Water Reduction Programs: Methodology Analysis using a System Dynamics Approach.

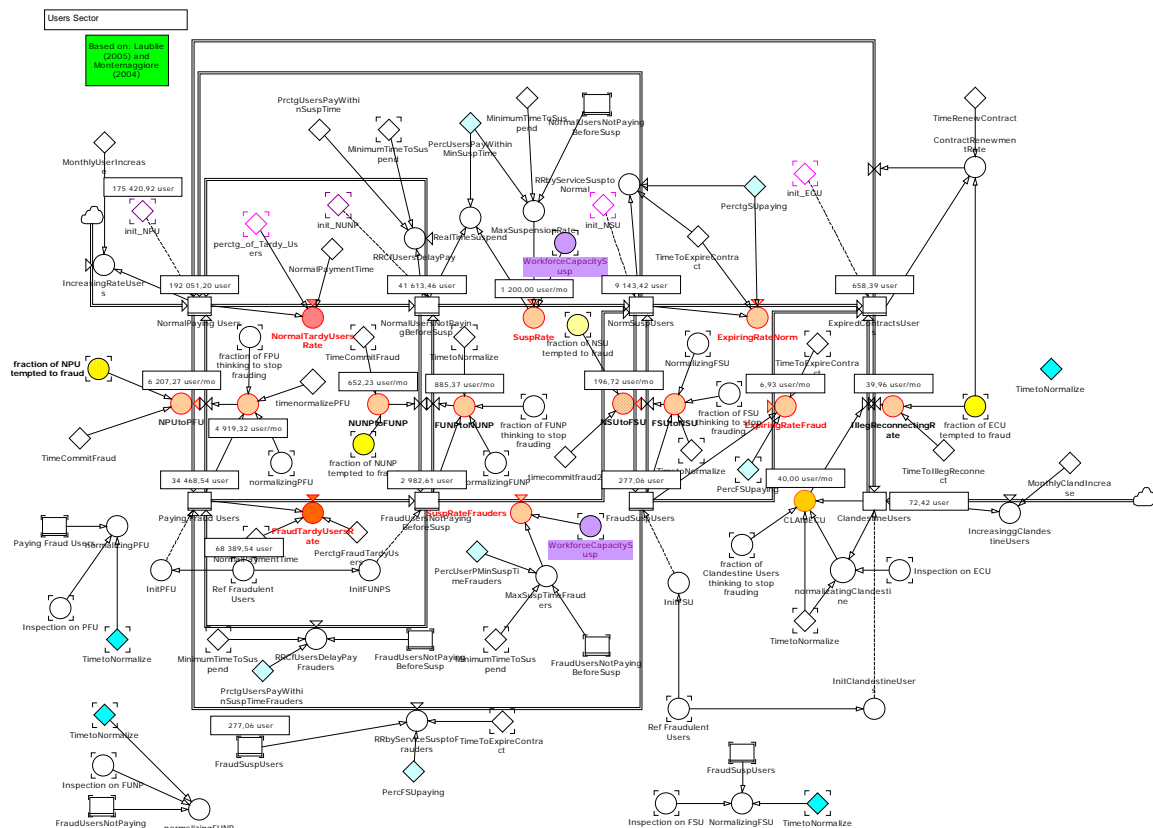

Figure 4.3. Users Subsystem

There are flows going from normal users to fraud users, following this equation:

$$NPU \text{ to } FPU = \text{'fraction of NPU tempted to fraud'}/\text{TimeCommitFraud}$$

NPU= Normal Paying Users

FPU= Normal Fraudulent Users

Units: user/month

Fraction of NPU tempted to fraud: the people willing to committ fraud after evaluating fraud costs and benefits

The names of these flows changes depend of what type of honest or normal user is in the paying chain (paying, delayed, suspended or expired):



Non-Revenue Water Reduction Programs:

Methodology Analysis using a System Dynamics Approach.

On the other hand, the flow from fraudulent to honest users can be represented by:

$$FPU \text{ to } NPU = IF('Paying Fraud Users' > 0 <<user>>; 'fraction of FPU thinking to stop frauding' / \text{time normalize PFU} + 'Inspection on PFU'; 0 <<user/mo>>)$$

Fraudulent users turn to honest either by deciding to stop or by inspection. They decide to stop if they do not see the act of committing fraud as valuable. In other words, the users could perceive high risks to be discovered because of inspection. Also fees can persuade users to stop frauding. Inspection, discovering, and normalizing users is the other way to turn fraudulent users to normal and honest ones.

These two flows (users going from honest to fraudulent) are shown in figure 4.4.

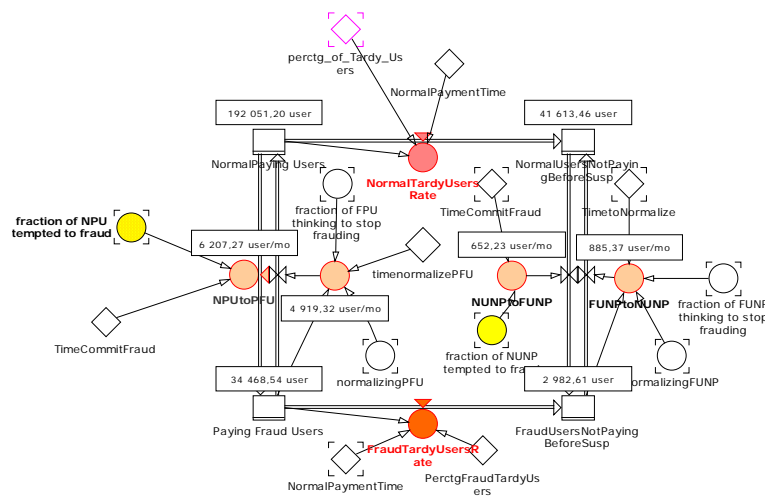

Figure 4.4. Flows from Honest to Fraudulents and Fraudulents to Honest in Paying Users and Delayed Paying Users



Non-Revenue Water Reduction Programs: Methodology Analysis using a System Dynamics Approach.

4.2.2. Rational Choice Sub System

The assumption of rational choices on how users behave is taken into account in this model. The willingness to commit fraud (i.e. to connect illegally or take water for free) depends on how they perceive benefits and costs related with pilferage. *Fraud attractiveness* is the ratio between perceived costs of committing fraud, associated with fees and risk to be discovered, and benefits which are "saving" money for not paying tariffs or paying less for the service.

Fraud attractiveness has an effect on the fraction of people tempted to choose fraud: when attractiveness is high, the more people will be willing to commit fraud. Also it has an effect on the people to stop committing fraud. When they perceive low attractiveness, they would be more willing to stop stealing water and be honest.

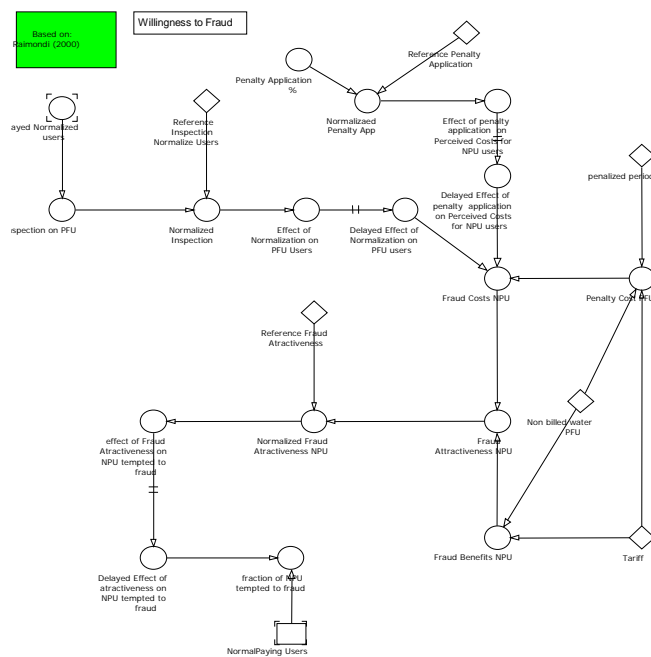



Non-Revenue Water Reduction Programs: Methodology Analysis using a System Dynamics Approach.

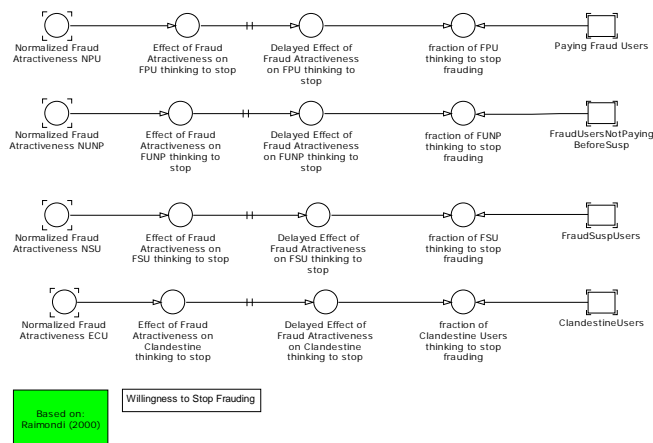

Figure 4.5. Rational Choice Subsystem

$$\text{Fraud Attractiveness} = \text{'Fraud Benefits NPU'} / \text{'Perceived Fraud Costs NPU'}$$

Unit: dimensionless

$$\text{Perceived Fraud Costs NPU} = \text{'Penalty Cost PFU'} * \text{'Effect of Normalization on PFU Users'} * \text{'Effect of penalty application on Perceived Costs for NPU users'}$$

Units: \$/mo/user

$$\text{Fraud Benefits NPU} = (\text{'Non billed water PFU'} * \text{'Tariff'})$$

Units: \$/mo/user

Non Billed Water PFU is the stolen or loss water taken by a fraudulent user, in this case, a Paying Fraudulent User, who is a kind of user who pays on time, but also takes water without paying. The more water the user can steal, the more benefits are perceived by this illegal practice.

The tariff also is seen as a potential benefit. When tariff increases, the perceived benefits are higher. But tariff can influence the user choice, by increasing perceived costs.⁴⁰

The effect of Fraud Attractiveness to commit fraud was made as a table function, as Figure 4.6. shows.

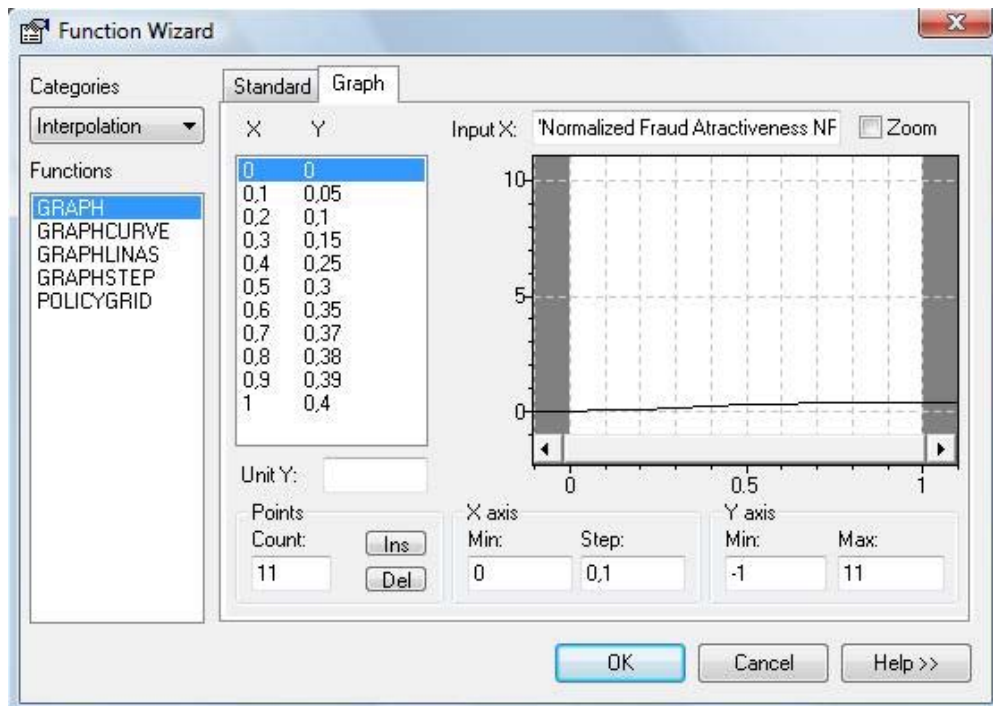

Figure 4.6. Effect of Fraud Attractiveness in Users Willing to Commit Fraud

Also fraud attractiveness has an effect on fraudulent people to stop stealing water. This effect is also a table function⁴¹.

⁴⁰ According to EPM, there has been a flaw on what should be the fee which is paid by the fraudulent user. Also the volume of water to charge the user has been discussed. The Regulator is on the way of creating a resolution in order to provide the company with a legal ground to struggle against these illegal practices. Here, it is assumed that tariff will be the same tariff for the normal use of water, but can be higher in order to persuade fraudulent users.

⁴¹ It is not easy to find a function which represents the willingness to commit fraud and the willingness to be honest. Moreover, water is a vital resource, and depending which user is, the effects will be different: it is not the same when the user has already the service because is paying and when the user is suspended or expired. These two lasts

**Non-Revenue Water Reduction Programs:
Methodology Analysis using a System Dynamics Approach.**

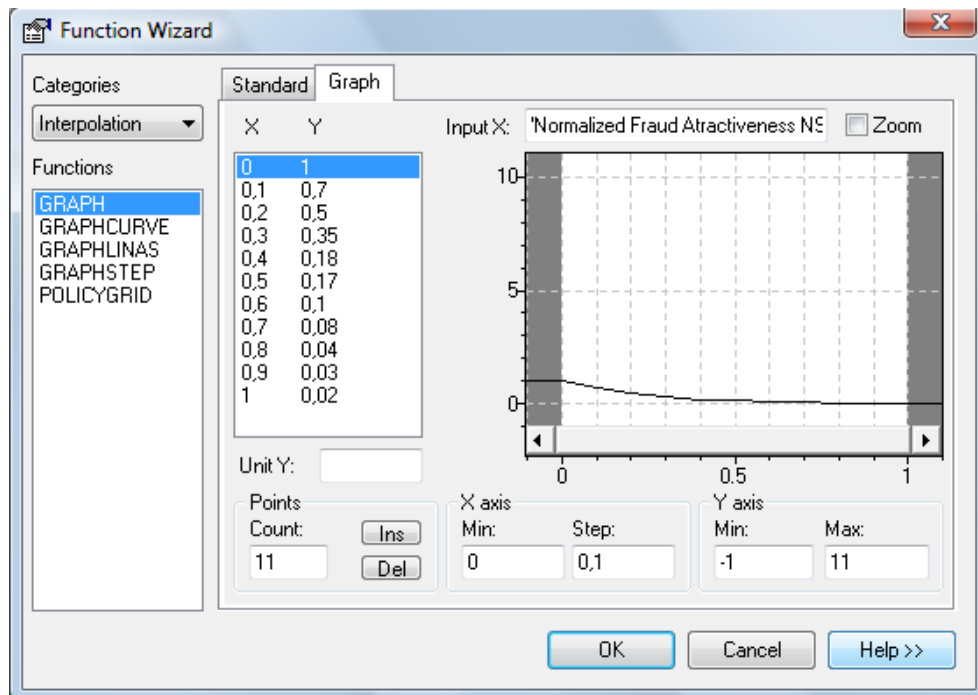

Figure 4.7. Effect of Fraud Attractiveness in Users Willing to stop committing fraud

4.2.3. Reference Value Sub System

Inputs in this model are the reference values at the first month of the simulation. This part has been replicated from the model made by Toro.

are more willing to steal because they need water. For that reason, table functions were used to describe a relation between attractiveness and willingness to commit fraud and willingness to be honest.



Non-Revenue Water Reduction Programs: Methodology Analysis using a System Dynamics Approach.

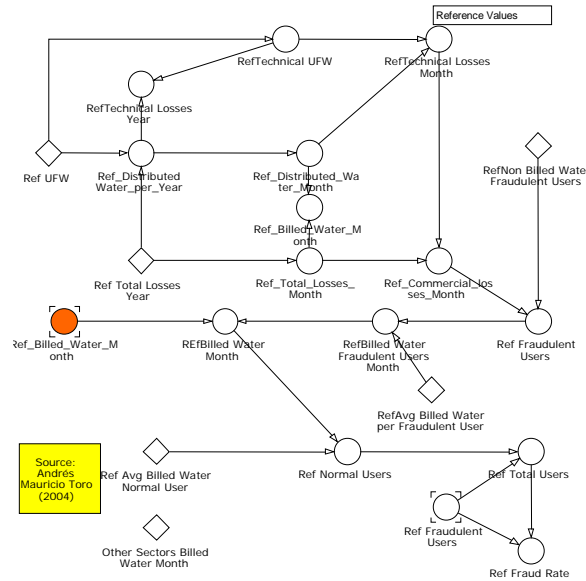

Figure 4.8. Reference Values Subsystem

This subsector works with data taken from the Water Company, which is listed on table 4.2.

Parameter	Description	Value
Ref UFW	Reference Non Revenue Water	23,08 %
Ref Losses Year	Reference Water Losses per Year (m ³ /yr)	21.747.873,5
RefNonBilledWaterFraudulent Users	Not Billed Water in Fraudulent Users (m ³ /month/user)	26,5
RefBilledWaterFraudulentUsers	Billed Water in Fraudulent Users (m ³ /month/user)	15
RefBilledWaterNormalUsers	Billed Water in Normal Users (m ³ /month/user)	25

Table 4.2. Reference Values

Also it is assumed that 70 % of fraudulents pay for the service (paying fraudulent users and delayed paying fraudulent users). The other 30 % is distributed between suspended fraudulent users and clandestine users.



Non-Revenue Water Reduction Programs: Methodology Analysis using a System Dynamics Approach.

4.2.4. Non Revenue Water Sub System

This subsystem, based on the model made by Toro, uses the reference values described in 4.2.3. to calculate the amount of *billed water*, both by Fraud Paying Users and Normal Users (honest). Subsequently, the amount of distributed water is calculated as the sum of billed water, plus water losses.

Unaccounted-for water (now called "Non Revenue Water") is the ratio between Water Losses and Distributed Water, which is compared to the *Non Revenue Water Goal* in the company. The difference between the goal and the simulated NRW is represented by the variable "*objUFW*"⁴². This variable is the objective the company tries to reach monthly.

There is an information delay which reflects the "floating goal" described in chapter 3, which takes into account the original goal (Non Revenue Water Goal) and the actual Non Revenue Water.

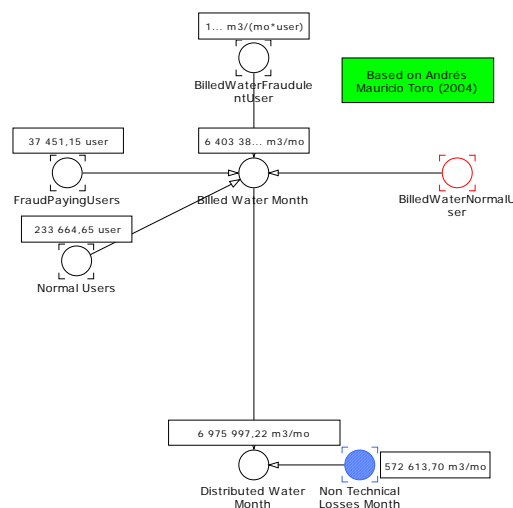

⁴² "UFW" is the acronym of "Unaccounted-For Water" which is the term used for water losses. Nowadays "Non Revenue Water" is widely used.



Non-Revenue Water Reduction Programs: Methodology Analysis using a System Dynamics Approach.

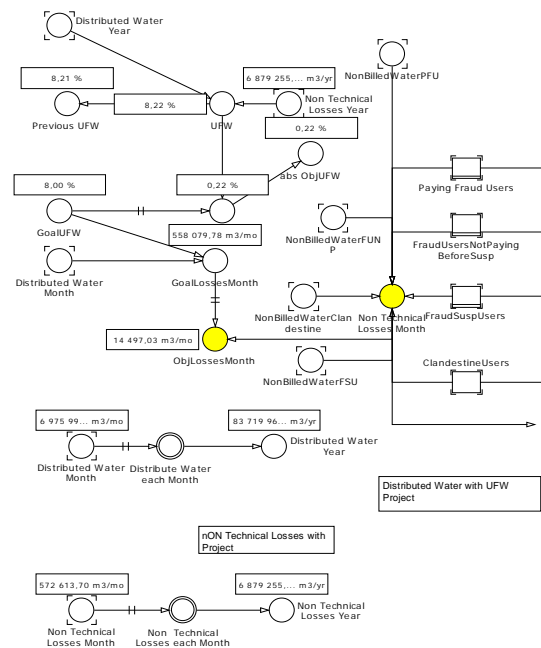

Figure 4.9. Non Revenue Water Subsystem

4.2.5. Utility Workers Subsystem

This subsystem is based on Amap Model. Here workers are classified as inspectors and suspension workers. The main task the inspectors should do is to discover frauds and normalize users (turn frauders into normal users). The number of inspectors depends of how many users per month should be normalized.

On the other hand, suspension workers must verify that suspended users have their service cut-off. If users still have water (legally), these workers should suspend the service to these users as soon they can. Eventually, they may discover frauds and illegal means to connect to the service in suspended users, and they can notify the company in order to normalize fraudulent users.

Non-Revenue Water Reduction Programs: Methodology Analysis using a System Dynamics Approach.

Figure 4.10 shows the dynamics of these two workers, and how many of them are needed to carry out their tasks.

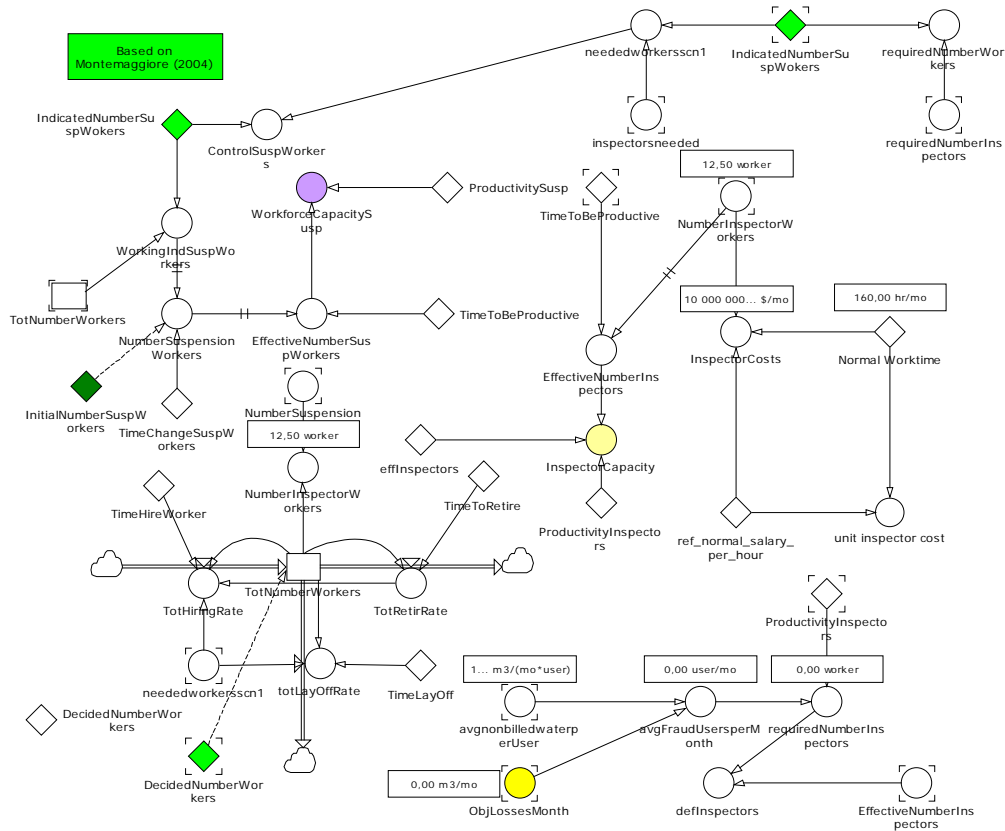

Figure 4.10. Utility Workers Subsystem

4.2.6. Normalization Subsystem

Based on the model made by Toro, the system describes the relations between Non Revenue Water and Inspection. It also determines how many users will be normalized (fraud users into normal ones), taking budget constraints into account. The difference between this model and the one made by Toro is the use of table functions, instead of the use of econometric functions to adjust the model as Toro did in his work.

**Non-Revenue Water Reduction Programs:
Methodology Analysis using a System Dynamics Approach.**

Figure 4.11 shows the effect of the objective UFW (Non Revenue Water) in the water company budget used by the company to reduce water losses.

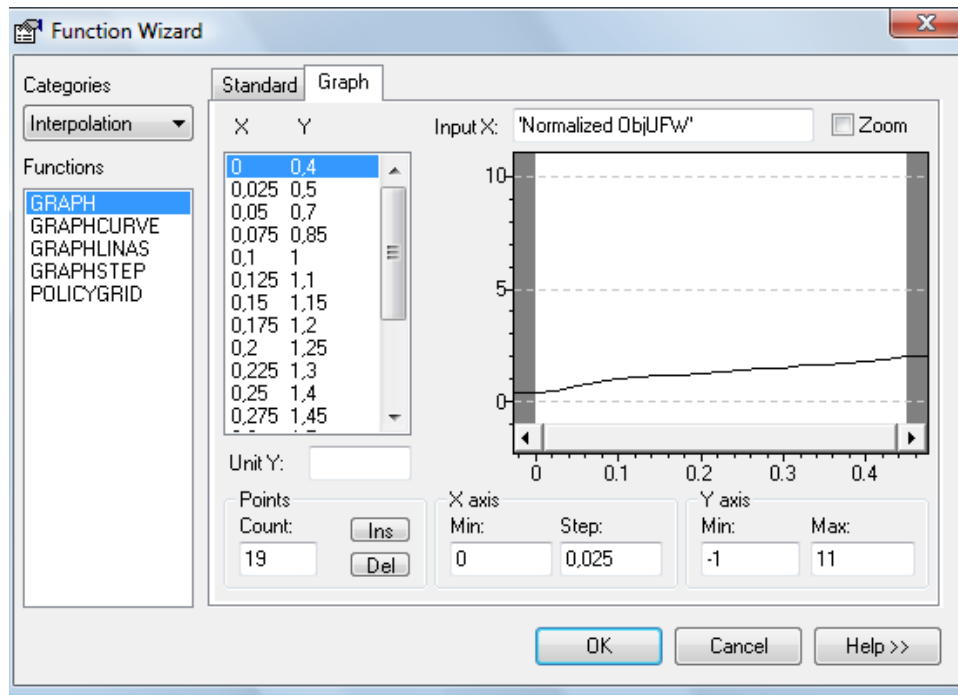

Figure 4.11. Effect of Objective NRW on Budget

The Number of inspector workers, which is also an input in the workers subsector, is determined by the budget spent to reduce water losses. This is the number of needed workers to accomplish the Non Revenue Water Goal the company expected.



Non-Revenue Water Reduction Programs: Methodology Analysis using a System Dynamics Approach.

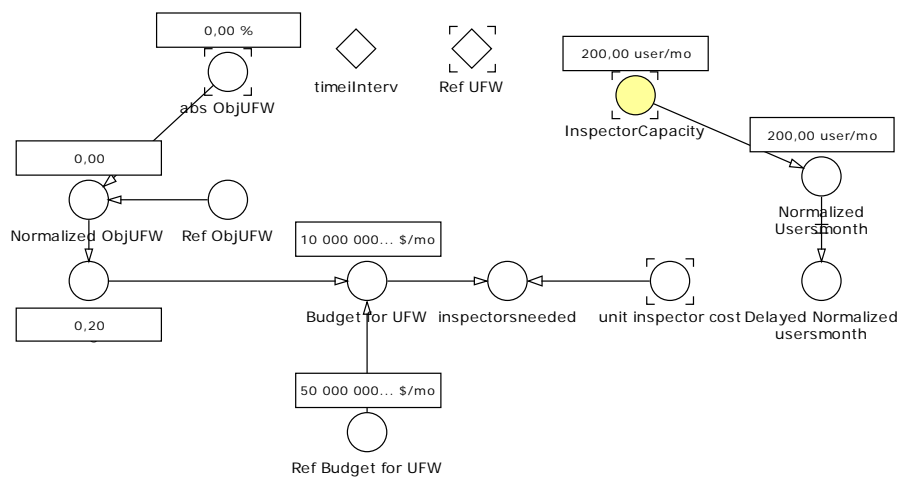

Figure 4.12. Normalization Subsystem

4.2.7. Revenues Subsystem

This is a simple model which simulates cash flow in a water company. Here, revenues depend on how much water is consumed, billed and paid⁴³.

It is assumed that incomes are the amount of money for billed (and paid) water in one month period plus penalties by inspections. Outcomes are expenses like budget for Non Revenue Water Programs and lost money due to frauds (money which the company does not receive).

⁴³ The credits collection subsystem was also taken from AMAP model, and adapted to this research.



Non-Revenue Water Reduction Programs: Methodology Analysis using a System Dynamics Approach.

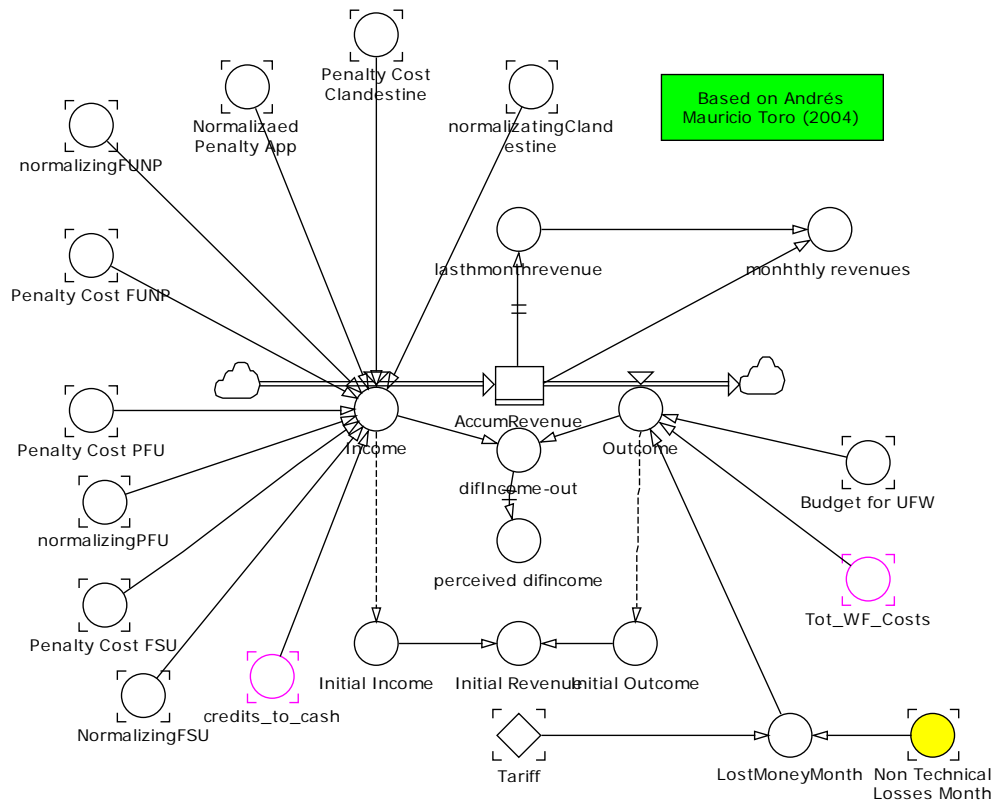

Figure 4.13. Revenues Subsystem

$$\text{Tot_WF_Costs} = \text{Inspector Workforce Costs} + \text{Suspension Workforce Costs}$$

Although this section of the model does not include other financial variables, it is useful to show the differences in revenues when a water loss program is implemented. In effect, the model has three basic runs: One without the water loss program, the other simulating how EPM has done from 2003 to 2008 and other run with a more aggressive and ambitious Water Loss Program (see Chapter 6, Policies).

4.2.8. Credits Collection Subsystem

This part of the model was taken from AMAP and adapted to the context of this research. The main reason in simulating the credits collection activity was the existing relation between credits collection and user dynamics. The more users paying of time, the more credits will turn into cash, increasing income and revenues.

As the same way that users can go from paying to suspended and expired, credits are differentiated depending on the state of the user chain. For example, "First Stage Credit" corresponds to credits coming from people who pay on time; "Short Delay Credits" from delayed paying people, "Credits with suspension" from people already suspended and "Credits After Expiration" from expired users. Moreover "Credits After Expiration" can turn into "Credits Written Off". When a credit reaches this stage, lawyers will deal with this matter, because it is very difficult to compel the user to pay.

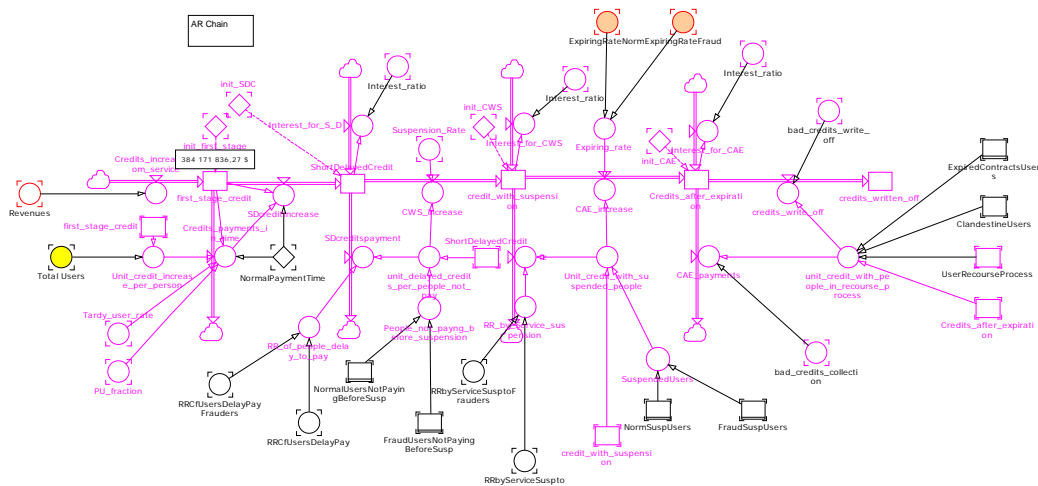

Figure 4.14. Collection Process. Source: Lu, Marrone and Montemagiore (2004)



**Non-Revenue Water Reduction Programs:
Methodology Analysis using a System Dynamics Approach.**

5. Model Validation

5.1. Generalities

Model Validation is a necessary step to know how useful is the model with respect to one or more purposes (Oliva, 2003)⁴⁴. In fact, one of the purposes of a system dynamics model is to evaluate alternative structures to improve the behavior. In this research, validation process was done following guidelines for model validation by Barlas^{45 46}.

Although it was possible to collect data from the Water Utility, not all of them had relevance for the purpose of this project. In addition, only data regarding users, non revenue water and losses were available from year 2003 to 2005 (in some cases 2006). As a result, validation was focused on testing the structure consistency of the model than behavior resemblance to real system.

Logical consistency of the model was considered and the model output was compared with historical and projected trends. Only Non Revenue Water values (historical and projected) were used for comparison (see graphs 5.1 through 5.9). The values of parameters and input functions in the model were researched, some of them were obtained directly from meetings with technical staff from the Utility, and the rest of them with available technical documentation.

⁴⁴ Oliva, R. "Model Calibration as a Testing Strategy for System Dynamics". European Journal of Operational Research 151. pg 552-568. Elsevier B.V.

⁴⁵ Barlas, Y. "Formal Aspects of Model Validity and Validation in System Dynamics". System Dynamics Review 12. pg 183-210.

⁴⁶ Barlas, Y. and Kanar, K. "Structure-oriented Behavior Tests in Model Validation. System Dynamics Conference Proceedings. 2000.



Non-Revenue Water Reduction Programs: Methodology Analysis using a System Dynamics Approach.

5.2. Direct structure test

This test shows how suitable is the model by direct comparison with knowledge and information about the real system (Forrester and Senge 1980). It comprises structural and parameter confirmation tests.

The structure of the model reflects the causal relationships governing the most relevant processes related with commercial losses. The equations and relationships were checked and evaluated: some of them were already evaluate by the different authors in which this research was based, and the others came by other sources: interviews at the Water Utility, documents and datasheets.

The model made by Toro and the way it dealt with the problem of commercial losses in energy was used in analyzing the commercial losses in water utilities, but knowing that water companies have their own particularities. Consequently, the equations used to formalize causality were built based on the available knowledge in the literature and interviews with people at the company.

Although Toro Model was taken as a departure point of this research, the equations were not replicated, due to a high use of econometric functions to express relations between variables.

Also, during the model creating process, parameters were validated using descriptions from Toro, Raimondi and Montemaggiore´s models. Other parameters and table functions were assumed, but they were checked as well.

The dimensional consistency was checked manually, to ensure an adequate representation of the real world. Although Powersim Studio does not have a



proper dimensional analysis feature like the one found in Vensim, it helps the modeler to assign units correctly, by showing error messages when wrong units are placed in the variables.

In the case of Table Functions, relative effects were used in order to work with adimensional Table Functions. By the use of adimensional functions, dimensional inconsistencies and errors could be avoided or minimized.

5.3. Structure oriented behaviour tests

These tests can determine the validity of the model structure by applying behaviour tests which generate certain patterns. In order to keep concepts simple but trying to establish a proper validation process, only extreme conditions test and sensitivity analysis were used.

5.3.1. Extreme condition tests

This test evaluates how valid and consistent is the model under extreme conditions. Indeed, some of these conditions may not occur in real life, but they are necessary to determine the robustness of the model (Peterson and Eberlein 1994)⁴⁷. Figures 5.1. to 5.4. show simulation runs of extreme condition tests. Also parameters set to extreme values are listed in table 5.1.

⁴⁷ Erbelein, R. And Peterson, D.W "Understanding models in VENSIM". Modeling for Learning Organizations. Productivity Press. 1994.



**Non-Revenue Water Reduction Programs:
Methodology Analysis using a System Dynamics Approach.**

Test	Parameter	Reference Value	Extreme Value
1	Time to Normalize	3 months and 4 months for Paying Users	200 months
2	Minimum Time to Suspend	2 months	200 months
3	Decided Number of Workers (init)	19 workers	0 workers
4	Inspector Efficiency	20 %	0 %
5	Time to Commit Fraud (all users except Expired Contract Users)	3 months	200 months

Table 5.1. Parameters Used in Extreme Condition Tests

5.3.1.1. Test 1: Time to Normalize= 200 months

This test assumes a time to normalize fraud users of 200 months (more than the current simulation time). Users and Non Revenue Water Index were compared to see how the model behaves when this parameter changes. In figure 5.1, the green line in the graph shows Non Revenue Water Index when Time to Normalize is 3 months to delayed, suspended and clandestines and 4 months for paying fraud users. The blue line shows the behavior when time to be honest is increased to 200 months.

With this variation, it is shown that NRW increases and goes away from the goal.



Non-Revenue Water Reduction Programs: Methodology Analysis using a System Dynamics Approach.

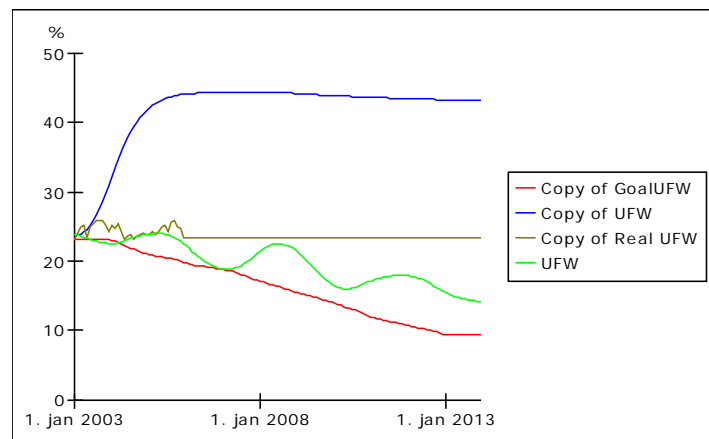

Figure 5.1. Non Revenue Water Index. Time to normalize=200 months.
Reference Mode (Green Line), Test 1 (blue line)

5.3.1.2. Test 2: Minimum Time to Suspend=200 months

When time to suspend is increased to a value beyond the simulation time, there will be more users not paying on time, and suspended users will drop. When company do not suspend users, revenues are seriously affected as normal paying users decrease. When time to suspend is 2 months (left graph in figure 5.2), there are more normal paying users than other type, including fraudulent users, but if time to suspend is high, the number of normal paying users will decrease while delayed paying users will increase.

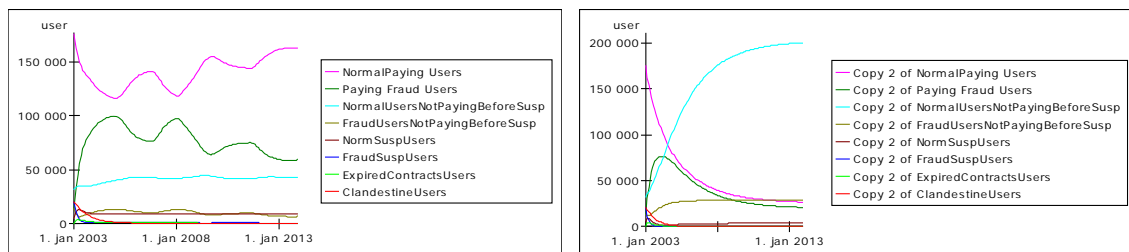

Figure 5.2. User Dynamics. Model With Project (left) – Extreme Condition Test. Minimum Time to Suspend =200 months

**Non-Revenue Water Reduction Programs:
Methodology Analysis using a System Dynamics Approach.**

5.3.1.3. Test 3: Decided Workers: 0 workers

The number of workers will affect Non Revenue Water Index and Revenues. If Initial number of workers is zero, NRW index will increase at the beginning at the simulation, as it can be seen in Figure 5.3.

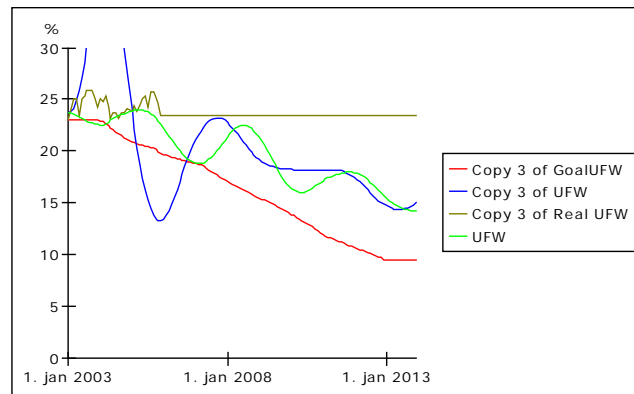

Figure 5.3. Non Revenue Water Index. Test 3: Decided Workers=0 (blue).
Decided Workers=19 (green)

5.3.1.4. Test 4: Inspector Efficiency: 0 %

Efficiency in inspector workers is 15 % approximately. That means at only 15 % of users previously visited by inspectors are normalized. One of the most important factors that affect efficiency is the difficult to find users committing fraud at the moment of inspection. It can be seen that NRW increases as inspection does not work and people are willing to commit fraud as they do not see any risk to be discovered. The perceived costs are lower than the benefits of being fraudulent. As NRW increases, also fraudulent users (see figure 5.4).



Non-Revenue Water Reduction Programs: Methodology Analysis using a System Dynamics Approach.

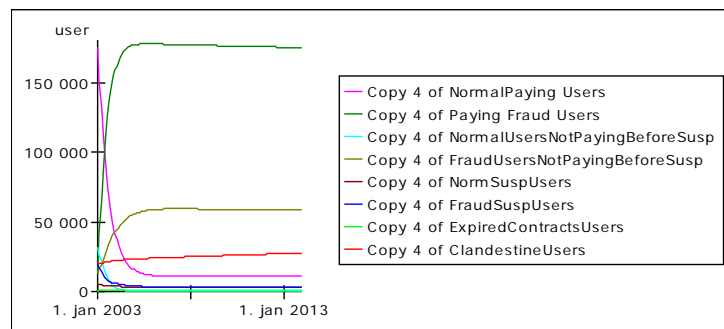

Figure 5.4. User Dynamics. Test 4: Worker Efficiency = 0

5.3.1.5. Test 5: Time to Commit Fraud: 200 months

Normally the act of committing fraud takes time, when the user perceptions of benefits of being fraud are more than costs caused by this illegal practice. It was assumed here that this time of making this choice is 3 months. If this delay time is changed to 200 months, beyond the timeframe, it will change NRW and User Dynamics among other variables, as it appears in figure 5.5.

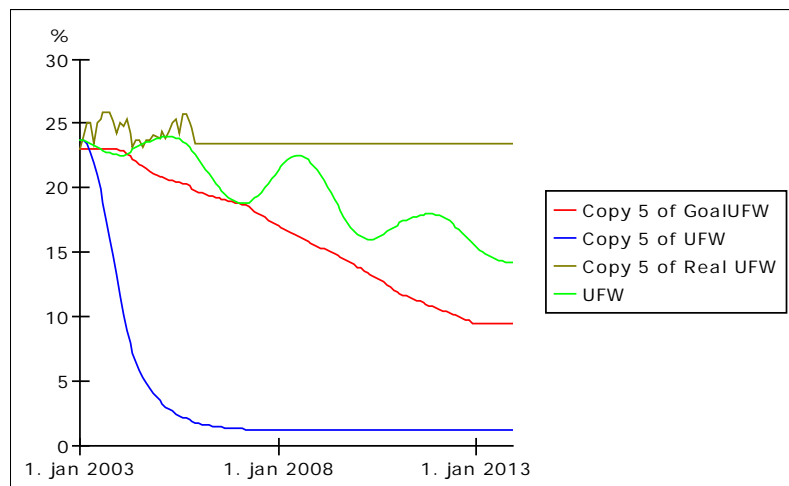

Figure 5.4. Non Revenue Water. Test 5 Time to Commit Fraud = 200 months (blue line).
Reference Mode= 3 months (green line)



5.3.2. Sensitivity Analysis

Sensitivity Analysis is used to determine how “responsive” a model is to changes in the value of the parameters of the model and to changes in the structure of the model.

This analysis is usually performed as a series of tests in which the modeler sets different parameter values to see how a change in the parameter causes a change in the dynamic behavior of the stocks. By showing how the model behavior responds to changes in parameter values, sensitivity analysis is a useful tool in model building as well as in model evaluation.

Additionally, Sensitivity Analysis allows to determine what level of accuracy is necessary for a parameter to make the model sufficiently useful and valid. If the tests reveal that the model is insensitive, then it may be possible to use an estimate rather than a value with greater precision, saving time and costs. Sensitivity Analysis can also indicate which parameter values are reasonable to use in the model.

Furthermore, sensitivity tests help the modeler to understand dynamics of a system. Experimenting with a wide range of values can offer insights into behavior of a system in extreme situations. Also by discovering variations in the system behavior when a change in a parameter value occurs, leverage points can be identified (parameters whose specific value can significantly influence the behavior mode of the system).

Results from Sensivity Tests are shown is Figures 5.5. to 5.9. Also table 5.2 has a list of parameters that were used in these tests.



**Non-Revenue Water Reduction Programs:
Methodology Analysis using a System Dynamics Approach.**

Test	Parameter	Reference Value	Sensitivity Value
1	Percentage of Suspended Users Paying	75 %	70 %
2	Minimum Time to Suspend	2 months	3 months
3	Decided Number of Workers	19	20
4	Inspector Efficiency	15 %	20 %
5	Time to Commit Fraud (only suspended and clandestine users)	2 months	3 months

Table 5.2. Parameters Used in Sensitivity Analysis Tests

5.3.2.1. Test 1: Percentage of Suspended Users Paying: 70 %

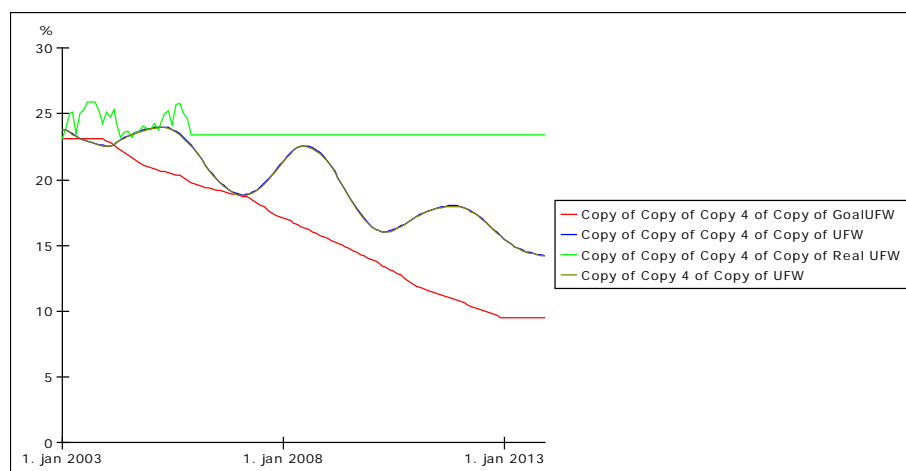

Figure 5.5. Non Revenue Water Index Index. Percentage of Suspended Users: 75 % (brown line) and 70% (blue line). Sensitivity Analysis Test 1.

When the number suspended users who pay to get the service, changes from 75% to 70 %, Non Revenue Water behavior does not change significantly (figure 5.5).



Non-Revenue Water Reduction Programs: Methodology Analysis using a System Dynamics Approach.

5.3.2.2. Test 2: Minimum time to Suspend: 3 months

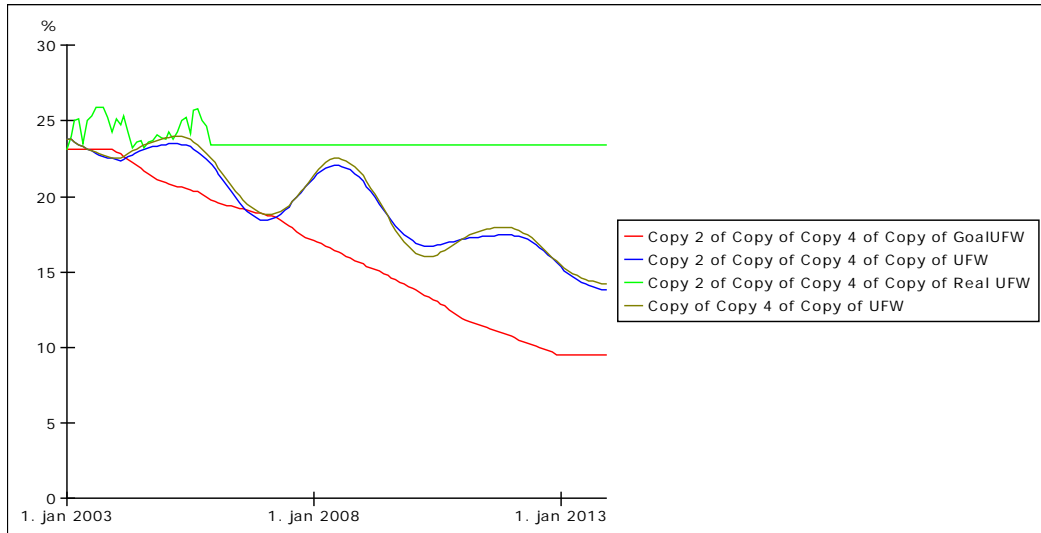

Figure 5.6. Non Revenue Water Index Index. Minimum Timime To Suspend: 3 months (blue). Reference Mode (brown)

Non Revenue Water behavior does not change considerably as time to suspend increases 1 month from its original value (figure 5.6). Changes of this parameters will affect variables like revenues, because there will be less credits to cash.

5.3.2.3. Test 3: Decided Number of Workers: 20

When the number of Workers slightly increases, there are some changes in variables like users or non revenue water index behavior at the beginnig of the simulation, as it is illustrated in Figure 5.7.



Non-Revenue Water Reduction Programs: Methodology Analysis using a System Dynamics Approach.

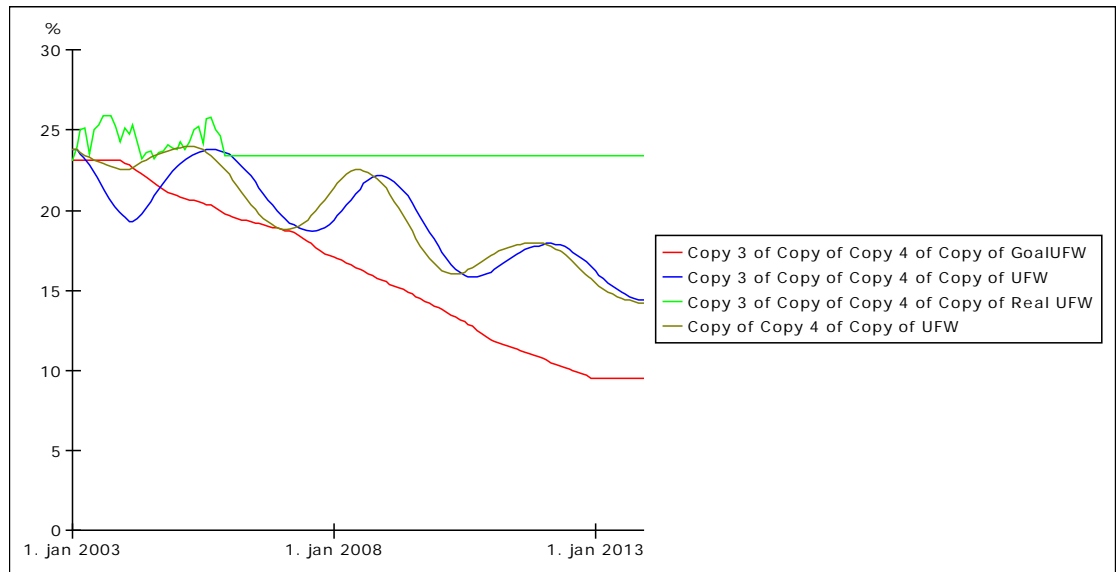

Figure 5.7. Non Revenue Water Index Index. Decided Number of Workers:
20 workers (blue line). Reference Mode: 19 workers (brown line)

5.3.2.4. Test 4: Inspector Efficiency: 20 %

A rise in effectiveness will result in lowering Non Revenue Water Index. Moreover, goal in water losses is exceeded, because the same number of workers will normalize more users than the reference situation. This parameter is found to be more sensible than other parameters, resulting in appreciable changes in outputs like Non Revenue Water Index (Figure 5.8)



Non-Revenue Water Reduction Programs: Methodology Analysis using a System Dynamics Approach.

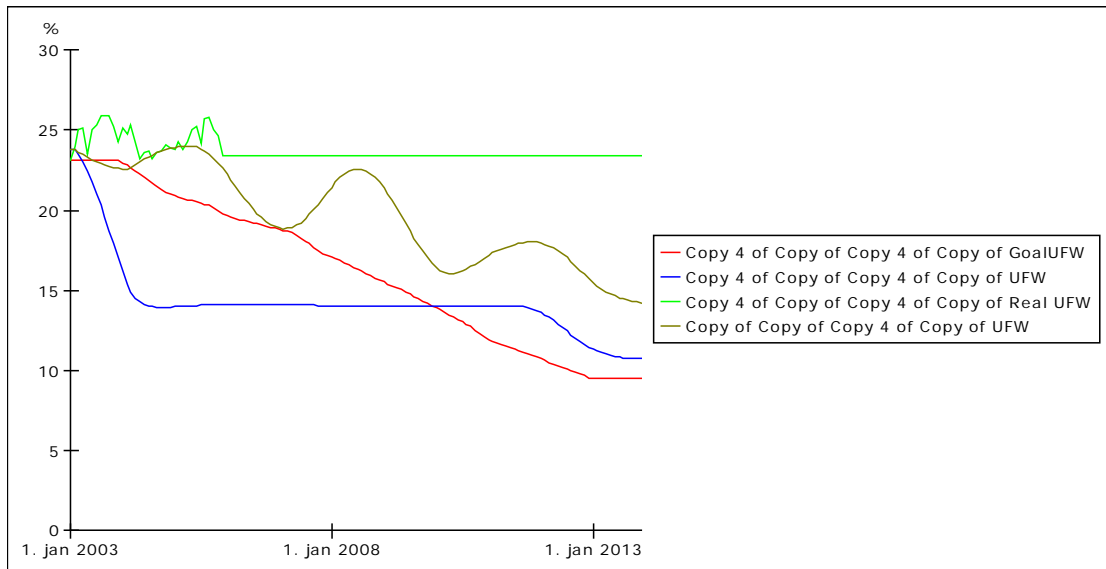

Figure 5.8. Non Revenue Water Index.

Test 4: Inspector Efficiency=20 % (blue line).

Reference Mode, Efficiency= 15 % (brown line)

5.3.2.5. Test 5: Time to Commit Fraud (suspended and expired): 3 months

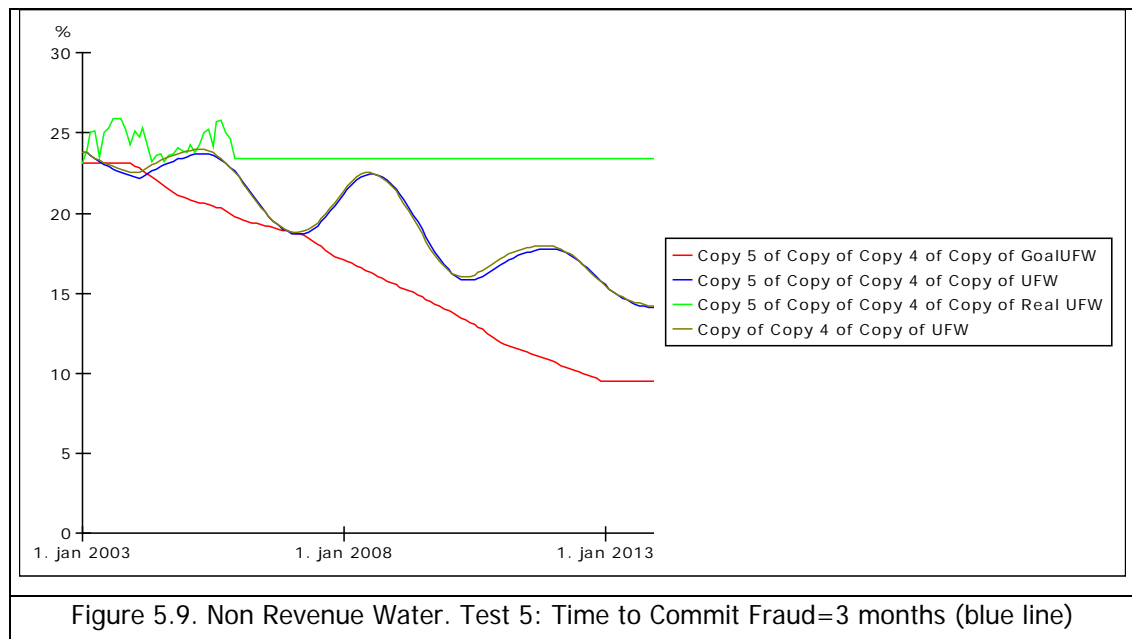

Figure 5.9. Non Revenue Water. Test 5: Time to Commit Fraud=3 months (blue line)



Non-Revenue Water Reduction Programs:

Methodology Analysis using a System Dynamics Approach.

When Time to Commit fraud augments 1 month, the users fraction does not change considerably, compared to the reference mode situation. Although this delay can affect final users share and non revenue water, sensitivity in this parameter is low (Figure 5.9).

5.4. Summary

Modelling is an iterative process, and validation tests should be carried out to see how suitable is the representation of a reality. Extreme Condition Tests and Sensitivity Analysis were made in this research, and their results can be found from Figure 5.1 to 5.9.

The model is more sensitive to changes in productivity and efficiency, than other parameters, as it is illustrated in these figures.



**Non-Revenue Water Reduction Programs:
Methodology Analysis using a System Dynamics Approach.**

6. POLICY ANALYSIS

Policies aimed to reduce water losses normally have a goal Non Revenue Water index which goes in accordance with the utility needs. Then, decisions to carry out policies are taken. Some of the policies usually encouraged are:

Fee Value: Increasing penalties to persuade users to remain honest or to stop committing fraud if they are actually doing it.

Inspection and Normalization.

Other Policies to encourage users to stop committing fraud: Penalty time, disciplinary actions.

Policies to dissuade users to commit fraud: incentives given to honest users, payment options to give suspended and expired contract users an opportunity to have the service back.

Behavior of some variables, previously associated with policies, affects the fraction of users which will commit fraud and users that want to stop stealing water. In consequence, non revenue water index and revenues will be affected due to user dynamics.

One of the key needs of water utilities is to determine what should be the most proficient policy to be carried out, in order to minimize water losses and maximize revenues.

6.1. Varying Non Revenue Water Goals

As mentioned in Chapter 3, Goals in Non Revenue Water Index in EPM were different, varying each 6 months. Initially goals were set from 2003 to 2007 (five years). There were two different goals: One was set in 2003, that is represented as a red line (figure 3.1 and 3.2), but also a “Moving Goal”, that takes into account the real water losses (blue line).

The model has these two goals to work with, being Goal UFW, the one set by the company at the beginning of the simulation (red line in figure 3.1), and Obj UFW (Objective in Non Revenue Water), the perceived Non Revenue Water the Utility should reduce, that is the difference between the goal and the real Non Revenue Water.

There is a delay because the company does not have the information about the value of Non Revenue Water on time. It is assumed here that delay to work with this information is 6 months.

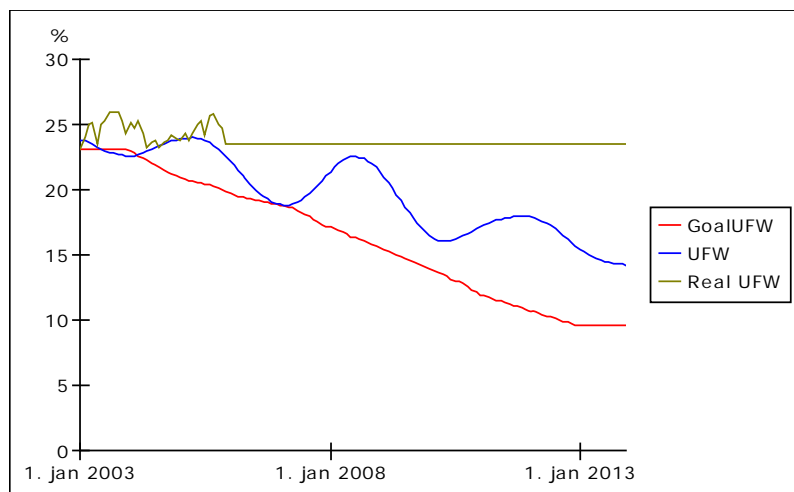

Figure 6.1. Reference Mode of Goal (red line) and Real NRW (green line)
vs Simulated NRW (blue line)



Non-Revenue Water Reduction Programs:

Methodology Analysis using a System Dynamics Approach.

The red line at figure 6.1 corresponds to the one in Figure 3.1 and 3.2 but only having commercial losses into account, which is the interest of this research. Commercial component of water losses is assumed as half of total NRW, starting from 23,08 % in January, 2003.

Goals in Non Revenue Water were defined, but only from 2003 to 2007, so extrapolation was done in this thesis to 2013 to have covered all simulation time. Green Line in this graph represents the real Non Revenue Water index, from 2003 to 2005. More recent data was not possible to get from the company to this research. Finally, the blue line is the simulated Non Revenue Water.

It can be noticed that behavior fluctuates, as historical NRW also does from 2003 to 2005. It is assumed here that behavior trend is periodic and fluctuating

In table 6.1 variations of Non Revenue Water Goal and delay time are listed. Results from these policies are shown in figures 6.2. to 6.5.

Policy	Parameter	Reference Value	Policy Value
1	Non Revenue Water Goal	Table Function	8 %
2	Objective Non Revenue Water	Delay: 6 months	Delay: 1 month
3	Combination of Policy 1 and 2	Same as 1 and 2	8 % and 1 month delay
4	Non Revenue Water Goal	Table Function	23,08 %

Table 6.1. Policies from Changes in Goal NRW and Obj NRW

To see what would happen if a Non Revenue Water Reduction Program is not carried out, a simulation having Non Revenue Water Goal as 23,08 % through all the simulation time was created. This simulation was called here as policy



Non-Revenue Water Reduction Programs: Methodology Analysis using a System Dynamics Approach.

4, although it is not a suggested policy. Results from this simulation are shown in figure 6.6.

6.1.1. Policy 1: Non Revenue Water Goal

By applying this policy, it can be seen that NRW reaches 8 % at almost half time of simulation (5 years). Also users will reach equilibrium in that year (before 2008). It can be seen that normal users and delayed paying users are more than fraudulent users.

Suspended and Expired Contract Users are almost zero, because suspension time and inspection policies working altogether, encourage users to pay on time. Hence, revenues are higher (less water losses and more water paid on time).

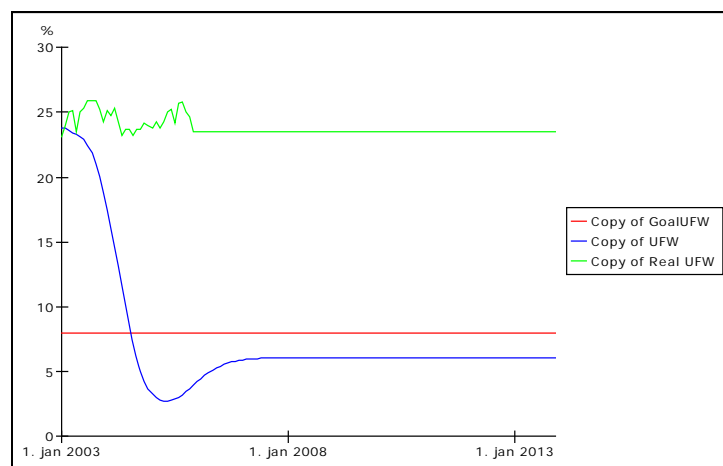

Figure 6.2. Policy 1: Non Revenue Water Goal= 8 %



Non-Revenue Water Reduction Programs: Methodology Analysis using a System Dynamics Approach.

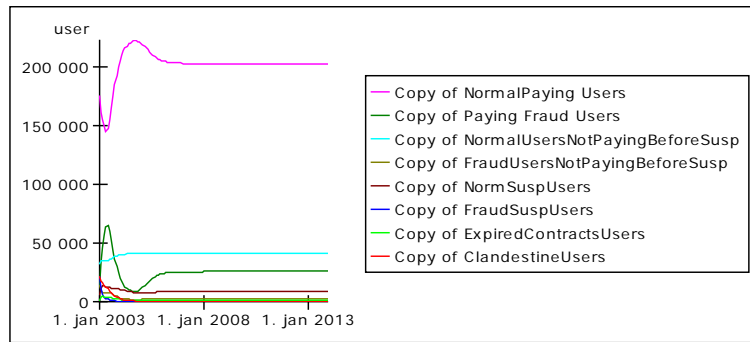

Figure 6.3. Policy 1: User Dynamics

6.1.2. Policy 2: Delay Time in NRW water Objective: 1 month

Working with a lower Delay Time to calculate Non Revenue Water Objective (Goal minus perceived Non Revenue Water Index), results in oscillation with different amplitude (Figure 6.4). Revenues are bit higher in this policy, but oscillatory pattern remains.

This policy could be implemented if the company had a proper information system and good planning. In this case, suitable information means that Non Revenue Water Index from past month should be on time to organize workforce and normalize users. This is the reason why delays are normally higher than 1 month.

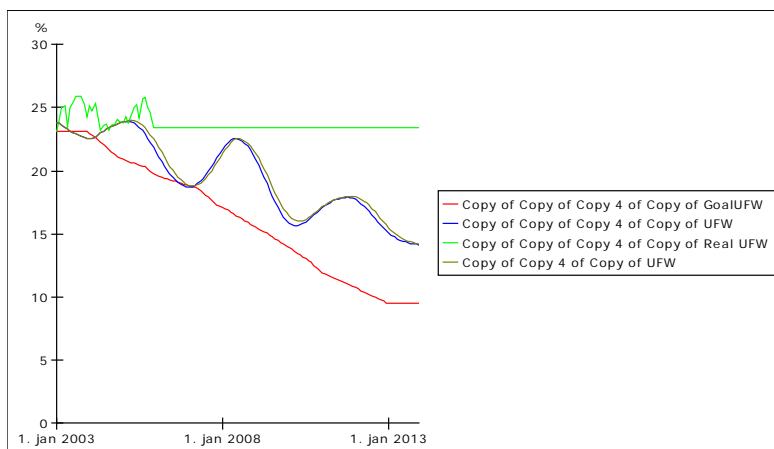

Figure 6.4. Policy 2:

Delay in Non Revenue Water Objective = 1 month (brown line) , reference mode (blue line)



Non-Revenue Water Reduction Programs: Methodology Analysis using a System Dynamics Approach.

6.1.3. Policy 3: Policy 1 and Policy 2 (Delay=1 month, Goal=8%)

Compared to Policy 1, there are no significant changes in Non Revenue Water Index, but accumulated revenues are bit higher. To make this policy feasible, the company must have a good information system for not having more than 1 month delay. Although costs associated on reducing delay could increase, if these costs are lower than associated revenues, policy could be implemented.

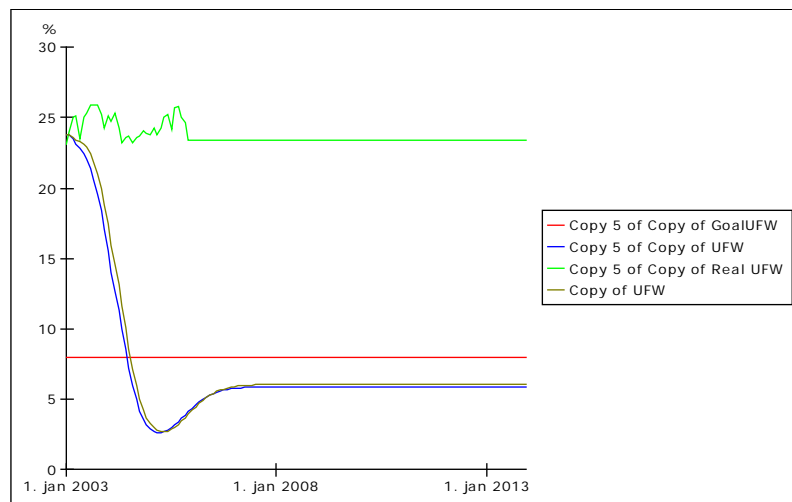

Figure 6.5. Policy 3: Delay in Non Revenue Water Objective= 1 month (brown)
Delay= 6 months (blue) from Policy 1.
Non Revenue Water Goal=8 %

6.1.4. Policy 4: Non Revenue Water Goal=23 %

As explained before, Policy 4 is the extreme case where there is no Water Loss Reduction Plan within the Water Utility. It was used to compare revenues from this situation to other policies, including the reference mode. Figure 6.6 illustrates how Non Revenue Water index behaves during simulation time.



Non-Revenue Water Reduction Programs: Methodology Analysis using a System Dynamics Approach.

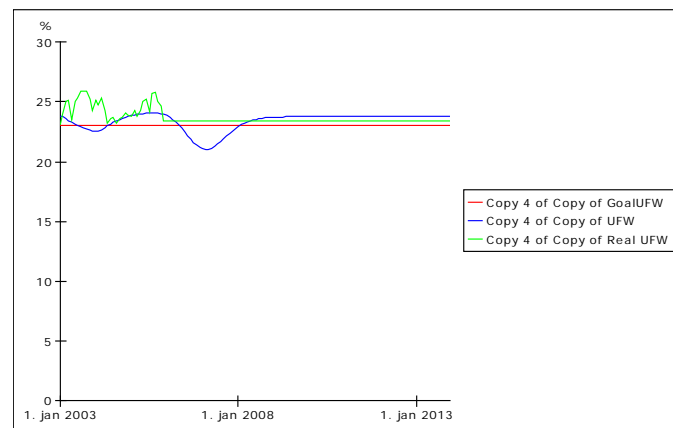

Figure 6.6. Policy 4: Non Revenue Water Goal=23,08 %

It should be noticed that oscillations still occur, because Non Revenue Water Goal is using the 6-month information delay. However, Non Revenue Water index reaches a constant value after year 2008.

Although this situation was assumed as a lacking of Non Revenue Water Reduction Programs, there is, in fact, reduction and normalization when this index goes away from the goal. Therefore, normalization is carried out, but not as exhaustive and successful as the other policies.

6.2. Policies regarding productivity and efficiency

In chapter 5, it was seen that efficiency and productivity in inspector workers are very sensible parameters that influence behavior in Non Revenue Water Index. When efficiency increases, all other factors being equal, Non Revenue Water Index decreases. The same amount of workers will normalize more users if their efficiency is higher. This policy can be applied only if revenues are higher than costs to improve efficiency.

Similar results can be achieved if productivity (number of visited users in a month) rises, because there will be more normalized users.



**Non-Revenue Water Reduction Programs:
Methodology Analysis using a System Dynamics Approach.**

It should be taken into account that improving efficiency (and hence productivity), takes time and has some costs related to this policy. Therefore, the company could have different ways to solve this problem: Either by increasing efficiency by training inspector workers, or by hiring more efficient workers. Also productivity and efficiency can increase as workers gain experience.

Costs are related to training and experience: The more productive and efficient is a worker, the more salary he can obtain. Therefore, when final productivity rises, salaries can increase also, as employees will be quicker and more proficient than employees without experience and training. This also happens when more competent people are hired: Normally, salary in experienced workers is higher than salary in workers with no training or low efficiency.

Table 6.2. includes policies 5 with a higher productivity, efficiency and higher salary. Only this policy regarding efficiency and productivity will be described.

Other policies related to costs of productivity improvement by experience or training could not be validated, since that information was not available while making this research.

Policy	Parameter	Reference Value	Policy Value
Policy 5	Efficiency NRW Goal Productivity	Efficiency= 15 % Productivity=50 user/w/m Variable NRW Goal	Efficiency = 30 % Productivity=80 user/w/mo NRW Goal = 8 % worker salary \$900.000

Table 6.2. Policies from Changes in Efficiency and Productivity



Non-Revenue Water Reduction Programs: Methodology Analysis using a System Dynamics Approach.

6.2.1. Policy 5: Efficiency Improvement

During the modelling process, it was assumed that efficiency took an average value of 15%. This value was obtained from datasheets (2005 and 2006)⁴⁸. In figure 6.7, it can be appreciated that efficiency was not the same during this period: Normalization increased from september 2005 to january 2006, decreased in february 2006 and augmented again until may 2006, but the number of inspections were considerably higher and efficiency decreased from 27 % to 4 % in february 2006.

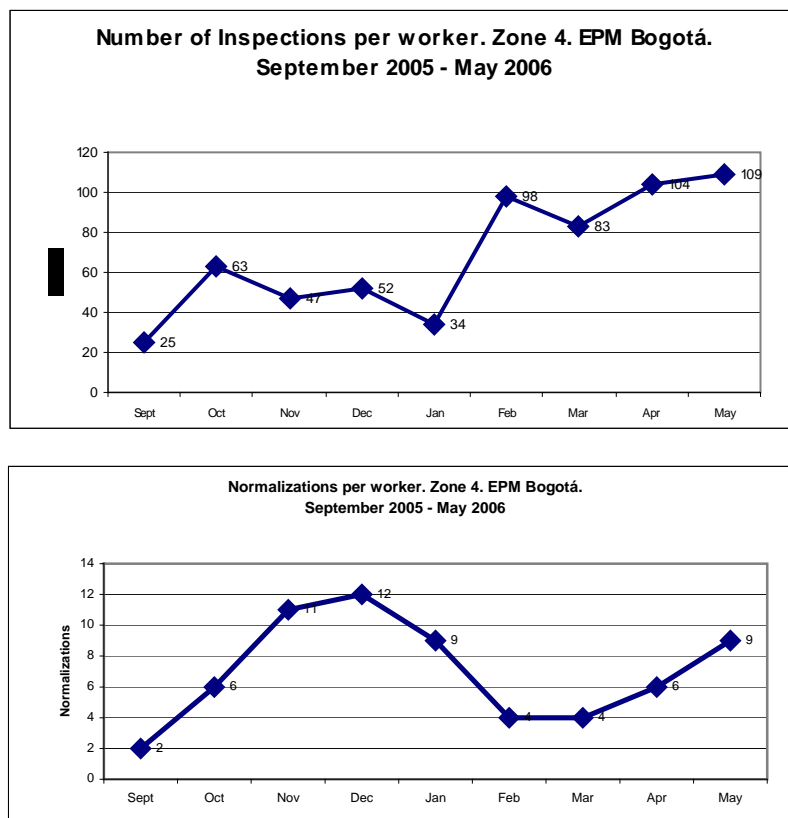

Figure 6.7 Inspector Visits and Normalizations per month

⁴⁸ Appendix 2. Excel Data from EPM: File: InspectionsMay06.xls (Fraudulent Users Inspection, May 2006)



Non-Revenue Water Reduction Programs: Methodology Analysis using a System Dynamics Approach.

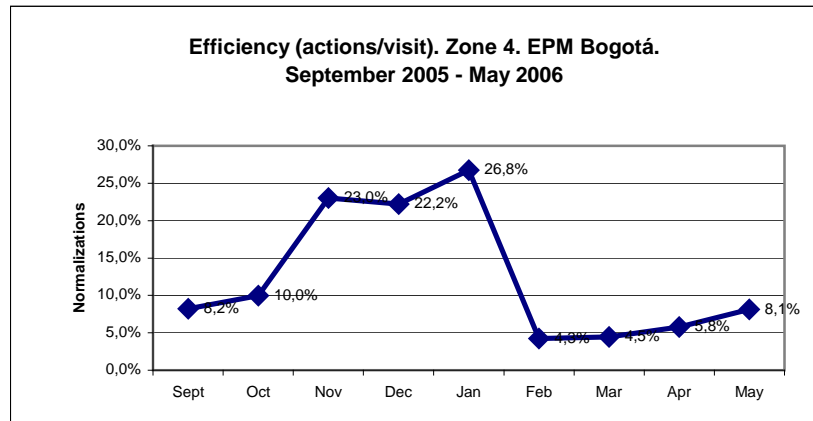

Figure 6.8 Inspector Efficiency per month

Although efficiency and productivity have variations, information only covers 9 months, comparing to the simulation time (10 years), so they were assumed as constants.⁴⁹

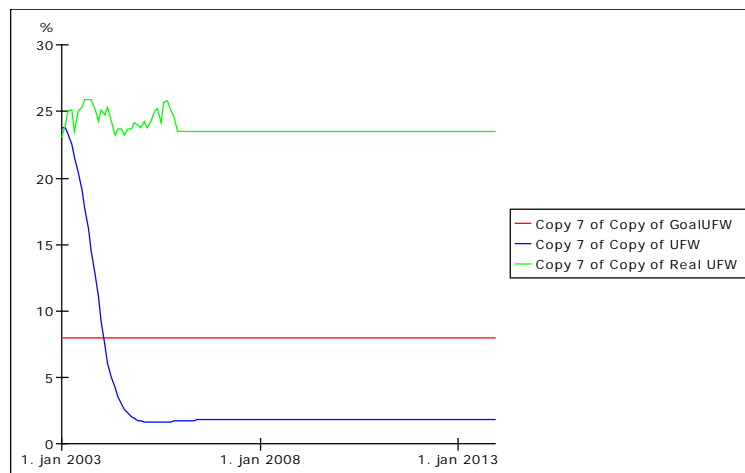

Figure 6.7 NRW Index: Goal NRW=8%, productivity: 80 user/worker/month. Efficiency:30 %

⁴⁹ The model can be improved if productivity and efficiency were not taken as constants. Indeed, in methodologies like Balanced Scorecard, productivity is considered. And according to Kaplan and Norton, productivity can be improved by training. If this model is used as a reference to further works, it is recommended to include productivity in the model, not only as a exogenous variable.



**Non-Revenue Water Reduction Programs:
Methodology Analysis using a System Dynamics Approach.**

As productivity and efficiency are sensible parameters, it can be seen that NRW index decreases until reaching a value between 0 and 5 % (figure 6.7).

Table 6.3. will show the accumulated revenues at the end of simulation for all these 5 policies. This is useful to determine which of the policies can be more effective to apply in the water utility.

Policy	Accumulated Revenues
Reference Mode	\$ 15.851.599.972
Policy 1	\$ 20.277.252.176
Policy 2	\$ 15.945.316.736
Policy 3	\$ 20.528.285.702
Policy 4	\$ 13.960.770.723
Policy 5	\$ 22.710.300.719

Table 6.3 Accumulated Revenues by Policy

Policy 5 was the policy which reached more revenues, if a salary of \$ 900.000 is considered. Higher salaries and costs related to productivity and efficiency will make these revenues not to be high as the shown in table 6.3. Also policy 1 and 3 were profitable. The reason why these 3 policies were better than the base line (reference mode), policy 2 and 4, was the fact of taking NRW as a fixed number at the beginning.



**Non-Revenue Water Reduction Programs:
Methodology Analysis using a System Dynamics Approach.**

7. CONCLUSIONS

The current legal framework on public services in Colombia and the increasing concern of water as a scarce resource, has forced Public Utilities to be competitive and environmental oriented. For that reason, water utilities are required to have projects to diminish technical and commercial losses.

Although there have been some successful results in applying these projects, there are still some methodology flaws in the definition and analysis of the water loss problem, since this problem has a lot of complexity associated. To facilitate the analysis, a system dynamics approach was proposed, and a model was done in order to ease the understanding of water loss problem, giving insights to decision makers to evaluate policies aimed to reduce losses.

As a reference point, models from Toro (2004) and Montemaggiore (2004) were used and adapted to the case of colombian water utilities. The final model was calibrated, using historical data from EPM Bogotá Aguas E.S.P, a colombian water utility. A set of policies aimed to reduce water loss were analysed.

The model also took elements from Crime Theory to explain why water losses occur: It is assumed that users are rational in their decisions, and the choice of committing fraud depends on the perception about benefits and costs of fraud. These elements were used by Toro (2004) and Raimondi (2002). Other models like Laublie (2005) and Dudley (2004) considered these elements from this theory, as well.

The use of system dynamics eases the understanding of the water loss problem which Colombian Water Utilities have been dealing with. The model



Non-Revenue Water Reduction Programs:

Methodology Analysis using a System Dynamics Approach.

can be used as a decision tool to analyse which are the most efficient policies to be carried out in EPM in terms of Water Loss Reduction.

Even with the limited information resources available, the model presented in this research has been able to give insights into the water loss problem. This appears to indicate that system dynamics modeling can be a useful method in order for enhancing the understanding of complex dynamic problems in water utilities.

Results from the model showed that behavior of Non Revenue Water index is very sensitive to variations in efficiency. Therefore, policies leading to improving efficiency should be studied, because they can be implemented to achieve goals in water loss reduction.

Policies regarding penalizing actions do not affect considerably the Non Revenue Water Index, but they should be taken into account because they can be used as persuasive methods to encourage people to be honest.

Policies regarding efficiency (normalizing users per month) and productivity (visited users per month) were found suitable, because of their great impact on Non Revenue Water Index.

The System Dynamics model was calibrated with historical data from EPM Bogotá Aguas E.S.P., therefore it can be used to analyse future responses from more set of policies beyond this research. Moreover, the model can be adjusted to analyse water losses from other type of users (commercial, industrial and other types of organizations like hospitals and schools, among others)

Fraud is also a common problem faced by different types of business. Some of the most common types of fraud include energy losses, free riding in



Non-Revenue Water Reduction Programs:

Methodology Analysis using a System Dynamics Approach.

public transportation, tax evasion, mobile cloned lines, phishing and identity theft. Thus, the model in this research can be adjusted to these particular characteristics of different types of fraud. However, it is necessary to modify the structure of this model to be able to represent fraud problem in other contexts.

Policies analysed and carried out by EPM to reduce water loss, should increase the perceived costs by users willing to commit fraud. Perceived benefits also should be decreased.



**Non-Revenue Water Reduction Programs:
Methodology Analysis using a System Dynamics Approach.**

8. RECOMMENDATIONS AND FUTURE RESEARCH

The System Dynamics model in this research was used to analyse one type of water losses, assuming that all these losses were caused by fraud. In the practice, water losses are technical and commercial and each one of them is caused by several factors, being fraud only one part of them. It should be interesting to consider technical losses, then.

The model can be expanded to simulate water tariff dynamics, because tariff was considered exogenous. It is recommended also to simulate water losses in other type of users (commercial, industrial and government). The cost structure (internal processes, information systems) at the water company is another issue that can be modelled.

As a further research, water demands can be modelled to study the effect of tariff in Water Demand, and hence this same effect, increasing or decreasing water fraud.

Other hypothesis of fraud, can be analysed like social capital, cultural and moral causes to combine with crime theory. In addition, research is needed to investigate and model more aggressive measures to reduce water losses from commercial and technical points of view.



**Non-Revenue Water Reduction Programs:
Methodology Analysis using a System Dynamics Approach.**

9. BIBLIOGRAPHY

Aslam, J., Saeed, K. 1995. Electricity Conservation in Domestic Sector of Pakistan: A System Dynamics Approach. Proceedings of the 1995 International System Dynamics Conference, Tokyo, Japan

Barlas, Y. "Formal Aspects of Model Validity and Validation in System Dynamics". System Dynamics Review 12. pg 183-210.

Barlas, Y., Kanar, K. "Structure-oriented Behavior Tests in Model Validation. System Dynamics Conference Proceedings. 2000.

Becker, G "Crime and Punishment". The Journal of Political Economy. Vol. 76, No. 2. 1968, pp. 169-217

Bianchi, C., Montemaggiore, G. "Building Dynamic Balanced Scorecards to Enhance Strategy Design and Planning in Public Utilities: Key Findings from a Project in a City Water Company". Revista Dinámica de Sistemas. Vol 2. Num. 2. 2006

Dudley, R. "A System Dynamics Examination of the Willingness of Villagers to Engage in Illegal Logging" Journal of Sustainable Forestry, Volume 19. PP 31-53 (22) . 2004

Erbelein, R., Peterson, D.W "Understanding models in VENSIM". Modeling for Learning Organizations. Productivity Press. 1994.

Hernández, J., Dyner, I. "Crisis in Colombian Prisons: Cause or Consequence of a Flawed Judicial System". Conference Proceedings of The 19th (2001)



**Non-Revenue Water Reduction Programs:
Methodology Analysis using a System Dynamics Approach.**

International Conference of the System Dynamics Society (Atlanta, Georgia)
2001

Jaen, J., Dyner, I. "Espirales de la Violencia" (Spirals of Violence) . Revista Dinámica de Sistemas Vol 1. Num 1. 2005

Kaplan, R., Norton, D. "Balanced Scorecard, Translating Strategy Into Action" . Harvard Business School Press. 1996.

Lu, G., Marrone, G. , Montemaggiore, G. "Measuring Performance in a Water City Company through a Balanced Scorecard" . Proceedings of the System Dynamics Conference in Palermo. 2002.

Oliva, R. "Model Calibration as a Testing Strategy for System Dynamics". European Journal of Operational Research 151. pg 552-568. Elsevier B.V.

Raimondi, V. "Organized Crime and Economic Growth". Proceedings of the 2001 System Dynamics Conference.

Rich, E., Martinez, I., Conrad, S. ,Cappelli, D. ,Moore, A., Shimeall, T., Andersen, D. , Gonzalez, J. , Ellison, R., Lipson, H., Mundie, D. , Sarriegui, J., Sawicka, A., Stewart, T., Torres, J. , Weaver, E. , Wiik, J. "Simulating Insider Cyber-Threat Risks, a Model-Based Case and a Case-Based Model". Conference Proceedings of The 23th (2005) International Conference of the System Dynamics Society. 2005

Ritchie-Dunham, J., Rabbino, H. "Managing from Clarity". Chichester: John Wiley & Sons. 2001

Sterman, J. "Business Dynamics: Systems Thinking and Modelling for a Complex World " Mc. Graw Hill. 2000.



**Non-Revenue Water Reduction Programs:
Methodology Analysis using a System Dynamics Approach.**

Toro, A. "Una Aproximación Metodológica Basada En Dinámica De Sistemas Para El Análisis De Las Pérdidas No Técnicas De Energía En El Sector Residencial De Una Empresa Electrificadora". Master Thesis. 2004. Universidad Nacional de Colombia. Copies are available on demand at the library of Universidad Nacional.

Wiik, J.,Gonzalez, J. "Limits to Effectiveness in Computer Incident Response Teams" . Conference Proceedings of The 23th (2005) International Conference of the System Dynamics Society. 2005

Internet Sources:

AMAP S.P.A. Palermo Water Utility.

<http://www.amapspa.it>

Bogota Water Utility (Acueducto de Bogotá)

www.acueducto.com.co

Colombian Water Regulatory Commission

<http://www.cra.gov.co>

Domínguez C., Uribe, E. Water Distribution and Sewage System Evolution during the last decade. Andes University. DOCUMENT CEDE 2005-19

<http://economia.uniandes.edu.co/es/content/download/2053/12086/file/d2005-19.pdf>

EPM Bogotá Aguas

www.epmaguas.com



**Non-Revenue Water Reduction Programs:
Methodology Analysis using a System Dynamics Approach.**

EPM: Empresas Públicas de Medellín. Water, Energy and Telecommunications Utility in Medellín, Colombia

<http://www.epm.com.co>

International Water Association.

<http://www.iwapublishing.com/pdf/Waterloss-Aug.pdf>

Laublie, J. "Fraud in Transportation Systems". 2005. Ventana Systems Internet Forum and System Dynamics e-list.

<http://www.ventanasystems.co.uk/forum/viewthread.php?tid=2564>

Law 142/1994. "Public Domestic Services Law"

http://www.cra.gov.co/resources/ley_142.doc

Membrillo, A., García C., Polo, F., Méndez, A. Enei, E. "Evolution of a Systemic Approach Application for the Management of the Water Supply and Collection System in the City of Leon". 2002. Research Papers

<http://www.strategic-clarity.com>

Ministry of Environment, Housing and Regional Development.

<http://www.minambiente.gov.co>

SAPAL: Mexican Water Utility located in Leon, Guanajuato.

<http://www.sapal.gov.mx>

Strategic Clarity: American – Mexican Consultant Company based on Mexico and Texas.

<http://www.strategic-clarity.com>



**Non-Revenue Water Reduction Programs:
Methodology Analysis using a System Dynamics Approach.**

Zuleta F., Montoya, M., Yepes L. "Comercial Losses by Illegal Users, a primary component of water losses on developing countries. The Colombian Case." 2004.

<http://www.sivi.org>



**Non-Revenue Water Reduction Programs:
Methodology Analysis using a System Dynamics Approach.**

**APPENDIX 1.
MODEL EQUATIONS**

```
mainmodel EPM Aggregated Resid {
aux abs ObjUFW {
autotype Real
autounit %
def MAX(ObjUFW;0<<%>>)
doc Function used to avoid negative Objective Non Revenue Water Index
note percentage
}
level Accumltd_credit_costs {
autotype Real
unit $
init 0
inflow { autodef Tot_costs_related_to_credits }
doc FROM AMAP_accumulate costs related to credit collection
note Original unit: "E"
}
level Accumltd_losses_on_credits {
autotype Real
unit $
init 0
inflow { autodef losses_on_credits }
doc FROM AMAP_accumulated losses related to credits collection
}
level AccumRevenue {
reservoir
autotype Real
unit $
init 28668746
inflow { autodef Income }
outflow { autodef Outcome }
doc Accumulated Cash in colombian $.
}
```



Non-Revenue Water Reduction Programs: Methodology Analysis using a System Dynamics Approach.

```
aux Actual_Tariff {
autotype Real
autounit $/m3
def Tariff
doc Water Supply Tariff in Colombian $
}

const AnualInterestRateOnAR {
autotype Real
unit %
init 15
doc Interest Rate per Year in Account Receivables
note Account Receivables is the sum of the stocks along the chain in the financial part in the
bills
collection sector.
}

aux avgFraudUsersperMonth {
autotype Real
autounit user/mo
def ObjLossesMonth/avgnonbilledwaterperUser/TIMESTEP
doc Average numer of Fraudulent Users per Month
}

aux avgnonbilledwaterperUser {
autotype Real
autounit m3/(mo*user)
def 'Non Technical Losses Month'/(ClandestineUsers+FraudSuspUsers+
FraudUsersNotPayingBeforeSusp+'Paying Fraud Users')
doc It is the average volume of water stolen by a fraudulent user in one month
}

aux avrg_daily_salary_per_person {
autotype Real
unit $/(mo*worker)
def ref_avrg_monthly_salary_per_person*cost_growth
doc FROM AMAP: It is the real unit labor cost of service suspension
note Original unit: "E/day/person"
}
```



**Non-Revenue Water Reduction Programs:
Methodology Analysis using a System Dynamics Approach.**

```
level Backoffice_workload {
autotype Real
autounit user
init Expiring_rate*Time_to_analyse_a_recourse
inflow { autodef Expiring_rate }
outflow { autodef Recourse_Rate }
doc the workload for lawyers in Back Office (when users are not longer connected)
note Original unit: "People"
}

aux bad_credits_collection {
autotype Real
autounit user/mo
def UserRecourseProcess/Time_to_settle_recourses*percentage_of_bad_credits_collection
doc Lost credits. Taken from AMAP model
note Original unit: "day"
}

aux bad_credits_write_off {
autotype Real
autounit user/mo
def UserRecourseProcess*(1-
percentage_of_bad_credits_collection)/Time_to_settle_recourses
doc lost credits. taken from AMAP
}

aux Billed Water Month {
autotype Real
autounit m3/mo
def BilledWaterNormalUser*'Normal Users'+BilledWaterFraudulentUser*FraudPayingUsers
doc billed water, counted water in honest and fraudulent users
}

aux BilledWaterFraudulentUser {
autotype Real
autounit m3/(mo*user)
def 'Effect_of_tariff_vari_on_billedDemand FraudulentUser'*RefAvg Billed Water per
Fraudulent User'
doc Billed Water per fraudulent user in one month. This the water not stolen.
}
```



**Non-Revenue Water Reduction Programs:
Methodology Analysis using a System Dynamics Approach.**

```
aux BilledWaterNormalUser {
autotype Real
autounit m3/(mo*user)
def 'Effect_of_tariff_vari_on_billedDemand Normal User'*'Ref Avg Billed Water Normal User'
doc The current water demand of the honest users considering also the influence of the tariff
on the
average consumption.
note Original unit: "m3/day"
}

aux Budget for UFW {
autotype Real
unit $/mo
def 'Effect of UFW on Budget'*'Ref Budget for UFW'
doc This is the real budget, used for Non Revenue Water Reduction Program.
}

aux CAE_increase {
autotype Real
autounit $/mo
def Expiring_rate*Unit_credit_with_suspended_people
}

aux CAE_payments {
autotype Real
autounit $/mo
def bad_credits_collection*unit_credit_with_people_in_recourse_process
doc payment rate associated with recourse policy. Taken from AMAP model
}

level ClandestineUsers {
autotype Real
unit user
init InitClandestineUsers
inflow { autodef IllegReconnectingRate }
outflow { autodef CLAtoECU }
inflow { autodef IncreasinggClandestineUsers }
doc Stock of Clandestine Users
note Clandestine Users are the users not connected to the network but they take by illegal
means.}
```



**Non-Revenue Water Reduction Programs:
Methodology Analysis using a System Dynamics Approach.**

```
aux CLAtoECU {
autotype Real
unit user/mo
def IF(ClandestineUsers>0<<user>>;'fraction of Clandestine Users thinking to stop
frauding'/
TimeToNormalize+normalizingClandestine;0<<user/mo>>)
doc Flow of Clandestine Users turning into Expired Contract Users
}

aux ContractRenewmentRate {
autotype Real
unit user/mo
def (ExpiredContractsUsers-'fraction of ECU tempted to fraud')/TimeRenewContract
doc The number of users reconnected to the network per month.
}

aux ControlSuspWorkers {
autotype Logical
def PAUSEWHILE(IndicatedNumberSuspWokers>neededworkersscn1)
doc Not used in this model, but used for AMAP, in their Balanced Scorecard.
}

level cost_growth {
autotype Real
init 1
inflow { autodef inflation_influence_on_costs }
}

const Cost_Inflation_switch {
autotype Real
init 0
doc If there is inflation, switch value is 1, 0 otherwise
note Original unit: "dimensionless". It not was used in this model
}

level credit_with_suspension {
autotype Real
autounit $
init init_CWS
inflow { autodef Interest_for_CWS }
outflow { autodef fz }
```



Non-Revenue Water Reduction Programs:

Methodology Analysis using a System Dynamics Approach.

```
inflow { autodef CWS_increase }
outflow { autodef CAE_increase }
doc credits with suspended service
note Original unit: "E"
}

level Credits_after_expiration {
autotype Real
autounit $
init init_CAE
outflow { autodef credits_write_off }
inflow { autodef Interest_for_CAE }
outflow { autodef CAE_payments }
inflow { autodef CAE_increase }
doc credits after the contract expired
note Original unit: "E"
}

aux Credits_increase_from_service {
type Real
unit $/mo
def Revenues
doc credit increase rate
note Original unit: "E/day"
}

aux Credits_payments_in_time {
autotype Real
autounit $/mo
def (first_stage_credit/NormalPaymentTime)*PU_fraction-Tardy_user_rate*
Unit_credit_increase_per_person
doc the collection rate of credit payed in time
note Original unit: "E/day"
}

aux credits_to_cash {
autotype Real
autounit $/mo
def CAE_payments+Credits_payments_in_time+fz+SDcreditspayment
doc the flow from credits to cash, the real credit collection rate}
```



Non-Revenue Water Reduction Programs: Methodology Analysis using a System Dynamics Approach.

```
aux credits_write_off {  
autotype Real  
autounit $/mo  
def bad_credits_write_off*unit_credit_with_people_in_recourse_process  
doc the written off rate of bad credits  
note Original unit: "E/day"  
}  
level credits_written_off {  
autotype Real  
unit $  
init 0  
inflow { autodef credits_write_off }  
doc credits already written off, it becomes a sort of cost to the company  
note Original unit: "E"  
}  
aux CWS_increase {  
autotype Real  
autounit $/mo  
def Suspension_Rate*unit_delayed_credits_per_people_not_pay  
doc increase rate of cred with suspension  
note Original unit: "E/day"  
}  
const DecidedNumberWorkers {  
autotype Real  
unit worker  
init 19  
doc Initial number of workers.  
note Although the number is the same as AMAP model, the variables are different.  
}  
aux defInspectors {  
autotype Real  
autounit worker  
def requiredNumberInspectors-EffectiveNumberInspectors  
}
```



**Non-Revenue Water Reduction Programs:
Methodology Analysis using a System Dynamics Approach.**

```
aux Delayed Effect of attractiveness on NPU tempted to fraud {  
autotype Real  
def DELAYINF('effect of Fraud Attractiveness on NPU tempted to fraud';2;1;'effect of Fraud  
Attractiveness  
on NPU tempted to fraud')  
doc This is the attractiveness to fraud, but it is delayed 1 month because the effect of this  
attract. is not  
immediate.  
}  
aux Delayed Effect of attractiveness on NPUNP tempted to fraud {  
autotype Real  
def DELAYINF('effect of Fraud Attractiveness on NUNP tempted to fraud';2;1;'effect of Fraud  
Attractiveness on NUNP tempted to fraud')  
doc This is the attractiveness to fraud, but it is delayed 1 month because the effect of this  
attractivity. is not immediate.  
}  
aux Delayed Effect of attractiveness on NSU tempted to fraud {  
autotype Real  
def DELAYINF('effect of Fraud Attractiveness on NSU tempted to fraud';2;1;'effect of Fraud  
Attractiveness  
on NSU tempted to fraud')  
doc This is the attractiveness to fraud, but it is delayed 1 month because the effect of this  
attract. is not  
immediate.  
}  
aux Delayed Effect of Fraud Attractiveness on Clandestine thinking to stop {  
autotype Real  
def DELAYINF('Effect of Fraud Attractiveness on Clandestine thinking to stop';2;1;'Effect of  
Fraud  
Attractiveness on Clandestine thinking to stop')  
doc the effect of attractiveness but to stop committing fraud  
}
```



**Non-Revenue Water Reduction Programs:
Methodology Analysis using a System Dynamics Approach.**

```
aux Delayed Effect of fraud attractiveness on ECU tempted to fraud {  
autotype Real  
def DELAYINF('effect of Fraud Attractiveness on ECU tempted to fraud';2;1;'effect of Fraud  
Attractiveness  
on ECU tempted to fraud')  
doc This is the attractiveness to fraud, but it is delayed 1 month because the effect of this  
attract. is not  
immediate.  
}  
aux Delayed Effect of Fraud Attractiveness on FPU thinking to stop {  
autotype Real  
def DELAYINF('Effect of Fraud Attractiveness on FPU thinking to stop';2;1;'Effect of Fraud  
Attractiveness  
on FPU thinking to stop')  
doc the effect of attractiveness but to stop committing fraud  
}  
aux Delayed Effect of Fraud Attractiveness on FSU thinking to stop {  
autotype Real  
def DELAYINF('Effect of Fraud Attractiveness on FSU thinking to stop';2;1;'Effect of Fraud  
Attractiveness  
on FSU thinking to stop')  
doc the effect of attractiveness but to stop committing fraud  
}  
aux Delayed Effect of Fraud Attractiveness on FUNP thinking to stop {  
autotype Real  
def DELAYINF('Effect of Fraud Attractiveness on FUNP thinking to stop';2;1;'Effect of Fraud  
Attractiveness  
on FUNP thinking to stop')  
doc the effect of attractiveness but to stop committing fraud  
}  
aux Delayed Normalized usersmonth {  
autotype Real  
autounit user/mo  
def DELAYINF('Normalized Usersmonth';2;1;'Normalized Usersmonth')  
doc normalized users, and it is delayed 1 month because these users from last month will  
influence the decision of other users to commit or to stop committing fraud.}
```



Non-Revenue Water Reduction Programs: Methodology Analysis using a System Dynamics Approach.

```
aux dife fraud {  
autotype Real  
autounit user  
def 'Ref Fraudulent Users'-'Fraud plus Cland Users'  
doc auxiliar variable used to check the model  
}  
aux difIncome-out {  
autotype Real  
unit $/mo  
def Income-Outcome  
doc net income per month  
}  
aux difNormalUsers {  
autotype Real  
unit user  
def 'Normal Users'-'Ref Normal Users'+ 'real Suspended-Users'  
doc auxiliar variable used to check the model  
}  
aux Distribute Water each Month {  
type Real  
unit m3/mo  
dim month  
def FOR(month=1..12|DELAYPPL('Distributed Water Month';month))  
doc used to calculate distributed water per year  
}  
aux Distributed Water Month {  
autotype Real  
autounit m3/mo  
def 'Billed Water Month'+ 'Non Technical Losses Month'  
doc distributed water in one month, the sume of all billed water plus losses.  
}  
aux Distributed Water Year {  
autotype Real  
unit m3/yr  
def ARRSUM('Distribute Water each Month')/12  
doc the array sum of water per month}
```



Non-Revenue Water Reduction Programs:

Methodology Analysis using a System Dynamics Approach.

aux Effect of Fraud Attractiveness on Clandestine thinking to stop {

autotype Real

def GRAPH('Relative Fraud Attractiveness ECU and
Clandestne';0;0,1;{1;0,7;0,50;0,3;0,25;0,2;0,12;0,08;0,04;0,03;0,02})

doc effect of fraud attractiveness on clandestine users thinking to stop stealing water
}

aux effect of Fraud Attractiveness on ECU tempted to fraud {

autotype Real

def GRAPH('Relative Fraud Attractiveness ECU and
Clandestne';0;0,1;{0;0,1;0,20;0,35;0,45;0,55;0,65;0,65;0,65;0,65;0,65})

doc effect of fraud attractiveness on expired contracts users tempted to commit fraud
}

aux Effect of Fraud Attractiveness on FPU thinking to stop {

autotype Real

def GRAPH('Relative Fraud Attractiveness paying
users';0;0,1;{1;0,7;0,50;0,35;0,25;0,15;0,15;0,10;0,05;0,03;0,02})

doc effect of fraud attractiveness on fraudulent paying users, thinking to stop stealing water
}

aux Effect of Fraud Attractiveness on FSU thinking to stop {

autotype Real

def GRAPH('Relative Fraud Attractiveness
Suspended';0;0,1;{1;0,7;0,50;0,35;0,18;0,17;0,1;0,08;0,04;0,03;0,02})

doc effect of fraud attractiveness on fraudulent suspended users, thinking to stop stealing
water
}

aux Effect of Fraud Attractiveness on FUNP thinking to stop {

autotype Real

def GRAPH('Relative Fraud Attractiveness Tardy
Users';0;0,1;{1;0,7;0,50;0,3;0,3;0,2;0,12;0,08;0,04;0,03;0,02})

doc effect of fraud attractiveness on fraudulent non paying users, thinking to stop stealing
water
}



Non-Revenue Water Reduction Programs:

Methodology Analysis using a System Dynamics Approach.

```
aux effect of Fraud Attractiveness on NPU tempted to fraud {
autotype Real
def GRAPH('Relative Fraud Attractiveness paying
users';0;0,1;{0;0,05;0,10;0,15;0,25;0,30;0,35;0,37;0,38;0,39;0,4})
doc effect of fraud attractiveness on honest paying users, thinking to steal water
}

aux effect of Fraud Attractiveness on NSU tempted to fraud {
autotype Real
def GRAPH('Relative Fraud Attractiveness
Suspended';0;0,1;{0;0,11;0,22;0,33;0,44;0,53;0,58;0,62;0,63;0,63;0,65})
doc effect of fraud attractiveness on honest suspended users, thinking to steal water
}

aux effect of Fraud Attractiveness on NUNP tempted to fraud {
autotype Real
def GRAPH('Relative Fraud Attractiveness Tardy
Users';0;0,1;{0;0,1;0,20;0,3;0,4;0,45;0,46;0,47;0,48;0,49;0,5})
doc effect of fraud attractiveness on honest tardy users, thinking to steal water
}

aux Effect of Inspection on Suspended Users {
autotype Real
def GRAPH('Relative Normalization FSU';0;0,2;{0;0,05;0,1;0,2;0,30;0,35;0,4;0,6;1;1,2;1,7})
doc effect of inspection (visits) on normal suspended users
}

aux Effect of Inspection on tardy Users {
autotype Real
def GRAPH('Relative Normalization
FUNP';0;0,1;{0;0,05;0,2;0,4;1;1,35;1,45;1,60;2,15;2,36;2,68})
doc effect of inspections on delayed paying users
}

aux Effect of Normalization on paying Users {
autotype Real
def GRAPH('Relative Normalization PFU';0;0,2;{0;0,15;0,38;0,65;1;1,2;1,5;2;2,2;2,4;2,8})
doc effect of inspection on paying fraudulent users
}
```



Non-Revenue Water Reduction Programs:

Methodology Analysis using a System Dynamics Approach.

aux Effect of Normalizing Expired Users {

autotype Real

def GRAPH('Relative Normalization

Clandestine';0;0,2;{0;0,05;0,15;0,25;0,4;0,6;0,7;0,8;1;1,18;1,28})

doc effect of inspection (visits) on expired contract users

}

aux Effect of penalty application on Perceived Costs for ECU users {

autotype Real

def GRAPH('Normalizaed Penalty App

';0;0,1;{0;0,05;0,08;0,15;0,25;0,40;0,55;0,60;0,6;0,6;0,6})

doc table function describing the effect of penalty application on perceived costs for expired users

}

aux Effect of penalty application on Perceived Costs for paying users {

autotype Real

def GRAPH('Normalizaed Penalty App'

;0;0,1;{0;0,05;0,08;0,15;0,25;0,40;0,55;0,70;0,80;0,9;1})

doc table function describing the effect of penalty application on perceived costs

}

aux Effect of penalty application on Perceived Costs for Suspended users {

autotype Real

def GRAPH('Normalizaed Penalty App'

;0;0,1;{0;0,05;0,08;0,15;0,25;0,40;0,55;0,55;0,6;0,6;6})

doc table function describing the effect of penalty application on perceived costs

}

aux Effect of penalty application on Perceived Costs for tardy users {

autotype Real

def GRAPH('Normalizaed Penalty

App';0;0,1;{0;0,03;0,05;0,10;0,20;0,30;0,45;0,60;0,70;0,75;0,75})

doc table function describing the effect of penalty application on perceived costs

}



Non-Revenue Water Reduction Programs:

Methodology Analysis using a System Dynamics Approach.

aux Effect of UFW on Budget {

autotype Real

def

GRAPH("NormalizedObjUFW";0;0,025;{0,5;0,55;0,60;0,65;0,7;0,75;0,8;0,85;0,9;0,91;0,92;0,93;0,94;0,95;0,96;0,97;0,98;0,99;1//Min:-1;Max:11//})

doc table function describing the effect of Non Revenue Water on budget. When the objective NRW is high, budget is used totally but when objective NRW is very low, not all of budget is used, and could be used in other expenses.

}

aux Effect_of_suspnsn_time_on_bad_crdrts {

autotype Real

def

GRAPH(RealTimeSuspend/MinimumTimeToSuspend;1;2;{1;0,94;0,87;0,77;0,61;0,53;0,46;0,43;0,42;0,41;0,4//Min:0;Max:1;Zoom//})

doc taken from amap. it is the effect of suspension time on bad credits. i.e. credits from expired contract users.

}

aux Effect_of_tariff_vari_on_billedDemand FraudulentUser {

type Real

def

GRAPH(Perceived_tariff_variation;1;0,1;{1,2;1,191;1,176;1,161;1,148;1,124;1,108;1,084;1,062;1,032;1;0,9;0,85;0,8;0,77;0,75;0,73;0,7//Min:0.7;Max:1.4;Zoom//})

doc The effect of a tariff variation on the water consumption. Although the table function was taken from AMAP model and redefined here, it was not used finally.

note Original unit: "dimensionless". It can be used late in this model

}

aux Effect_of_tariff_vari_on_billedDemand Normal User {

type Real

def

GRAPH(Perceived_tariff_variation;1;0,1;{1,2;1,191;1,176;1,161;1,148;1,124;1,108;1,084;1,062;1,032;1;0,972;0,938;0,9;0,878;0,854;0,85;0,85//Min:0.7;Max:1.4;Zoom//})

doc From Amap:_ENU_The effect of a tariff variation on the water consumption. Not used here

note Original unit: "dimensionless".It can be used late in this model

}



**Non-Revenue Water Reduction Programs:
Methodology Analysis using a System Dynamics Approach.**

aux Effect_of_tariff_vari_on_nonbilledWaterClandestine {

type Real

def

GRAPH(Perceived_tariff_variation;1;0,1;{1;1;1;1;1;1;1;1;1;1;1;1;1;1;1//Min:0.7;Max:1.4;Zoom//})

doc From Amap:_ENU_The effect of a tariff variation on the water consumption. Concept taken from Amap but not used finally in this model

note Original unit: "dimensionless".It can be used late in this model

}

aux Effect_of_tariff_vari_on_nonbilledWatFSU {

type Real

def

GRAPH(Perceived_tariff_variation;1;0,1;{1;1;1;1;1;1;1;1;1;1;1;1;1;1;1//Min:0.7;Max:1.4;Zoom//})

doc The effect of a tariff variation on the water consumption. Not used finally in this model.

note Original unit: "dimensionless".It can be used late in this model

}

aux Effect_of_tariff_vari_on_nonbilledWatFUNP {

type Real

def

GRAPH(Perceived_tariff_variation;-1;0,1;{0,9;0,91;0,92;0,93;0,94;0,95;0,96;0,97;0,98;0,99;1;1,02;1,04;1,06;1,08;1,1;1,12;1,14//Min:0.7;Max:1.4;Zoom//})

doc The effect of a tariff variation on the water consumption. Not used in this model. taken from amap}

aux Effect_of_tariff_vari_on_nonbilledWatPFU {

type Real

def

GRAPH(Perceived_tariff_variation;1;0,1;{0,9;0,91;0,92;0,93;0,94;0,95;0,96;0,97;0,98;0,99;1;1,02;1,04;1,06;1,08;1,1;1,125;1,15//Min:0.7;Max:1.4;Zoom//})

doc The effect of a tariff variation on the water consumption. taken from amap but not used in this model finally

note Original unit: "dimensionless".It can be used late in this model

}



Non-Revenue Water Reduction Programs: Methodology Analysis using a System Dynamics Approach.

```
aux EffectiveNumberInspectors {  
autotype Real  
autounit worker  
def DELAYINF(NumberInspectorWorkers;TimeToBeProductive;1;NumberInspectorWorkers)  
doc effective number of inspectors having efficiency and productivity into account  
}  
aux EffectiveNumberSuspWorkers {  
autotype Real  
unit worker  
def  
DELAYINF(NumberSuspensionWorkers;TimeToBeProductive;1;NumberSuspensionWorkers)  
doc workforce capacity for suspension workers, having efficiency and productivity into  
account  
}  
const effInspectors {  
autotype Real  
unit %  
init 15  
doc assumed as a constant to simplify the model. But according to EPM data from 2005 and  
2006, efficiency varied, depending on number of visits.  
}  
level ExpiredContractsUsers {  
reservoir  
autotype Real  
unit user  
init init_ECU  
inflow { autodef ExpiringRateNorm }  
outflow { autodef ContractRenewmentRate }  
outflow { autodef IllegReconnectingRate }  
inflow { autodef CLAtoECU }  
inflow { autodef ExpiringRateFraud }  
doc Users without service contract.  
}
```



**Non-Revenue Water Reduction Programs:
Methodology Analysis using a System Dynamics Approach.**

```
aux Expiring_rate {  
  autotype Real  
  autounit user/mo  
  def ExpiringRateFraud+ExpiringRateNorm  
  doc the expiry rate associated with people. Taken from Amap model.  
  note Original unit: "People/day"  
}  
aux ExpiringRateFraud {  
  autotype Real  
  autounit user/mo  
  def FraudSuspUsers*(1-PercFSUpaying)/TimeToExpireContract  
  doc the expiry rate associated with fraudulent users  
}  
aux ExpiringRateNorm {  
  autotype Real  
  unit user/mo  
  def NormSuspUsers*(1-PerctgSUpaying)/TimeToExpireContract  
  doc expiry rate associated with honest users  
}  
level first_stage_credit {  
  autotype Real  
  autounit $  
  init init_first_stage  
  inflow { autodef Credits_increase_from_service }  
  outflow { autodef SDcreditIncrease }  
  outflow { autodef Credits_payments_in_time }  
  doc first stage credit associate with people paying in time  
}  
aux fraction_of_Clandestine_Users_thinking_to_stop_frauding {  
  autotype Real  
  autounit user  
  def ClandestineUsers*'Delayed Effect of Fraud Attractiveness on Clandestine thinking to stop'  
  doc fraction of Fraudulent Users who are willing to be honest  
}
```



Non-Revenue Water Reduction Programs:

Methodology Analysis using a System Dynamics Approach.

```
aux fraction of ECU tempted to fraud {  
autotype Real  
autounit user  
def ExpiredContractsUsers*'Delayed Effect of fraud attractiveness on ECU tempted to fraud'  
doc fraction of honest users who are willing to commit fraud  
}  
aux fraction of FPU thinking to stop frauding {  
autotype Real  
autounit user  
def 'Delayed Effect of Fraud Attractiveness on FPU thinking to stop'*Paying Fraud Users'  
doc fraction of Fraudulent Users who are willing to be honest  
}  
aux fraction of FSU thinking to stop frauding {  
autotype Real  
autounit user  
def 'Delayed Effect of Fraud Attractiveness on FSU thinking to stop'*FraudSuspUsers  
doc fraction of Fraudulent Users who are willing to be honest  
}  
aux fraction of FUNP thinking to stop frauding {  
autotype Real  
autounit user  
def 'Delayed Effect of Fraud Attractiveness on FUNP thinking to  
stop'*FraudUsersNotPayingBeforeSusp  
doc fraction of Fraudulent Users who are willing to be honest  
}  
aux fraction of NPU tempted to fraud {  
autotype Real  
autounit user  
def 'NormalPaying Users'*'Delayed Effect of attractiveness on NPU tempted to fraud'  
doc fraction of honest users who are willing to commit fraud  
}  
aux fraction of NSU tempted to fraud {  
autotype Real  
autounit user  
def NormSuspUsers*'Delayed Effect of attractiveness on NSU tempted to fraud'  
doc fraction of honest users who are willing to commit fraud
```



**Non-Revenue Water Reduction Programs:
Methodology Analysis using a System Dynamics Approach.**

```
}  
aux fraction of NUNP tempted to fraud {  
autotype Real  
autounit user  
def NormalUsersNotPayingBeforeSusp*'Delayed Effect of attractiveness on NPUNP tempted to  
fraud'  
doc fraction of honest users who are willing to commit fraud  
}  
aux Fraud Attractiveness ECU {  
autotype Real  
def 'Fraud Benefits ECU'/'Perceived Fraud Costs Expired Users ECU'  
doc fraud attractiveness in expired people (including clandestines)  
note dimensionless  
}  
aux Fraud Attractiveness paying users {  
autotype Real  
def 'Fraud Benefits paying users'/'Perceived Fraud Costs paying users'  
doc fraud attractiveness in paying users  
note dimensionless  
}  
aux Fraud Attractiveness Suspended Users {  
autotype Real  
def 'Fraud Benefits Suspended user'/'Perceived Fraud Costs Suspended Users'  
doc fraud attractiveness in suspended users  
note dimensionless  
}  
aux Fraud Attractiveness Tardy Users {  
autotype Real  
def 'Fraud Benefits Tardy Users'/'Perceived Fraud Costs Tardy Users'  
doc fraud attractiveness in tardy users (not paying on time)  
}  
aux Fraud Benefits ECU {  
autotype Real  
unit $/mo/user  
def (NonBilledWaterClandestine*Tariff)  
doc perceived benefits by Expired and Clandestine users}
```



**Non-Revenue Water Reduction Programs:
Methodology Analysis using a System Dynamics Approach.**

```
aux Fraud Benefits paying users {
autotype Real
unit $/mo/user
def (NonBilledWaterPFU*Tariff)
doc perceived benefits of fraud by paying users
}

aux Fraud Benefits Suspended user {
autotype Real
unit $/mo/user
def (NonBilledWaterFSU*Tariff)
doc perceived benefits by suspended users
}

aux Fraud Benefits Tardy Users {
autotype Real
unit $/mo/user
def (NonBilledWaterFUNP*Tariff)
doc perceived fraud benefits by tardy users
}

aux Fraud plus Cland Users {
autotype Real
unit user
def ClandestineUsers+'Fraud Users'
doc total fraudulent users
}

aux Fraud Users {
autotype Real
unit user
def 'Paying Fraud Users'+FraudUsersNotPayingBeforeSusp+FraudSuspUsers
doc fraudulent users, without including clandestines
}

aux FraudPayingUsers {
autotype Real
autounit user
def FraudUsersNotPayingBeforeSusp+'Paying Fraud Users'
doc users who are billed but they also take water illegally.
}
```



**Non-Revenue Water Reduction Programs:
Methodology Analysis using a System Dynamics Approach.**

```
level FraudSuspUsers {
reservoir
autotype Real
unit user
init InitFSU
outflow { autodef RRbyServiceSusptoFrauders }
inflow { autodef NSUtoFSU }
outflow { autodef FSUtoNSU }
outflow { autodef ExpiringRateFraud }
doc suspended users which take water illegally
}

aux FraudTardyUsersRate {
autotype Real
unit user/mo
def 'Paying Fraud Users'/NormalPaymentTime*PerctgFraudTardyUsers
doc rate to become tardy users
}

level FraudUsersNotPayingBeforeSusp {
reservoir
autotype Real
unit user
init InitFUNPS
inflow { autodef FraudTardyUsersRate }
outflow { autodef SuspRateFrauders }
inflow { autodef NUNPtoFUNP }
outflow { autodef FUNPtoNUNP }
outflow { autodef RRCfUsersDelayPayFrauders }
doc billed people, they do not pay on time but they are billed. Also they take water illegally.
}

aux FSUtoNSU {
autotype Real
autounit user/mo
def IF(FraudSuspUsers>0<<user>>;'fraction of FSU thinking to stop
frauding'/TimetoNormalize+
NormalizingFSU;0<<user/mo>>)
doc flow of users: from fraudulent suspended to honest suspended users}
```



Non-Revenue Water Reduction Programs:

Methodology Analysis using a System Dynamics Approach.

aux FUNPtoNUNP {

autotype Real

autounit user/mo

def IF(FraudUsersNotPayingBeforeSusp>0<<user>>,'fraction of FUNP thinking to stop
frauding'/

TimetoNormalize+normalizingFUNP;0<<user/mo>>)

doc flow from fraudulent tardy to honest tardy users

}

aux fz {

autotype Real

autounit \$/mo

def RR_by_Service_suspension*Unit_credit_with_suspended_people

doc the payment rate associated with service suspension policy

note Original unit: "E/day"

}

aux GoalLossesMonth {

autotype Real

autounit m3/mo

def GoalUFW*'Distributed Water Month'

doc goal in water losses by month

}

aux GoalUFW {

autotype Real

unit %

def

GRAPH(TIME;STARTTIME;TIMESTEP;{23,08;23,08;23,08;23,08;23,08;23,08;23,08;23,08;23,
08;23,08;23,08;23,08;22,93;22,83;22,63;22,43;22,23;22,03;21,85;21,7;21,5;21,3;21,15;21,0
3;20,93;20,8;20,7;20,65;20,6;20,5;20,43;20,37;20,3;20,15;19,95;19,8;19,7;19,6;19,5;19,4;1
9,35;19,3;19,22;19,16;19,08;19,18,92;18,87;18,8;18,74;18,67;18,6;18,4;18,2;18,05;17,9;17
,7;17,5;17,3;17,2;17,1;17;16,85;16,7;16,55;16,4;16,3;16,17;16,05;15,9;15,75;15,6;15,5;15,
35;15,25;15,11;15,02;14,89;14,75;14,6;14,45;14,3;14,2;14,05;13,89;13,77;13,6;13,45;13,3;
13,15;13,12,9;12,75;12,5;12,3;12,1;11,9;11,8;11,7;11,6;11,5;11,4;11,3;11,2;11,1;11,10,9;1
0,8;10,7;10,6;10,5;10,4;10,3;10,2;10,1;10,9,9;9,8;9,7;9,5//Min:0;
Max:10//}<<%>>)

doc goal Non Revenue Water. Time Function starting from 23,08 %. In policies 1 to 3, goal
UFW = 8 %}



Non-Revenue Water Reduction Programs:

Methodology Analysis using a System Dynamics Approach.

aux Gross_margin {

autotype Real

autounit \$/mo

def (Revenues)

doc revenues

note Original unit: "E/days"

}

aux IllegReconnectingRate {

autotype Real

unit user/mo

def 'fraction of ECU tempted to fraud'/TimeToIllegReconnect

doc rate of ECU users reconnecting illegally

}

aux Income {

autotype Real

unit \$/mo

def (normalizingPFU*'Penalty Cost PFU'+normalizingFUNP*'Penalty Cost Fraud Tardy Users
FUNP'+NormalizingFSU*'Penalty Cost FSU'+'Penalty Cost
Clandestine'*normalizingClandestine)/'Normalizaed Penalty App'*1<<mo>>
+credits_to_cash

doc Cash in...monthly: by billed and paid water and by penalties

}

aux IncreasingClandestineUsers {

autotype Real

autounit user/mo

def ClandestineUsers*MonthlyClandIncrease

doc new clandestine users per month, but not coming from ECU users. These are new
clandestines: most

of them are from illegal neighborhoods

}

aux IncreasingRateUsers {

autotype Real

unit user/mo

def 'NormalPaying Users'*MonthlyUserIncrease

doc New users in water supply network. Legal users.

}



**Non-Revenue Water Reduction Programs:
Methodology Analysis using a System Dynamics Approach.**

```
const IndicatedNumberSuspWokers {
autotype Real
unit worker
init 12
}

aux inflation_influence_on_costs {
autotype Real
def cost_growth*monthly_inflation_rate*Cost_Inflation_switch
doc a fraction which stands for the influence of inflation on costs
note Original unit: "dimensionless"
}

aux inflation_rate {
autotype Real
def tariff_growth*monthly_inflation_rate*Present_Tariff_switch
doc Inflation Rate. Not used in this model
}

aux init_actual_tariff {
autotype Real
autounit $/m3
def Tariff
}

const init_CAE {
autotype Real
autounit $
init INIT(CAE_increase/(Recourse_Rate/sum_of_the_people_associated_with_resourses-
Interest_ratio))
}

const init_CWS {
autotype Real
autounit $
12
init INIT(Suspension_Rate*ShortDelayedCredit/((FraudUsersNotPayingBeforeSusp+
NormalUsersNotPayingBeforeSusp)*(Suspension_Rate/(NormSuspUsers+FraudSuspUsers)-
Interest_ratio)))
doc initial value of credits with service suspended
note Original unit: "E"}
```



**Non-Revenue Water Reduction Programs:
Methodology Analysis using a System Dynamics Approach.**

```
const init_ECU {  
autotype Real  
autounit user  
init INIT(WorkforceCapacitySusp*(1-PerctgSUPaying)*TimeRenewContract)  
doc initial people with expired contracts  
note Original unit: "People"  
}  
const init_first_stage {  
autotype Real  
autounit $  
init INIT(NormalPaymentTime*init_revenues)  
doc the initial value of first stage credits  
note Original unit: "E"  
}  
const init_NPU {  
autotype Real  
unit user  
init INIT('Ref Normal Users'-init_NUNP-init_NSU-init_ECU)  
doc initial value of people paying in time  
note Original unit: "People"  
}  
const init_NSU {  
autotype Real  
autounit user  
init INIT(WorkforceCapacitySusp*TimeToExpireContract)  
doc initial people with service suspended  
note Original unit: "People"  
}  
const init_NUNP {  
autotype Real  
autounit user  
init INIT('Ref Normal Users'*iINITPerctgTardyUsers)  
doc initial value of people not paying in time  
note Original unit: "People"  
}
```



Non-Revenue Water Reduction Programs: Methodology Analysis using a System Dynamics Approach.

```
const init_reference_tarif {  
  autotype Real  
  autounit $/m3  
  init INIT(Actual_Tariff)  
  doc tariff. It can be used if tariff is different to the initial tariff. Using demand variations.  
}  
  
const init_revenues {  
  type Real  
  unit $/mo  
  init INIT(init_actual_tariff*'Billed Water Month')  
  doc initial revenues.  
}  
  
const init_SDC {  
  autotype Real  
  autounit $  
  init  
    INIT(((init_revenues*(1-PU_fraction)+Tardy_user_rate* init_revenues * NormalPaymentTime  
    / 'TotalUsers')/(Tardy_user_rate/'UsersNotPayingBefore Susp'-Interest_ratio))  
  doc initial value of short delayed credits  
  note Original unit: "dimensionless"  
}  
  
aux InitClandestineUsers {  
  autotype Real  
  unit user  
  def 0,3*'Ref Fraudulent Users'  
  doc Initial number of clandestines  
}  
  
aux InitFSU {  
  autotype Real  
  unit user  
  def 'Ref Fraudulent Users'*0,3  
  doc Initial number of fraudulent suspended users  
}
```



**Non-Revenue Water Reduction Programs:
Methodology Analysis using a System Dynamics Approach.**

```
aux InitFUNPS {  
  autotype Real  
  unit user  
  def 'Ref Fraudulent Users'*0,2  
  doc Initial number of fraudulent tardy users  
}  
  
aux Initial Income {  
  autotype Real  
  autounit $/mo  
  def INIT(Income)  
  doc Initial cash inn.  
}  
  
aux Initial Outcome {  
  autotype Real  
  autounit $/mo  
  def INIT(Outcome)  
  doc Initial cash out  
}  
  
aux Initial Revenue {  
  autotype Real  
  autounit $/mo  
  def 'Initial Income'-'Initial Outcome'  
  doc Revenues by month  
}  
  
const InitialNumberSuspWorkers {  
  autotype Real  
  unit worker  
  init 13  
  doc Initial number of suspended workers  
}  
  
const InitNPU {  
  autotype Real  
  unit user  
  init 150000  
  doc Initial number of honest paying poeople  
}
```



**Non-Revenue Water Reduction Programs:
Methodology Analysis using a System Dynamics Approach.**

```
const iNITPerctgTardyUsers {  
  autotype Real  
  unit %  
  init 15  
  doc Initial percentage of tardy users  
}  
aux InitPFU {  
  autotype Real  
  unit user  
  def 'Ref Fraudulent Users'*0,2  
  doc Initial number of fraudulent users who are paying to the company.  
}  
aux Inspection on ECU {  
  autotype Real  
  unit user/mo  
  def 0,40*'Delayed Normalized usersmonth'  
  doc Visits per month on expired users  
}  
aux Inspection on FSU {  
  autotype Real  
  unit user/mo  
  def 0,30*'Delayed Normalized usersmonth'  
  doc Visits per month on Suspended Users  
}  
aux Inspection on FUNP {  
  autotype Real  
  unit user/mo  
  def 0,20*'Delayed Normalized usersmonth'  
  doc Visits per month on tardy users  
}  
aux InspectorCosts {  
  autotype Real  
  unit $/mo  
  def NumberInspectorWorkers*ref_normal_salary_per_hour*'Normal Worktime'  
  doc Monthly inspector costs  
}
```



**Non-Revenue Water Reduction Programs:
Methodology Analysis using a System Dynamics Approach.**

```
aux inspectorsneeded {
autotype Real
autounit worker
def ROUND('Budget for UFW'/'unit inspector cost')
doc the number of needed inspectors
}

aux Interest_for_CAE {
autotype Real
autounit $
def Credits_after_expiration*Interest_ratio
doc interest rate associated with credit after expiration
note Original unit: "E/day"
}

aux Interest_for_CWS {
autotype Real
autounit $
def credit_with_suspension*Interest_ratio
doc interest rate associated with CWS( credit with service suspended)
note Original unit: "E/day"
}

aux Interest_for_S_D {
autotype Real
autounit $
def ShortDelayedCredit*Interest_ratio
doc interest rate with short delayed credits
note Original unit: "E/day"
}

aux Interest_ratio {
autotype Real
def (1+AnnualInterestRateOnAR)^(1/12)-1
doc the interest ratio for credited not payed in time
note Original unit: "dimensionless"
}
```



Non-Revenue Water Reduction Programs: Methodology Analysis using a System Dynamics Approach.

```
aux lastmonthrevenue {  
autotype Real  
autounit $  
def DELAYPPL(AccumRevenue;1;AccumRevenue)  
}  
aux losses_on_credits {  
autotype Real  
autounit $/mo  
def credits_write_off  
doc loss generated from the credits written off  
note Original unit: "E/day"  
}  
aux LostMoneyMonth {  
autotype Real  
autounit $/mo  
def 'Non Technical Losses Month'*Tariff  
doc money the company losses because of Non Revenue Water  
}  
aux MaxSuspensionRate {  
autotype Real  
unit user/mo  
def  
NormalUsersNotPayingBeforeSusp*(1-PercUsersPayWithinMinSuspTime)  
/MinimumTimeToSuspend  
doc suspension rate, depending on workforce and time to suspend  
}  
aux MaxSuspTimeFrauders {  
autotype Real  
autounit user/mo  
def  
FraudUsersNotPayingBeforeSusp*(1-  
PercUserPMinSuspTimeFrauders)/MinimumTimeToSuspend  
doc time used to suspend users  
}
```



**Non-Revenue Water Reduction Programs:
Methodology Analysis using a System Dynamics Approach.**

```
const MinimumTimeToSuspend {
autotype Real
unit mo
init 2
doc minimum time to suspend not paying users
}

aux monthhly revenues {
autotype Real
autounit $
def AccumRevenue-lasthmonthrevenue
doc difference in accumulated revenues.
}

aux monthly_inflation_rate {
autotype Real
def (1+yearly_Inflation_Rate)^(1/12)-1
doc monthhly average inflation rate. it was not used at last
note Original unit: "dimensionless"
}

const MonthlyClandIncrease {
autotype Real
unit 1/mo
init 0
doc unit increase rate for clandestine users
}

const MonthlyUserIncrease {
autotype Real
unit 1/mo
init 0
doc unit increase rate for normal users
}

aux neededworkersscn1 {
autotype Real
autounit worker
def IndicatedNumberSuspWokers+inspectorsneeded
}
```



**Non-Revenue Water Reduction Programs:
Methodology Analysis using a System Dynamics Approach.**

```
aux Net_econ_result_from_oper_credits {  
autotype Real  
autounit $  
def tot_intersts_from_credits-Tot_costs_related_to_credits  
doc the new economic value results from the credits collection  
note Original unit: "E/day"  
}  
  
aux Non Technical Losses each Month {  
autotype Real  
unit m3/mo  
dim month  
def FOR(month=1..12|DELAYPPL('Non Technical Losses Month';month))  
doc used to get the non tech. losses in one year  
}  
  
aux Non Technical Losses Month {  
autotype Real  
autounit m3/mo  
def ClandestineUsers*NonBilledWaterClandestine+FraudSuspUsers*NonBilledWaterFSU+  
FraudUsersNotPayingBeforeSusp*NonBilledWaterFUNP+'Paying Fraud  
Users'*NonBilledWaterPFU  
doc water losses per month  
}  
  
aux Non Technical Losses Year {  
autotype Real  
unit m3/yr  
def ARRSUM('Non Technical Losses each Month')/12  
doc water losses per year  
}  
  
aux NonBilledWaterClandestine {  
autotype Real  
autounit m3/(mo*user)  
def Effect_of_tariff_vari_on_nonbilledWaterClandestine*'RefNon billed water Clandestine'  
doc water losses per clandestine user in one month  
}
```



Non-Revenue Water Reduction Programs: Methodology Analysis using a System Dynamics Approach.

```
aux NonBilledWaterFSU {  
  autotype Real  
  autounit m3/(mo*user)  
  def Effect_of_tariff_vari_on_nonbilledWatFSU*'RefNon billed water FSU'  
  doc water losses per fraudulent suspended user in one month  
}  
aux NonBilledWaterFUNP {  
  autotype Real  
  autounit m3/(mo*user)  
  def Effect_of_tariff_vari_on_nonbilledWatFUNP*'RefNon billed water FUNP'  
  doc water losses per fraudulent tardy user in one month  
}  
aux NonBilledWaterPFU {  
  autotype Real  
  autounit m3/(mo*user)  
  def Effect_of_tariff_vari_on_nonbilledWatPFU*'RefNon billed water PFU'  
  doc water losses per paying fraudulent user in one month  
}  
aux Normal Users {  
  autotype Real  
  unit user  
  def NormalUsersNotPayingBeforeSusp+'NormalPaying Users'  
  doc sum of stocks of honest people that are billed  
}  
const Normal Worktime {  
  autotype Real  
  unit hr/mo  
  init 160  
  doc worktime in hours per month  
}  
const Normal_Payment_Time {  
  autotype Real  
  init 45  
  doc normal payment time. Not used, replaced by NormalPaymentTime in months.  
  note Original unit: "days"  
}
```



Non-Revenue Water Reduction Programs: Methodology Analysis using a System Dynamics Approach.

```
aux Normalized Penalty App {  
autotype Real  
def 'Penalty Application %/'/'Reference Penalty Application'  
doc relative penalty application  
}  
aux normalizingClandestine {  
autotype Real  
autounit user/mo  
def MIN(ClandestineUsers/TimetoNormalize;'Inspection on ECU')  
doc flow of normalized clandestines per month  
}  
aux Normalization on PFU {  
autotype Real  
unit user/mo  
def 0,10*'Delayed Normalized usersmonth'  
doc percentage of paying fraudulent users normalized per month  
}  
aux Normalized ObjUFW {  
autotype Real  
def 'abs ObjUFW/'/'Ref ObjUFW'  
doc relative Objective Non Revenue Water (dimensionless)  
}  
aux Normalized Usersmonth {  
autotype Real  
autounit user/mo  
def workforcecapacityInspectors  
doc normalized users per month, depending of workforce capacity  
}  
aux NormalizingFSU {  
autotype Real  
autounit user/mo  
def MIN(FraudSuspUsers/TimetoNormalize;'Inspection on FSU')  
doc flow of fraudulent suspended being normalized  
}
```



**Non-Revenue Water Reduction Programs:
Methodology Analysis using a System Dynamics Approach.**

```
aux normalizingFUNP {  
autotype Real  
autounit user/mo  
def MIN(FraudUsersNotPayingBeforeSusp/TimetoNormalize;'Inspection on FUNP')  
doc flow of fraudulent tardies being normalized  
}  
aux normalizingPFU {  
autotype Real  
autounit user/mo  
def MIN('Paying Fraud Users'/TimetoNormalize;'Normalization on PFU')  
doc flow of paying fraudulent users being normalized  
}  
aux normalpayers {  
autotype Real  
autounit user  
def 'Ref Normal Users'*0,6  
doc reference paying users  
}  
level NormalPaying Users {  
reservoir  
autotype Real  
unit user  
init init_NPU  
outflow { autodef NormalTardyUsersRate }  
inflow { autodef RRbyServiceSusptoNormal }  
inflow { autodef IncreasingRateUsers }  
inflow { autodef RRCfUsersDelayPay }  
inflow { autodef ContractRenewmentRate }  
outflow { autodef NPUtoPFU }  
inflow { autodef PFUtoNPU }  
doc stock of paying users, honest.  
}  
const NormalPaymentTime {  
autotype Real  
unit mo  
init 2
```



**Non-Revenue Water Reduction Programs:
Methodology Analysis using a System Dynamics Approach.**

```
doc time to pay bills
note month
}
aux NormalTardyUsersRate {
autotype Real
unit user/mo
def 'NormalPaying Users'/NormalPaymentTime*perctg_of_Tardy_Users
doc rate of honest people becoming tardy
}
level NormalUsersNotPayingBeforeSusp {
reservoir
autotype Real
unit user
init init_NUNP
inflow { autodef NormalTardyUsersRate }
outflow { autodef SuspRate }
outflow { autodef RRCfUsersDelayPay }
outflow { autodef NUNPtoFUNP }
inflow { autodef FUNPtoNUNP }
doc stock of tardy users being honest
}
level NormSuspUsers {
reservoir
autotype Real
unit user
init init_NSU
inflow { autodef SuspRate }
outflow { autodef ExpiringRateNorm }
outflow { autodef RRbyServiceSusptoNormal }
outflow { autodef NSUtoFSU }
inflow { autodef FSUtoNSU }
inflow { autodef SuspRateFrauders }
doc Normal Suspended Users
}
aux NPUtoPFU {
autotype Real
```



Non-Revenue Water Reduction Programs: Methodology Analysis using a System Dynamics Approach.

```
unit user/mo
def 'fraction of NPU tempted to fraud'/TimeCommitFraud
doc Normal Paying Users which turn into Paying Fraudulent Users
}
aux NSUtoFSU {
autotype Real
autounit user/mo
def 'fraction of NSU tempted to fraud'/timecommitfraud2
doc Normal Suspended Users turning into Fraudulent Suspended Users
}
aux NumberInspectorWorkers {
autotype Real
unit worker
def IF((TotNumberWorkers-NumberSuspensionWorkers)<0<<worker>>;0<<worker>>;
(TotNumberWorkers-NumberSuspensionWorkers))
doc number of inspection workers. When inspector workers are needed, it takes time to hire
them.
}
aux NumberSuspensionWorkers {
autotype Real
unit worker/mo
def
DELAYINF(WorkingIndSuspWorkers;TimeChangeSuspWorkers;1;InitialNumberSuspWorkers)
doc number of suspension workers, having hiring delays into account.
}
aux NUNPtoFUNP {
autotype Real
autounit user/mo
def 'fraction of NUNP tempted to fraud'/TimeCommitFraud
doc Normal Users Non Paying Before Suspension turning into Fraudulent Users Non Paying
}
```



Non-Revenue Water Reduction Programs:

Methodology Analysis using a System Dynamics Approach.

aux ObjLossesMonth {

autotype Real

autounit m3/mo

def

MAX('Non Technical Losses Month'-DELAYINF(GoalLossesMonth;6;1;GoalLossesMonth);0
<<m3/mo>>)

doc Objective Water Loss, the difference between simulated losses and goal losses (taken from Goal NRW index)

}

aux ObjUFW {

autotype Real

unit %

def UFW - DELAYINF(GoalUFW;6;1;GoalUFW)

doc Objective Non Revenue Water: Difference between the Non Revenue Water Index and the Goal Non Revenue Water, that is determined from the very start of the simulation. It has 6 months delay

}

aux Operating_Profit {

autotype Real

autounit \$/mo

def Gross_margin+Net_econ_result_from_oper_credits

doc The company's operating profits. Taken from Amap.

note Original unit: "E/days"

}

const Other Sectors Billed Water Month {

autotype Real

init 350000000

doc Billed Water in Commercial, Industrial and other sectors. Although it was intended to be used in this

model, I finally discard this to work only with commercial losses

}

aux Outcome {

autotype Real

autounit \$/mo

def 'Budget for UFW'+LostMoneyMonth+Tot_WF_Costs

doc Expenses per month}



**Non-Revenue Water Reduction Programs:
Methodology Analysis using a System Dynamics Approach.**

```
level Paying Fraud Users {  
reservoir  
autotype Real  
unit user  
init InitPFU  
outflow { autodef FraudTardyUsersRate }  
inflow { autodef NPUtoPFU }  
outflow { autodef PFUtoNPU }  
inflow { autodef RRCfUsersDelayPayFrauders }  
inflow { autodef RRbyServiceSusptoFrauders }  
doc Stock of Paying Fraud Users  
}  
const penalized period {  
autotype Real  
unit mo  
init 10  
doc It is assumed 10 months.  
}  
aux Penalty Application % {  
autotype Real  
def 0,95  
doc Almost all the normalizations have an associated penalty  
}  
aux Penalty Cost Clandestine {  
autotype Real  
unit $/mo/user  
def 'penalized period'*Tariff*NonBilledWaterClandestine  
doc Cost of committing crime in clandestines  
}  
aux Penalty Cost Fraud Tardy Users FUNP {  
autotype Real  
unit $/mo/user  
def 'penalized period'*Tariff*NonBilledWaterFUNP  
doc fee value, depends on tariff, and penalized period  
note In Colombia, practices like tampering or taking water without paying is fraud, but there  
is no clarity about how many months should be considered as penalized period.}
```



**Non-Revenue Water Reduction Programs:
Methodology Analysis using a System Dynamics Approach.**

```
aux Penalty Cost FSU {
autotype Real
unit $/mo/user
def 'penalized period'*Tariff*NonBilledWaterFSU
doc Penalty cost perceived by Fraudulent Suspended Users
}

aux Penalty Cost PFU {
autotype Real
unit $/mo/user
def 'penalized period'*Tariff*NonBilledWaterPFU
doc Penalty cost perceived by Fraudulent Paying User
}

aux People_not_payng_before_suspension {
autotype Real
autounit user
def FraudUsersNotPayingBeforeSusp+NormalUsersNotPayingBeforeSusp
doc people not paying in time: includes honest and fraudulent users
note Original unit: "People"
}

aux perceived difincome {
autotype Real
autounit $/mo
def DELAYPPL('difIncome-out';1;'difIncome-out')
doc auxiliar variable to calculate monthly revenues
}

aux Perceived Fraud Costs Expired Users ECU {
autotype Real
unit $/mo/user
def 'Effect of Normalizing Expired Users'*'Effect of penalty application on Perceived Costs for
ECU
users'*'Penalty Cost Clandestine'
doc perceived costs of committing fraud perceived by users.
}
```



**Non-Revenue Water Reduction Programs:
Methodology Analysis using a System Dynamics Approach.**

```
aux Perceived Fraud Costs paying users {
autotype Real
unit $/mo/user
def 'Penalty Cost PFU'*'Effect of Normalization on paying Users'*'Effect of penalty application
on
Perceived Costs for paying users'
doc perceived costs of committing fraud perceived by users.
}

aux Perceived Fraud Costs Suspended Users {
autotype Real
unit $/mo/user
def 'Penalty Cost FSU'*'Effect of Inspection on Susoended Users'*'Effect of penalty
application on
Perceived Costs for Suspended users'
doc perceived costs of committing fraud perceived by users.
}

aux Perceived Fraud Costs Tardy Users {
autotype Real
unit $/mo/user
def 'Effect of Inspection on tardy Users'*'Effect of penalty application on Perceived Costs for
tardy
users'*'Penalty Cost Fraud Tardy Users FUNP'
doc perceived costs of committing fraud perceived by users.
}

aux Perceived_tariff_variation {
autotype Real
def DELAYINF(yearly_tarif_variation; 360; 1;0)
doc The perceived tariff variation by the customer.
}

aux percentage_of_bad_credits_collection {
autotype Real
def refernce_prcntg_of_BC_collection*Effect_of_suspnsn_time_on_bad_crdts
doc bad credit collection percentage (dimensionless here). Taken from AMAP
note dimensionless
}
```



**Non-Revenue Water Reduction Programs:
Methodology Analysis using a System Dynamics Approach.**

```
const PercFSUpaying {  
  autotype Real  
  unit %  
  init 90  
}  
  
const perctg_of_Tardy_Users {  
  autotype Real  
  init INIT((WorkforceCapacitySusp+init_NUNP*PercUsersPayWithinMinSuspTime/  
  MinimumTimeToSuspend)*NormalPaymentTime/init_NPU)  
  doc percentage of people delaying to pay  
  note Original unit: "dimensionless"  
}  
  
const PerctgFraudTardyUsers {  
  autotype Real  
  unit %  
  init 10  
  doc Percentage of tardy users, fraudulent  
}  
  
const PerctgSUpaying {  
  autotype Real  
  unit %  
  init 75  
  doc Percentage of suspended users who pay again their debts  
}  
  
const PercUserPMinSuspTimeFrauders {  
  autotype Real  
  unit %  
  init 15  
  doc Percentage of tardies who pay again their bills  
}  
  
const PercUsersPayWithinMinSuspTime {  
  autotype Real  
  unit %  
  init 15  
  doc Percentage of tardies who pay again their bills  
}
```



**Non-Revenue Water Reduction Programs:
Methodology Analysis using a System Dynamics Approach.**

```
aux PFUtoNPU {  
autotype Real  
unit user/mo  
def IF('Paying Fraud Users'>0<<user>>;'fraction of FPU thinking to stop  
frauding'/timenormalizePFU+ normalizingPFU;0<<user/mo>>)  
doc flow of people: from paying fraudulent users to honest paying users  
}  
const PrctgUsersPayWithinSuspTime {  
autotype Real  
unit %  
init 15  
doc percentage of tardy users paying  
}  
const PrctgUsersPayWithinSuspTimeFrauders {  
autotype Real  
unit %  
init 25  
doc Percentage of fraudulent tardies paying  
}  
const Present_Tariff_switch {  
autotype Real  
init 0  
doc Not Used in the model: if tariff considers inflation, this switch will become One.  
}  
aux Previous UFW {  
autotype Real  
autounit %  
def DELAYPPL(UFW;1;UFW)  
doc Non Revenue Water from the month before  
}  
const ProductivityInspectors {  
autotype Real  
unit user/worker/mo  
init 50  
doc number of users visited by an inspector in 1 month  
}
```



Non-Revenue Water Reduction Programs: Methodology Analysis using a System Dynamics Approach.

```
const ProductivitySusp {
autotype Real
unit user/worker/mo
init 100
doc how many users can be suspended by a suspension worker in one month
}

aux PU_fraction {
autotype Real
def ('NormalPaying Users'+ 'Paying Fraud Users')/'Total Users'
doc the fraction of paying people in total population
note Original unit: "dimensionless"
}

aux real Suspended-Users {
autotype Real
autounit user
def ExpiredContractsUsers+NormSuspUsers
doc Numer of users who are without water service
}

aux Real UFW {
autotype Real
unit %
def
GRAPH(TIME;STARTTIME;Timestep;{23,08;24;25;25,1;23,5;25;25,34;25,94;25,94;25,93;25
,26;24,26;25,12;24,74;25,31;24,28;23,20;23,65;23,73;23,20;23,65;23,73;24,13;23,94;23,81;
24,32;23,81;24,32;25,05;25,27;24,21;25,74;25,77;25,04;24,70;23,46//Min:0;Max:1//}<<%
>>)
doc Non Revenue Water Index (real between 2003 and 2005)
}

aux real_payment_time {
type Real
def total_credits/Revenues
doc real payment time. Not used finally
note Original unit: "days"
}
```



**Non-Revenue Water Reduction Programs:
Methodology Analysis using a System Dynamics Approach.**

```
aux RealTimeSuspend {
autotype Real
autounit mo
def NormalUsersNotPayingBeforeSusp*(1-PercUsersPayWithinMinSuspTime)/SuspRate
doc Time to suspend the service
}

aux Recourse_Rate {
autotype Real
autounit user/mo
def (Backoffice_workload)/Time_to_analyse_a_recourse
doc recouse rate associated with people
note Original unit: "People/day"
}

const Ref Avg Billed Water Normal User {
autotype Real
unit m3/mo/user
init 25
doc Date by the end of year 2002
}

aux Ref Budget for UFW {
autotype Real
unit $/mo
def 10000000
doc Budget used in Water Loss Reduction Programs
}

aux Ref Fraudulent Users {
autotype Real
unit user
def Ref_Commercial_losses_Month/'RefNon Billed Water Fraudulent Users'
doc reference number of fraudulent users.
}

const Ref Losses Year {
autotype Real
unit m3/yr
init 21747873,5
doc The reference value of water lost in the year 2003 in the Zone 4.}
```



**Non-Revenue Water Reduction Programs:
Methodology Analysis using a System Dynamics Approach.**

```
aux Ref Normal Users {  
  autotype Real  
  unit user  
  def 'REfnormalBilled Water Month'/'Ref Avg Billed Water Normal User'  
  doc reference number of honest users  
}  
aux Ref ObjUFW {  
  autotype Real  
  unit %  
  def 100  
  doc Used to calcule relative Objective Non Revenue Water  
}  
aux Ref Total Users {  
  autotype Real  
  unit user  
  def 'Ref Fraudulent Users'+ 'Ref Normal Users'  
  doc reference users. Model Input.  
}  
const Ref UFW {  
  autotype Real  
  unit %  
  init 23,08  
  doc The reference value for the unaccounted-for water. It is taken from "facturacion  
  suministro v2.xls" which is the relation between billed m3 and distributed m3 in EPM from  
  january 2003 until december 2005.  
}  
const ref_avrg_monthly_salary_per_person {  
  autotype Real  
  unit $/mo/worker  
  init 500000  
  doc reference daily labor cost of service suspension  
  note Original unit: "E/day/person"  
}
```



Non-Revenue Water Reduction Programs:

Methodology Analysis using a System Dynamics Approach.

```
aux Ref_Billed_Water_Month {
autotype Real
autounit m3/mo
def Ref_Distributed_Water_Month-Ref_Total_Losses_Month
doc all billed water by month
}

aux Ref_Commercial_losses_Month {
autotype Real
autounit m3/mo
def Ref_Total_Losses_Month
doc reference water loss in one month
}

aux Ref_Distributed_Water_per_Year {
autotype Real
unit m3/yr
def 'Ref Losses Year'/'Ref UFW'
doc reference distributed water in one year
}

aux Ref_Distributed_Water_Month {
autotype Real
unit m3/mo
def 'Ref_Distributed_Water_per_Year'
doc Reference distributed water by month
}

const ref_normal_salary_per_hour {
autotype Real
unit $/hr/worker
init 5000
doc hourly personally reference labor cost for normal working time
}

aux Ref_Total_Losses_Month {
autotype Real
unit m3/mo
def 'Ref Losses Year'
doc reference total losses in one month
}
```



Non-Revenue Water Reduction Programs:

Methodology Analysis using a System Dynamics Approach.

```
const RefAvg Billed Water per Fraudulent User {
autotype Real
unit m3/mo/user
init 15
doc average water billed per fraudulent user. Reference data
}

aux RefBilled Water Fraudulent Users Month {
autotype Real
autounit m3/mo
def RefFractionPayingFraudUsers*'Ref Fraudulent Users'*RefAvg Billed Water per Fraudulent
User'
doc the reference billed water in fraudulent users.
}

const Reference Fraud Attractiveness {
autotype Real
init 1
doc reference data to be used in relative attractiveness variable.
note dimensionless
}

const Reference normalization Users {
autotype Real
unit user/mo
init 15
doc average user normalization done by one inspector in one month. This value is assumed
to be the same for the different types of users: paying on time, tardies, suspended and
expired.
}

const Reference Penalty Application {
autotype Real
init 1
doc 1 means that penalty is applied when normalization occurs.
}

aux reference_tarif {
autotype Real
autounit $/m3
def init_reference_tarif*cost_growth
```



Non-Revenue Water Reduction Programs: Methodology Analysis using a System Dynamics Approach.

```
doc Reference Tariff. In this case is the same tariff
}
const refernce_prcntg_of_BC_collection {
autotype Real
init ,80
doc Bad Credit Collection
}
const RefFractionPayingFraudUsers {
autotype Real
unit %
init 70
doc Fraction of fraudulent users paying on time
}
const RefNon billed water Clandestine {
autotype Real
unit m3/mo/user
init 35
doc Non Billed Water by Clandestine users (reference data)
}
const RefNon Billed Water Fraudulent Users {
autotype Real
unit m3/mo/user
init 26,5
doc Fraudulent User Non Billed Water (reference data)
}
const RefNon billed water FSU {
autotype Real
unit m3/mo/user
init 30
doc Non Billed Water by Fraudulent Suspended Users (reference data)
}
const RefNon billed water FUNP {
autotype Real
unit m3/mo/user
init 15
doc Reference Non Billed Water by fraudulent Tardy users}
```



**Non-Revenue Water Reduction Programs:
Methodology Analysis using a System Dynamics Approach.**

```
const RefNon billed water PFU {  
autotype Real  
unit m3/mo/user  
init 15  
doc Reference Non Billed Water by fraudulent paying users  
}  
aux REfnormalBilled Water Month {  
autotype Real  
autounit m3/mo  
def Ref_Billed_Water_Month-'RefBilled Water Fraudulent Users Month'  
doc Billed Water by honest people  
}  
aux Relative Fraud Attractiveness ECU and Clandestne {  
autotype Real  
def 'Fraud Attractiveness ECU'/'Reference Fraud Attractiveness'  
doc Relative Fraud Attractiveness in expired and clandestine users  
}  
aux Relative Fraud Attractiveness paying users {  
autotype Real  
def 'Fraud Attractiveness paying users'/'Reference Fraud Attractiveness'  
doc Attractiveness in paying users  
}  
aux Relative Fraud Attractiveness Suspended {  
autotype Real  
def 'Fraud Attractiveness Suspended Users'/'Reference Fraud Attractiveness'  
doc Fraud Attractiveness in suspended users  
}  
aux Relative Fraud Attractiveness Tardy Users {  
autotype Real  
def 'Fraud Attractiveness Tardy Users'/'Reference Fraud Attractiveness'  
doc Fraud Attractiveness in Tardy Users  
}
```



**Non-Revenue Water Reduction Programs:
Methodology Analysis using a System Dynamics Approach.**

aux Relative Normalization Clandestine {

autotype Real

def 'Inspection on ECU'/'Reference normalization Users'

doc Relative Normalization In Clandestines to be used in perceived fraud costs

}

aux Relative Normalization FSU {

autotype Real

def 'Inspection on FSU'/'Reference normalization Users'

doc Relative Normalization In Fraudulent Suspended Users to be used in perceived fraud costs

}

aux Relative Normalization FUNP {

autotype Real

def 'Inspection on FUNP'/'Reference normalization Users'

doc Relative Normalization In Fraudulent Tardy Users to be used in perceived fraud costs

}

aux Relative Normalization PFU {

autotype Real

def 'Normalization on PFU'/'Reference normalization Users'

doc Relative Normalization In Fraudulent Paying Users to be used in perceived fraud costs

}

aux requiredNumberInspectors {

autotype Real

autounit worker

def ROUND(avgFraudUsersperMonth/ProductivityInspectors)

doc required number of inspectors, to achieve ObjNRW needs

}

aux requiredNumberWorkers {

autotype Real

autounit worker

def IndicatedNumberSuspWokers+requiredNumberInspectors

doc Required number of total workers

}



**Non-Revenue Water Reduction Programs:
Methodology Analysis using a System Dynamics Approach.**

```
aux Revenues {
autotype Real
autounit $/mo
def Tot_counted_water*Actual_Tariff
doc The revenues of the company for the water service. Taken from Amap model
note Original unit: "E/days"
}

aux RR_by_Service_suspension {
autotype Real
autounit user/mo
def RRbyServiceSusptoFrauders+RrbyServiceSusptoNormal
doc paying rate generated by service suspension. Taken from Amap Model
note Original unit: "People/day"
}

aux RR_of_people_delay_to_pay {
autotype Real
autounit user/mo
def RRCfUsersDelayPay+RRCfUsersDelayPayFrauders
doc paying rate within the minimum time to suspend the service
note Original unit: "People/day"
}

aux RRbyServiceSusptoFrauders {
autotype Real
autounit user/mo
def
IF(FraudSuspUsers>0<<user>>;FraudSuspUsers*PercFSUpaying/TimeToExpireContract;0<<
user/mo>>)
doc From AMAP, adapted to fraudulent users
}

aux RRbyServiceSusptoNormal {
autotype Real
unit user/mo
def PercTgSUpaying*NormSuspUsers/TimeToExpireContract
doc From AMAP, adapted to normal users
}
```



**Non-Revenue Water Reduction Programs:
Methodology Analysis using a System Dynamics Approach.**

```
aux RRCfUsersDelayPay {
autotype Real
unit user/mo
def
PrctgUsersPayWithinSuspTime*NormalUsersNotPayingBeforeSusp/MinimumTimeToSuspend
doc From AMAP, adapted to honest users
}

aux RRCfUsersDelayPayFrauders {
autotype Real
autounit user/mo
def
FraudUsersNotPayingBeforeSusp*PrctgUsersPayWithinSuspTimeFrauders/MinimumTimeToSuspend
doc From AMAP, adapted to fraudulents
}

aux SDcreditIncrease {
autotype Real
autounit $/mo
def (first_stage_credit/NormalPaymentTime)-Credits_payments_in_time
doc increase rate of SD credit, after normal payment time, the credit still not payed flows
from the first stage credit to the short delayed credits
note Original unit: "E/day". See Amap model
}

aux SDcreditspayment {
autotype Real
autounit $/mo
def RR_of_people_delay_to_pay*unit_delayed_credits_per_people_not_pay
doc the payment rate after the notice of sevice suspension
note Original unit: "E/day". From Amap model.
}

level ShortDelayedCredit {
autotype Real
autounit $
init init_SDC
inflow { autodef Interest_for_S_D }
inflow { autodef SDcreditIncrease }
```



Non-Revenue Water Reduction Programs:

Methodology Analysis using a System Dynamics Approach.

```
outflow { autodef SDcreditspayment }
outflow { autodef CWS_increase }
doc credits with short delay. Taken from Amap model.
note Original unit: "E"
}
aux sum_of_the_people_associated_with_resources {
autotype Real
autounit user
def ExpiredContractsUsers+UserRecourseProcess+ClandestineUsers
}
aux SuspendedUsers {
autotype Real
autounit user
def FraudSuspUsers+NormSuspUsers
doc people with water service suspended
note Original unit: "People"
}
aux Suspension_Rate {
autotype Real
autounit user/mo
def SuspRate+SuspRateFrauders
doc suspension rate for both fraudulent and honest
note Original unit: "People/day"
}
aux suspension_worker_labor_costs {
autotype Real
autounit $/mo
def EffectiveNumberSuspWorkers*avrg_daily_salary_per_person
doc the labor cost of service suspension
note Original unit: "E/day"
}
aux SuspRate {
autotype Real
unit user/mo
def MIN(MaxSuspensionRate;WorkforceCapacitySusp)
}
```



**Non-Revenue Water Reduction Programs:
Methodology Analysis using a System Dynamics Approach.**

```
aux SuspRateFrauders {  
autotype Real  
autounit user/mo  
def MIN(MaxSuspTimeFrauders;WorkforceCapacitySusp)  
}  
aux SuspWorkPressure {  
autotype Real  
def  
IF(RealTimeSuspend=11000;1;(RealTimeSuspend-MinimumTimeToSuspend)/  
RealTimeSuspend)  
doc work pressure of service suspension  
note Original unit: "dimensionless"- From Amap  
}  
aux Tardy_user_rate {  
autotype Real  
autounit user/mo  
def FraudTardyUsersRate+NormalTardyUsersRate  
doc . this tardy rate includes honest and fraudulent tardy users. It seems that Gianni  
Montemaggiore or Gefei Lu took this coflow from Sterman Business Dynamics Chapter 9.  
note Original unit: "People/day". From Amap.  
}  
const Tariff {  
autotype Real  
unit $/m3  
init 30  
doc Initial tariff  
}  
level tariff_growth {  
autotype Real  
init 1  
inflow { autodef inflation_rate }  
doc if there is inflation,this stock of tariff growth is used.  
}
```



**Non-Revenue Water Reduction Programs:
Methodology Analysis using a System Dynamics Approach.**

```
const Time_to_analyse_a_recourse {  
autotype Real  
unit mo  
init 3  
doc time spent by lawyers in back office to analyse a recourse.  
note Original unit: "day"  
}  
const Time_to_settle_recourses {  
autotype Real  
28  
init 540  
doc time to settle resourses  
note Original unit: "days"  
}  
const TimeChangeSuspWorkers {  
autotype Real  
unit mo  
init 1  
doc time to change suspended workers.  
}  
const TimeCommitFraud {  
autotype Real  
unit mo  
init 3  
doc time to commit fraud  
}  
const timecommitfraud2 {  
autotype Real  
unit mo  
init 2  
doc time to commit fraud. Two types are used to differentiate fraud in paying users and  
fraud in clandestine and suspended.  
}
```



**Non-Revenue Water Reduction Programs:
Methodology Analysis using a System Dynamics Approach.**

```
const TimeHireWorker {  
  autotype Real  
  unit mo  
  init 2  
  doc time to hire workers in months  
}  
const timeInterv {  
  autotype Real  
  unit mo  
  init 1  
  doc time of user inspection (month)  
}  
const TimeLayOff {  
  autotype Real  
  unit mo  
  init 2  
  doc time to lay off workers in months  
}  
const timenormalizePFU {  
  autotype Real  
  unit mo  
  init 4  
  doc time in normalizing a Paying Fraud User. months.  
}  
const TimeRenewContract {  
  autotype Real  
  unit mo  
  init 1  
  doc time to reconnect legally to the network  
}  
const TimeToBeProductive {  
  autotype Real  
  unit mo  
  init 2  
  doc the time for a new worker turning into a proficient worker.  
}
```



**Non-Revenue Water Reduction Programs:
Methodology Analysis using a System Dynamics Approach.**

```
const TimeToExpireContract {
autotype Real
unit mo
init 4
doc Time in which 1 suspended users is disconnected or expired
}

const TimeToIllegReconnect {
autotype Real
unit mo
init 2
doc Time to reconnect illegally to the network in months
}

const TimetoNormalize {
autotype Real
unit mo
init 3
doc time to normalize fraudulent users in months
}

const TimeToRetire {
autotype Real
unit mo
init 12
doc time to retire in months for workers
}

aux Tot_costs_related_to_credits {
autotype Real
unit $/mo
def losses_on_credits+suspension_worker_labor_costs
doc total costs related to credits collection
note Original unit: "E/day", taken from Amap model
}
```



Non-Revenue Water Reduction Programs:

Methodology Analysis using a System Dynamics Approach.

```
aux Tot_counted_water {
autotype Real
autounit m3/mo
def 'Billed Water Month'
doc The net flow of billed water.
note Original unit: "m3/day"
}

aux tot_intersts_from_credits {
autotype Real
autounit $
def Interest_for_CAE+Interest_for_CWS+Interest_for_S_D
doc total interest generated by the credits without payed in time
note Original unit: "E/day"
}

aux Tot_WF_Costs {
autotype Real
autounit $/mo
def suspension_worker_labor_costs+InspectorCosts
doc total labor costs, including the inspection labor cost and the service suspension labor
cost
note Original unit: "E/day"
}

aux Total Users {
autotype Real
unit user
def ExpiredContractsUsers+FraudUsersNotPayingBeforeSusp+'NormalPaying Users'+
NormalUsersNotPayingBeforeSusp+'Paying Fraud Users'+NormSuspUsers+FraudSuspUsers+
ClandestineUsers
doc Sum of all stocks of users. Fraudulent plus normal users
}

aux total_credits {
autotype Real
autounit $
def
credit_with_suspension+Credits_after_expiration+credits_written_off+first_stage_credit+
ShortDelayedCredit
```



Non-Revenue Water Reduction Programs: Methodology Analysis using a System Dynamics Approach.

doc The total amount of credits of the company.

note Original unit: "E"

}

aux TotHiringRate {

autotype Real

unit worker/mo

def

(MAX((neededworkersscn1-TotNumberWorkers)/TimeHireWorker;0<<worker/mo>>)
+TotRetirRate)

doc Hiring Rate in EPM

}

aux totLayOffRate {

autotype Real

unit worker/mo

def ABS(MIN((neededworkersscn1-TotNumberWorkers)/TimeLayOff;0<<worker/mo>>))

doc Lay Off Rate in EPM

}

level TotNumberWorkers {

autotype Real

unit worker

init DecidedNumberWorkers

inflow { **autodef** TotHiringRate }

outflow { **autodef** TotRetirRate }

outflow { **autodef** totLayOffRate }

doc stock of workers: inspectors and suspension workers

}

aux TotRetirRate {

autotype Real

autounit worker/mo

def TotNumberWorkers/TimeToRetire

doc Retire Rate in EPM

}



**Non-Revenue Water Reduction Programs:
Methodology Analysis using a System Dynamics Approach.**

```
aux UFW {
autotype Real
unit %
def (('Non Technical Losses Year')/'Distributed Water Year')
doc Simulated Non Revenue Water
}

aux unit inspector cost {
autotype Real
autounit $(mo*worker)
def 'Normal Worktime'*ref_normal_salary_per_hour
doc unit cost in inspector workers
}

aux Unit_credit_increase_per_person {
autotype Real
autounit $/user
def first_stage_credit/'Total Users'
doc FROM AMAP_:_average first stage credit per served population
note Original unit: "E/People"
}

aux unit_credit_with_people_in_recourse_process {
autotype Real
autounit $/user
def Credits_after_expiration DIVZO ((ClandestineUsers+ExpiredContractsUsers)+
UserRecourseProcess)
doc average credit after expiration per person with expired contract
note Original unit: "E/People"
}

aux Unit_credit_with_suspended_people {
autotype Real
autounit $/user
def credit_with_suspension DIVZO (SuspendedUsers)
doc average credit with service suspended per person with service suspended
note Original unit: "E/People"
}
```



**Non-Revenue Water Reduction Programs:
Methodology Analysis using a System Dynamics Approach.**

```
aux unit_delayed_credits_per_people_not_pay {
autotype Real
autounit $/user
def ShortDelayedCredit DIVZO (People_not_payng_before_suspension)
doc average short delayed credits per person who doesn't pay before suspension
note Original unit: "E/People". From Amap.
}

level UserRecourseProcess {
autotype Real
autounit user/mo
init Recourse_Rate*Time_to_settle_recourses
outflow { autodef bad_credits_write_off }
outflow { autodef bad_credits_collection }
inflow { autodef Recourse_Rate }
doc people in the recourse process
note Original unit: "People"
}

aux UsersNotPayingBefore Susp {
autotype Real
autounit user
def FraudUsersNotPayingBeforeSusp+NormalUsersNotPayingBeforeSusp
doc Both fraudulent and normal users which have not payed and they are not suspended yet
}

aux workforcecapacityInspectors {
autotype Real
autounit user/mo
def EffectiveNumberInspectors*ProductivityInspectors*effInspectors
}

aux WorkforceCapacitySusp {
autotype Real
unit user/mo
def EffectiveNumberSuspWorkers*ProductivitySusp
doc workforce capacity to suspend users. How many users can be suspended with this
workforce
}
```



**Non-Revenue Water Reduction Programs:
Methodology Analysis using a System Dynamics Approach.**

```
aux WorkingIndSuspWorkers {
autotype Real
unit worker
def MIN(TotNumberWorkers;IndicatedNumberSuspWokers)
doc Indicated number of suspended workers
}

const yearly_Inflation_Rate {
autotype Real
init 0,018
doc inflation in one year. not used in this model.
}

aux yearly_tarif_variation {
autotype Real
def (Actual_Tariff-reference_tarif)/reference_tarif
doc variation of tariff per year...not used
}

range month {
def 1..12
}

range pipeline {
def 1..3
}

unit $ {
def ATOMIC
}

unit m3 {
def ATOMIC
}

unit user {
def ATOMIC
}

unit worker {
def ATOMIC
}
```



**Non-Revenue Water Reduction Programs:
Methodology Analysis using a System Dynamics Approach.**

**APPENDIX 2.
DATA COLLECTION**

Data collection was one of the most critical points while making this research and although people from EPM Bogotá Aguas E.S.P kindly shared strategic information due to their interest on water loss reduction, there was not a formal contract and no work affiliation between the author of this work and the company.

Group Meetings took place in december 2005 and november 2006 in Bogotá, Colombia. There were phone meetings during 2007 as well, and they were intended to resolve specific questions and request for data. Information was obtained in form of spread sheets, presentations, databases and documents.

The language of this information is spanish, therefore it does not appear here as appendix on this document, but it can be found on the cd which is attached to this thesis. The folder "data" includes data which has been used here. Also there were other sources of information like regulations, laws and financial reports that can be accessed through internet.

In order to separate information provided by EPM and other sources, folders like "EPM" and "diverse" were created. "EPM" folder has all data from the Water Utility and "diverse" from other sources (Colombian Water Regulator, Financial Reports, etc).

In table A2-1, information files by EPM are listed and described. Other files from information outside EPM can be seen at table A2-2.⁵⁰

⁵⁰ These files are provided here as attachments because they are not available for reading or downloading from internet pages or journals.



**Non-Revenue Water Reduction Programs:
Methodology Analysis using a System Dynamics Approach.**

File name	Description
InspectionMay06.xls	Inspectors, Productivity and Efficiency (Sep 05-May 06).
InformePANC_Z4_V2005_5.doc	Water Loss Reduction Plan 2003 – 2007. 2005 Report.
UFW-November2005.xls	Non Revenue Water Analysis from november 2005
Inspections.ppt	Suspension and Inspection Plans. 2006.
Volumendefraudacion.doc	Water Consumption to be charged in frauds.
Plan de Perdidas Comerciales.doc	Non Technical Water Losses Reduction Plan. 2005 Report
SIWI-abstract.doc	Zuleta F., Montoya, M., Yepes L. "Comercial Losses by Illegal Users, a primary component of water losses on developing countries. The Colombian Case." 2004

Table A2.1 EPM Files Description.

File name	Description
EPM Bogota Aguas_2003-11.pdf	Financial Report. EPM Bogotá Aguas 2003 by BRC Investor Services
EPM Aguas_2004-12.pdf	Financial Report. EPM Bogotá Aguas 2004 by BRC Investor Services
EPMBogotaAguas_2005-12.pdf	Financial Report. EPM Bogotá Aguas 2005 by BRC Investor Services
EPMBogotaAguas_2007-01.pdf	Financial Report. EPM Bogotá Aguas 2006 by BRC Investor Services
EPM-INF-2005-0020.pdf	Water Demand Study. Bogotá Water Utility. 2005.
EAAB-BRC2007.pdf	Financial Report. Bogotá Water Utility. 2007 by BRC Investor Services

Table A2.2 Other Data Files Description.



**Non-Revenue Water Reduction Programs:
Methodology Analysis using a System Dynamics Approach.**

**APPENDIX 3
MODEL FILES DESCRIPTION**

The following table includes the model files in powersim, used in this thesis. All of them were made with Powersim Studio 2005. They can be found inside "model" folder.

File name	Description
Epm-2008-refmode.sip	Model with reference behavior.
Epm-2008-policies.sip	Model with policies
Epm-2008-extreme.sip	Model with extreme condition tests
Epm-2008-sensianalysis.sip	Model with sensitivity Analysis

Table A3.1 Files Description.