

Prison Overcrowding: Finding Successful Policies to Manage Capacity Utilization.

Richard McDowall

Submitted in Partial Fulfillment of the Requirements for the Degree
of Master of Philosophy in System Dynamics



System Dynamics Group
Geography Department
UNIVERSITY OF BERGEN
BERGEN
NORWAY

June, 2010

Contents

List of Figures	4
Abstract	6
Acknowledgements.....	7
Literature review	10
Statements in the media and political reports	10
Academic Analysis	12
Modeling and system dynamics.....	15
Summary.....	16
The Dynamic Problem	17
Existing Policy Approaches.....	18
Hypothesis	19
Hypothesis overview	19
Causal loop diagram: Prison Capacity.....	20
Causal loop diagram: Prisoner population.....	21
Causal loop diagram: Imprisonment Probability and Probation Population	24
Causal loop diagram: Probation Capacity	24
Model Structure	26
The Model Boundary.....	27
Time Horizon.....	28
The Stock and Flow Structures.....	28
The framework of attitudes to punishment.....	28
The Offender Population Framework.....	30
Serious and non serious offenders.....	31
Parole.....	32
Probation	33
Recidivism.....	33
Prison Capacity Model	37
Probation Capacity Model	38
Summary.....	39
Analysis	40
Direct Structure Test.....	40
Structure orientated behavior tests.....	41
Equilibrium shock test.....	41
Testing table functions.....	57
Integration method and Choice of DT	61
Recreating the reference mode	61
Policy	66

Policy testing	69
Scenario Tests.....	73
Other potential policies.....	77
Conclusions from policy testing	77
Conclusion	79
Appendix 1: Equations	81
Appendix 2: Full Causal Loop Diagram.....	90
Appendix 3: First Offender Inflow	91
Appendix 4: Extreme Condition Test.....	91
Appendix 7: The Publicity Policy: Scenario Testing.....	95
Appendix 8: Guide to the Control Screen of the model	98
Appendix 9: A very basic model guide	99
References.....	100

List of Figures

Figure 1: Prison Population, Capacity and Overcrowding from 1988 to 2008.	17
Figure 2: Significant legislation and events affecting population development.....	18
Figure 3: Subsystem diagram	20
Figure 4: The main factors affecting prison capacity utilization.	21
Figure 5: Prison capacity: feedback loop B1	21
Figure 6: Sentence Length Feedbacks (balancing feedback loop R1 and B2)	22
Figure 7: Rehabilitation and the punitive drift: Feedback loops R2, B3, and B4.....	23
Figure 8: Judicial punitiveness: Causal Loops R3 and B6	23
Figure 9: Diversion strategy: Causal loops B6, and R4, R5, R6	24
Figure 10: Probation Capacity Loops R7 and B7	25
Figure 11: The public perception of crime	29
Figure 12: Public and Political Attitudes to Punishment.....	29
Figure 13: Judicial Attitudes	30
Figure 14: Offender Population: Stock and Flow structure	31
Figure 15: Prison population: Stock and Flow structure	32
Figure 16: Parole population: Stock and Flow structure	32
Figure 17: Probation population: Stock and Flow structure	33
Figure 18: Rehabilitation	34
Figure 19: Recidivism reduction.....	34
Figure 20: Experienced Capacity Utilization.....	35
Figure 21: Probation recidivism	36
Figure 22: Effect of Worker to Offender Ratio on Recidivism	37
Figure 23: Simple Prison Capacity Structure	37
Figure 24: Full Stock and Flow Structure: Prison Capacity	38
Figure 25: Simple Stock and Flow Structure: Probation Capacity	39
Figure 26: The Effect of Probation Officer Caseload on Probation Officer Service Length	39
Figure 27: Response to a shock input	42
Figure 28: Relationship between stock reactions and capacity utilization	43
Figure 29: Cutting Loop B1	43
Figure 30: Behavior after reducing the gap adjustment time.....	44
Figure 31: Sentence lengths with (1) and without (2) loop B2.....	45
Figure 32: System behavior with (1) and without (2) Loop B2.....	45
Figure 33: Recidivism with (1) and without (2) loop B3	46
Figure 34: Capacity Utilization with (1) and without (2) loop B3	47
Figure 35: Fractional recidivism with (1) and without (2) Loop R2	48
Figure 36: Capacity utilization with (1) and without (2) loop R4	49
Figure 37: Population comparison with (1) and without (2) loop R4.....	49
Figure 38: Prison fractional recidivism comparison with (1) and without (2) loop R4.....	50
Figure 39: Probation population with (1) and without (2) loop B6	50
Figure 40: Comparison of prison capacity utilization with (1) and without (2) loop R7	51
Figure 41: Probation Fractional Recidivism with (1) and without (2) loop R7	52
Figure 42: Sensitivity to changes in construction time.....	53
Figure 43: Sensitivity analysis on Gap Adjustment time	54
Figure 44: Sensitivity analysis to changes in rehabilitation (0%, 33.3%, 66.7%, 100%) ...	54
Figure 45: Sensitivity to different flat rates in capacity utilization effect on rehabilitation	55
Figure 46: Capacity Utilization sensitivity to changes in probation workforce adjustment time	56

Figure 47: Capacity Utilization reaction to changes in perception of recidivism adjustment time	57
Figure 48: Different policy curves for the effect of political punitiveness on sentencing... 58	58
Figure 49: Different policy curves for the effect of recidivist fraction on the judiciary 59	59
Figure 50: Different policy curves for prisoner perception of the benefits of crime..... 60	60
Figure 51: Historic (1) and modeled (2) UK capacity utilization..... 61	61
Figure 52: Historic (1) and modeled (2) population development	62
Figure 53: Historic (1) and modeled (2) capacity development	63
Figure 54: Reference mode reproduction	63
Figure 55: Capacity utilization sensitivity to changes in the time to perceive changes to the crime rate	64
Figure 56: Capacity Utilization sensitivity to time to change public punitiveness. 65	65
Figure 57: Quick build policy structure	67
Figure 58: Effect of capacity utilization on construction	68
Figure 59: Policy structure: Custody Extra..... 69	69
Figure 60: Equilibrium shock test before (1) and after the quick build policy (2)..... 70	70
Figure 61: Prisoner population development without (1) and with quick build policy (2) . 70	70
Figure 62: Equilibrium Shock Test: Rehabilitation Effectiveness	71
Figure 63: Equilibrium Shock Test: Custody Extra..... 72	72
Figure 64: Future prison population scenarios. 73	73
Figure 65: Quick Build policy under 3 different scenarios	74
Figure 66: Improved rehabilitation policy under three different scenarios	75
Figure 67: Custody Extra under three different scenarios	76
Figure 68: Equilibrium test: Before (1) and after cell gap adjustment policy	94
Figure 69: State of emergency under 3 different scenarios. 95	95

Abstract

The prison population of the United Kingdom is the largest in Western Europe. It has been operating beyond its designed capacity for over 20 years. This paper addresses the root causes of this overcrowding and why despite a 42% reduction in crime, the overcrowding problem continues to worsen. A simulation model has been built to explain system structures behind the overcrowding behaviour pattern, and to understand the long term effects of policies which in the short term appear to slow the increase in overcrowding. This model explores how feedbacks from overcrowding can affect both judicial and policymaker behaviour. Through the application of the system dynamics method this model provides policy makers with a tool to understand the dynamic problem of overcrowding, to improve planning of when and how to implement future policies, and improve forecasts of future prison population trends.

Key words: prison, system dynamics, overcrowding, management, policy design, England and Wales, prison population, model, penal, prison, criminal justice.

Acknowledgements

I have been very lucky to have ever patient advice of my supervisor David Wheat. His constant clear guidance has been invaluable not only in the writing of this paper but also in developing much deeper insights into the real world applications of System Dynamics. My meetings and conversations with him have always been fruitful and have helped me to organize my ideas in clear understandable terms. In specific areas of my model his help and encouragement has taken my work into new directions which would otherwise not have been possible.

I would also like to thank Professors Pål Davidsen and Erling Moxnes for their instruction in my first year of System Dynamics. Thanks also go to the other students of my system dynamics class. Special thanks is made to Sebastian, Frode, and Dennis without who's help this thesis would not have been possible.

Thanks also go to the Douglas McKelvie at Symmetric, and the team at the Ministry of Justice for taking the time to help in forming the initial ideas used in this model.

Finally thanks to Heidi for patiently putting up with me through the process of writing.

Introduction

“...the prisons crisis had been both predictable and predicted...”

(Morgan 2008)

Over the last 15 years the number of prisoners in England¹ has almost doubled, rising more quickly than any other European country (Ministry of Justice, 2008). The capacity of the prison system to house prisoners has been increasing every year, but at a slower rate than the growth of the prison population. The discrepancy between prison capacity and prison population has resulted in increasing numbers of prisoners crowded into shared prison cells. Overcrowded prison conditions have been linked to increasing levels of prisoner suicide, disobedience, and recidivism (European Committee for the Prevention of Torture 2005, Ministry of Justice, 2008). Whether through control of prison capacity or control of prisoner numbers, the prison needs long term solutions to its capacity problems.

Previous studies of the prison system have attempted to model links between the police, courts and the prison system. In England the National Offender Management Service (NOMS) controls the management of prison and probation services. The model in this paper is intended to aid in NOMS long term strategy for controlling overcrowding. The basic model traces the critical path from sentencing to release, and incorporates feedbacks of recidivists re-entering the prison system. The basic structure is intended to increase understanding of the effects of building delays, sentence length changes, and different rates of recidivism. The paper proceeds beyond previous models. In line with research in the field of criminology and psychology the model endogenizes sentence lengths, and recidivism rates through modeling the structure of perceptions of the systems performance and the influence of that perception on prison overcrowding. There is a growing body of work by researchers such as Julian Roberts linking the difficulties encountered in reducing overcrowding to a lack of understanding of the different perceptions and goals of the judiciary, public, and politicians. This paper takes these perception problems and builds them into a model of the punishment system. System dynamics models have overlooked the role of misperception in penal policy, choosing to focus on the interrelationships between different agencies in the Criminal Justice Process. It was felt that modeling the mental models of the groups within society that affect the behavior and structure of the

¹ This paper refers to the jurisdiction of England and Wales as England. The other parts of the United Kingdom: Scotland and Northern Ireland have independent parliamentary control of their justice systems.

criminal justice system could prove to be a key tool in the creation and implementation of new policy.

Seven main sections and an appendix follow this first introductory section. The second section reviews the current penological and system dynamics literature. The third section provides a definition of the dynamic problematic behavior of prison overcrowding between 1988 and 2008. The fourth section describes the hypothesis for overcrowding implicit in the model structure, paying particular attention to feedbacks and delays. The fifth section analyses the model, and describes how the validity of the model has been tested. The sixth section is an analysis of the effects of different policy modifications designed to reduce overcrowding. The final section concludes the paper with recommendations and implementation issues.

Literature review

“impossible policies start with far fetched resolutions.”

(Neil Kinnock, Guardian Oct 1985)

The predominant purpose of this chapter is to survey the literature on prison population growth, as this is the primary driver for prison capacity expansion (Cavadino 2008, Bourne 2005). The chapter begins by exploring the relationship between the growth of public punitive demands and the growth of the prison population. A discussion is then made of the effect of public punitiveness on judicial decision making, and the problems of judicial policy resistance. This leads onto a discussion of misperceptions of the workings of deterrence and an overview of the variables which are currently believed to reduce re-entry into the prison system. The chapter continues with an overview of system dynamics models relevant to the prison system. The chapter concludes with a summary of the intended contribution of this study to system dynamics criminological research.

Statements in the media and political reports

The mandate of Her Majesty's Prison Service is to serve the public by keeping in custody those all those committed by the courts (HM Prison service). The investigation into the causes of overcrowding must therefore examine what the public wants, and why. Examination of headlines from the national press is illustrative of the current public demand for punishment: “Shocking figures show judges are jailing fewer criminals” (*Daily Mail*, 28 February 2007), “Soft judges, derisory jail sentences and the subversion of justice” (*Mail on Sunday*, 12 May 2005), “Judges on Trial: we demand end to soft sentences” (*Sun*, 12 June 2006)². Such headlines imply that the public perceives sentencing to be too lenient. Rhetoric and press statements from both government and opposition have appeared to come into line with the public mood since the mid early 1990's. “Society needs to condemn a little more and understand a little less” (John Major 1993, *Mail on Sunday*), “If the criminals think they can get away with it they will. And at present far too many do”

² Extracted from Hough and Jacobsen (2008)

(Tony Blair 1993, Sun)³. The public perception and political rhetoric appears to have impacted the decision making of judges⁴ in individual cases.

The 2007 government commissioned Carter report looked into the problem of prison overcrowding, and concluded that the growth in prison population was reflective of the public interest. The result of changes to legislation and sentencing pattern were found to have increased the use of prison as a punishment by a quarter and reduced the use of fines by the same amount. Sentence lengths were found to have increased, whilst numbers of people arrested and sentenced were found to be broadly constant since 1996. The 2007 report has been widely criticized for relying on limited evidence for public support for prison population growth to justify deep changes to the sentencing powers of the judiciary and a large scale prison building program (Justice Committee 2008, Newburn 2007, Hough et al 2008, Green 2007, Lacey 2008). In an independent report by the prison reform trust, designed to look at changes to sentencing recommended by Carter begins with a clear undiluted warning:

“Simply constraining sentencers’ discretion, without addressing the underlying pressures for tougher sentencing, is a not a viable, long-term solution to the prisons crisis.”(Hough et al 2008)

Hough summarized academic commentary on the emergence of increasingly populist, punitive, law and order focused policies apparent in the electoral rhetoric of 1992. Despite serious concerns over overcrowding problems in the mid 1990’s the majority of legislation developed since the 1992 election seem designed to increase the prison population: the 1993 Criminal Justice and Public Order Bill reduced the use of cautions and the right to silence, the Crime Sentences Act 1997 introduced automatic life sentence for second violent offences and mandatory minimum sentences for drugs and burglary. Mandatory sentencing has continued to grow with each successive Criminal Justice Act⁵ (Hough et al 2008). Lacey (2008) has described the developments in political punitiveness as a case of

³ This was also the year of the murder of two year old Jamie Bulger. For further examples of political reaction to this murder, and the wider implications for public perception see Green (2007). Tim Newburn (2007) provides a comprehensive history of the development of political rhetoric since 1992.

⁴ One recent example being a statement during sentencing in the Court of Appeal: “offences of this kind have escalated and in the public interest this crime must be confronted and stopped” (R v Povey, McGeary, Pownall and Bleazard [2008] EWCA Crim 1262)

⁵ As has judicial policy resistance: (16 Mar 2009 *Daily Telegraph*).

politicians being trapped in their own “prisoners dilemma”⁶, as securing popularity overrides ideological and policy concerns.

Academic Analysis

Tim Newburn (2007) has suggested that a part of the explanation for the growth in punitiveness could be a time lagged response to rising crime. Newburn (2007) reached his conclusion by assuming that historic incarceration rates are reflective of public punitiveness. He then compared incarceration rates to recorded crime figures over the last 25 years. He found that the rise in reported crime before the 1990’s did not correspond with a rise in incarceration. The rise in incarceration rates was found to be steepest when reported crime was *falling* after 1995. Newburn (2007) also theorized that a time lag exists between actual crime rates and public perceptions of crime. His evidence for this came from analysis of responses to the British Crime Survey in 2005. Three fifths of the respondents to the survey erroneously believed that crime was increasing. The public respondents to the British Crime Survey have been wrong on the direction of the crime rate since the data was first collected in 1996. Respondents to the British Crime Survey have also demonstrated a lack of knowledge as to the true sentence lengths for crimes, even when a mandatory minimum sentence has been applied in response to public pressure (Roberts 2003).

Tony Bottoms (1983) has been critical of the effect of growing punitiveness on the English system of punishments. Traditionally “serious offenders” have received long prison sentences, whilst fines and non-custodial penalties have been reserved for “less serious offenders”. Bottoms (1983) stated that the dividing line between “serious” and “less serious” offenders is unclear, and any harshening of penalties for the “serious offender” would eventually lead to harsher penalties for the “less serious offender”. The Mair and Mills (2009) report into non-custodial penalties found some evidence for Bottoms’ argument. Sentencers have been given more non-custodial penalty options in recent years in an attempt to divert people away from the prison system. Mair et al (2009) presented evidence that sentencers have reacted to directives to increase the use of non_custodial penalties by becoming more punitive; ratcheting punishment up rather than scaling it down.

⁶ There are several variants of the prisoner’s dilemma in game theory. Typically, two participants are required to play the roles of suspects under interrogation for armed bank robbery. They face the choice of betraying the other or staying silent. If both stay silent, they face a six month sentence for possession of firearms. If each betrays the other, they both face five years in prison. If only one betrays the other, he goes free and his co-conspirator gets ten years. The dilemma illustrates problems of trust in competitive situations: mutual distrust results in mutual betrayal, and thus in sub-optimal outcomes for both participants. (Hough et al 2008)

Non-custodial penalties were found to be applied when previously only a fine would have been given (Mair et al 2009).

Mair et al (2009) also found an increase in the imprisonment rate for those breaching the terms of non-custodial penalties. It has been suggested that the increasingly punitive law and order driven political environment has increased the risk aversion of parole and probation services (Collins 2007). Non-criminal breaches of parole and probation license conditions have been an increasing reason for sending offenders to prison (Mair et al 2009, Padfield 2006). Mair et al (2009) also observed that offenders with previous non-custodial penalties were also found to have a higher probability of imprisonment if convicted of a later offence.

It has been asserted that pressure for harsher penalties and longer sentences lies in the model of general deterrence that forms the backbone of the justice system (Cavadino et al 2008, Kleiman 2009, Becker and Landes 1974). Wheat (1972) provided an economic model of general deterrence within the Boston heroin market. Wheat's (1972) work hypothesized that offenders are rational actors who make a mental cost benefit analysis before embarking on a crime. Increasing the potential cost for a crime will decrease the commission of a crime. The most prominent application of rational economics to criminal justice was conducted by Becker (1974). Both Becker (1974) and Wheat (1972) calculate the potential cost of a crime with the following equation:

$$\text{Cost of sanction} = \text{probability of sanction} * \text{length of sentence.}$$

Hernandez and Dyner's (2001) system dynamics model of overcrowding in Colombia relied on this equation and reached the conclusion that an increase in sentence lengths will in the long term reduce the prison population. Though a similar conclusion has been used to justify the increase in English political punitiveness the importance of sentence length on deterrence has been questioned for some time. The results of Robert's (2003) examination of the British Crime Survey responses indicated that even highly publicized changes to sentence lengths did not have a strong long term affect on public perception. If the visibility of sentence lengths is low this implies that the deterrent effect of sentence length is also low (von Hirsch et al 1999). Kleiman (2009) has also theorized that the further away each consecutive portion of the sentence was from the commission of the offence the more its effectiveness diminishes.

Researchers have observed a similar affect on the detrimental impacts of punishment (Orsagh and Chen 1988). Orsagh et al's (1988) study of prisoners convicted of robbery in the US indicated that as sentences became longer, expected legitimate earnings and employment opportunities decrease. Orsagh hypothesized that "because of the loss of contact with the job market, expected earnings and employment in illegitimate activity increase" (Orsagh, T. et al 1988). Similar effects have been described in English publications (Boune 2005). If Orsagh and Kleiman's arguments are true the weight of the probability of punishment should be much higher than that of the length of sentence. But as has been apparent from the nature of media reporting it is the length of sentence which has had the greater influence on public policy and debate.

From analyzing the prison statistics Hedderman (2008) concluded that prisoner reconviction rates have risen throughout the period of prison population growth. The rise in reconvictions may be due to increases of people on short sentences, who have lost employment, accommodation and contact with their support networks without the provision of rehabilitative work either in prison or afterwards (Hedderman 2008). Harper and Chitty (2005) summarize research conducted into "what works" to reduce recidivism. The highlighted areas included raising educational levels, reducing drug use and providing proper treatment for the mentally ill. Philips and Votey's (1981) analysis of macroeconomic data also found a link between employment and offending. It is however difficult to be sure reductions in reoffending are causally linked to rehabilitation programs. Harper et al (2005) did find a general reduction in reoffending among offenders taking part in rehabilitation schemes, but also found a rise in offending by people who started but did not complete rehabilitation schemes. Numbers of these non completers will rise in overcrowded prison systems where offenders are regularly moved in the interest of space requirements (Bourne 2005). Recidivism statistics show that violent offenders have lower reconviction rates than "less serious" burglary and drugs offender categories – potentially because they are more likely to complete rehabilitative programs (Hedderman 2008). A study into the recidivism of long term prisoners released on parole found them 12% less likely to commit a violent offence (Ellis et al. 1998). Ellis suggests that this is because of their parole supervision. Non custodial reconviction rates have consistently proved to be lower than prison reconviction rates.

Modeling and system dynamics

The existing models of the English prison system concentrate on of mental health treatment capacity, for specific groups of prisoners. Findings from two of these models found the delivery of treatment programs to be highly sensitive to unpredicted rises in prisoner population (Smith et al 2004). The findings of these papers indicate that overcrowding does have a detrimental effect on rehabilitation and therefore on recidivism. Neither model attempted to create a prison system wide analysis.

There are three existing system dynamics models which look at larger scale prison populations and capacity development. Hernandez et al's (2001) Colombian model, mentioned earlier, provided a basis for examining deterrence. A model of the Dutch criminal justice system has been created (Rouwette et al 2007). Rouwette's model is the most similar to the one in this paper. Rouwette incorporated the influence of judicial perception on average sentence lengths and the affects of capacity shortages. Rouwette dealt with the problem of overcrowding by extending an idea put forward by Wolstenholme (2004): an increase in caseload in one part of the criminal justice system creates overcrowding, which results in the early release of prisoners. The lowering in crime from the increase in arrests are only short term as prisoners released early due to capacity problems add to the crime problem (Wolstenholm 2004). The dynamics of these models provide the basis for our examination of overcrowding however, it was felt that it is possible to incorporate the effects of increased police and court caseloads by beginning the model at the sentencing stage.

The most comprehensive system dynamics style of model covering the English prison system is the stock and flow model created by Grove and MacLeod (1998). Grove and MacLeod separated prisoners into serious and petty offenders. Both offender groups are recruited as a constant fraction from the total population. Both offender groups have constant recidivism rates. The difference between the two groups is the level of these rates. This model forms the basis for the long term prison projections currently used in England. The model does not however try to endogenize sentence lengths, or deal with the problem of matching capacity and demand. To find work that looks directly at the capacity problem we have to look at system dynamics models in other subject areas.

Sterman (2000) provides an example from the development of road infrastructure. Tackling the problem of traffic jams is tackling a problem of capacity overutilization. The

traditional and intuitive solution to traffic jams is to build more roads. According to Braess Law the addition of capacity to a crowded network can be detrimental to its performance (Sterman 2000). Increasing the number of roads adds to the popularity of road use and increases traffic further. (Sterman 2000) Increasing capacity tackles the symptoms of a problem, but in fact worsens the long term situation. If the same solution is applied over and over again a vicious and destructive spiral will emerge.

Tabacaru's (2007) work in the field of Human Resources provides a route to examining how sentencing policy changes. Tabacaru suggested that insight into policy decisions could be made by making the intangible variables in a system, such as *attitudes* tangible. If her hypothesis is applied to the prison system Newburn's (2007) theorized relationship between punitiveness and crime levels becomes a strong basis for analysis of the growth in demand for prison capacity. If the way punitiveness is accumulated over time can be affected, it may prove an effective measure for tackling overcrowding without building more prisons.

Summary

In this chapter we have reviewed the existing literature on the two main sources of prison population growth: increased punitive demand and levels of recidivism within the system. After reviewing the literature it was clear that three factors have remained unaddressed by system dynamics models of the criminal justice system:

- How the demand for punitiveness can potentially be understood by examining the public perception of crime levels.
- The extent to which recidivism can be affected by changes in post release observation and by diversion from prison.
- Whether increasing capacity is a viable method for tackling prison overcrowding or if it will just increase the prison population.

This study combines these factors into a single system dynamics model in the hope that it can aid in the construction of policies to reduce prison overcrowding.

The Dynamic Problem

Overcrowding is defined as the ratio of population and capacity. Figure 1 displays the growth of overcrowding alongside the trends in Prison Population and Prison Capacity development.

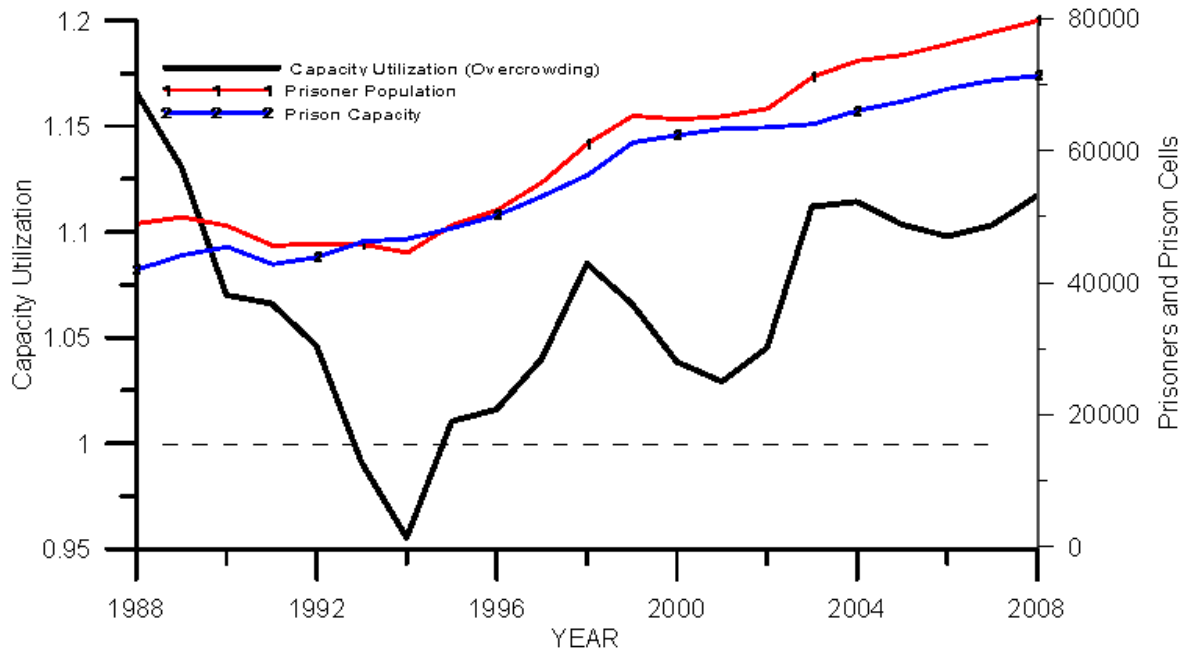

Figure 1: Prison Population, Capacity and Overcrowding from 1988 to 2008.
(Offender Management Statistics 2008, Prison Statistics 1995)

Between 1988 and 1993 there was a significant reduction in overcrowding as the prison population fell and prison capacity began to increase. Prison population and capacity have been increasing since 1993. Overcrowding has been on a growth trend since 1993 but there have been two drops in overcrowding. The largest reduction occurred between 1997 and 2000. Prison population growth had begun to level off during this period, whilst prison capacity continued to grow. A second reduction was visible from 2003 to 2006. The sharpest increases in overcrowding occurred from 1995 to 1997, and from 2001 to 2002.

Existing Policy Approaches

Policy over the last 20 years has had a significant impact on the development of overcrowding. A general tendency has been to promote policies that increase the prison population before elections and after highly publicized violent offences. Such policies rarely take the capacity of the prison system into consideration. In the diagram below election years and murders are placed to the right of the prison system’s capacity utilization status. Policies are on the right hand side.

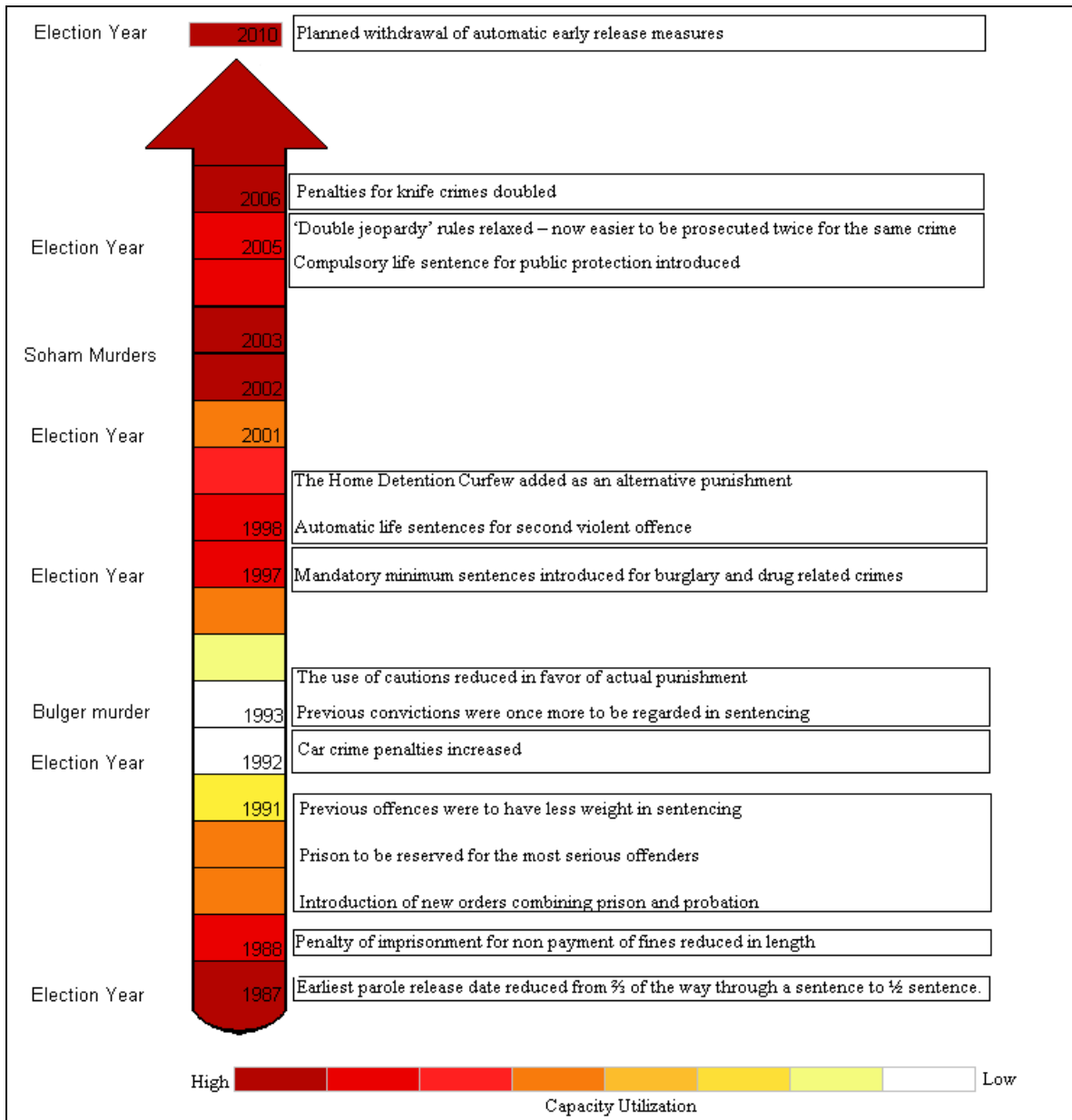

Figure 2: Significant legislation and events affecting population development

It is our view that behind the seemingly “knee jerk” reactions to events there is a dynamic system in operation. Understanding the structure of the system is essential to control its behavior.

Hypothesis

The system dynamics model described in this section offers one possible explanation for why matching capacity and population has proved so hard to accomplish in the recent past. In order to avoid confusing phrases, such as negative overcrowding, we will from here on use the phrase prison capacity utilization⁷. The description of this model begins with a general overview of our hypothesis. A discussion centered on causal loop diagrams follows and highlights the main feedbacks within the model we believe are responsible for the system's behavior. Then the model boundary and the reasoning behind our main assumptions are set out. Finally the stock and flow structure of the model is explained, paying particular attention to the delays and interactions between the model sectors.

Hypothesis overview

The harshening punitive stance taken by English society in response to crime has been an important contributing factor in the development of the capacity utilization problem. There is a continual push in England for more offenders to be imprisoned for longer periods of time (Roberts 2003). The demands of a punitive society require significant, continued investment in the maintenance of the existing infrastructure and construction of new prisons. Planning and construction work takes time. During the inevitable delay between increased demand and construction completion, capacity shortages will occur. Once capacity utilization problems arise the rehabilitation of offenders becomes a secondary priority to harsh punishment and the secure housing of offenders. Without rehabilitation work, the problem of recidivism will worsen. Worsening recidivism feeds back into society's general attitude to punishment, causing further demands to be tougher on crime and criminals. Such demands work to increase capacity needs in ways that are difficult to forecast.

⁷ Prison capacity utilization is the percentage of capacity being used by the population. A prison with over 100% capacity utilization is overcrowded.

Figure 3 summarizes our hypothesis and provides the general shape of our model. Two factors appear to be central to understanding punitiveness: the public's delayed reaction to the crime rate (Newburn 2007), and the judicial/politically perceived rate of recidivism (Mair 2007, HM Prison Service 2001). The crime rate is considered an exogenous factor in this model⁸. The central hypothesis of this paper is that controlling recidivism is central to controlling population growth and capacity development. Policy makers and sentencers use the number of previous offences committed by an offender to assess the seriousness of offences. Reducing recidivism will reduce the perceived seriousness of offences. Lowering recidivism will cut off one of the direct causes of population growth; the increasing probability of imprisonment and sentence length assigned to recidivists (Mair 2007, Bottoms 1983).

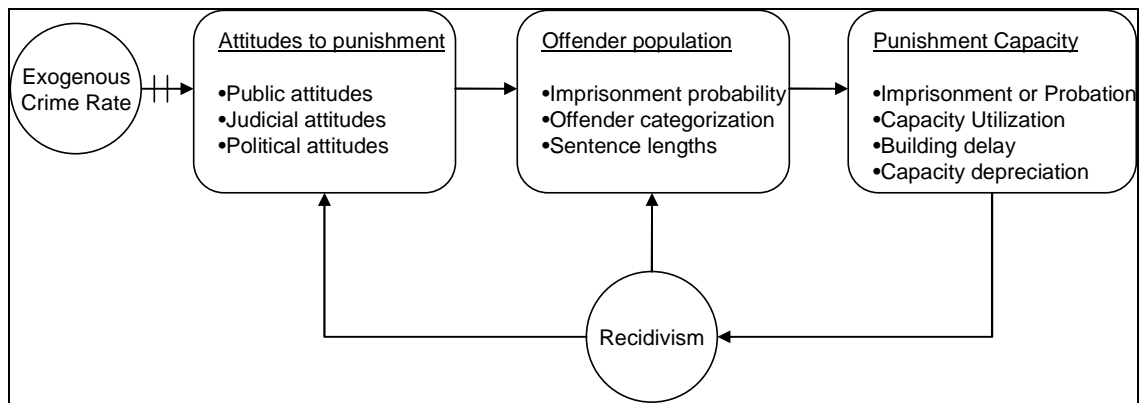

Figure 3: Subsystem diagram

The rate of recidivism can be affected by investment in rehabilitation efforts within the prison system (Harper 2005). The problem with attempting to control recidivism is that high capacity utilization makes rehabilitation work more difficult to carry out. This dilemma provides some support for providing rehabilitative training within non custodial, probation based penalties.

Causal loop diagram: Prison Capacity

The simplest model of Prison Capacity Utilization features no feedback (Figure 4). From the literature review we can conclude that Prison Capacity Utilization increases with Prisoner Population growth and decreases with increases to Prison Capacity. It is assumed that changing either variable will be sufficient to impact Prison Capacity Utilization.

⁸ In our discussion of the economic equation for general deterrence (Wheat 1972, Becker 1974) the role of sentence lengths was found to have a little influence on deterrence or the crime rate (Kleinman 2009).

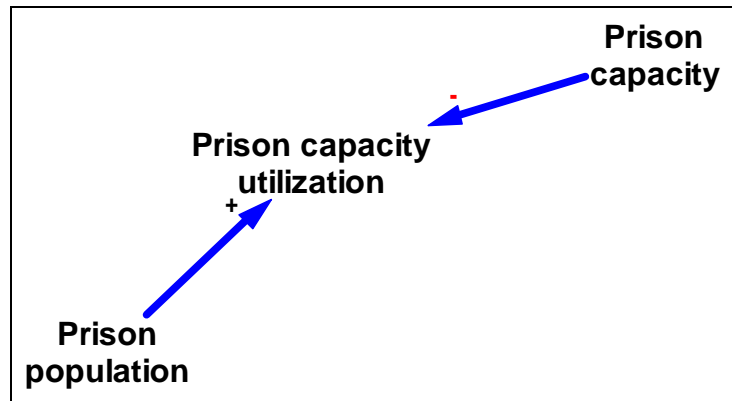

Figure 4: The main factors affecting prison capacity utilization.

Figure 5 introduces the first feedback in the system. When the prison population increases there is pressure to allocate funds to prison building. Current examples include the recent calls for giant Titan prisons, and the commissioning of prison ships (British Broadcasting Corporation, 2010). As new prison places are built, and the size of the prison estate begins to catch up with the prison population, the requests for new prison construction should die down. In a perfect world balancing feedback loop B1 should act to keep prison capacity equal to the prison population. In practice it has been rare to find population and capacity in equilibrium (Figure 1). The disequilibrium witnessed in Figure 1 is due to the building delay in loop B1, as it takes time to build new or replace old prison cells.

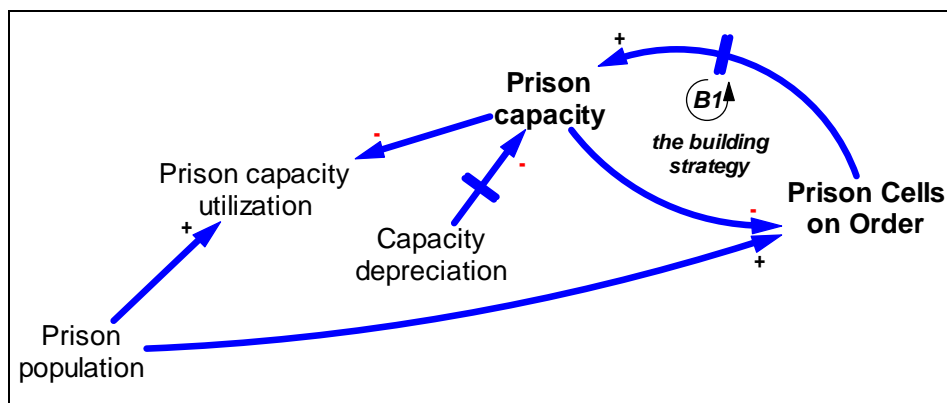

Figure 5: Prison capacity: feedback loop B1

Causal loop diagram: Prisoner population

Early release schemes and altered sentencing rules continue to be advocated as measures to cope with capacity shortages (Cavadino 2005, Council of Europe 2002, Carter 2007). In Figure 6 balancing feedback loop B2 traces the mental model behind sentence length adjustment strategies. In the short term lowering the average sentence length means offenders stay in prison for less time – decreasing the prison population. Once the pressures of capacity utilization problems are reduced, sentence lengths rise again.

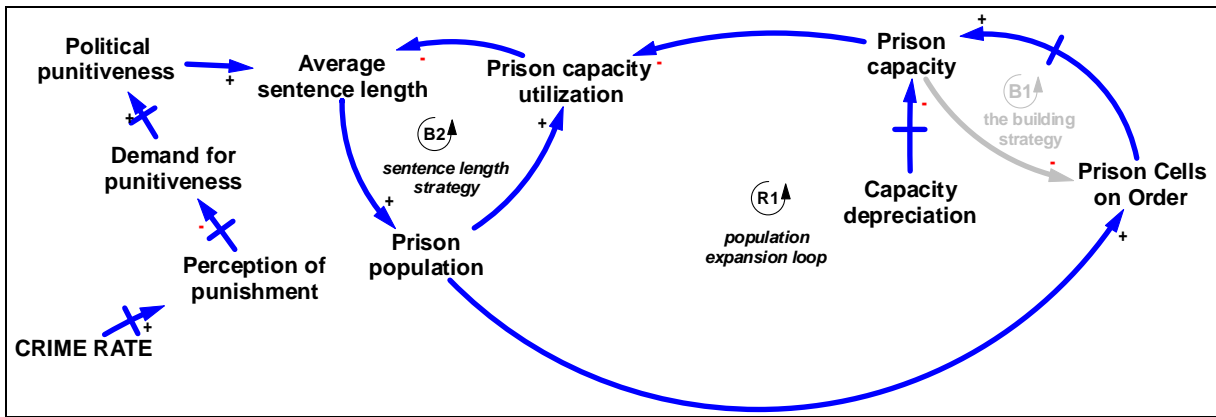

Figure 6: Sentence Length Feedbacks (balancing feedback loop R1 and B2)

There is a danger that increases in sentence lengths can spiral out of control. In reinforcing feedback loop R1, longer sentence lengths increase the pressure to obtain sufficient capacity for the growing prison population. The more spare capacity there is in the system, the less pressure there is to reduce sentence lengths.

The prevailing punitive trend in society is an external factor that acts to increase sentence lengths. According to Newburn (2007) the central drive for increased punitiveness is rooted in delayed social perceptions of the crime rate. The effect of the punitive trend is visible in the removal of automatic early release provisions in the run up to the 2010 general election as being “soft on crime” is a potential vote loser (British Broadcasting Corporation, 2010).

Within the prison system punitiveness can be affected by the number of recidivists in prison. The more recidivists enter the system the longer the average prison sentence will be (Figure 7). In the Punitive Drift Loop R2 increased capacity utilization problems arising from longer sentence lengths cause can reduce the delivery of rehabilitation programs and make recidivism worse. The tendency towards “punitive drift” can be held in check by building more prisons (feedback loop B4). Attempts to expand capacity in line with the population will still however be limited by the building delay.

The Rehabilitation Loop B3 (Figure 7) adds further complexity to the system. Offenders serving short sentences rarely stay in prison long enough to complete rehabilitative programs (Hedderman 2008). So reducing sentence lengths could increase the numbers of offenders who fail to receive help in addressing the causes of their offending behavior. Such prisoners (especially those with serious drug problems) have an increased chance of recidivism. Loop B3 comes full circle as increased recidivism can be a

Causal loop diagram: Imprisonment Probability and Probation Population

Diverting offenders from prison into punishments based upon probation is another strategy for reducing the use of prison capacity. Such strategies include the home detention curfew order, drug treatment orders, suspended sentences and community service work. Whilst the diversion strategy (Figure 9, balancing feedback loop B6) will reduce the prison population, it is not a “magic bullet”. A high caseload (probation capacity utilization) per probation officer will tend to reduce the rehabilitative effort that can be made towards each offender⁹. The loop B6 will ensure that probation population is tied to probation capacity. If probation caseloads become too high recidivism will rise and prison will become more popular as a punishment (loop R4). The additional strain of prisoners released on parole (R5 and R6) puts further pressure on probation – even though direct use of probation has dropped.

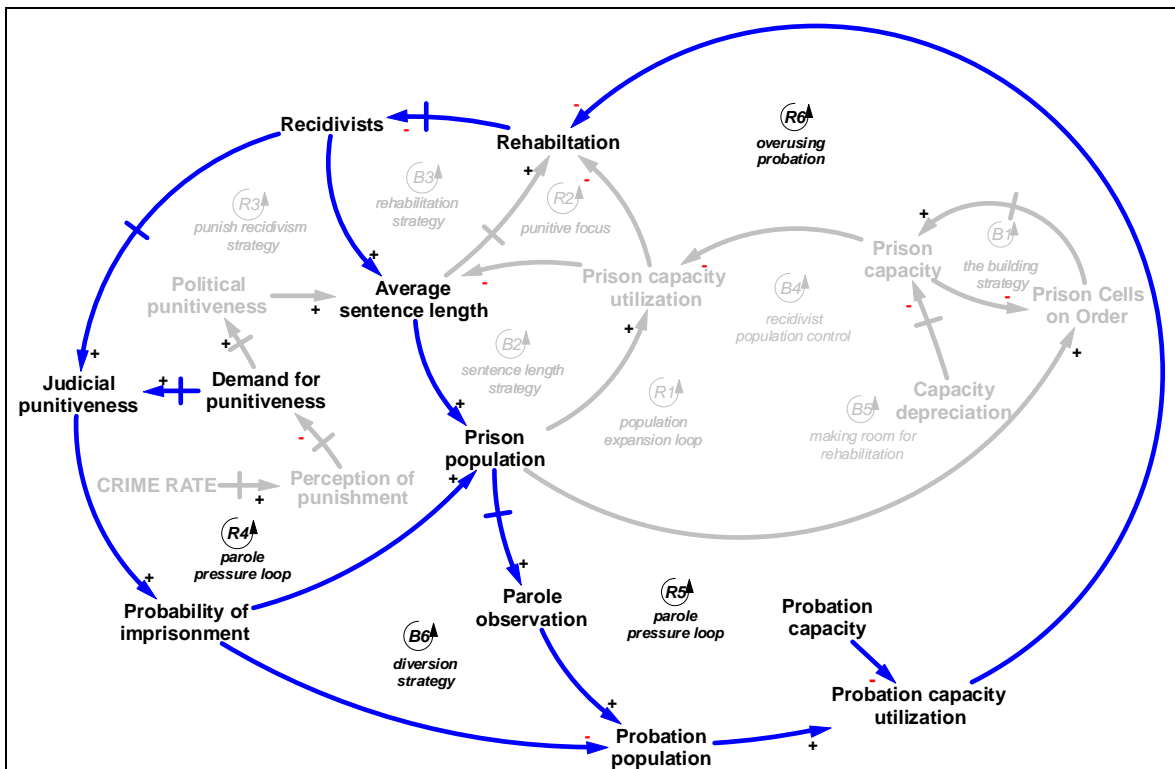

Figure 9: Diversion strategy: Causal loops B6, and R4, R5, R6

Causal loop diagram: Probation Capacity

⁹ Prisoners released on parole are also under the observation of probation services. So they have to be included in the numbers for the probationer capacity utilization.

Probation capacity is governed by the demand to keep the probation caseload low (Figure 10, reinforcing feedback loop R7). Hiring new probation staff to keep up with the demands of caseload takes time. If there is too high a probation caseload, staff will begin to leave the service (balancing feedback loop B7). Though it has not been explicitly modeled here the experience level of staff will also impact the efficiency of service delivery.

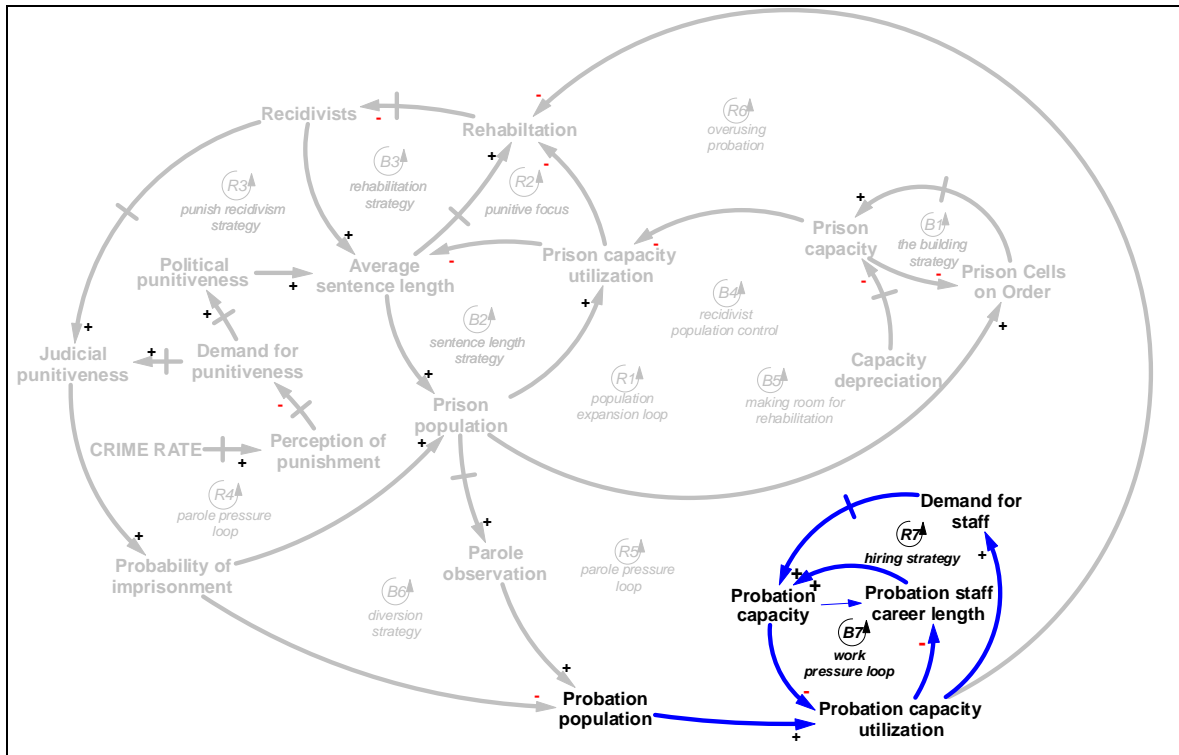

Figure 10: Probation Capacity Loops R7 and B7

Model Structure

The next section presents the main components and assumptions of our model. This section is designed to explain the logic behind the choice of specific variables and specific structures. Only a selection of equations and model detail will be presented here. A list of equations is available in Appendix 1 and a file with the full model in iThink accompanies this paper.

The model will be presented as follows in separate sections:

- Model boundary
- Time horizon
- The Stock and Flow Structures
 - The framework of attitudes to punishment
 - The offender population framework
 - Serious and non serious offenders
 - Parole
 - Probation
 - The prison capacity framework
 - Quick build strategy
 - The probation capacity framework
 - Work pressure
 - Recidivism framework

The Model Boundary

The variables included in this model are those considered vital for understanding attitudes towards the punishment system, and the interplay between capacity utilization problems and the performance of the prison system.

<i>Endogenous</i>	<i>Exogenous</i>	Excluded
<ul style="list-style-type: none"> • Rehabilitation • Recidivism • Sentence lengths • Attitudes to punishment • Parole • Service Length 	<ul style="list-style-type: none"> • Crime Rate • First Time offenders • Training and Hiring Time • Desired Officer to Offender Ratio • Effect of budgetary and economic changes • Election cycles • Probation length 	<ul style="list-style-type: none"> • Deterrence • Policing changes • Probation officer experience • Fines and other diversionary punishments • Guilt/Innocence • Different recidivism rates according to time of release

Predicting the effect of prison and probation on the generation of new crimes was felt to be beyond the scope of this model. Research into the factors behind deterrence and crime generation have found a greater dependence upon policing and crime prevention measures such as the widespread use of car alarms (Kleiman 2009).

We have not included the budget for penal spending as it was felt that modeling the budget would warrant a separate modeling effort. It was felt that the effects of budget changes could be replicated through the use of the adjustment times in the capacity sectors.

The level of detail applied to each the sectors affecting overcrowding are reflective of the influence available to the National Offender Management Service. It is for this reason that the court system and the actions of the police have been summarized in a single delay in the Court sector. The decisions over the guilt and innocence of offenders was also felt to be beyond the scope of the prison system so all offenders in the model are assumed to be guilty.

Time Horizon

The accepted government analysis period for overcrowding is 10 years (Carter 2007). Hedderman's (2008) analysis of overcrowding included detail for the last 20 years. Her reasoning was the need to include the period before the prison population started to rise. We chose to follow Hedderman's reasoning and use a 20 year time horizon from 1988 to 2008. The periods between 1988 and 2008 is also near the limit of where reliable, coherent data can readily be accessed in electronic form.

The Stock and Flow Structures

The stock and flow structure will be described by subdividing the structure into modules similar to the structure seen in Figure 3. Each of the modules will be described separately starting with attitudes to punishment, followed by the offender population, capacity and lastly recidivism will be described. In the population and capacity structures we will first describe a simplified structure, and then the full stock and flow diagram.

The framework of attitudes to punishment

The framework of attitudes to punishment has two distinct parts: public attitudes and judicial attitudes. Public attitudes shape politicians views, and politicians shape sentence lengths. Judicial attitudes shape the seriousness attributed to offences and the probability of imprisonment. The two parts are further subdivided and described in detail below.

Public punitiveness is assumed to be shaped by a delayed perception of the crime rate (Newburn 2007) (Figure 11). As offenders are also members of the public we have assumed that offender perceptions of the benefits of crime are linked to the public perception of the crime rate. The higher the crime rate is the more beneficial crime is perceived to be (Roberts 2003). We have used slightly different curves to describe the prisoner and probated offender's perceptions of crime to represent the differences in how crime is perceived inside and outside of prison.

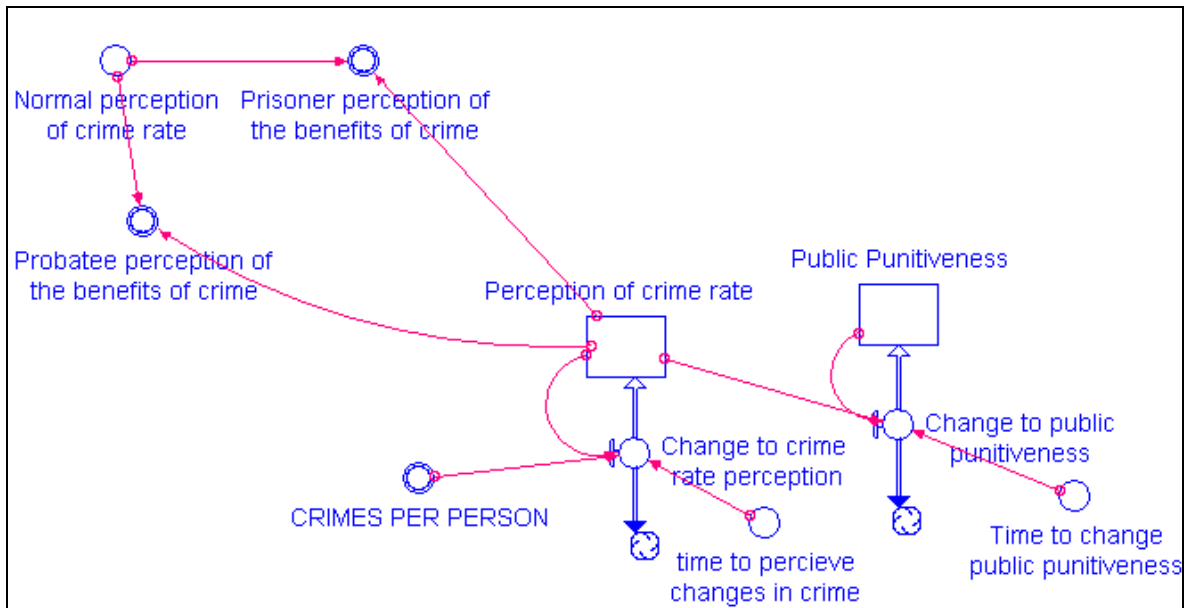

Figure 11: The public perception of crime

The public perception of the crime rate also determines the punitiveness of the political climate (Figure 12). Political punitiveness is represented as a delayed function of public punitiveness. We have assumed that political punitiveness creates changes to statutory sentence lengths. A second influence on sentence lengths comes from the political reaction to capacity utilization. When prisons are overfull politicians are more inclined to order mass early release of prisoners; effectively lowering their sentence lengths.

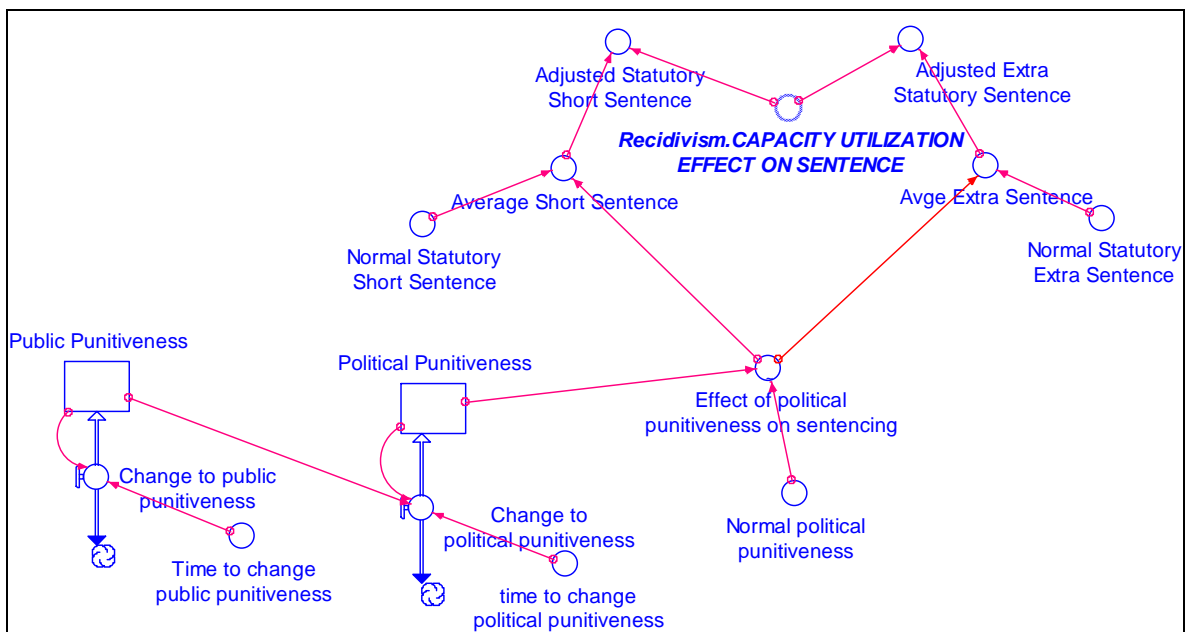

Figure 12: Public and Political Attitudes to Punishment

The judicial attitude is shaped by the judiciary's perception of the number of recidivists passing through their courts (Figure 13). The perceived number of recidivists influences sentence lengths (Stephenson, 1995) and the categorization of offences as serious or less serious (Bottoms & Brownsword 1983). The decision curves for seriousness and sentence length assume that the higher the recidivist fraction the more serious the offence and the longer the sentence. The effect on sentence length is multiplied by the adjusted statutory sentence to give the actual sentence length.

The third influence of the recidivist fraction is the punitive attitude of the judiciary. The punitive attitude of the judiciary decides the probability of being imprisoned for any given crime (Mair 2009). The imprisonment fraction is used in the next section to decide who goes to prison and who receives probation.

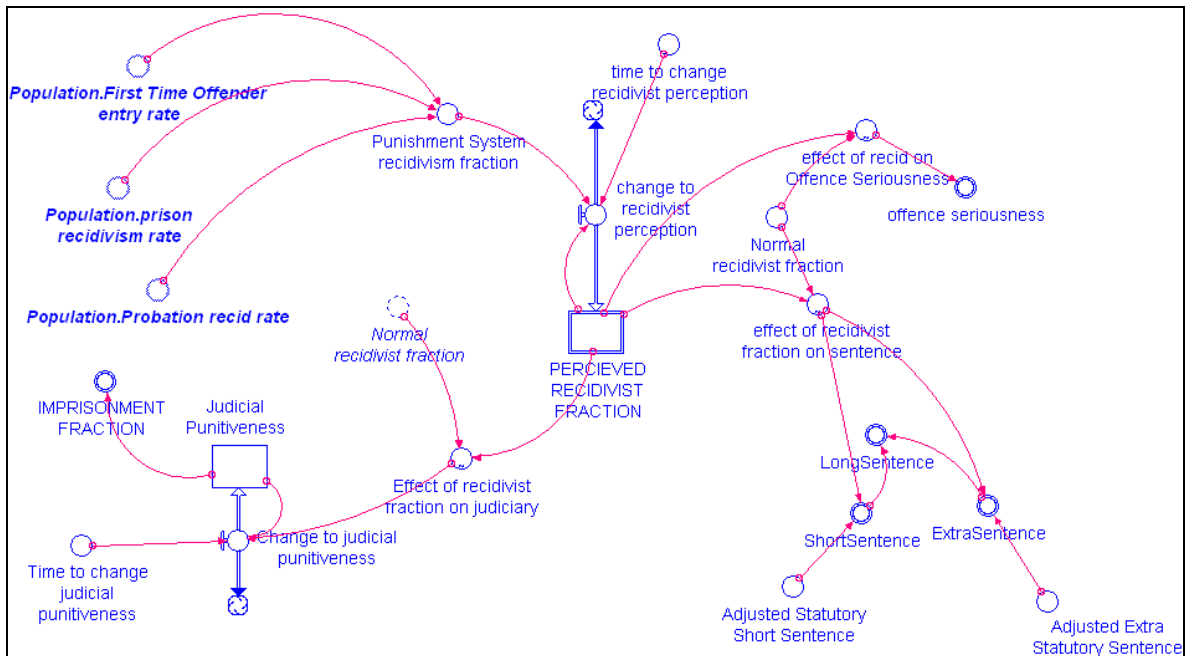

Figure 13: Judicial Attitudes¹⁰

The Offender Population Framework

The offender population structure is made up of three separate parts: pre-punishment, prison, and probation (Figure 14). The pre-punishment sector consists of one stock and an inflow. The awaiting trial and sentencing stock represents the court delay between capture and sentencing. The inflow to awaiting trial has been created using assumptions detailed in Appendix 3. All offenders enter the system through this stock.

¹⁰ In these diagrams stocks and variables with double line borders feed into other modules of the model. Any variables serving as input from other modules have the module name before the variable name, for example: Probation.First Time Offender entry rate.

Movement to prison or probation is decided by the imprisonment fraction shown in the attitudes module.

Offenders enter the prison sector via the prison entry rate and spend their sentence in the prison population stock (Figure 14). There are two ways of exiting the prison stock; being released unconditionally or entry into the serious offenders stock. Serious offenders serve longer sentences than other offenders. Once an offender has entered the released offender stock they have two paths. Reformed offenders enter the stock of reformed prisoners where they stay until they die. If an offender commits a further offence they re-enter the awaiting trial and sentence stock. Probated prisoners face a similar ‘choice’ at the end of their sentence.

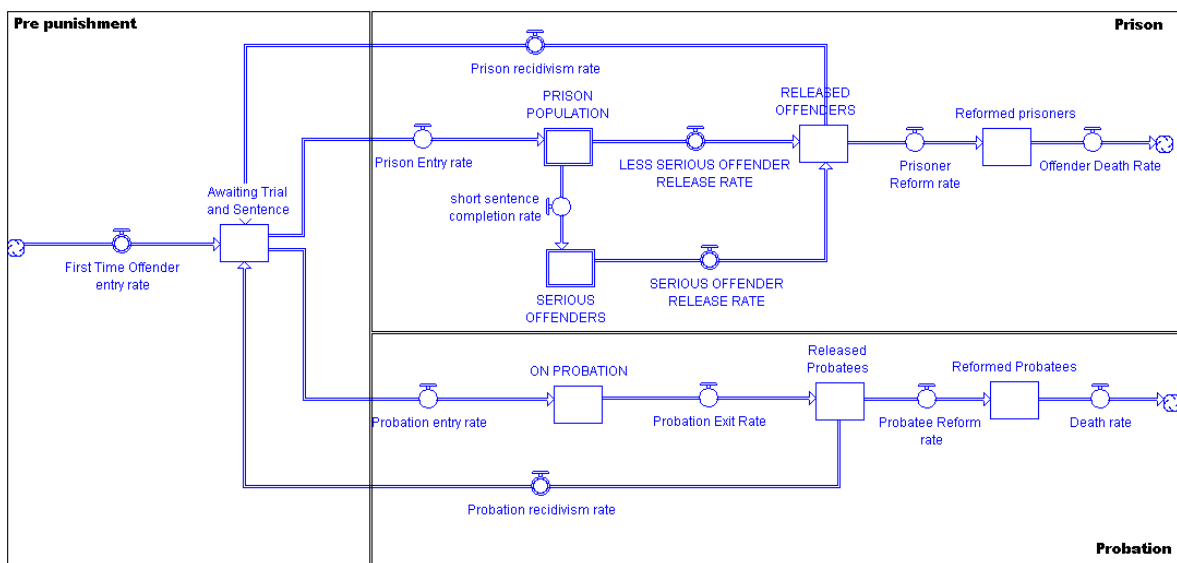

Figure 14: Offender Population: Stock and Flow structure

Serious and non serious offenders

The main feature of the prison population is the division between serious and less serious offenders (Figure 15). How many offenders enter the serious offender stock is dependent upon offence seriousness. Hedderman’s (2008) results indicate that violent crime has not risen, yet Carter (2007) claims that there has been a growth in the seriousness of offences. We reconcile these conflicting views to by assuming that the actual seriousness of offences has been stable, and recidivism has risen. It is because of the recidivism rise that crime has been viewed as more serious.

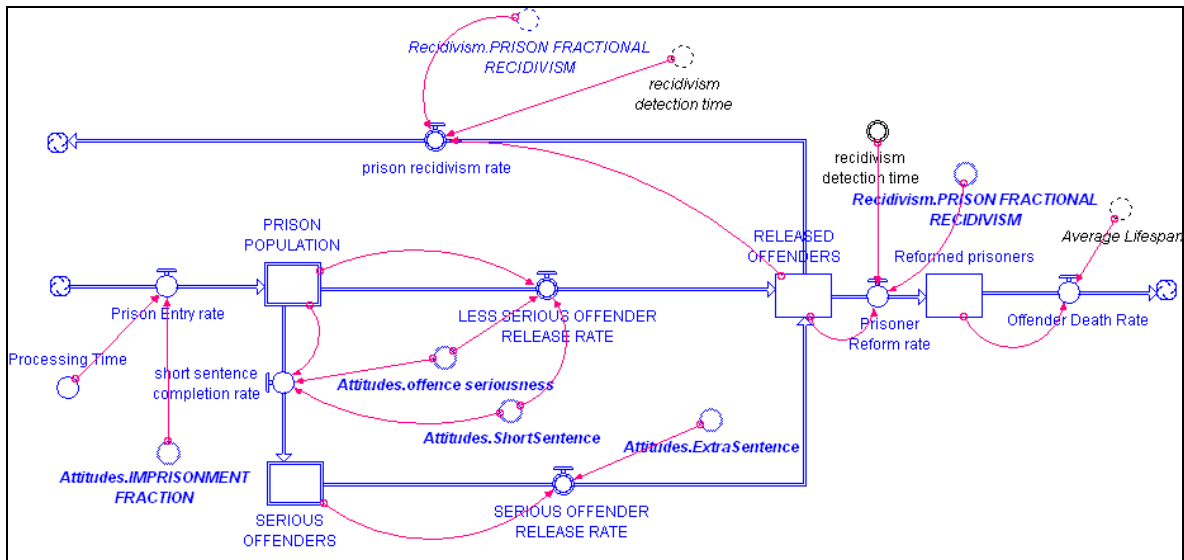

Figure 15: Prison population: Stock and Flow structure

Recidivism after release was assumed to be a function of the time it takes to detect recidivism, and the recidivism rate. The time to detect recidivism has been taken as being equal to the two year recidivism detection time used in the published prison statistics.

Parole

When serious offenders are released it is under the conditions of a parole license. Parolees have a lower recidivism rate than other offenders (Ellis, 1998), so the numbers of offenders on parole need to be tracked for use in the recidivism module. We track parole by using a co-flow. Paroled offenders parole license conditions last for a time proportionate to their original sentence. We have interpreted Ellis's work to mean that the time spent on parole can be spent providing rehabilitative/resettlement help.

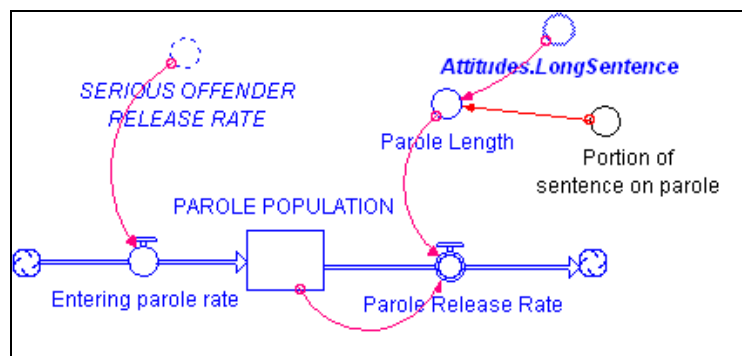

Figure 16: Parole population: Stock and Flow structure

Probation

The Probation Population structure is modeled simply, with a constant probation length of one year. Observation of probation length trends (Ministry of Justice, 2008) showed very little variance in the length of sentence, so we did not model this in detail.

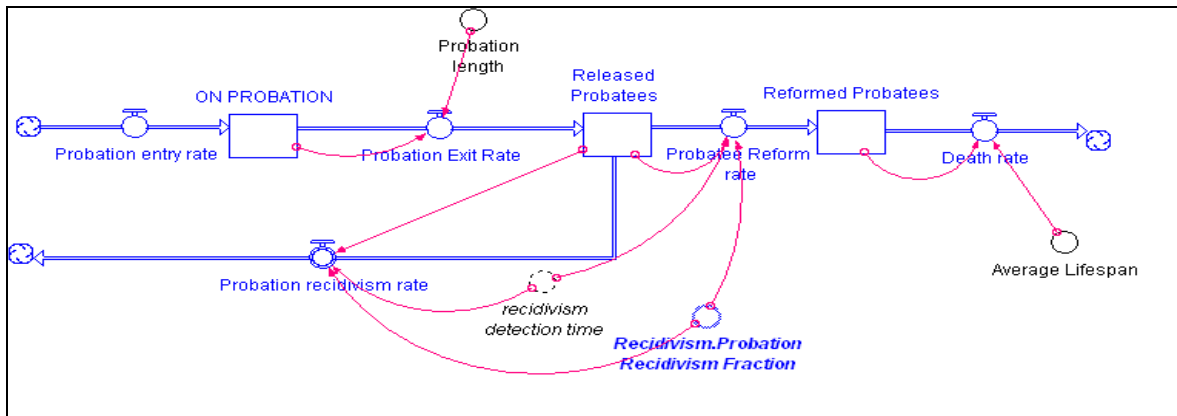

Figure 17: Probation population: Stock and Flow structure

Recidivism

The idea behind the structure shown in Figure 18 is that recidivism can be reduced through rehabilitation. The structure can be condensed into one equation:

$$\text{Offender rehabilitation completion} * \text{rehabilitation effectiveness} * \text{effect of capacity utilization} \\ = \text{Recidivism Reduction}$$

The reasoning governing the equation is that rehabilitation programs take time to implement. If the average sentence length is shorter than the time required to complete a rehabilitation program, then only a fraction of offenders (if any) will complete a rehabilitation program. Long term offenders have the additional benefit of time on parole during which rehabilitation can continue.

Next we assume that rehabilitation can produce a certain reduction in recidivism. We express this reduction as a fraction and multiply it by the fraction of offenders who complete rehabilitation programs. Once we have the potential recidivism reduction we need to know whether the capacity exists to deliver the full potential of the programs. To represent this we multiply the potential recidivism reduction by the effect of capacity utilization to give us the potential deliverable recidivism reduction.

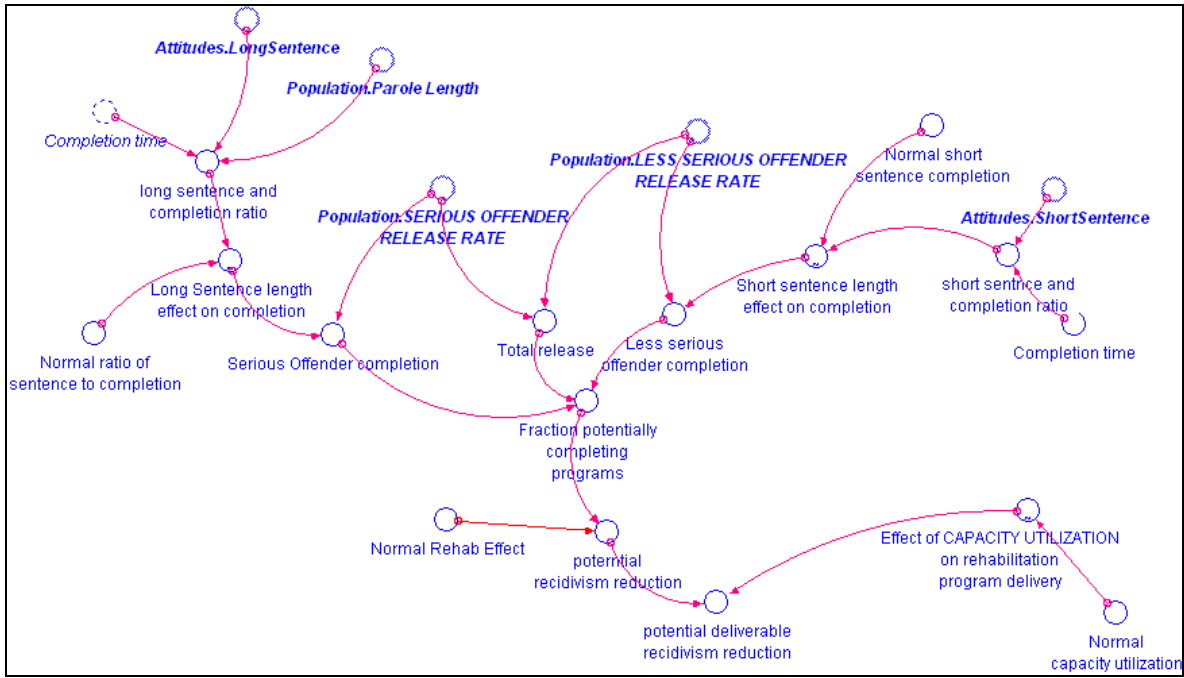

Figure 18: Rehabilitation

The potential deliverable recidivism reduction is used to define the actual change to recidivism (Figure 19). The actual change to recidivism has been modeled as a stock, to account for the fact that changes to rehabilitation programs also take time. The value of the actual change to recidivism stock is then subtracted from the prisoner perception of the benefits of crime to give the variable: Prison Fractional Recidivism.

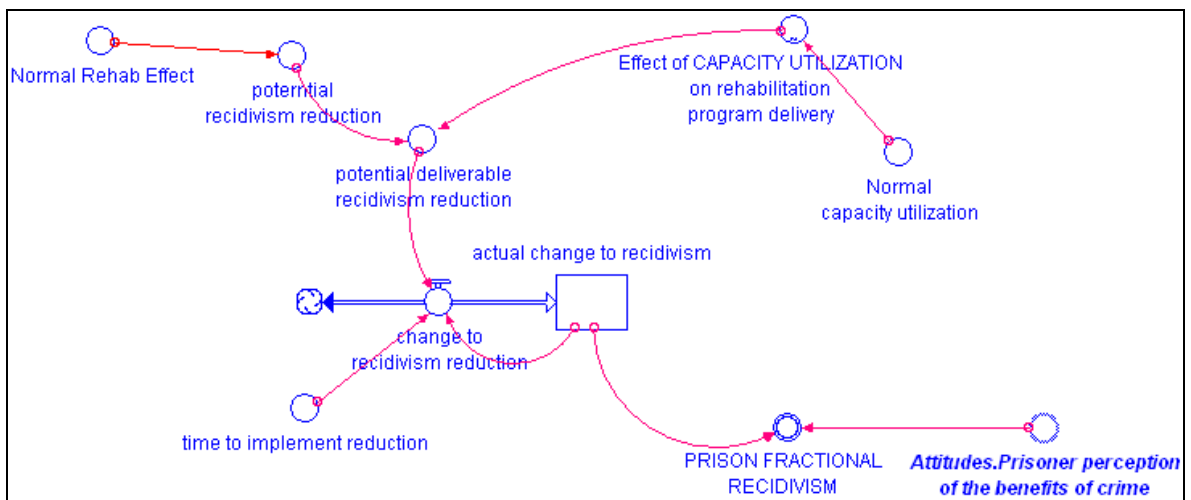

Figure 19: Recidivism reduction

We ran capacity utilization through a delay to ensure that prisoner’s rehabilitation was being affected by the level of capacity utilization experienced whilst in prison (Figure 20). The structure in Figure 20 is also used to calculate the capacity utilizations effect on sentence lengths (first seen in Figure 12).

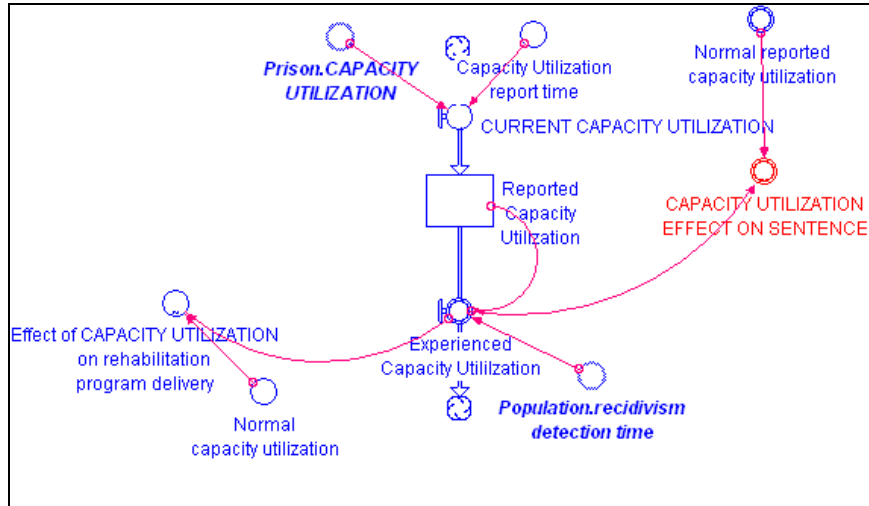

Figure 20: Experienced Capacity Utilization

Probation recidivism is calculated in a simpler fashion. Like prison recidivism, it is assumed that there is a baseline tendency to become a recidivist that is determined by the crime rate. The actual caseload experienced by the offender moderates the probation recidivism fraction through a non linear effect.

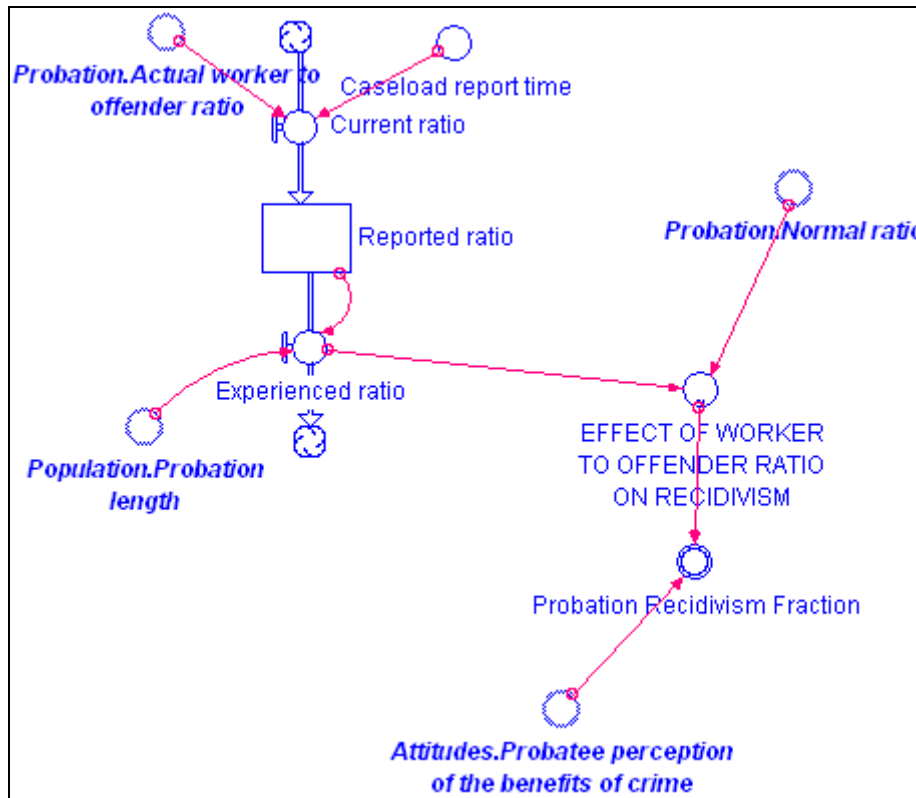

Figure 21: Probation recidivism

The effect of worker to offender ratio on recidivism (Figure 22) has been based on media reports. The ‘normal’ caseload of a probation worker in London is 40 offenders per worker (Marin, 2009). A caseload of 40 officers means a ratio of workers to offenders of 0.025. This value was used to normalize the function. The detrimental effects from caseloads over 100 have been modeled on a real life case from Lewisham in London (Marin, 2009)

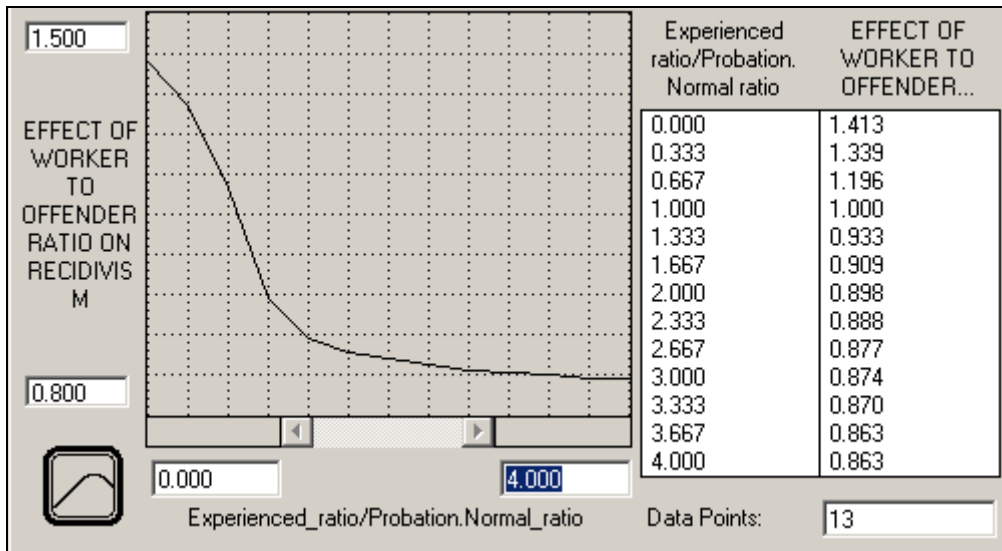

Figure 22: Effect of Worker to Offender Ratio on Recidivism

Prison Capacity Model

The prison and the probation capacity structures are very similar as they are rooted in John Sterman's (2000) inventory model. Figure 23 is the simplest stock and flow explanation of the prison system. Two stocks are used: Prisons Under Construction, and Prison Cells. Prison cells have to be ordered before construction can begin. It takes a prescribed amount of time for cells to be constructed. Once in service prison cells depreciate, according to their average lifetime.

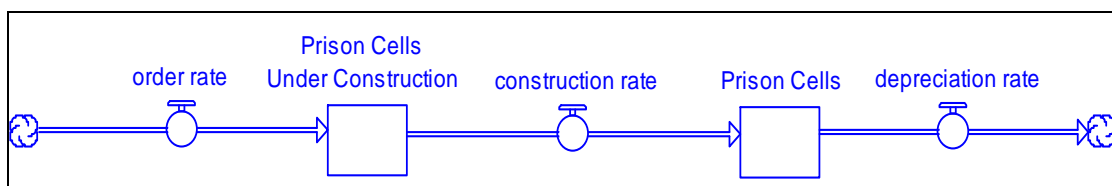

Figure 23: Simple Prison Capacity Structure

The full structure (Figure 24) details how the order rate is decided upon. The indicated order rate aims to replace cells lost through depreciation, and to close the gap between the forecast number of prison cells and the forecast number of prisoners. Within the formulation of the indicated order rate provision is also made to allow for the cells which are currently under construction.

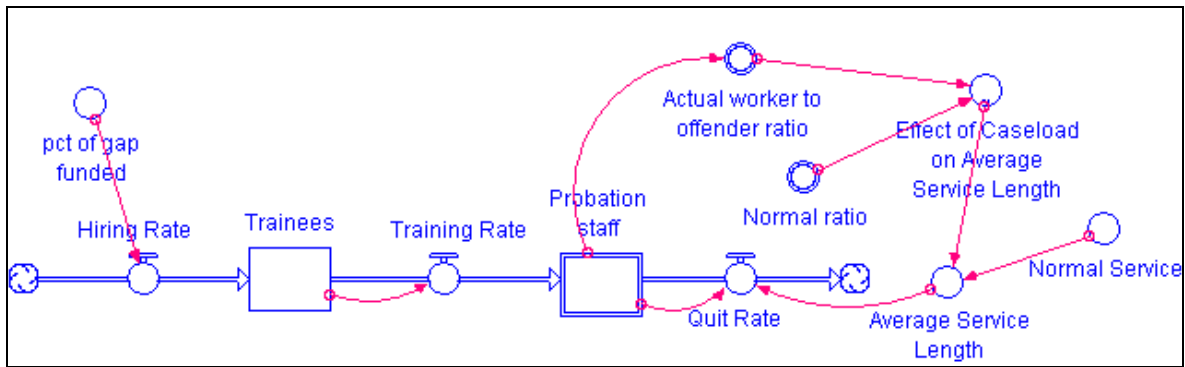

Figure 25: Simple Stock and Flow Structure: Probation Capacity

Aside from changes to names the probation capacity sector has only one change to the structure used in prison capacity structure. The average service length is a function of the staff caseload. The higher the caseload the shorter the average service length will be (Figure 26).

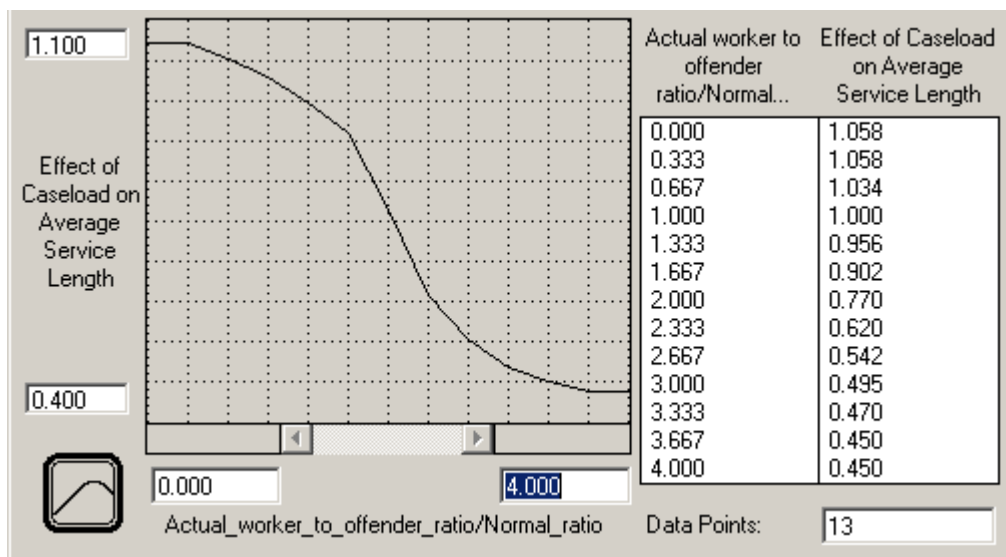

Figure 26: The Effect of Probation Officer Caseload on Probation Officer Service Length

Summary

This chapter has presented the building of the model from the initial hypothesis to the causal loop diagrams which defined the problem dynamically. The final section has detailed the actual structure built and explained why how we have interpreted the information from our literature review. We will now go on to show the most important validation points for the model.

Analysis

“The validation of a model is not that it is true but that it generates good testable hypotheses relevant to important problems.” Levins 1966 in Ford

“It is better to be almost right, than completely wrong” John Maynard Keynes

The goal of our model is to understand how real world structure is related to real world behavior. But the creation of model requires the reduction of the real world into a simplified understandable version of the real world. Each structure in the model has to be tested to ensure that it produces valid predictable behavior for any input. If the model can produce valid predictable behavior then we can have some confidence in it. If we have confidence in a model then we can begin to use it to improve understanding our of the real world. The virtual environment can become a testing ground for alternative strategies and behaviors that we wish to try out in the real world.

In this section we summarize the tests carried out both during and after the model building process. The section will cover several of the tests designed to ensure that model variables at least produce the behavior predicted in the hypothesis section. The testing will be divided down into two main sections, the first covering direct structure tests, and the second containing structure orientated behavior tests.

Direct Structure Test

Direct structure testing involves direct comparison of the behavior and parameters of the model to knowledge and information about the real system. Much of the direct structure testing of the model occurred as an integral part of the writing of the earlier sections of this paper.

The review of criminological literature on the subject of capacity utilization provided the basis for the model structure described in the hypothesis section. Each structure in the model has a basis in the literature: the structure of the prison population is based upon the concept of the bifurcation (Bottoms, 1983), the attitudes formed as a result of the crime level are based in Tim Newburn’s (2007) research, and the capacity sections are loosely based on Sterman’s (2000) supply chain models. Further checks on the structure of the

system were made through interviews with criminologists and the system dynamics team at the Ministry of Justice. Their contributions early in the development of the model have been invaluable in understanding which areas to could provide the most useful insights.

The model parameters were based on an extensive examination of the database of information available from the Home Office and Ministry of Justice. Wherever possible, real data was used to provide benchmarks, and test hypothesized behavior of the model during the building process. Within this research one of the largest problems of tackling overcrowding was uncovered: data inconsistency. In *all* the datasets there is a clear proviso that the individual parts of data sets will not add up the totals. For example the total number of people entering a prison cannot be established by adding together the sum of the categories for entry into prison. Methods and types of data have also changed regularly during the last 20 years. In order to minimize the problems caused by data errors we have attempted to match the home office data with data sets compiled by other authors in the field.

Structure orientated behavior tests

Sterman (2000) recommends several different kinds of structure orientated behavior tests. In this paper we have concentrated on testing how the system reacts from an equilibrium state to shock population inputs. To test the validity of our hypothesis key loops were cut out of the system cutting feedback loops¹¹. Details of extreme condition tests and sensitivity tests are contained in appendix 4.

Equilibrium shock test

The model was initialized in equilibrium¹². Applying a sudden shock of 1000 extra first offenders each year should cause prison capacity utilization to rise sharply, before falling rapidly to a value below 1. After this initial small disturbance capacity utilization will gradually rise to a higher peak, before slowly beginning to return to its equilibrium state.

This behavior was observed in Figure 27.

¹¹ In this paper we do not detail the cutting of loops: R1, R4, R5, B4 or B5. The effects of these loops were found to be very closely related to the effects of other loops in the system – so in the interests of space they have been excluded from the text.

¹² The attachments to this paper include a model designed with switches to set it in equilibrium, turn off model sectors, and apply shocks to the first offender flow, and the prisoner entry flows.

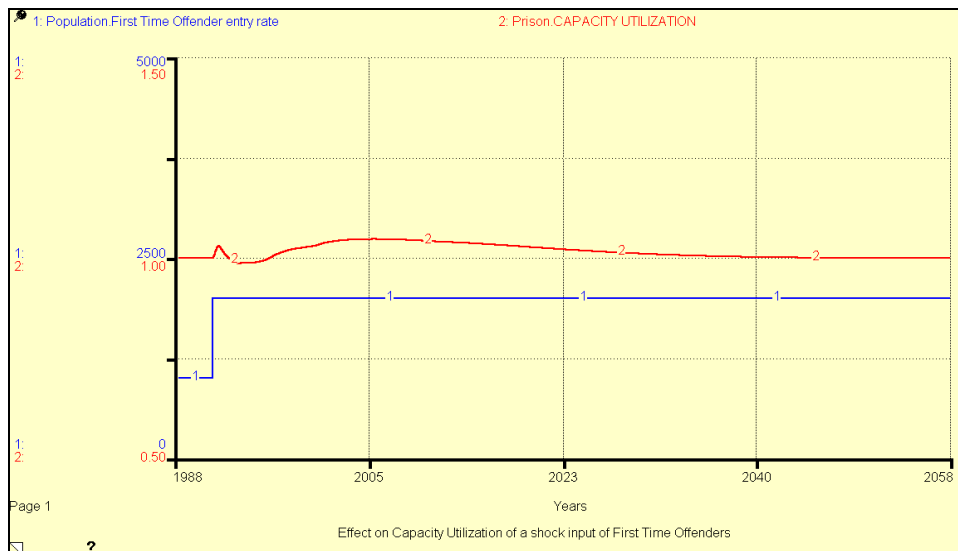

Figure 27: Response to a shock input

The initial spike in capacity utilization is the systems immediate reaction to the sudden increase in inflow. Capacity utilization's peak and fall occurs as capacity production increases to match the new population level. Population should also be reacting simultaneously to get back into equilibrium. During initial the period of increased capacity utilization, sentence lengths fall and recidivism rises. As recidivism rises, the judiciary imprisons a greater fraction of people, driving population upward. All the time prison capacity is trying to catch up to a previous level of population. The next sections will cut out individual loops to see how they contribute to the equilibrium shock reaction.

The Building Strategy Loop B1

According to the Building Strategy Loop B1, the increase of capacity should be a delayed reaction to the growth in the prisoner population. The size of the difference between the two stocks should affect the slope of capacity utilization. If our hypothesis is correct the rise in capacity utilization should coincide with an initial oscillation in prisoner population. The two stocks should eventually come closer together before both settling at a higher equal level. This was reflected in the behavior in Figure 28.

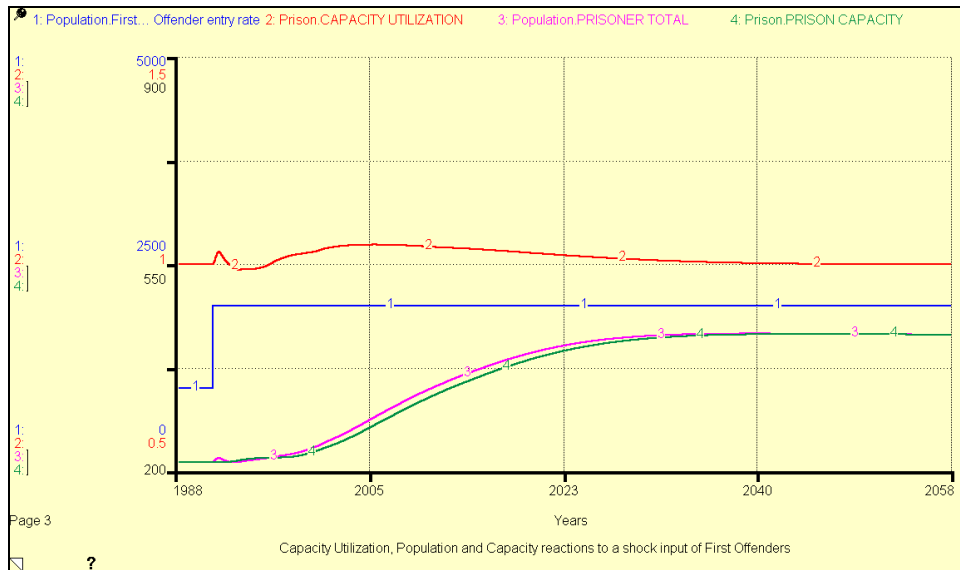

Figure 28: Relationship between stock reactions and capacity utilization

In order to see the effect of the Building Strategy Loop B1, we can cut the loops from the model. Cutting Loop B1 can be achieved by making the flows in and out of the stock of Prison Cells equal to the flows in and out of the Total Prisoner Population¹³. Cutting out loop B1 should put capacity utilization into a constant state of equilibrium, as the two stocks it is derived from now move in unison. This was observed in Figure 29.

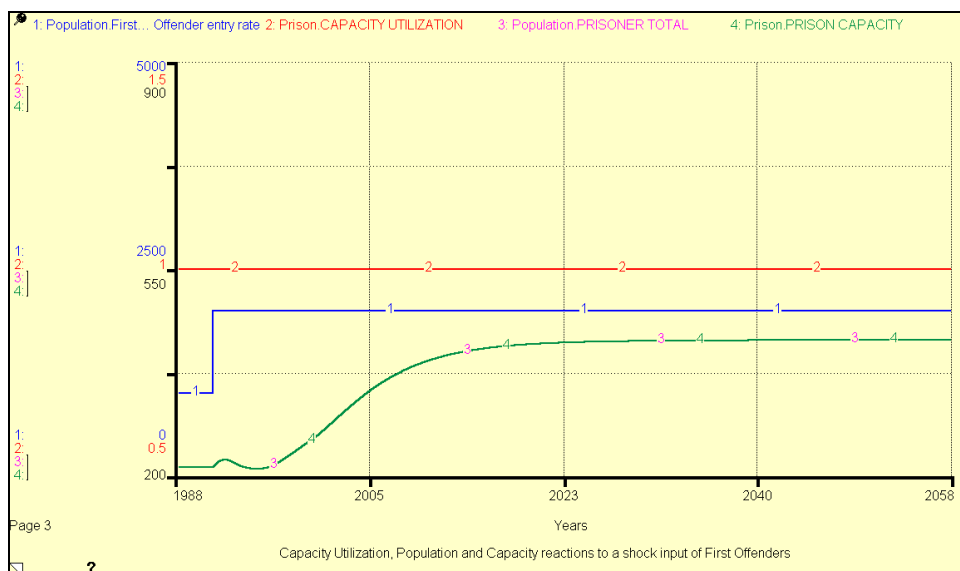

Figure 29: Cutting Loop B1

¹³ Equalizing the outflows is complicated by the presence of two stocks for the prisoner total. The problem is remedied, by making the capacity Depreciation Rate equal to the total of the Less Serious Offender and Serious Offender flows.

We can conclude from this that the delay times in Loop B1 and the forecasting methods used are at the heart of capacity utilization problems. As long as loop B1 is active, capacity utilization problems will occur whenever the number of prisoners changes. As a small experiment we reduced the gap adjustment time to 1 year. Lowering the gap adjustment time should create a system more averse to capacity shortages. This behavior was observed in Figure 30.

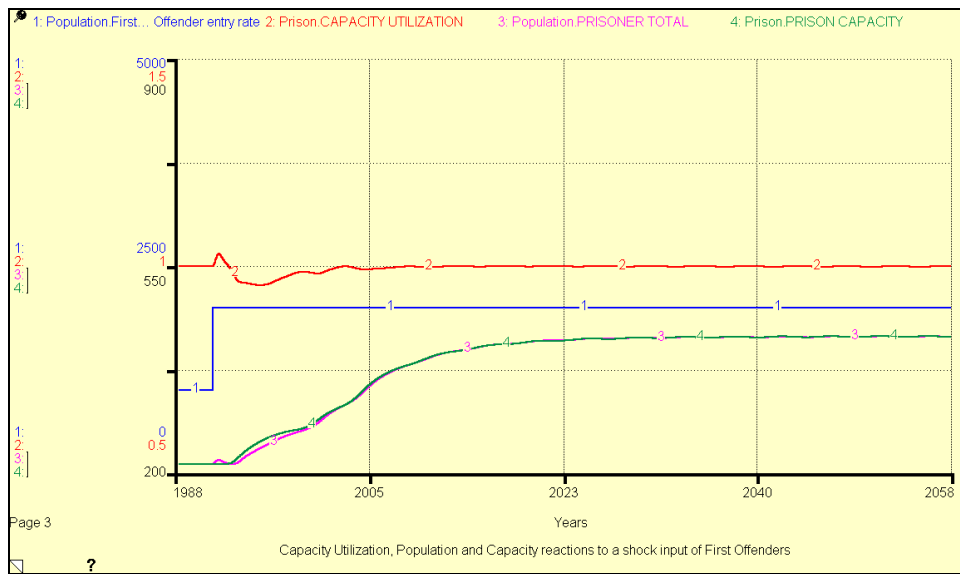

Figure 30: Behavior after reducing the gap adjustment time

Sentencing Strategy Loop B2

We hypothesized that high capacity utilization would shorten sentence lengths due to the Sentence Length Strategy Loop B2. We cut out loop B2 by setting the Capacity Utilization Effect on Sentence lengths to 1 to observe if this was true. The observations in Figure 31 support our hypothesis.

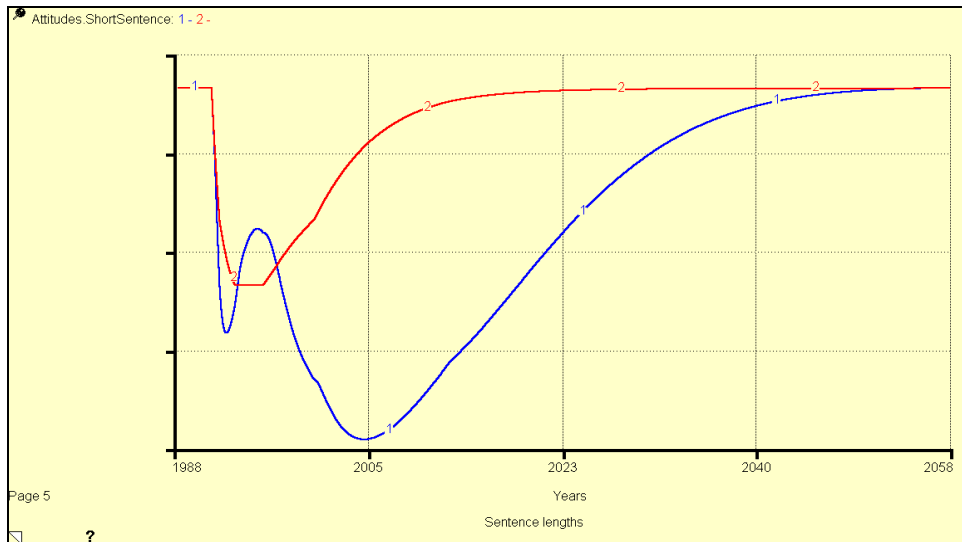

Figure 31: Sentence lengths with (1) and without (2) loop B2

The shortening of sentence lengths should lead to a smoothing out of disturbances in capacity utilization, so the amplitude of the capacity utilization behavior should be greater without loop B2. This was observed in Figure 32.

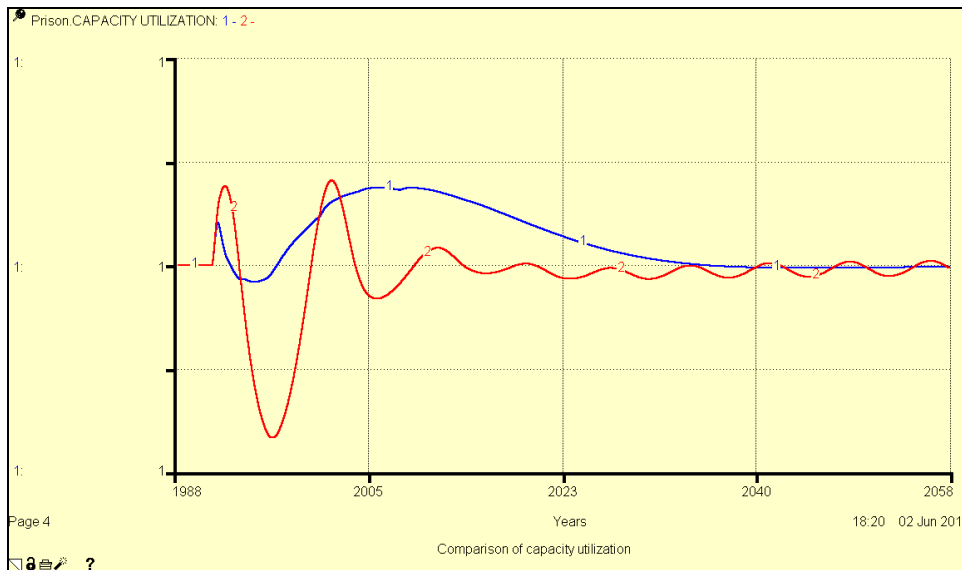

Figure 32: System behavior with (1) and without (2) Loop B2

The level of oscillation in Figure 32 signifies that loop B2 is a strong lever in the control of capacity utilization. According to our hypothesis loop B2 acts to stabilize population levels. The more stable population is the more stable both capacity and capacity utilization will be. Without Loop B2 the oscillations in population, are worsened by the delay in constructing new cells.

Cutting the Rehabilitation Strategy Loop B3

According to our hypothesis there are additional influences on sentence length operating through recidivism and rehabilitation. Recidivism is controlled by two loops: The Rehabilitation Strategy Loop B3 and the Punitive Focus Loop R2. We tested the effects of these loops by cutting off one loop at a time.

Loop B3 was cut by setting the two completion ratios to their equilibrium values. Cutting here assumes that amount of rehabilitation successfully performed in prison is unaffected by sentence length changes. We predicted that cutting loop B3 would cause a drop in recidivism. With loop B3 active sentence lengths were allowed to fall below their equilibrium value. With lower sentences, the amount of rehabilitation that can take place was been limited. When we removed loop B3 the predicted drop in recidivism was observed (Figure 33).

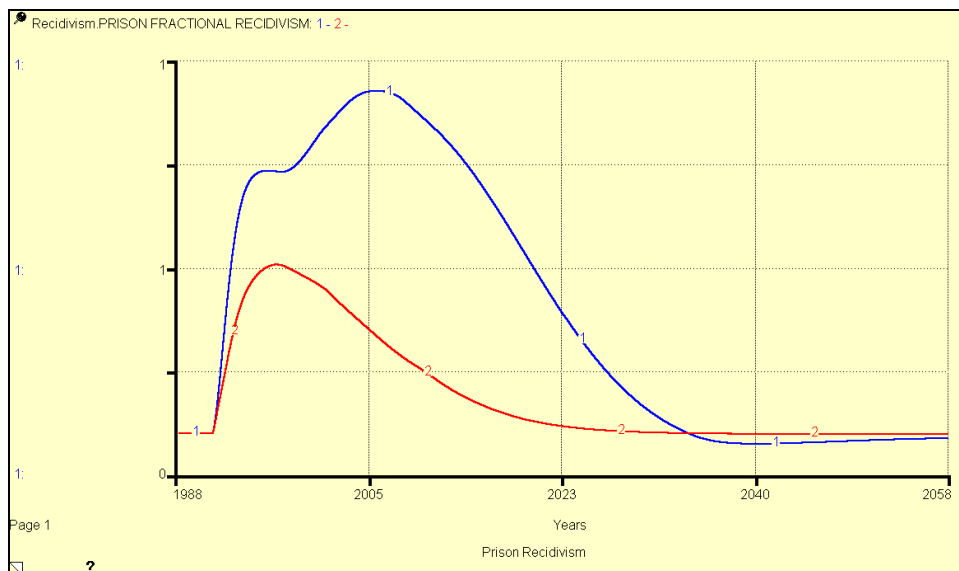

Figure 33: Recidivism with (1) and without (2) loop B3

The effect on capacity utilization, of cutting loop B3, should be a lower amplitude but a longer duration of time spent with capacity shortages. This behavior was observed in Figure 34 - capacity utilization does not return to its equilibrium state until 2097 (beyond the scale of Figure 34).

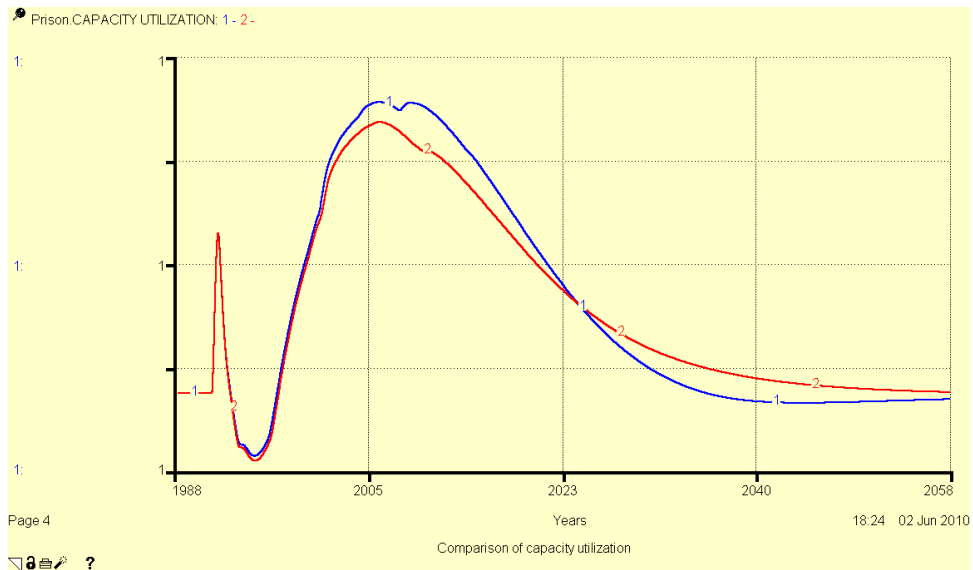

Figure 34: Capacity Utilization with (1) and without (2) loop B3

Cutting the Punitive Focus Loop R2.

Next loop R2 was cut by making the values of the non linear table function, Capacity Utilization Effect on Rehabilitation Delivery equal 1. Cutting Loop R2 rehabilitation should allow rehabilitation to take place without concern for capacity constraints. As a result recidivism should be lower and sentence lengths will also be lower. Whilst recidivism was indeed lower (Figure 35), there was only a minimal impact on capacity utilization. The impact on capacity utilization was not any greater with a higher offender completion ratio.

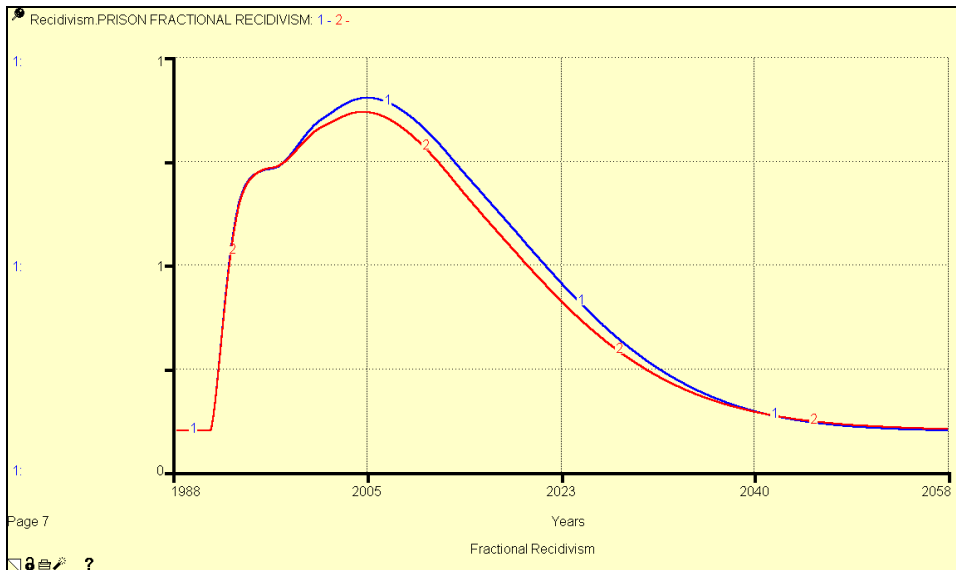

Figure 35: Fractional recidivism with (1) and without (2) Loop R2

Cutting the punish recidivism loop R4

Recidivism usually increases the number of people going to prison. So with loop R4 switched off the amplitude of capacity utilization problems should be less severe. Loop R4 was cut by setting the imprisonment fraction to its equilibrium level of 0.27. Our predicted behavior was observed. Capacity utilization without loop R4 had a less aggressive reaction (Figure 36).

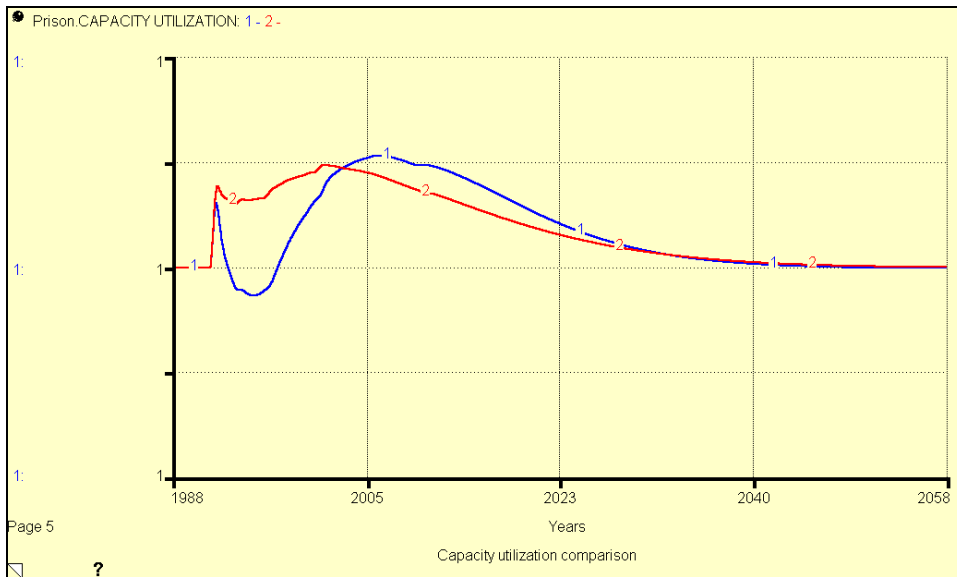

Figure 36: Capacity utilization with (1) and without (2) loop R4

The capacity utilization behavior occurred because of the differences in the prisoner population behavior (Figure 37).

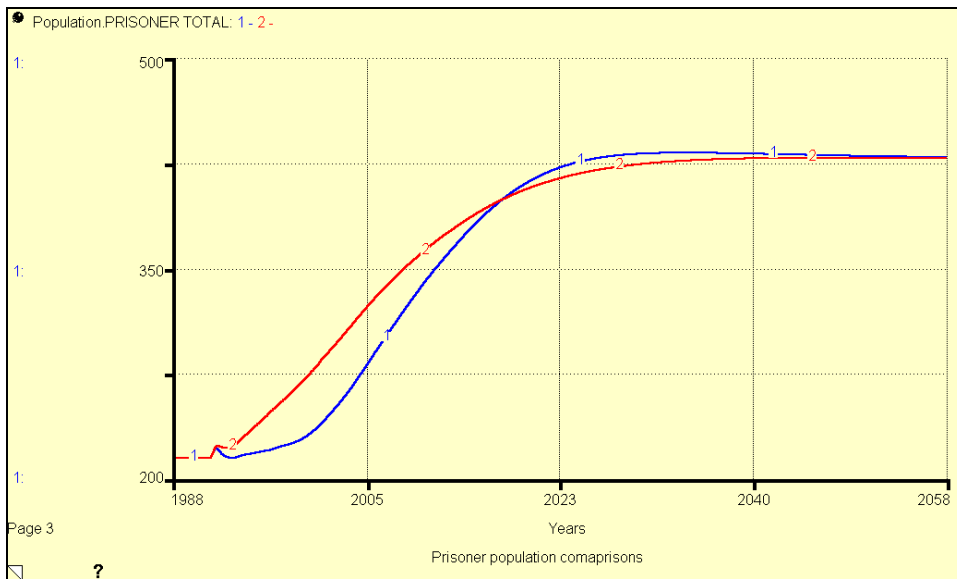

Figure 37: Population comparison with (1) and without (2) loop R4

The differences in population development were partially caused by changes to recidivism.

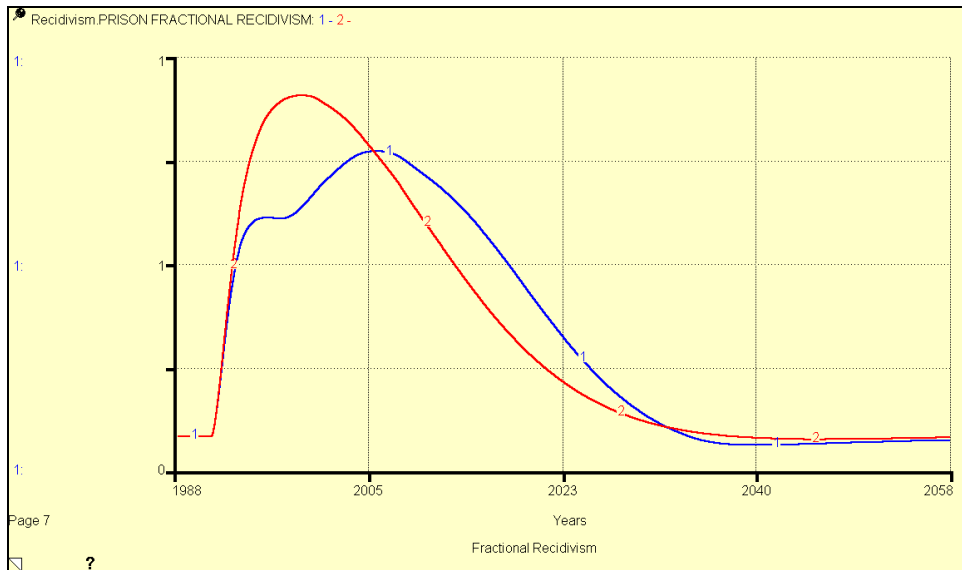

Figure 38: Prison fractional recidivism comparison with (1) and without (2) loop R4

Cutting Loop B6

The cut to Loop R4 also affects probation; as loop B6 is cut automatically. It was predicted that the probation system population would grow much slower if there were no changes to the imprisonment. This behavior was observed.

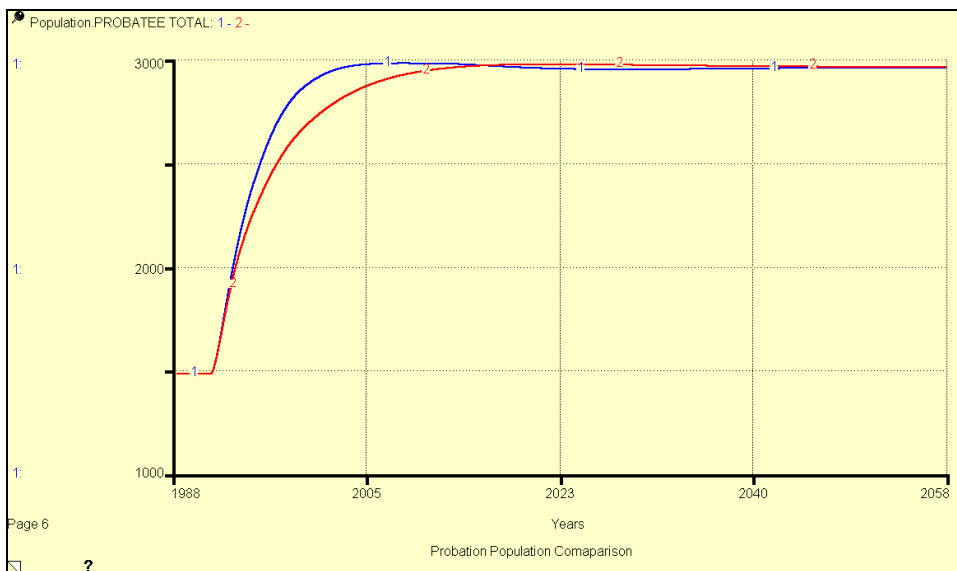

Figure 39: Probation population with (1) and without (2) loop B6

Cutting Loop R7

Cutting loop R7 the probation hiring strategy loop can be achieved in the same manner as the cutting of loop B1. The in and outflows for the probation population were made the same as the in and out flows from probation multiplied by the desired worker/offender ratio. The results from equalizing the probation capacity and population should have very interesting implications for *prison* capacity utilization. We believe that cutting loop R7 will cause prison capacity utilization to be much lower. This was observed in Figure 40.

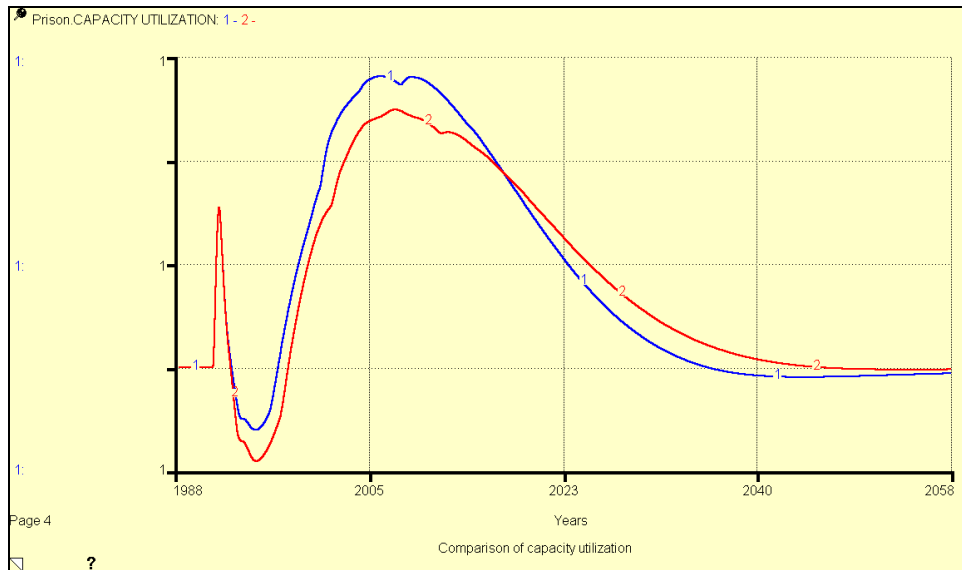

Figure 40: Comparison of prison capacity utilization with (1) and without (2) loop R7

The logic behind this reduction in capacity utilization can be found by considering the imprisonment ratio. The equilibrium imprisonment rate is 0.27, meaning that 73% of offenders are headed towards probation. Reductions in probation fractional recidivism will therefore have a larger impact on the inflow to the prison system than reductions in prison recidivism. Removing the delay from loop R7 improves the worker to offender ratio, which reduces probation fractional recidivism (Figure 41).

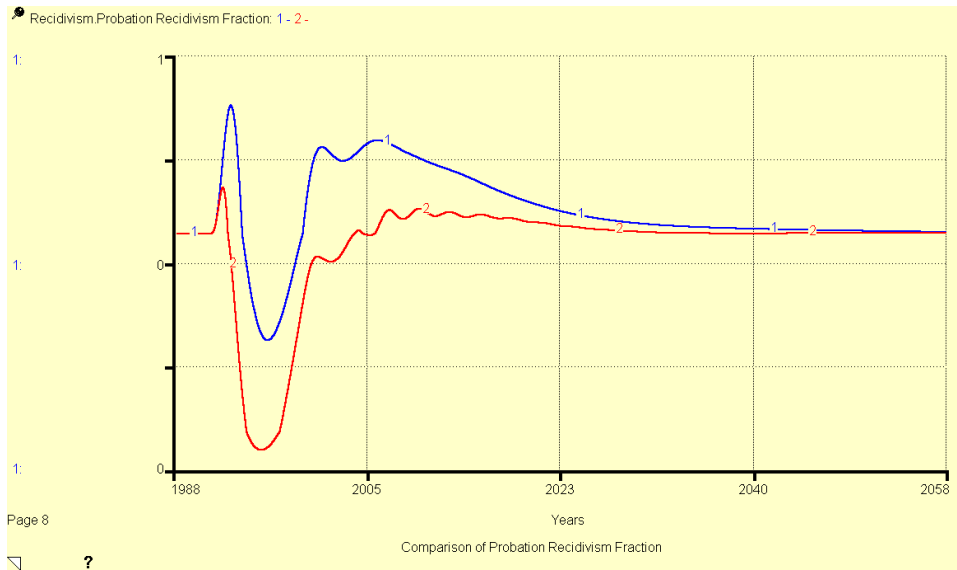

Figure 41: Probation Fractional Recidivism with (1) and without (2) loop R7

Sensitivity analysis

Building Delays

In line with my hypothesis, cutting loop B1 showed that the model was potentially sensitive to changes in the delay times in the building module. Sensitivity analysis was conducted on the construction time for prisons. Construction times of 1 year, 3 years and 5 years were tried. The difference was very small indicating low sensitivity to building changes.

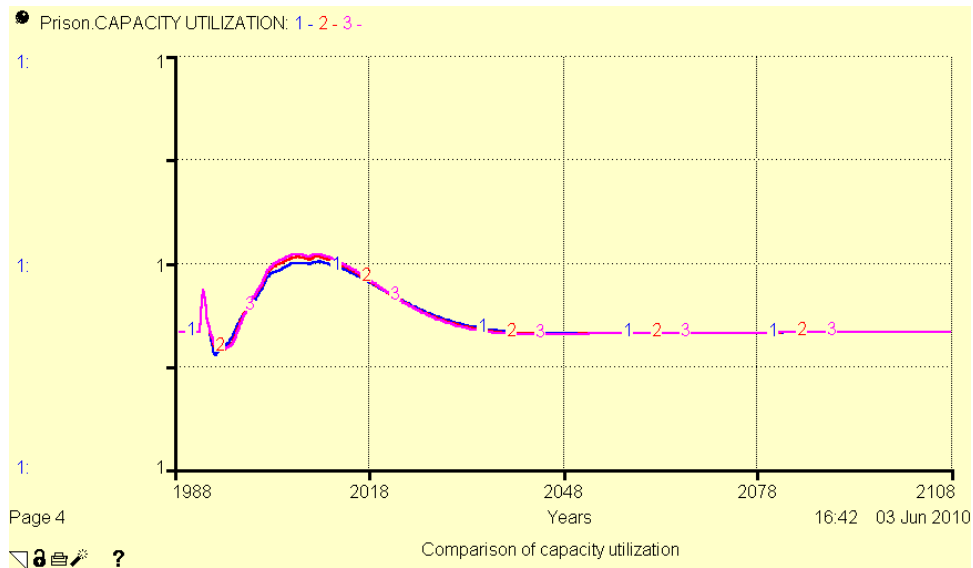

Figure 42: Sensitivity to changes in construction time

The same test was also run on the capacity adjustment time. The capacity adjustment time produced more dramatic differences. Most notably with an adjustment time of 1 year the system becomes unstable. Reducing the capacity adjustment time has the potential to reduce capacity utilization quickly, but the very speed of this reaction could cause difficulties of overcompensating and the building of excess cells.

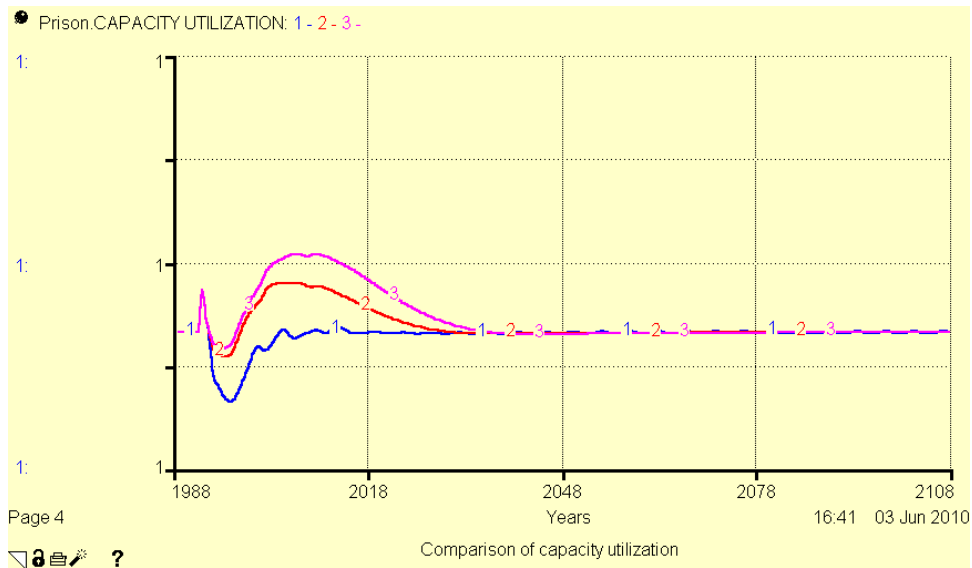

Figure 43: Sensitivity analysis on Gap Adjustment time

Rehabilitation schemes

The model was tested for its sensitivity to the effectiveness of rehabilitation schemes. Sensitivity ran at intervals of 33.3%, from 0% effectiveness to 100% effectiveness. As expected, higher levels of effectiveness from rehabilitation reduce the levels of capacity utilization further. However in the long term the gain from 0% to 33.3% and from 33.3% to 66.7% are far greater than those from 66.7% to 100% rehabilitative effectiveness. In the long term any increase in rehabilitation's effectiveness does have benefits.

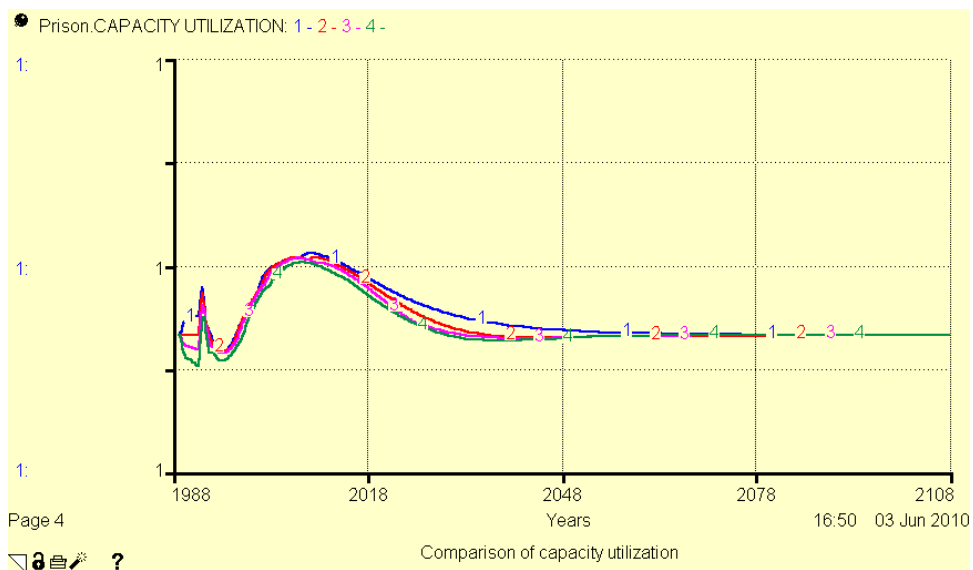

Figure 44: Sensitivity analysis to changes in rehabilitation (0%, 33.3%, 66.7%, 100%)

If we assume 100% effectiveness from rehabilitation schemes and change the effect of capacity utilization to a flat value, we can see how sensitive the model is to this parameter. We ran sensitivity at values of 1, 0.75, 0.5, 0.25, and 0. The effect of capacity utilization had a visible effect on reducing capacity utilization.

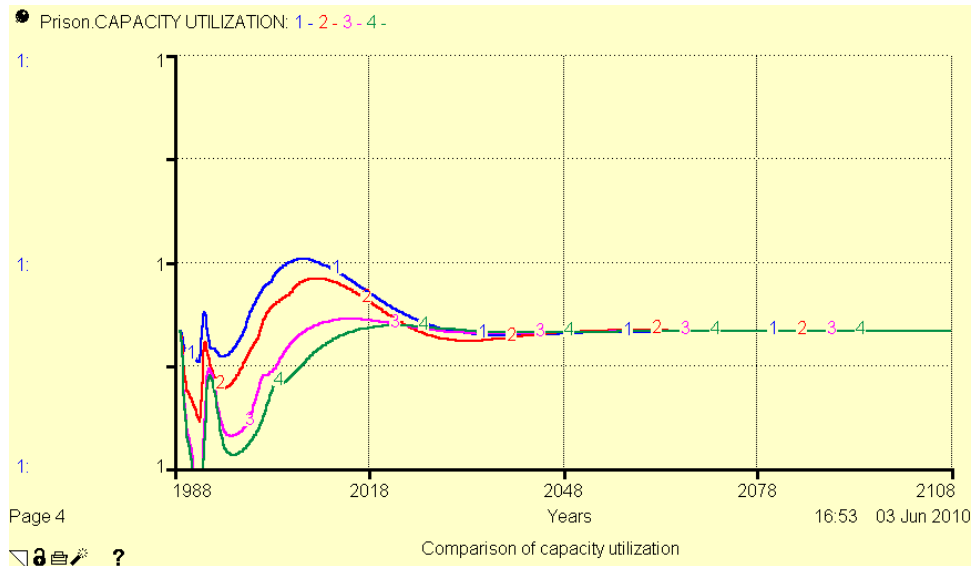

Figure 45: Sensitivity to different flat rates in capacity utilization effect on rehabilitation

The results of this test suggest two alternatives: if rehabilitation can be delivered in a shorter time or if sentences can be lengthened; real gains can be made in capacity utilization control through improved rehabilitation.

The probation workforce adjustment time

As the majority of people are going through probation cutting recidivism in this area should produce significant reductions in the flow of recidivists into the prison system. It is possible that the effect on capacity utilization on from these gains will be greater than that from direct action in the prison system.

We ran a sensitivity analysis on a workforce adjustment time of 1 year, 3 years and 5 years (Figure 46). The capacity utilization was sensitive to changing the adjustment time. Longer adjustment times led to shorter but more amplified reactions to the initial shock.

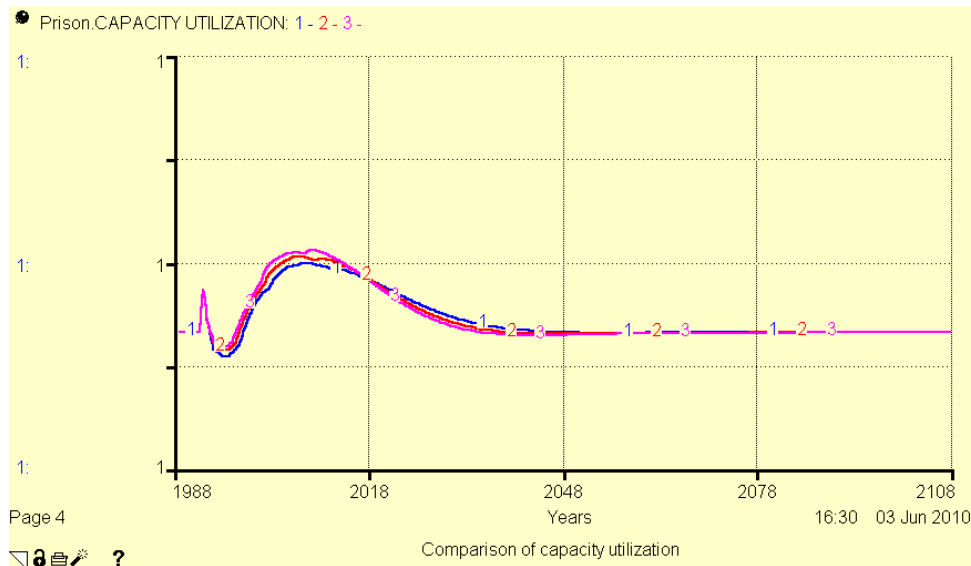

Figure 46: Capacity Utilization sensitivity to changes in probation workforce adjustment time

The Time to Change Recidivist Perception

Changing the adjustment time for the recidivist perception should have a dramatic effect on capacity utilization. The longer reaction times are the longer the duration of disturbances to capacity utilization and the lower the aggressiveness of the capacity utilization reaction. The changes in capacity utilization are rooted in the changes caused to sentence lengths, offence seriousness and the imprisonment fraction. All three of these variables should be smoothed by a longer adjustment time.

The behavior predicted in capacity utilization was observed in the equilibrium shock test.

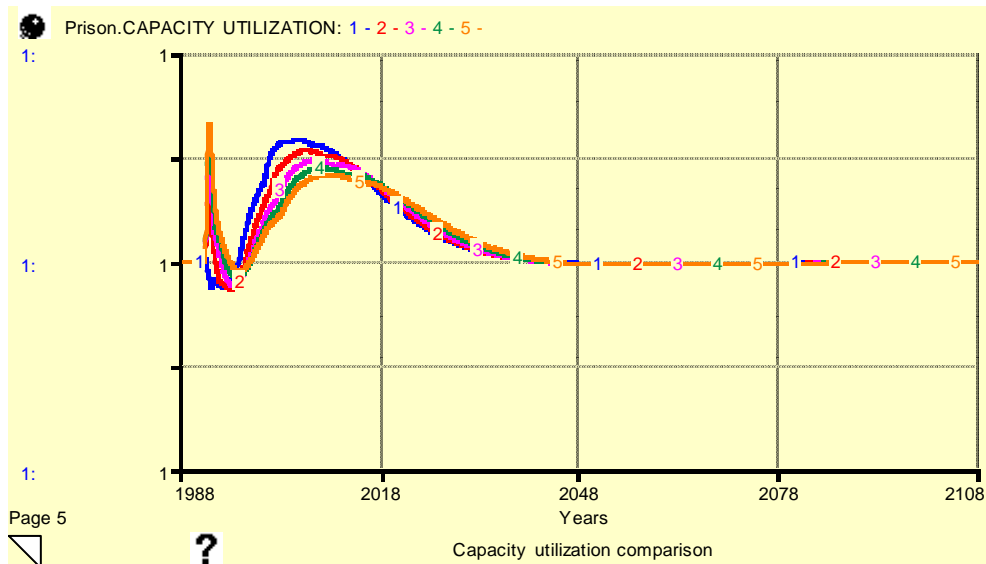

Figure 47: Capacity Utilization reaction to changes in perception of recidivism adjustment time

Testing table functions

The next section goes through the table functions used in this paper and provides justification for the influence of these functions. The curve of a table function reflects a parameter assumption that needs to be tested like any other assumption. We detail the tests undertaken on three table functions: the effect of political punitiveness, the effect of the recidivist fraction on the judiciary, and prisoner perceptions of the benefits of crime. Wherever a selection of curves is presented the final curve in the sequence is always the one used in the model.

Effect of political punitiveness

Three different policy curves were tried for the effect of political punitiveness (Figure 48). No significant difference to the development of capacity utilization or the prisoner population was observed by changing the policy curve. The third curve was used in the model. It was felt to accurately reflect the limits of leniency and harshness within which politicians must reside. In the current model this table function provides the only avenue for politicians to exercise restraint in legislation. It was felt that the restraints on political punitiveness could be adequately explained by this curve. However a future exploration of the structures limiting political punitiveness would be an interesting future model task¹⁴.

¹⁴ Any such analysis should include seasonal economic constraints, as well as using capacity utilization as a measure of humanitarian constraints on the growth of political punitiveness.

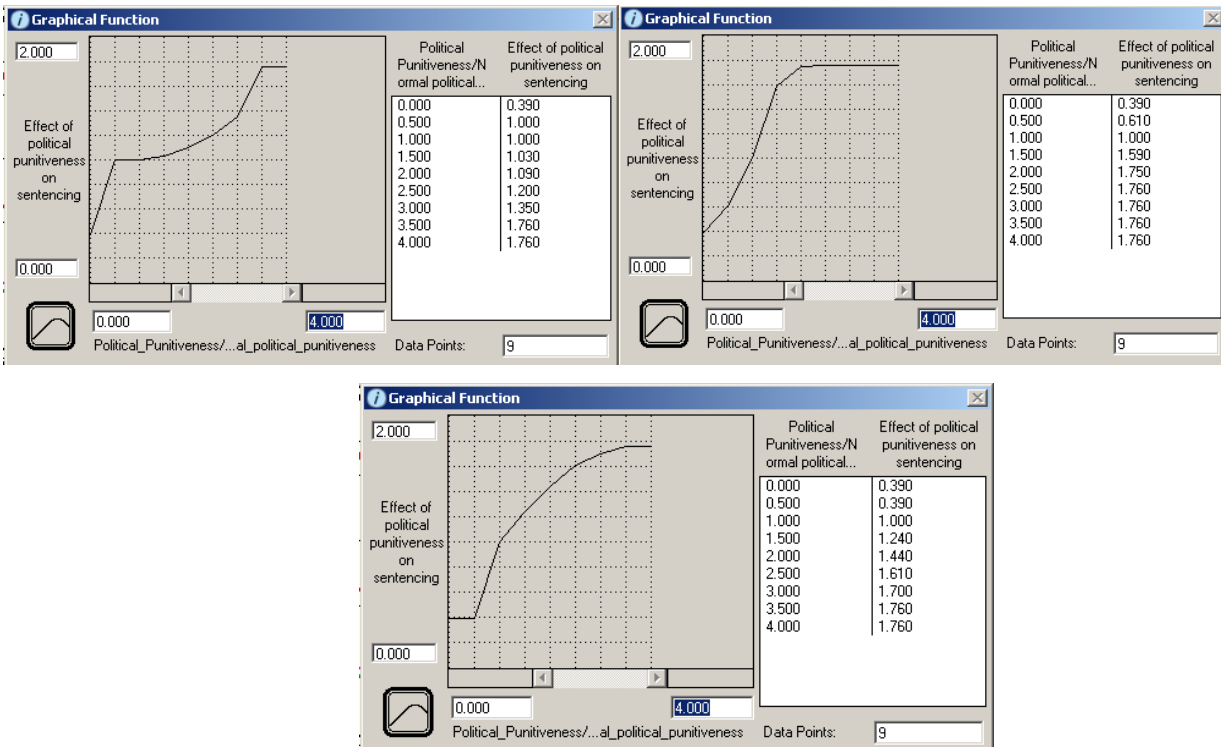

Figure 48: Different policy curves for the effect of political punitiveness on sentencing

The effect of the recidivist fraction on the judiciary

The effect of the recidivist fraction on the judiciary has a significant effect on sentence lengths and recidivism; however it had only a minimal impact on the actual behavior of capacity utilization and population. Three different curves were tested (Figure 49). The third curve was used in the model. The table function used in the model was settled upon using Stephenson’s (1999) description of the behavior of the judiciary. The curve represents the conservative nature of the judiciary, less inclined to rapid changes in punitiveness. The thresholds for the effect on judicial punitiveness were also set quite narrowly, representing the limits imposed by legislation on judicial decision making. If any further harshening were to take place it would have to come directly from the legislation. Similar reasoning was used to choose all three curves relating to the influence of recidivism on judicial sentencing

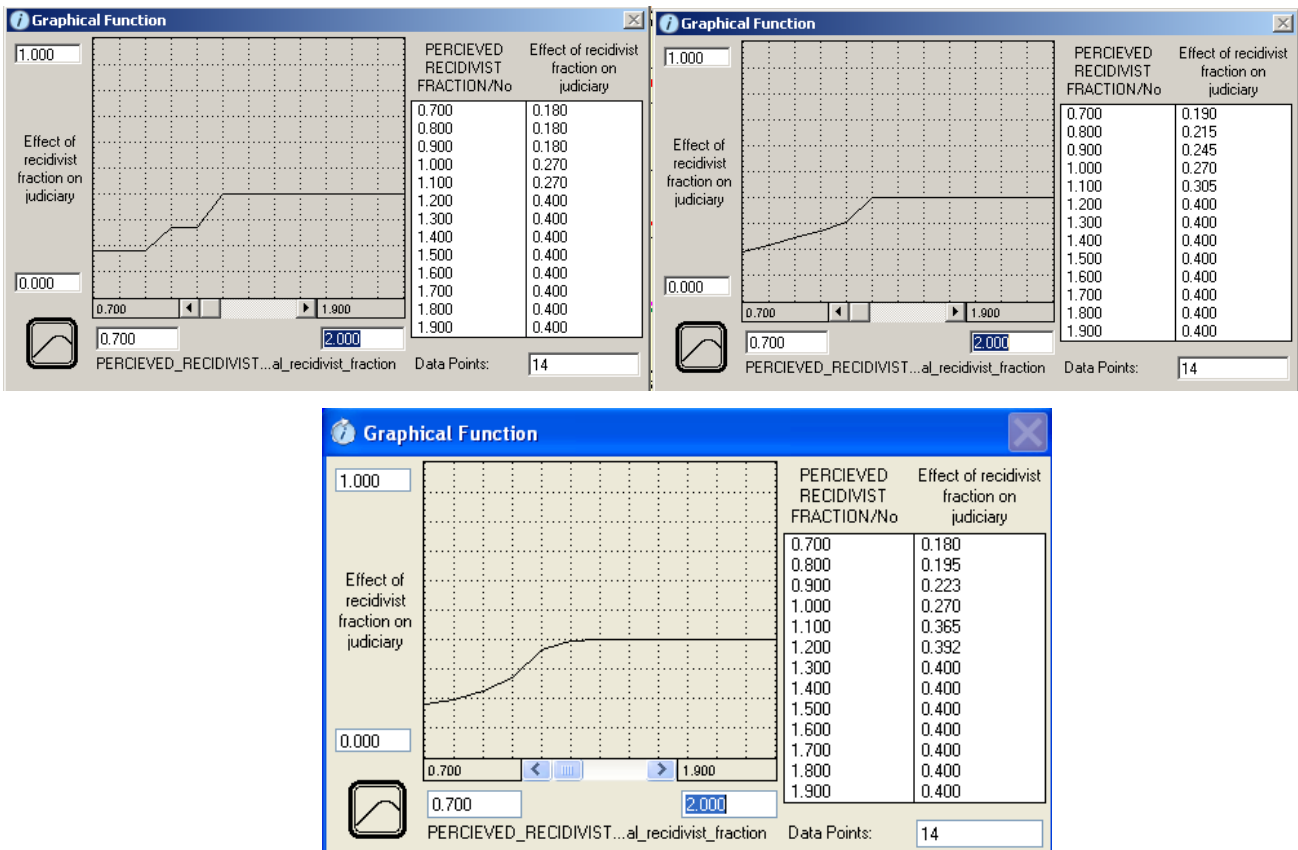

Figure 49: Different policy curves for the effect of recidivist fraction on the judiciary

Prisoner perception of the benefits of crime

Changing the shape of the curve for the perceptions of crime was found not to alter the behavior of the system. We used the third curve the step incline followed a slower more gradual rise is indicative of a situation where more crime equates to more benefit, but the increase in benefit from crime diminished as more crime is committed in society (Figure 50).

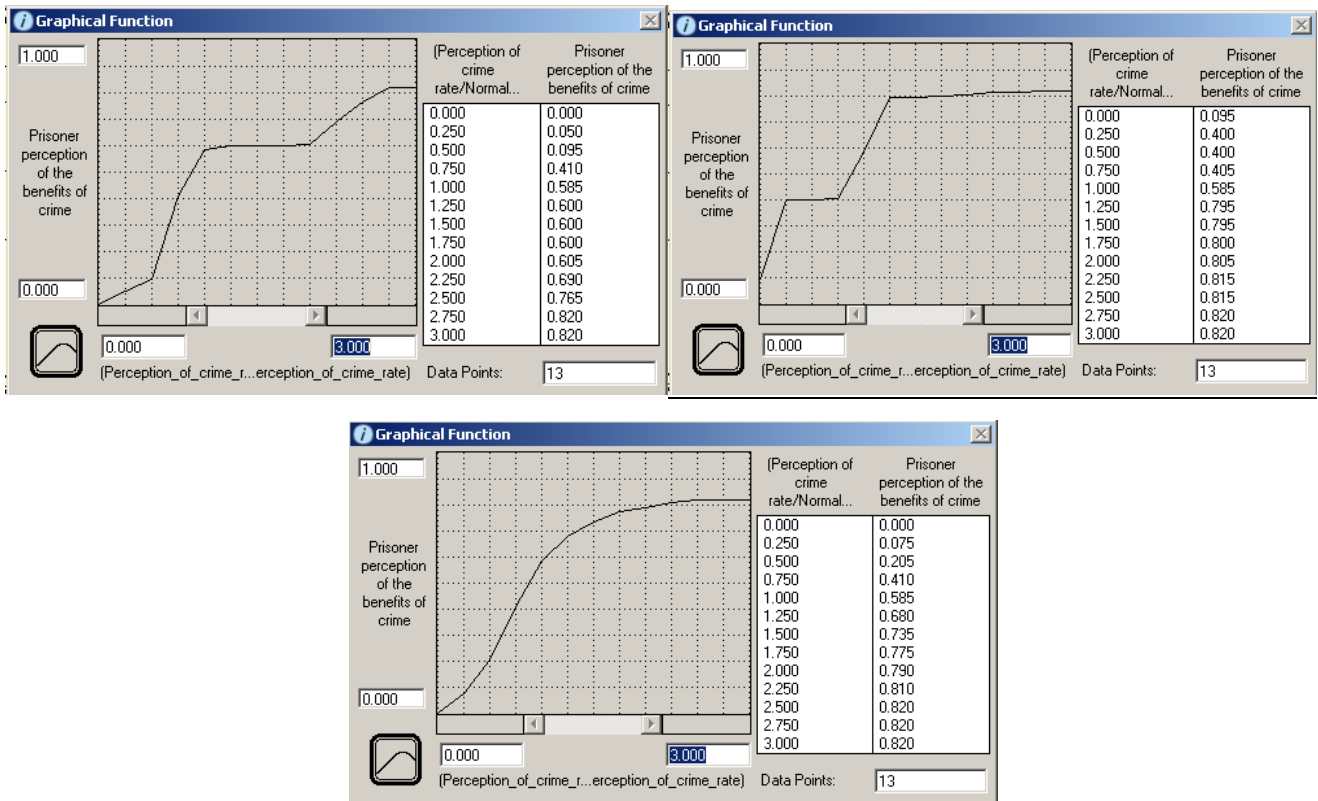

Figure 50: Different policy curves for prisoner perception of the benefits of crime

Capacity utilization effect on sentence

Changing the curve of the capacity effect on sentence length can significantly alter the amplitude of the capacity utilization behavior. The current curve was chosen as it appears to be the best fit to the use of early release programs since 1990. Alternate curves could provide a good guideline for establishing clear policy on how early release schemes would be used in future. Having an agreed upon plan in place may make the use of early release use slightly less controversial.

Integration method and Choice of DT

A DT set to 0.025 provided stable results.

The oscillatory nature of overcrowding suggested using Runge Kutta integration, however as some logical functions are used in the model Eulers integration method was used.

Recreating the reference mode

In this section the model was initialized with historic data wherever possible. Where data was not available estimates of historic values were used. Using historic estimates allows comparison between the behavior of the variables of interest the historic behavior.

According to the criterion in Theil's hypothesis we can judge the fit to the reference mode on three criteria: bias, variation and co-variation. Little bias was found in the model (Figure 51). The historic and modeled behaviors were found to have a similar mean value. The historic and modeled behaviors were found to co-vary very well, a point to point correlation was found between the majority of variances. There were some issues with matching the amplitude of variations. The differences in amplitude variation were not thought to be of significant harm to the validity of the model.

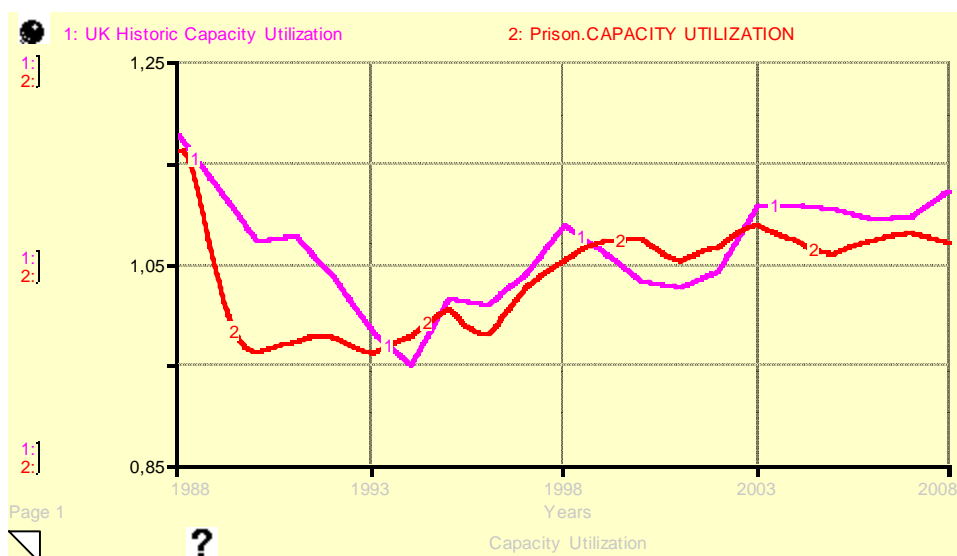

Figure 51: Historic (1) and modeled (2) UK capacity utilization

Comparison of historic and modeled population and capacity behavior

The problems with our data fit became more easily understandable when we examined population and capacity separately. The trend in population development was similar to the historic trend however an initialization problem was apparent in the 1988 to 1992 period and there is a clear issue reproducing the population growth around 1997 (Figure 52). Sensitivity analysis indicated that the initialization problem is related to the perception of recidivism (appendix 5). The length of the perception of recidivism adjustment time was found to affect the initial fit.

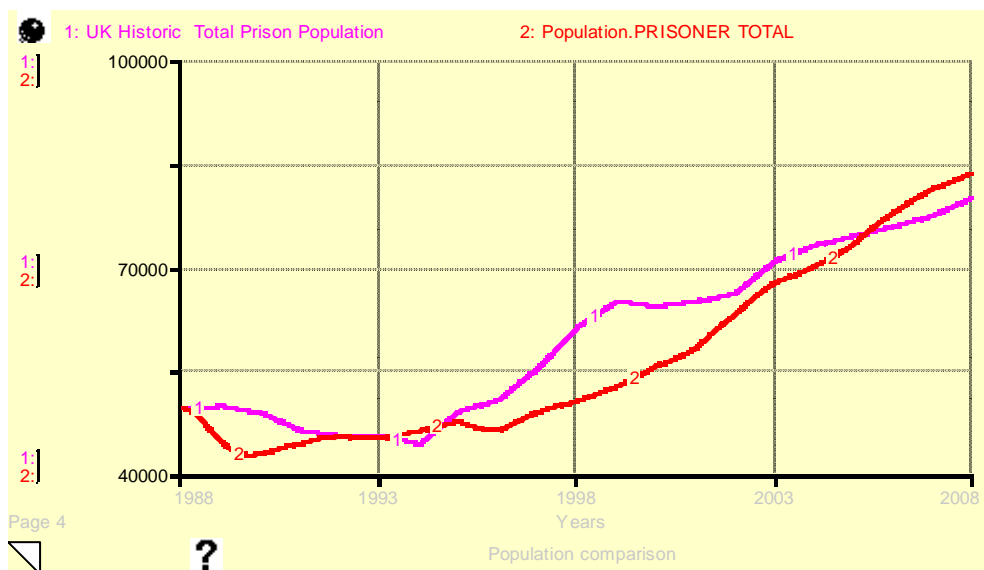

Figure 52: Historic (1) and modeled (2) population development

The fit to the 1997 period is a problem which we have faced in every version of our model. It occurs in the reproduction of both population and capacity (Figure 53).



Figure 53: Historic (1) and modeled (2) capacity development

What is apparent from seeing these two graphs is that in the development of capacity is a smoothed version of the historic trend in population development (Figure 54).

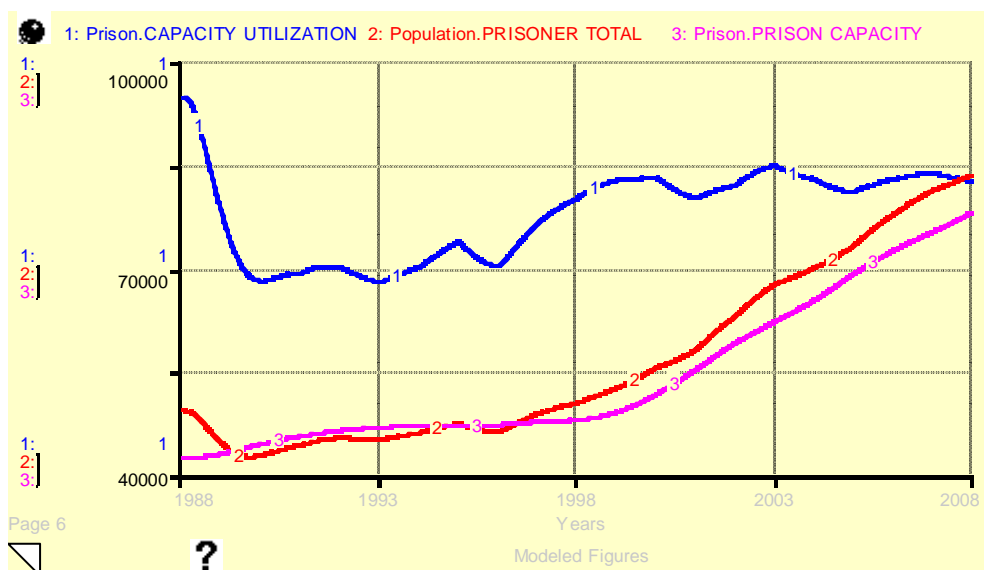

Figure 54: Reference mode reproduction

Though our population development does not completely track the amplitude of the movements in the historic trend we feel that the reference mode behavior achieved in the model is sufficient to assume that there is some validity in the assumptions of the model. A model that produces partial results can in fact be more useful than a model that exactly reproduces the reference mode. The ultimate concern of this model is that capacity and

population react together. Though the current model is far from a complete picture of the prison system we can still draw useful insights from the model which may be hidden in the real world due to the complexity of the system.

Reference Mode Sensitivity to changes in the perception of public, and political adjustment times

In our hypothesis section we converted Newburn’s (2007) hypothesis that incarceration rates reflected a delayed perception of the crime rate to a modeled structure. Due to the method chosen to shock the system we realized that the effect of changes to the public and political perception adjustment times could not be observed.

To understand how public and political adjustment times affected the model behavior we ran the model from its historic values to test how sensitive the system was to changes in these adjustment times¹⁵. The results were a partial match to the evidence in the literature and guided our choice of parameter values. We predicted that the system would be most sensitive to changes in the time to perceive changes in crime. Changes in the time to perceive changes in crime will have a double effect: changes to public punitiveness will alter sentence lengths and changes to offender perceptions of crime will reduce recidivism. The predicted behavior in capacity utilization was observed (Figure 55).

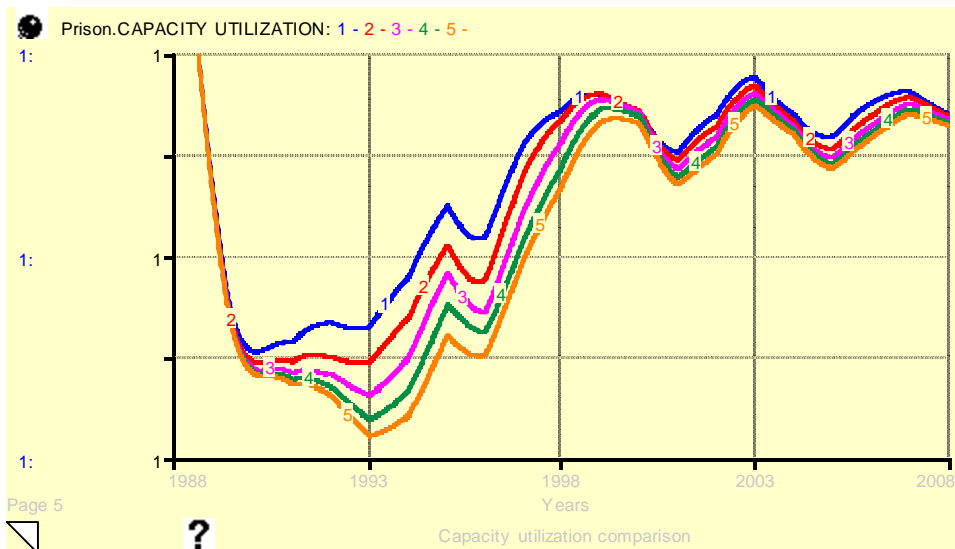

Figure 55: Capacity utilization sensitivity to changes in the time to perceive changes to the crime rate

¹⁵ Brief tests were also run to test the equilibrium reaction to a shock in the crime rate. These are not detailed in the paper as it was felt that the sensitivity in reference mode replication provided sufficient information.

There was a more subtle but significant reaction to changes in the time to change public punitiveness. The results indicated that the longer the time to change public punitiveness, the less volatile the resulting capacity utilization behavior (Figure 56).

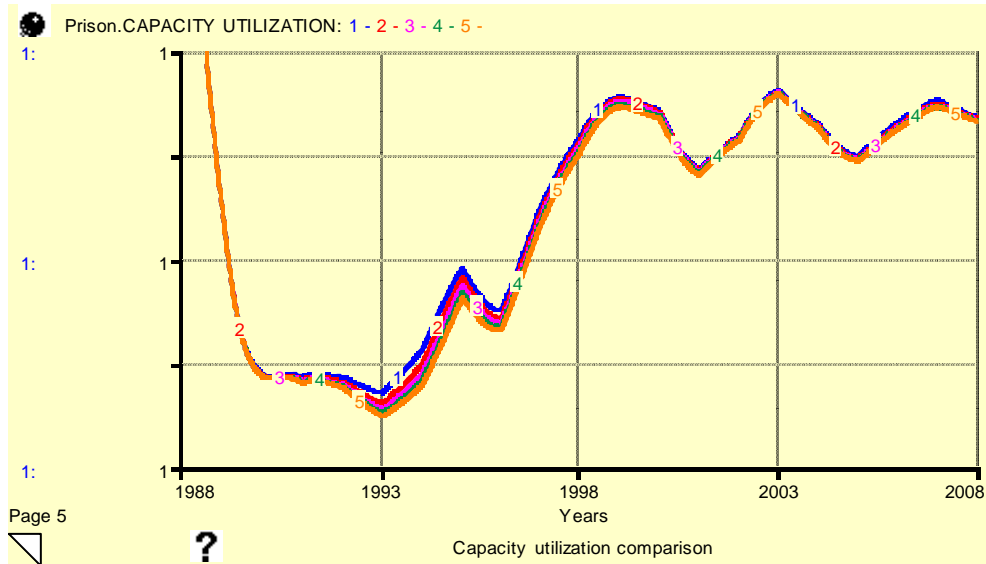

Figure 56: Capacity Utilization sensitivity to time to change public punitiveness.

Capacity Utilization was less sensitive to changes in the political punitiveness adjustment time.

Policy

The policy tests in this paper fell into two groups: policies aimed directly altering prison capacity, policies aimed at directly or indirectly controlling the population. In both cases it must be remembered that these are policies must fall under the control of the National Offender Management Service – which excludes direct control of variables such as the crime rate, inflow of first time offenders and sentence lengths. The three policies tested¹⁶ were the quick build strategy, improving rehabilitation, and custody extra.

Policy Option 1: The Quick Build Policy

Our literature review, hypothesis and analysis all point to the building loop B1 (Figure 5) as a key factor in the control of capacity utilization. Policy 1 or “the quick build strategy” is an extension of a study done in 2005 by Bourne. We have followed the data in Bourne’s (2005) paper to add a policy to build units that have shorter construction times than specially designed prison units. The policy comes into effect whenever capacity utilization is high.

Policy Option 2: Improving Rehabilitation Policy

Capacity utilization problems can also be addressed by looking at the input of offenders. The editor of the prisons Handbook recently commented the “*targeting reoffending has got to be the cornerstone of the prison service. If a hospital discharged patients and 67% came back with the same illness we’d close down the hospital*”(Leech, 2010). In our literature review and hypothesis sections we laid out the argument that recidivism was one of the major causes of the acceleration in the prison population that is part of the reason for our current capacity utilization problems. The first policy we will try in this area (Policy 2) is to increase the effectiveness of rehabilitation.¹⁷

Policy Option 3: Custody Extra

Policy 3 is an extension of a combination policy that is currently being tried in areas on England. Our policy is called “Custody extra”. Offenders serve their sentences part

¹⁶ An additional policy, the “state of emergency policy” was also tested and is detailed in appendix 6

¹⁷ The next step would be to cost all of this policy and give a cost effectiveness analysis to see what the costs would be to make such a reduction in recidivism. There have in fact been recent calls for exactly this to be done.

time but over a much longer period. For example they spend half of the week in prison but are allowed to be monitored at home for the other days. They are able to continue working etc under this type of scheme, and more importantly to maintain family ties. As their sentences stretch for longer they are more likely to finish rehabilitation schemes.

Analysis of the Quick Build Policy

We have interpreted the Quick Build policy by adding a new structure (Figure 57).

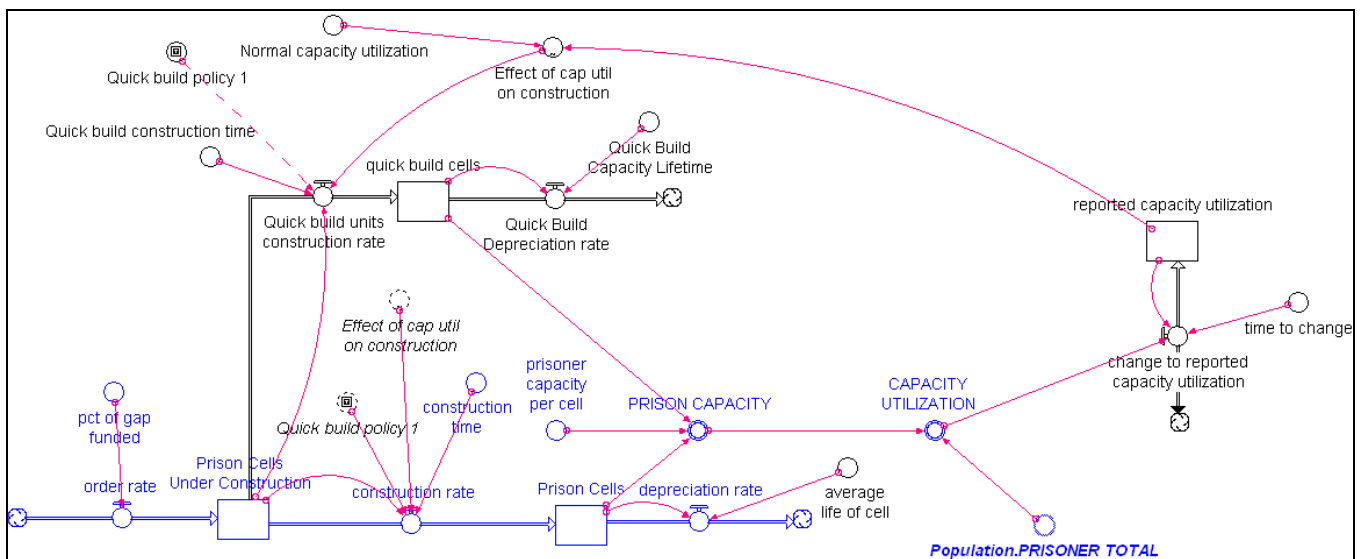

Figure 57: Quick build policy structure

A second outflow called the Quick Build Units Construction Rate (QBUC) is added to the prison cells under construction stock. Capacity utilization is run through a delay to allow it to be reported. Once capacity utilization exceeds the value of one the QBUC rate kicks in. The QBUC rate has a shorter construction time than the ordinary construction rate, so should allow faster compensation for capacity problems.

The effect of Capacity Utilization on Construction converts a maximum of 10% of all normal construction to Quick Build units. The effect begins whenever capacity utilization exceeds 1. As capacity utilization worsens the proportion increases (Figure 58).

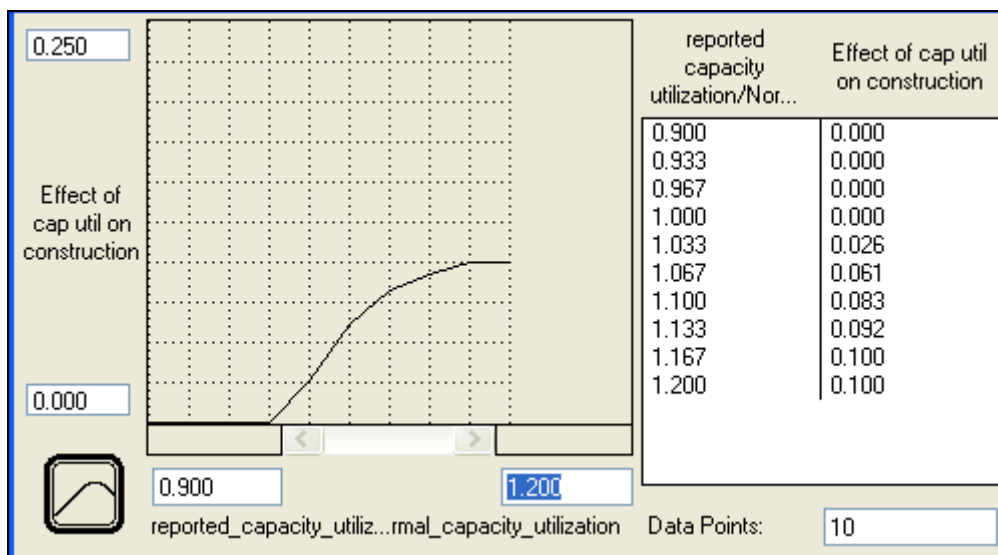

Figure 58: Effect of capacity utilization on construction

Quick build cells have a lifetime of 30 years rather than the 60 years (Bourne, 2005). We also feel that the adjustment to the lifetime of prison capacity could at least partially represent the extra strain put on the existing infrastructure – ie plumbing, heating etc of the existing blocks. The pricing implications of these types of cells have been evaluated, and they have proven to be competitive (Bourne, 2005).¹⁸

Analysis of Improving Rehabilitation Policy

Improving rehabilitation was made through parameter adjustment in the year 2008.

Analysis of the Custody Extra Policy

We have built an extra co-flow structure in the model to describe Custody Extra. We treated the policy as if every less serious prisoner was required to serve parole¹⁹. Whilst this is not an exact recreation of part time sentencing it does provide an indication of the effect.

¹⁸ The quick build structure could be further improved by taking into account real life planning issues. How would funding be allocated? Would the change of capacity type really mean that less normal capacity would be built or would quick build capacity be built in addition to the existing planned normal capacity?

¹⁹ This structure can again only give a rough estimate of the impact of the policy. In reality the increases to the probation population would happen during an inmate's sentence. The current solution has been used to explore the idea, with the ultimate plan of upgrading the structure to track offenders simultaneously serving half their time in prison and half on probation.

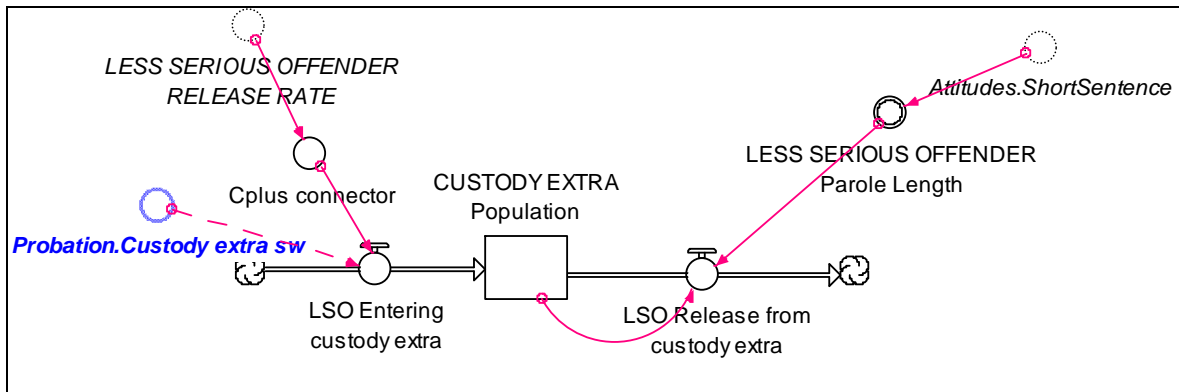

Figure 59: Policy structure: Custody Extra

We have also tied the scheme to electronic tagging. Use of tagging can reduce the strain on probation officers who are able to deal with more offenders. We have simulated this by lowering the normal offender ratio. This should allow the larger number of offenders being supervised under custody extra to be dealt without damaging the worker to offender ratio.

Policy testing

We have tested our policies in two ways: (1) equilibrium to understand how the policies are working, and (2) scenario testing to see how the policies might work in practice. In the equilibrium tests the system was initialized in equilibrium and subjected to a shock input of prisoners as in earlier tests. In 2008 we will introduce each new policy to see how the system is affected. Scenario testing used historical parameter settings and three different projections of population and crime rate developments.

The Quick Build Policy Equilibrium Shock Test

When tested the new policy brings down capacity utilization much more quickly than under normal conditions (Figure 60). The policy however overcompensates leaving the system operating with spare capacity for a number of years (until 2077). Running with extra capacity is in the long term good for the system as it allows growth in population to be absorbed; however there are additional costs involved in maintaining the empty cells. The maintenance cost of over capacity vs under capacity would be a very useful topic for future research.

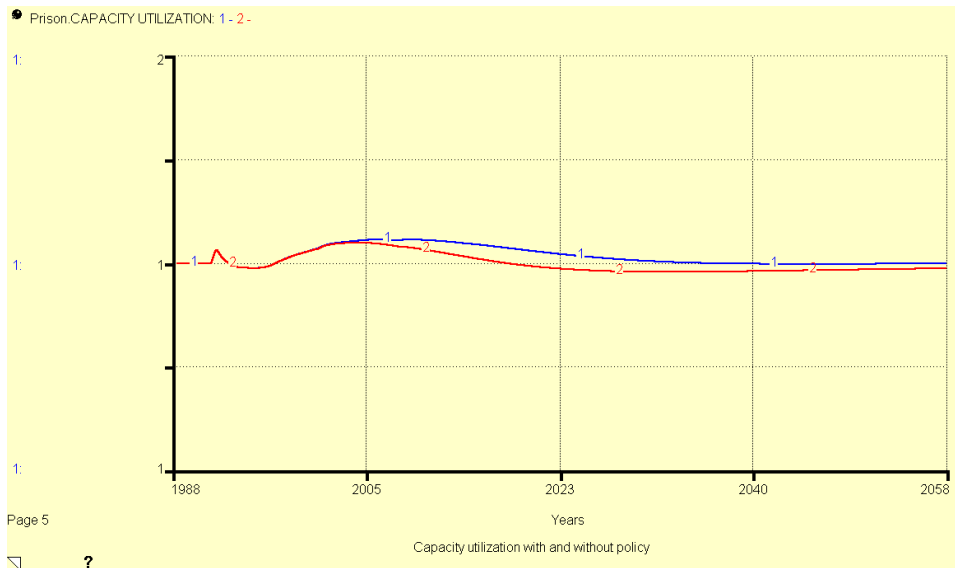

Figure 60: Equilibrium shock test before (1) and after the quick build policy (2)

The extra capacity added also has the side effect of increasing prisoner numbers (Figure 61). Whilst the prisoner number increase does not appear to have an adverse effect on capacity utilization it will have other cost implications for the prison system.

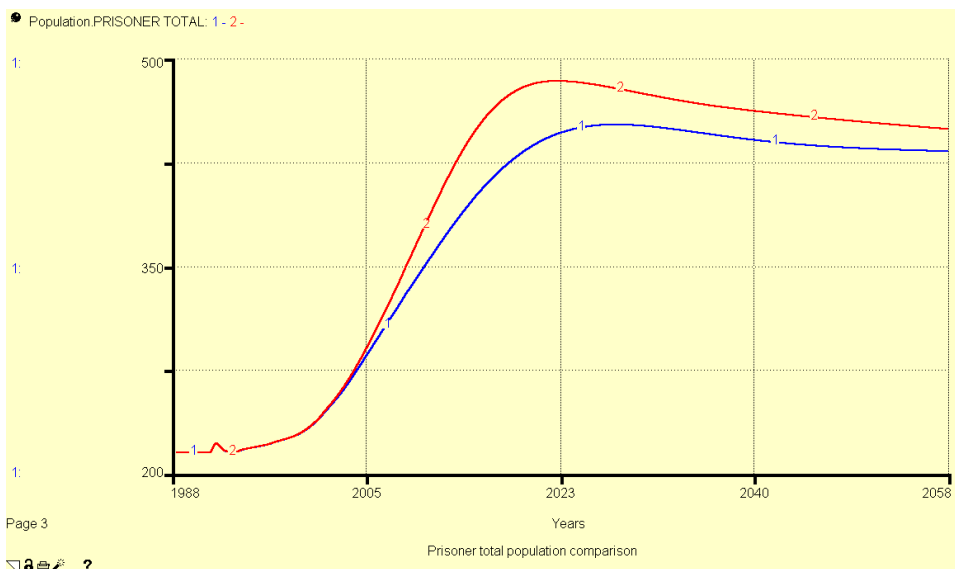

Figure 61: Prisoner population development without (1) and with quick build policy (2)

The prisoner number increase is due to a rise in sentence lengths as the need for early release policies are less necessary. Whilst this does increase the population (more people for longer) it also reduces the rate of recidivism, a major contributor to population growth.

This policy is sensitive to changes in both in the range and the shape of the policy curve. The steeper the initial slope of the curve the more pronounced the behavior it produces.

Improved Rehabilitation Policy Equilibrium Shock Test

Doubling the normal effectiveness of rehabilitation to 0.4 has a significant impact on capacity utilization (Figure 62). However practical questions would need to be asked about how rehabilitation could be improved by this amount.

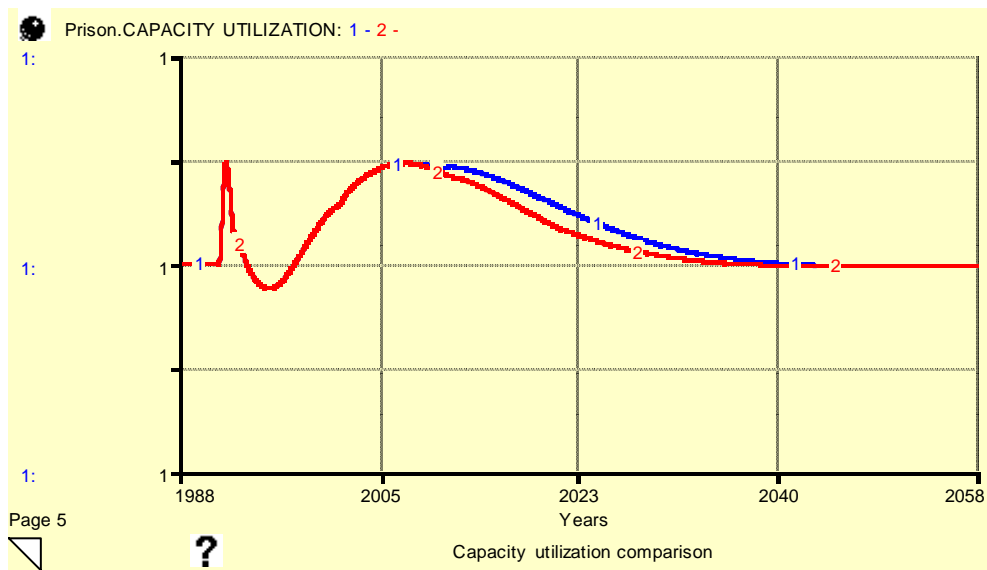

Figure 62: Equilibrium Shock Test: Rehabilitation Effectiveness

Custody Extra Policy Equilibrium Shock Test

Despite the extending time available for rehabilitation and improving probation provision Custody Extra does very little in the equilibrium test (Figure 63). There is a small oscillation at the onset of the policy and a tiny reduction in capacity utilization. We believe this is because short sentence lengths with custody extra are still less than that required for completion of a rehabilitation program.

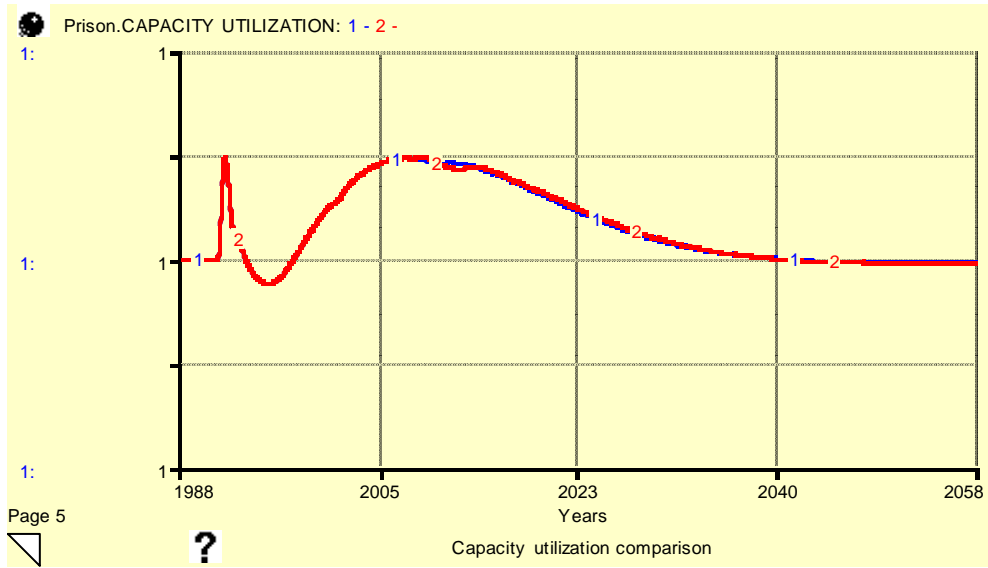

Figure 63: Equilibrium Shock Test: Custody Extra

Scenario Tests

The next set of testing is conducted with historical parameters. As we do not have predicted crime rates or population for the next 18 years we have created three possible futures (Figure 64). The national population has been set to increase along its current trend and in each potential future the crime rate becomes progressively worse. The worsening crime rate will change the population. In Scenario 1 there will be a slow decline in the prison population. Scenario 2 will have a slow growth in the prison population. Scenario 3 will have a growth rate faster than our present condition.

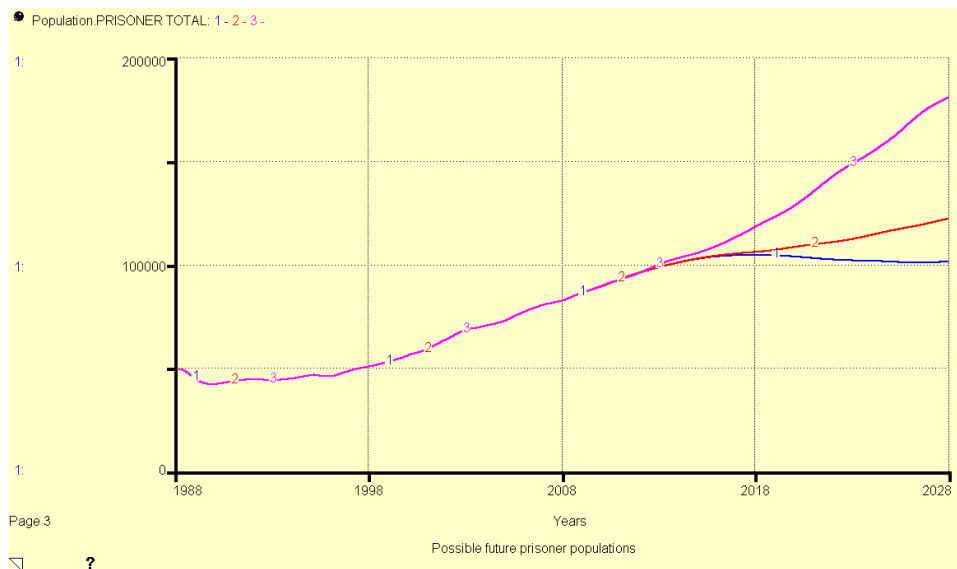

Figure 64: Future prison population scenarios.

Quick Build Policy: Scenario Tests

The quick build policy operated well under both a slow (scenario 2) and a fast (scenario 3) growth rate. In the declining population scenario (scenario 3) the policy successfully brought down capacity utilization, but even a slight decline in the prisoner population the system will result in excess capacity.

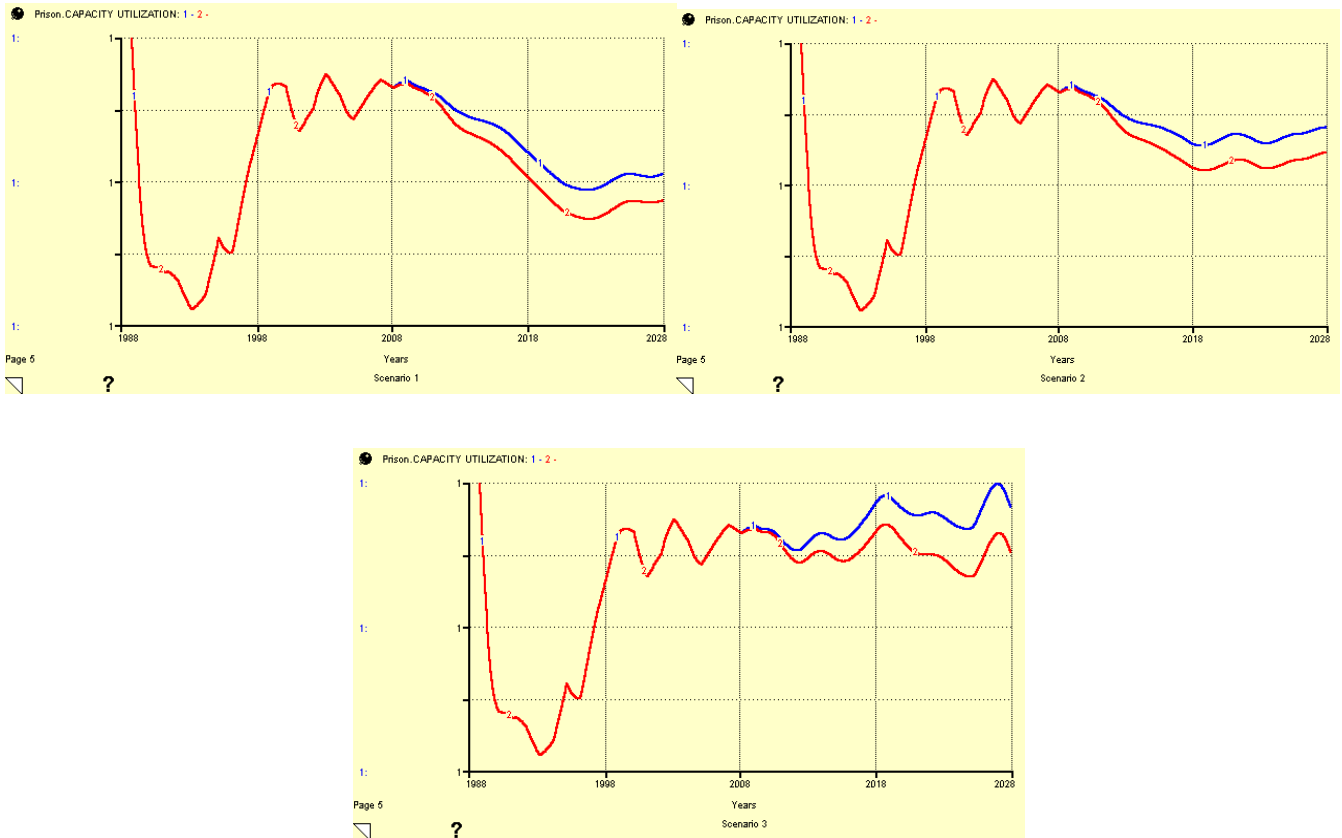

Figure 65: Quick Build policy under 3 different scenarios

Improved Rehabilitation Policy: Scenario tests

The parameter induced rehabilitation policy produces the most dramatic results. Drop in demand from slowing the inflow of recidivists is very effective in reducing population and capacity utilization. It does however lead to excess capacity in the declining population scenario.

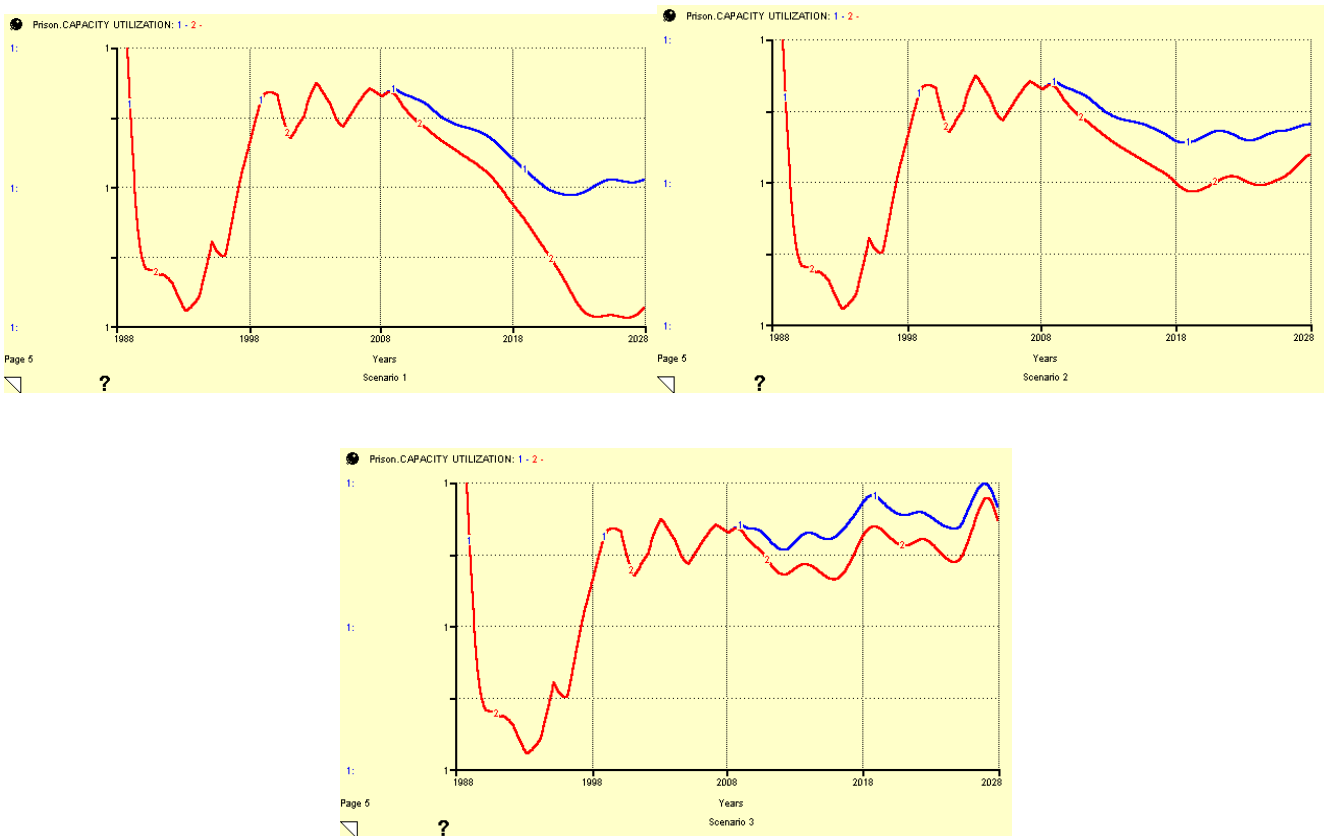

Figure 66: Improved rehabilitation policy under three different scenarios

Custody Extra: Scenario tests

Custody Extra performs well under all three scenarios. Custody Extra needs to be combined with a capacity expanding policy in scenario 3. At least part of the performance weakness seen in scenario 3 is due to the short sentence times spent in prison by offenders in a overcrowded prisons. Even though the sentence time is essentially doubled by the policy it is still not enough to complete a full rehabilitation program.

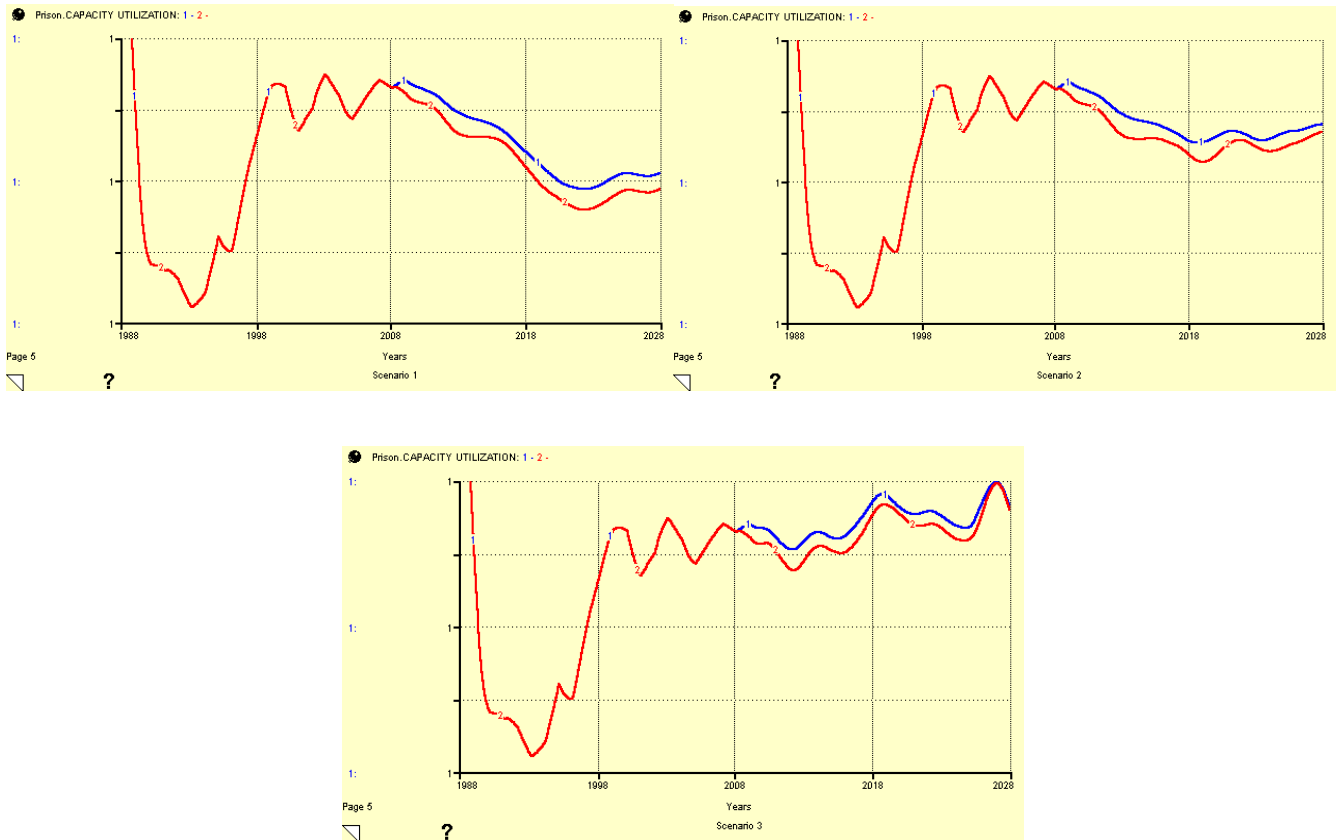

Figure 67: Custody Extra under three different scenarios

Other potential policies

Another set of potential policies exist through altering the adjustment times for the public perceptions of crime, and political punitiveness. The test on this set of policies has been documented in appendix 7 contrary to our hypothesis the effect on capacity utilization behavior proved to be minimal. The testing in this area showed one large problem with trying to control capacity utilization through adjustment times: the affect diminishes after 1998 (Figure 55 and Figure 56), due to the shape of the crime rate curve. Unless there is a longer term reduction to the crime rate, the public perception of the crime rate *should* be high. The only way to bring the perception of the crime rate down would to give the public a much longer adjustment time, or to actually reduce crime for a longer period than has been achieved.

A final potential policy which could be considered is try and influence exactly what the public is measuring when developing punitiveness. The use of publicity regarding local level recidivism reductions in probation based penalties could reduce the public punitiveness. The perception of how well the prison system is performing in terms of recidivism would be an area where the National Offender Management Service has some influence and therefore a better potential candidate for prescribing penal policy.

Conclusions from policy testing

The policies used by NOMS in tackling overcrowding have to be robust under all future scenarios. The prison system must cope with an unpredictable input - that can both rise and fall each year. Under all policies there are problems with excess capacity in scenario 1. In scenario 1 the reduced growth in prison population and the delay in correcting prison capacity (due to the long lifetime of prison capacity) results in excess capacity. All the policies performed well under scenario 2. The quick build and rehabilitation policies showed the better results than Custody Extra in scenario 3.

If the judgment of these strategies is on which can keep the prison system running at as close to optimal capacity without causing excess capacity provision the quick build and custody extra plans both do well. The quick build policy has perhaps the best all around results and would therefore be our recommendation.

If excess capacity is not a problem then the rehabilitation strategy is by far the best performer. Understanding whether excess capacity truly is a problem requires an understanding of what the real costs are of running extra capacity and rehabilitation improvements. Our final recommendation is a additional study to this study: adding a cost effectiveness analysis. Such an analysis would allow us to measure and compare the long term costs of running with different capacity levels. Interesting questions about the relative costs and benefits of each of the policy methods could be more effectively judged.

Conclusion

From our research, the modeling process and the validation of our model we have gained insights into the levers controlling prison overcrowding. From our research we have developed policies designed to address the three most important factors in overcrowding development: the demand for punitiveness, capacity control, and population control through recidivism.

The model provided an insight into how Tim Newburn's (2007) hypothesis could be applied, but the results from our initial policy investigations (appendix 7) indicated that there are still developments to be made in modeling this area. So despite the fact that changing the delay times can affect capacity utilization we have opted not to form policy in this area. Instead we recommend a renewed focus on the area of the generation of punitiveness and its effect on public policy development.

Reducing the building delay was found to have a strong role in controlling capacity utilization. However its effects were not straight forward. In our hypothesis and analysis we demonstrated how the provision of excess capacity could impact on prison sentence lengths – in effect ratcheting up the prison population. Increased attention to rehabilitation provided the best method of reducing the prison population in the long term. This too could cause problems of excess capacity. We felt that the costs of high population vs excess capacity need to be evaluated by conducting a cost effectiveness analysis.

The rehabilitation policy also raised the question of how improvements to rehabilitation can actually be achieved. Our final policy “custody extra” was an attempt to answer questions of how to deliver increased rehabilitation. Custody Extra was aimed to create a system with sentence lengths long enough to deliver more rehabilitation training than at present. As an initial policy it was promising but ultimately in the face of sharp increases in the prison population it could not deliver the results seen in policy based on reducing the building delay.

Our paper has provided some insights into how the different parties involved in the prison system are affected by the events within the system. The policies developed have also shown that there are multiple methods of improving capacity utilization. Ultimately the questions of which policies are best should be evaluated in a future study concentrating on the cost effectiveness of policy, and the nature of the structure of public and political

interactions with the prison system. We feel that this paper provides a valuable basis for the development of work in these two areas.

Appendices

Appendix 1: Equations

This model was designed in ithink using modules. The modules used were: Attitudes, Population, CAPACITY: Prison, CAPACITY: Probation, Recidivism.

Attitudes:

Judicial_Punitiveness(t) = Judicial_Punitiveness(t - dt) + (Change_to_judicial_punitiveness) * dt

INIT Judicial_Punitiveness = .36*(1-Equilibrium_Switch)+.27*Equilibrium_Switch

INFLOWS:

Change_to_judicial_punitiveness = (Effect_of_recidivist_fraction_on_judiciary-
Judicial_Punitiveness)/Time_to_change_judicial_punitiveness

Perception_of_crime_rate(t) = Perception_of_crime_rate(t - dt) + (Change_to_crime__rate_perception) * dt

INIT Perception_of_crime_rate = .065*(1-Equilibrium_Switch)+.05*Equilibrium_Switch

INFLOWS:

Change_to_crime__rate_perception = (CRIMES_PER_PERSON-
Perception_of_crime_rate)/time_to_percieve_changes_in_crime

PERCIEVED_RECIDIVIST_FRACTION(t) = PERCIEVED_RECIDIVIST_FRACTION(t - dt) +
(change_to_recidivist_perception) * dt

INIT PERCIEVED_RECIDIVIST_FRACTION = .6*(1-Equilibrium_Switch)+.5*Equilibrium_Switch

INFLOWS:

change_to_recidivist_perception = (Punishment_System__recidivism_fraction-
PERCIEVED_RECIDIVIST_FRACTION)/time_to_change_recidivist_perception

Political_Punitiveness(t) = Political_Punitiveness(t - dt) + (Change_to_political_punitiveness) * dt

INIT Political_Punitiveness = Public_Punitiveness

INFLOWS:

Change_to_political_punitiveness = (Public_Punitiveness-
Political_Punitiveness)/time_to_change_political_punitiveness

Public_Punitiveness(t) = Public_Punitiveness(t - dt) + (Change_to_public_punitiveness) * dt

INIT Public_Punitiveness = Perception_of_crime_rate

INFLOWS:

Change_to_public_punitiveness = (Perception_of_crime_rate-
Public_Punitiveness)/Time_to_change_public_punitiveness

Adjusted_Extra_Statutory_Sentence =

Recidivism.CAPACITY_UTILIZATION_EFFECT_ON_SENTENCE*Avge_Extra_Sentence

Adjusted_Statutory_Short_Sentence =

Recidivism.CAPACITY_UTILIZATION_EFFECT_ON_SENTENCE*Average_Short_Sentence

Average_Short_Sentence =

MAX(0.1,Effect_of_political_punitiveness_on_sentencing*Normal_Statutory_Short_Sentence)

Avge_Extra_Sentence =

MAX(0.1,Effect_of_political_punitiveness_on_sentencing*Normal_Statutory_Extra_Sentence)

CRIMES_PER_PERSON = the_future*(1-

Equilibrium_Switch)+Equilibrium_Crimes_Per_Person*Equilibrium_Switch

Crime_perception_time = 3

Equilibrium_switch = .Equilibrium_master_switch

Equilibrium_Crimes_Per_Person = .05

ExtraSentence = Adjusted_Extra_Statutory_Sentence*effect_of_recidivist_fraction_on_sentence

IMPRISONMENT_FRACTION = Judicial_Punitiveness

LongSentence = ExtraSentence+ShortSentence

Normal_perception_of_crime_rate = .05

Normal_political_punitiveness = .05

Normal_recidivist_fraction = .5

Normal_Statutory_Extra_Sentence = 1.2*(1-Equilibrium_Switch)+.55*Equilibrium_Switch

Normal_Statutory_Short_Sentence = .35*(1-Equilibrium_Switch)+.25*Equilibrium_Switch

offence_seriousness = effect_of_recid_on_Offence_Seriousness

Publicity_change = 5

Publicity_Policy = 0

Punishment_System__recidivism_fraction =

(Population.prison_recidivism_rate*Weight_attached_to_prison_recidivism+Population.Probation_recid_rat

```

e)/(Population.First_Time_Offender_entry_rate+Population.Probation_recid_rate+(Population.prison_recidivism_rate*Weight_attached_to_prison_recidivism))
scenario = 1
ShortSentence = Adjusted_Statutory_Short_Sentence*effect_of_recidivist_fraction_on_sentence
the_future =
IF(scenario=1)THEN(nice_future_CRIMES_PER_PERSON_1)ELSE(IF(scenario=2)THEN(OK_future_CRIMES_PER_PERSON_2)ELSE(horrible_future_CRIMES_PER_PERSON_3))
Time_to_change_judicial_punitiveness = 2
time_to_change_political_punitiveness = 2
Time_to_change_public_punitiveness = 2
time_to_change_recidivist_perception = 3
time_to_perceive_changes_in_crime =
If(Publicity_Policy=1)then(If(time>2007.5)then(Publicity_change)else(Crime_perception_time))else(Crime_perception_time)
Weight_attached_to_prison_recidivism = 1
Effect_of_political_punitiveness_on_sentencing =
GRAPH(Political_Punitiveness/Normal_political_punitiveness)
(0.00, 0.39), (0.5, 0.39), (1.00, 1.00), (1.50, 1.24), (2.00, 1.44), (2.50, 1.61), (3.00, 1.70), (3.50, 1.76), (4.00, 1.76)
Effect_of_recidivist_fraction_on_judiciary =
GRAPH(PERCIEVED_RECIDIVIST_FRACTION/Normal_recidivist_fraction)
(0.7, 0.18), (0.8, 0.195), (0.9, 0.223), (1, 0.27), (1.10, 0.365), (1.20, 0.392), (1.30, 0.4), (1.40, 0.4), (1.50, 0.4), (1.60, 0.4), (1.70, 0.4), (1.80, 0.4), (1.90, 0.4), (2.00, 0.4)
effect_of_recidivist_fraction_on_sentence =
GRAPH(PERCIEVED_RECIDIVIST_FRACTION/Normal_recidivist_fraction)
(0.6, 0.88), (0.7, 0.88), (0.8, 0.88), (0.9, 0.92), (1, 1.00), (1.10, 1.12), (1.20, 1.30), (1.30, 1.57), (1.40, 1.74), (1.50, 1.86), (1.60, 1.91), (1.70, 1.94), (1.80, 1.94), (1.90, 1.96), (2.00, 1.96)
effect_of_recid_on_Offence_Seriousness =
GRAPH(PERCIEVED_RECIDIVIST_FRACTION/Normal_recidivist_fraction)
(0.7, 0.18), (0.8, 0.195), (0.9, 0.223), (1, 0.27), (1.10, 0.365), (1.20, 0.413), (1.30, 0.435), (1.40, 0.448), (1.50, 0.463), (1.60, 0.463), (1.70, 0.465), (1.80, 0.468), (1.90, 0.468), (2.00, 0.468)
horrible_future_CRIMES_PER_PERSON_3 = GRAPH(time)
(1988, 0.078), (1989, 0.074), (1990, 0.077), (1991, 0.09), (1992, 0.104), (1993, 0.109), (1994, 0.108), (1995, 0.102), (1996, 0.099), (1997, 0.097), (1998, 0.088), (1999, 0.087), (2000, 0.098), (2001, 0.101), (2002, 0.098), (2003, 0.104), (2004, 0.113), (2005, 0.113), (2006, 0.105), (2007, 0.103), (2008, 0.1), (2009, 0.091), (2010, 0.122), (2011, 0.12), (2012, 0.11), (2013, 0.129), (2014, 0.148), (2015, 0.155), (2016, 0.146), (2017, 0.122), (2018, 0.124), (2019, 0.129), (2020, 0.142), (2021, 0.152), (2022, 0.178), (2023, 0.193), (2024, 0.191), (2025, 0.136), (2026, 0.13), (2027, 0.173), (2028, 0.178)
nice_future_CRIMES_PER_PERSON_1 = GRAPH(time)
(1988, 0.078), (1989, 0.074), (1990, 0.077), (1991, 0.09), (1992, 0.104), (1993, 0.109), (1994, 0.108), (1995, 0.102), (1996, 0.099), (1997, 0.097), (1998, 0.088), (1999, 0.087), (2000, 0.098), (2001, 0.101), (2002, 0.098), (2003, 0.104), (2004, 0.113), (2005, 0.113), (2006, 0.105), (2007, 0.103), (2008, 0.1), (2009, 0.091), (2010, 0.088), (2011, 0.095), (2012, 0.092), (2013, 0.0885), (2014, 0.08), (2015, 0.0755), (2016, 0.076), (2017, 0.077), (2018, 0.0835), (2019, 0.0895), (2020, 0.095), (2021, 0.095), (2022, 0.0915), (2023, 0.0875), (2024, 0.087), (2025, 0.092), (2026, 0.0885), (2027, 0.0815), (2028, 0.0855)
OK_future_CRIMES_PER_PERSON_2 = GRAPH(time)
(1988, 0.078), (1989, 0.074), (1990, 0.077), (1991, 0.09), (1992, 0.104), (1993, 0.109), (1994, 0.108), (1995, 0.102), (1996, 0.099), (1997, 0.097), (1998, 0.088), (1999, 0.087), (2000, 0.098), (2001, 0.101), (2002, 0.098), (2003, 0.104), (2004, 0.113), (2005, 0.113), (2006, 0.105), (2007, 0.103), (2008, 0.1), (2009, 0.091), (2010, 0.088), (2011, 0.095), (2012, 0.095), (2013, 0.093), (2014, 0.0895), (2015, 0.089), (2016, 0.096), (2017, 0.111), (2018, 0.111), (2019, 0.103), (2020, 0.0965), (2021, 0.0975), (2022, 0.106), (2023, 0.111), (2024, 0.113), (2025, 0.115), (2026, 0.107), (2027, 0.106), (2028, 0.109)
Prisoner_perception_of_the_benefits_of_crime =
GRAPH((Perception_of_crime_rate/Normal_perception_of_crime_rate))
(0.00, 0.00), (0.25, 0.075), (0.5, 0.205), (0.75, 0.41), (1.00, 0.56), (1.25, 0.68), (1.50, 0.735), (1.75, 0.775), (2.00, 0.79), (2.25, 0.81), (2.50, 0.82), (2.75, 0.82), (3.00, 0.82)
Probatee_perception_of_the_benefits_of_crime =
GRAPH((Perception_of_crime_rate/Normal_perception_of_crime_rate))
(0.00, 0.485), (0.25, 0.485), (0.5, 0.49), (0.75, 0.5), (1.00, 0.5), (1.25, 0.505), (1.50, 0.535), (1.75, 0.585), (2.00, 0.62), (2.25, 0.65), (2.50, 0.67), (2.75, 0.69), (3.00, 0.69)
Reference_CRIMES_PER_PERSON = GRAPH(time)

```

(1988, 0.078), (1989, 0.074), (1990, 0.077), (1991, 0.09), (1992, 0.104), (1993, 0.109), (1994, 0.108), (1995, 0.102), (1996, 0.099), (1997, 0.097), (1998, 0.088), (1999, 0.087), (2000, 0.098), (2001, 0.101), (2002, 0.098), (2003, 0.104), (2004, 0.113), (2005, 0.113), (2006, 0.105), (2007, 0.103), (2008, 0.1), (2009, 0.091)

CAPACITY:

Equilibrium_switch = .Equilibrium_master_switch

CAPACITY.Prison:

Prison_Cells(t) = Prison_Cells(t - dt) + (construction_rate - depreciation_rate) * dt

INIT Prison_Cells = Population.PRISONER_TOTAL*Initial_capacity_gap/desired_capacity_utilization*(1-CAPACITY.Equilibrium_switch)+Population.PRISONER_TOTAL/desired_capacity_utilization*CAPACITY.Equilibrium_switch

INFLOWS:

construction_rate =

IF(Quick_build_policy=0)THEN(Prison_Cells_Under_Construction/construction_time)ELSE(Prison_Cells_Under_Construction*(1-Effect_of_cap_util_on_construction)/construction_time)

OUTFLOWS:

depreciation_rate = Prison_Cells/average_life_of_cell

Prison_Cells_Under_Construction(t) = Prison_Cells_Under_Construction(t - dt) + (order_rate - construction_rate - Quick_build_units_construction_rate) * dt

INIT Prison_Cells_Under_Construction = depreciation_rate*construction_time

INFLOWS:

order_rate = indicated_orders*pct_of_gap_funded

OUTFLOWS:

construction_rate =

IF(Quick_build_policy=0)THEN(Prison_Cells_Under_Construction/construction_time)ELSE(Prison_Cells_Under_Construction*(1-Effect_of_cap_util_on_construction)/construction_time)

Quick_build_units_construction_rate =

Prison_Cells_Under_Construction*Effect_of_cap_util_on_construction/Quick_build_construction_time

quick_build_cells(t) = quick_build_cells(t - dt) + (Quick_build_units_construction_rate -

Quick_Build_Depreciation_rate) * dt

INIT quick_build_cells = 0

INFLOWS:

Quick_build_units_construction_rate =

Prison_Cells_Under_Construction*Effect_of_cap_util_on_construction/Quick_build_construction_time

OUTFLOWS:

Quick_Build_Depreciation_rate = quick_build_cells/Quick_Build_Capacity_Lifetime

reported_capacity_utilization(t) = reported_capacity_utilization(t - dt) +

(change_to_reported_capacity_utilization) * dt

INIT reported_capacity_utilization = 1

INFLOWS:

change_to_reported_capacity_utilization = (CAPACITY_UTILIZATION - reported_capacity_utilization)/time_to_change

Adjst_decision = If(cell_gap_adj_connector>1.03)then(4)else(5)

adjustment_for_cells_under_construction = (desired_prison_cells_under_construction - Prison_Cells_Under_Construction)/construction_gap_adjustment_time

average_life_of_cell = 60

Capacity_connector = IF(time>2007.5)then(Quick_build_policy*reported_capacity_utilization)else(0)

CAPACITY_UTILIZATION = Population.PRISONER_TOTAL/PRISON_CAPACITY

cells_gap_adj_time = if(State_of_emergency=0)then(5)else(Adjst_decision)

cell_gap_adj_connector = IF(time>2007.5)then(State_of_emergency*reported_capacity_utilization)else(0)

construction_gap_adjustment_time = 5

construction_time = 5

construction_time_weighted_average = construction_time*(1-

Effect_of_cap_util_on_construction)+Quick_build_construction_time*Effect_of_cap_util_on_construction

desired_capacity_utilization = 1.00

Desired_Cell_order_rate = desired_replacement_rate+prison_cells_stock_adj_rate

desired_prison_cells_5_year_forecast = prison_population_5_year_forecast*desired_capacity_utilization

desired_prison_cells_under_construction = Desired_Cell_order_rate*construction_time_weighted_average

desired_replacement_rate = expected_depreciation_rate

expectation_adjustment_time = 5

```

expected_depreciation_rate = smth1(depreciation_rate,expectation_adjustment_time)
indicated_orders = MAX(0,adjustment_for_cells_under_construction+Desired_Cell_order_rate)
Initial_capacity_gap = .86
Normal_capacity_utilization = 1
pct_of_gap_funded = (0.85+sinwave(.15,10))*(1-
CAPACITY.Equilibrium_switch)+1*CAPACITY.Equilibrium_switch
perceived_cell_growth_percentage = 100*smth1(trend(Prison_Cells,1/3),1)
perceived_pop_growth_percentage =
100*smth1(trend(Population.PRISONER_TOTAL,1/3,population_growth_percentage/100),1)
population_growth_percentage = 0
prisoner_capacity_per_cell = 1
PRISON_CAPACITY = (Prison_Cells+quick_build_cells)*prisoner_capacity_per_cell
prison_cells_5_year_forecast = Prison_Cells*(1+perceived_cell_growth_percentage/100)^5
prison_cells_stock_adj_rate = delay(prison_cell_5_year_forecast_adjustment,1)
prison_cell_5_year_forecast_adjustment = (prison_cell_gap_5_year_forecast/(cells_gap_adj_time/3))
prison_cell_gap_5_year_forecast = (desired_prison_cells_5_year_forecast-prison_cells_5_year_forecast)
prison_population_5_year_forecast =
Population.PRISONER_TOTAL*(1+perceived_pop_growth_percentage/100)^5
Quick_Build_Capacity_Lifetime = 30
Quick_build_construction_time = 2
Quick_build_policy = 0
State_of_emergency = 0
time_to_change = 1
actual_Prison_Capacity = GRAPH(time)
(1988, 41994), (1989, 44179), (1990, 45427), (1991, 42804), (1992, 43875), (1993, 46239), (1994, 46646),
(1995, 48291), (1996, 50239), (1997, 53152), (1998, 56329), (1999, 61253), (2000, 62369), (2001, 63346),
(2002, 63530), (2003, 64046), (2004, 66104), (2005, 67505), (2006, 69394), (2007, 70686), (2008, 71374),
(2009, 73452)
Effect_of_cap_util_on_construction = GRAPH(Capacity_connector/Normal_capacity_utilization)
(0.9, 0.00), (0.933, 0.00), (0.967, 0.00), (1.00, 0.00), (1.03, 0.018), (1.07, 0.037), (1.10, 0.057), (1.13, 0.08),
(1.17, 0.1), (1.20, 0.1)

CAPACITY.Probation:
Probation_staff(t) = Probation_staff(t - dt) + (Training_Rate - Quit_Rate) * dt
INIT Probation_staff = Population.PROBATEE_TOTAL*desired_worker_to_offender_ratio
INFLOWS:
Training_Rate = Trainees/training_time
OUTFLOWS:
Quit_Rate = Probation_staff/Average_Service_Length
Trainees(t) = Trainees(t - dt) + (Hiring_Rate - Training_Rate) * dt
INIT Trainees = Quit_Rate*training_time
INFLOWS:
Hiring_Rate = desired_hiring*pct_of_gap_funded
OUTFLOWS:
Training_Rate = Trainees/training_time
Actual_worker_to_offender_ratio = Probation_staff/Population.PROBATEE_TOTAL
adjustment_for_trainees = (desired_training-Trainees)/trainee_adj_time
Average_Service_Length = delay1(Normal_Service*Effect_of_Caseload_on_Average_Service_Length,2)
Custody_Extra = 0
desired_hiring = MAX(0,adjustment_for_trainees+desired_hiring_rate)/Hiring_time
desired_hiring_rate = desired_replacement_rate+desired_prison_cells_stock_adj_rate
desired_prison_cells_stock_adj_rate = (workforce_gap_5_year_forecast/(workforce_gap_adj_time/3))
desired_replacement_rate = expected_quit_rate
desired_training = desired_hiring_rate*training_time
desired_worker_to_offender_ratio = .025
desired_workforce_5_year_forecast =
probation_population_5_year_forecast*desired_worker_to_offender_ratio
expectation_adt_time = 4
expected_quit_rate = smth1(Quit_Rate,expectation_adt_time)
Hiring_time = 1
Normal_ratio = if(CAPACITY.Equilibrium_switch=0)then(policy_connector)else(.025)

```

```

Normal_Service = 10
pct_of_gap_funded = (0.85+sinwave(.15,10))*(1-
CAPACITY.Equilibrium_switch)+1*CAPACITY.Equilibrium_switch
perceived_pop_growth_percentage =
100*smth1(trend(Population.PROBATEE_TOTAL,1/3,population_growth_percentage/100),1)
perceived_workforce_growth_percentage = 100*smth1(trend(Probation_staff,1/3),5)
policy_connector = .025*(1-
Custody_Extra)+(If(time<2007.5)then(.025*Custody_Extra)else(.02*Custody_Extra))
population_growth_percentage = 4*(1-
CAPACITY.Equilibrium_switch)+0*CAPACITY.Equilibrium_switch
probation_population_5_year_forecast =
Population.PROBATEE_TOTAL*(1+perceived_pop_growth_percentage/100)^5
trainee_adj_time = 2
training_time = 2
workforce_5_year_forecast = Probation_staff*(1+perceived_workforce_growth_percentage/100)^5
workforce_gap_5_year_forecast = (desired_workforce_5_year_forecast-workforce_5_year_forecast)
workforce_gap_adj_time = 4
Effect_of_Caseload_on_Average_Service_Length =
GRAPH(Actual_worker_to_offender_ratio/Normal_ratio)
(0.00, 1.06), (0.333, 1.06), (0.667, 1.03), (1.00, 1.00), (1.33, 0.956), (1.67, 0.902), (2.00, 0.77), (2.33, 0.62),
(2.67, 0.542), (3.00, 0.495), (3.33, 0.47), (3.67, 0.45), (4.00, 0.45)

Population:
Awaiting_Trial_and_Sentence(t) = Awaiting_Trial_and_Sentence(t - dt) + (First_Time_Offender_entry_rate
+ prison_recidivism_rate + Probation_recid_rate - Probation_entry_rate - Prison_Entry_rate) * dt
INIT Awaiting_Trial_and_Sentence = 42000*(1-Equilibrium_Switch)+2000*Equilibrium_Switch
INFLOWS:
First_Time_Offender_entry_rate =
crimes_resulting_in_sentence*fraction_of_crimes_committed_by_first_offenders+FO_SHOCK
prison_recidivism_rate =
(RELEASED_OFFENDERS*Recidivism.PRISON_FRACTIONAL_RECIDIVISM)/recidivism_detection_time
Probation_recid_rate =
Released_Probatees*Recidivism.Probation_Recidivism_Fraction/recidivism_detection_time
OUTFLOWS:
Probation_entry_rate = Awaiting_Trial_and_Sentence*(1-
Attitudes.IMPRISONMENT_FRACTION)/Processing_Time
Prison_Entry_rate =
(Awaiting_Trial_and_Sentence*Attitudes.IMPRISONMENT_FRACTION)/Processing_Time
CUSTODY_Extra_Population(t) = CUSTODY_Extra_Population(t - dt) + (LSO_Entering_custody_extra -
LSO_Release_from_custody_extra) * dt
INIT CUSTODY_Extra_Population =
LSO_Entering_custody_extra*LESS_SERIOUS_OFFENDER_Parole_Length
INFLOWS:
LSO_Entering_custody_extra = If(Probation.Custody_Extra=0)then(0)else(Cplus_connector)
OUTFLOWS:
LSO_Release_from_custody_extra =
CUSTODY_Extra_Population/LESS_SERIOUS_OFFENDER_Parole_Length
ON_PROBATION(t) = ON_PROBATION(t - dt) + (Probation_entry_rate - Probation_Exit_Rate) * dt
INIT ON_PROBATION = Probation_entry_rate*Probation_length
INFLOWS:
Probation_entry_rate = Awaiting_Trial_and_Sentence*(1-
Attitudes.IMPRISONMENT_FRACTION)/Processing_Time
OUTFLOWS:
Probation_Exit_Rate = ON_PROBATION/Probation_length
PAROLE_POPULATION(t) = PAROLE_POPULATION(t - dt) + (Entering_parole_rate -
Parole_Release_Rate) * dt
INIT PAROLE_POPULATION = Entering_parole_rate*Parole_Length
INFLOWS:
Entering_parole_rate = SERIOUS_OFFENDER_RELEASE_RATE
OUTFLOWS:

```

$Parole_Release_Rate = PAROLE_POPULATION/Parole_Length$
 $PRISON_POPULATION(t) = PRISON_POPULATION(t - dt) + (Prison_Entry_rate - LESS_SERIOUS_OFFENDER_RELEASE_RATE - short_sentence_completion_rate) * dt$
 $INIT PRISON_POPULATION = Prison_Entry_rate*Attitudes.ShortSentence$
INFLOWS:
 $Prison_Entry_rate = (Awaiting_Trial_and_Sentence*Attitudes.IMPRISONMENT_FRACTION)/Processing_Time$
OUTFLOWS:
 $LESS_SERIOUS_OFFENDER_RELEASE_RATE = PRISON_POPULATION*(1 - Attitudes.offence_seriousness)/Attitudes.ShortSentence$
 $short_sentence_completion_rate = PRISON_POPULATION*Attitudes.offence_seriousness/Attitudes.ShortSentence$
 $Reformed_prisoners(t) = Reformed_prisoners(t - dt) + (Prisoner_Reform_rate - Offender_Death_Rate) * dt$
 $INIT Reformed_prisoners = Prisoner_Reform_rate*Average_Lifespan$
INFLOWS:
 $Prisoner_Reform_rate = (RELEASED_OFFENDERS*(1 - Recidivism.PRISON_FRACTIONAL_RECIDIVISM))/recidivism_detection_time$
OUTFLOWS:
 $Offender_Death_Rate = Reformed_prisoners/Average_Lifespan$
 $Reformed_Probatees(t) = Reformed_Probatees(t - dt) + (Probatee_Reform_rate - Death_rate) * dt$
 $INIT Reformed_Probatees = Probatee_Reform_rate*Average_Lifespan$
INFLOWS:
 $Probatee_Reform_rate = Released_Probatees*(1 - Recidivism.Probation_Recidivism_Fraction)/recidivism_detection_time$
OUTFLOWS:
 $Death_rate = Reformed_Probatees/Average_Lifespan$
 $RELEASED_OFFENDERS(t) = RELEASED_OFFENDERS(t - dt) + (LESS_SERIOUS_OFFENDER_RELEASE_RATE + SERIOUS_OFFENDER_RELEASE_RATE - Prisoner_Reform_rate - prison_recidivism_rate) * dt$
 $INIT RELEASED_OFFENDERS = (LESS_SERIOUS_OFFENDER_RELEASE_RATE + SERIOUS_OFFENDER_RELEASE_RATE)*recidivism_detection_time$
INFLOWS:
 $LESS_SERIOUS_OFFENDER_RELEASE_RATE = PRISON_POPULATION*(1 - Attitudes.offence_seriousness)/Attitudes.ShortSentence$
 $SERIOUS_OFFENDER_RELEASE_RATE = SERIOUS_OFFENDERS/Attitudes.ExtraSentence$
OUTFLOWS:
 $Prisoner_Reform_rate = (RELEASED_OFFENDERS*(1 - Recidivism.PRISON_FRACTIONAL_RECIDIVISM))/recidivism_detection_time$
 $prison_recidivism_rate = (RELEASED_OFFENDERS*Recidivism.PRISON_FRACTIONAL_RECIDIVISM)/recidivism_detection_time$
 $Released_Probatees(t) = Released_Probatees(t - dt) + (Probation_Exit_Rate - Probatee_Reform_rate - Probation_recid_rate) * dt$
 $INIT Released_Probatees = Probation_Exit_Rate*recidivism_detection_time$
INFLOWS:
 $Probation_Exit_Rate = ON_PROBATION/Probation_length$
OUTFLOWS:
 $Probatee_Reform_rate = Released_Probatees*(1 - Recidivism.Probation_Recidivism_Fraction)/recidivism_detection_time$
 $Probation_recid_rate = Released_Probatees*Recidivism.Probation_Recidivism_Fraction/recidivism_detection_time$
 $SERIOUS_OFFENDERS(t) = SERIOUS_OFFENDERS(t - dt) + (short_sentence_completion_rate - SERIOUS_OFFENDER_RELEASE_RATE) * dt$
 $INIT SERIOUS_OFFENDERS = short_sentence_completion_rate*Attitudes.ExtraSentence$
INFLOWS:
 $short_sentence_completion_rate = PRISON_POPULATION*Attitudes.offence_seriousness/Attitudes.ShortSentence$
OUTFLOWS:
 $SERIOUS_OFFENDER_RELEASE_RATE = SERIOUS_OFFENDERS/Attitudes.ExtraSentence$
 $Average_Lifespan = 55$

```

Cplus_connector = If(time>2007.5)then(LESS_SERIOUS_OFFENDER_RELEASE_RATE)else(0)
crimes_resulting_in_sentence =
fraction_of_crimes_reported_captured_and_proceeded_against*Total_crimes
English_population = The_once_and_future_English_population*(1-
Equilibrium_Switch)+Equilibrium_population*Equilibrium_Switch
Equilibrium_population = 20000
Equilibrium_switch = .Equilibrium_master_switch
extra_pop = Untried_Prisoners + Non_Criminal_Prisoners + Convicted_Unsentenced_Prisoners
FO_SHOCK = (step(1000,1990.5))*FIRST_OFFENDER_Shock
fraction_of_crimes_committed_by_first_offenders = .10*(1-Equilibrium_switch)+1*Equilibrium_switch
fraction_of_crimes_reported_captured_and_proceeded_against = .11*(1-
Equilibrium_Switch)+1*Equilibrium_Switch
LESS_SERIOUS_OFFENDER_Parole_Length = Attitudes.ShortSentence
Parole_Length = Portion_of_sentence_on_parole*(Attitudes.LongSentence)
Portion_of_sentence_on_parole = .2
PRISONER_TOTAL = PRISON_POPULATION+SERIOUS_OFFENDERS+extra_pop*(1-
Equilibrium_switch)
PROBATEE_TOTAL = ON_PROBATION+PAROLE_POPULATION+CUSTODY_Extra_Population
Probation_length = 1
Processing_Time = .5*(1-Equilibrium_Switch)+1*Equilibrium_Switch
recidivism_detection_time = 2
REFERENCE_TOTAL_PRISON_POP =
actual_sentenced_Prisoner_Population+Convicted_Unsentenced_Prisoners+Non_Criminal_Prisoners+Untried_Prisoners
Total_crimes = English_population*Attitudes.CRIMES_PER_PERSON
actual_probation_pop = GRAPH(time)
(1988, 75000), (1989, 79000), (1990, 87000), (1991, 90000), (1992, 90000), (1993, 89000), (1994, 97000),
(1995, 97000), (1996, 97000), (1997, 100000), (1998, 105000), (1999, 115000), (2000, 110000), (2001,
109000), (2002, 109000), (2003, 116000), (2004, 121000), (2005, 128000), (2006, 137000), (2007, 147000),
(2008, 150000), (2009, 147000)
actual_sentenced_Prisoner_Population = GRAPH(time)
(1988, 38000), (1989, 38000), (1990, 38000), (1991, 36000), (1992, 35000), (1993, 35000), (1994, 33000),
(1995, 36000), (1996, 39000), (1997, 43000), (1998, 49000), (1999, 52000), (2000, 51000), (2001, 53000),
(2002, 54000), (2003, 57000), (2004, 59000), (2005, 61000), (2006, 62000), (2007, 63000), (2008, 66000),
(2009, 68000)
Convicted_Unsentenced_Prisoners = GRAPH(time)
(1988, 1551), (1989, 1664), (1990, 1819), (1991, 1833), (1992, 1942), (1993, 2013), (1994, 2714), (1995,
3188), (1996, 3069), (1997, 3161), (1998, 3189), (1999, 4116), (2000, 4899), (2001, 4214), (2002, 4261),
(2003, 5204), (2004, 5177), (2005, 4779), (2006, 4780), (2007, 5003), (2008, 4457), (2009, 4690)
Historic_English_population = GRAPH(time)
(1988, 5.7e+007), (1989, 5.7e+007), (1990, 5.7e+007), (1991, 5.7e+007), (1992, 5.7e+007), (1993,
5.8e+007), (1994, 5.8e+007), (1995, 5.8e+007), (1996, 5.8e+007), (1997, 5.8e+007), (1998, 5.8e+007),
(1999, 5.8e+007), (2000, 5.9e+007), (2001, 5.9e+007), (2002, 5.9e+007), (2003, 5.9e+007), (2004, 6e+007),
(2005, 6e+007), (2006, 6e+007), (2007, 6.1e+007), (2008, 6.1e+007)
Non_Criminal_Prisoners = GRAPH(time)
(1988, 270), (1989, 227), (1990, 220), (1991, 201), (1992, 300), (1993, 308), (1994, 574), (1995, 640),
(1996, 649), (1997, 633), (1998, 557), (1999, 555), (2000, 548), (2001, 581), (2002, 1129), (2003, 831),
(2004, 1145), (2005, 1017), (2006, 1069), (2007, 1422), (2008, 1289), (2009, 1520)
reference_frac_recid_rate = GRAPH(time)
(1988, 0.55), (1989, 0.54), (1990, 0.52), (1991, 0.53), (1992, 0.52), (1993, 0.54), (1994, 0.57), (1995, 0.58),
(1996, 0.57), (1997, 0.58), (1998, 0.6), (1999, 0.6), (2000, 0.65), (2001, 0.61), (2002, 0.67), (2003, 0.66),
(2004, 0.65)
reference_imprisonment_fraction = GRAPH(time)
(1988, 0.55), (1988, 0.53), (1989, 0.5), (1990, 0.45), (1991, 0.46), (1992, 0.45), (1993, 0.43), (1994, 0.43),
(1995, 0.45), (1996, 0.42), (1997, 0.43), (1998, 0.42), (1999, 0.43), (2000, 0.44), (2001, 0.43), (2002, 0.43),
(2003, 0.42), (2004, 0.42), (2005, 0.4), (2006, 0.37), (2007, 0.37), (2008, 0.36)
The_once_and_future_English_population = GRAPH(time)
(1988, 5.7e+007), (1989, 5.7e+007), (1990, 5.7e+007), (1991, 5.7e+007), (1992, 5.7e+007), (1993,
5.8e+007), (1994, 5.8e+007), (1995, 5.8e+007), (1996, 5.8e+007), (1997, 5.8e+007), (1998, 5.8e+007),
(1999, 5.9e+007), (2000, 5.9e+007), (2001, 5.9e+007), (2002, 5.9e+007), (2003, 5.9e+007), (2004, 6e+007),
(2005, 6e+007), (2006, 6e+007), (2007, 6.1e+007), (2008, 6.1e+007), (2009, 6.1e+007), (2010, 6.2e+007),

```

(2011, 6.2e+007), (2012, 6.3e+007), (2013, 6.3e+007), (2014, 6.3e+007), (2015, 6.4e+007), (2016, 6.4e+007), (2017, 6.4e+007), (2018, 6.4e+007), (2019, 6.4e+007), (2020, 6.5e+007), (2021, 6.5e+007), (2022, 6.5e+007), (2023, 6.5e+007), (2024, 6.5e+007), (2025, 6.6e+007), (2026, 6.6e+007), (2027, 6.7e+007), (2028, 6.7e+007)

Untried_Prisoners = GRAPH(time)
(1988, 9611), (1989, 9776), (1990, 8679), (1991, 8071), (1992, 8215), (1993, 8076), (1994, 7960), (1995, 9169), (1996, 7950), (1997, 8432), (1998, 8563), (1999, 8358), (2000, 7932), (2001, 7219), (2002, 6801), (2003, 7877), (2004, 7896), (2005, 7716), (2006, 8084), (2007, 8064), (2008, 8387), (2009, 8750)

Recidivism:
actual_change_to_recidivism(t) = actual_change_to_recidivism(t - dt) + (change_to_recidivism_reduction) * dt
INIT actual_change_to_recidivism = potential_deliverable_recidivism_reduction
INFLOWS:
change_to_recidivism_reduction = (potential_deliverable_recidivism_reduction - actual_change_to_recidivism)/time_to_implement_reduction
Reported_Capacity_Utilization(t) = Reported_Capacity_Utilization(t - dt) + (CURRENT_CAPACITY_UTILIZATION - Experienced_Capacity_Utilization) * dt
INIT Reported_Capacity_Utilization = 1
INFLOWS:
CURRENT_CAPACITY_UTILIZATION = Prison.CAPACITY_UTILIZATION/Capacity_Utilization_report_time
OUTFLOWS:
Experienced_Capacity_Utilization = Reported_Capacity_Utilization/(Population.recidivism_detection_time*.5)
Reported_ratio(t) = Reported_ratio(t - dt) + (Current_ratio - Experienced_ratio) * dt
INIT Reported_ratio = Current_ratio*Population.Probation_length
INFLOWS:
Current_ratio = Probation.Actual_worker_to_offender_ratio/Caseload_report_time
OUTFLOWS:
Experienced_ratio = Reported_ratio/Population.Probation_length
Capacity_Utilization_report_time = 1
Caseload_report_time = 1
Completion_time = 1
Equilibrium_switch = .Equilibrium_master_switch
Fraction_potentially_completing_programs = (Less_serious_offender_completion+Serious_Offender_completion)/Total_release
Less_serious_offender_completion = Population.LESS_SERIOUS_OFFENDER_RELEASE_RATE*Short_sentence_length_effect_on_completion
long_sentence_and_completion_ratio = (Attitudes.LongSentence+Population.Parole_Length)/Completion_time
Normal_capacity_utilization = 1
Normal_ratio_of_sentence_to_completion = .96
Normal_Rehab_Effect = rehab_connector
Normal_reported_capacity_utilization = 1
Normal_short_sentence_completion = 1
potential_deliverable_recidivism_reduction = (potential_recidivism_reduction*Effect_of_CAPACITY_UTILIZATION_on_rehabilitation_program_delivery)
potential_recidivism_reduction = Round(Normal_Rehab_Effect*Fraction_potentially_completing_programs*10000)/10000
PRISON_FRACTIONAL_RECIDIVISM = MAX(0,(Attitudes.Prisoner_perception_of_the_benefits_of_crime-actual_change_to_recidivism))
Probation_Recidivism_Fraction = Attitudes.Probatee_perception_of_the_benefits_of_crime*EFFECT_OF_WORKER_TO_OFFENDER_RATIO_ON_RECIDIVISM
rehab_connector = rehab_equilib_input*(1-Rehab_Policy)+((If(time<2007.5)then(rehab_equilib_input)else(Rehab_policy_input))*Rehab_Policy)
rehab_equilib_input = .2*(1-Equilibrium_Switch)+.212164*Equilibrium_Switch
Rehab_Policy = 0

Rehab_policy_input = .4
 Serious_Offender_completion =
 Population.SERIOUS_OFFENDER_RELEASE_RATE*Long_Sentence_length_effect_on_completion
 short_senctnce_and_completion_ratio =
 (Population.LESS_SERIOUS_OFFENDER_Parole_Length+Attitudes.ShortSentence)/Completion_time
 time_to_implement_reduction = 2
 Total_release =
 Round(Population.SERIOUS_OFFENDER_RELEASE_RATE+Population.LESS_SERIOUS_OFFENDER_RELEASE_RATE)
 CAPACITY_UTILIZATION_EFFECT_ON_SENTENCE =
 GRAPH(Experienced_Capacity_Utililization/Normal_reported_capacity_utilization)
 (0.6, 1.34), (0.65, 1.34), (0.7, 1.33), (0.75, 1.33), (0.8, 1.32), (0.85, 1.31), (0.9, 1.30), (0.95, 1.21), (1.00, 1.00), (1.05, 0.795), (1.10, 0.618), (1.15, 0.504), (1.20, 0.45), (1.25, 0.426), (1.30, 0.408), (1.35, 0.396), (1.40, 0.39), (1.45, 0.39), (1.50, 0.39)
 Effect_of_CAPACITY_UTILIZATION_on_rehabilitation_program_delivery =
 GRAPH(Experienced_Capacity_Utililization/Normal_capacity_utilization)
 (0.8, 1.10), (0.85, 1.10), (0.9, 1.10), (0.95, 1.04), (1.00, 1.00), (1.05, 0.9), (1.10, 0.86), (1.15, 0.82), (1.20, 0.805), (1.25, 0.8), (1.30, 0.8)
 EFFECT_OF_WORKER_TO_OFFENDER_RATIO_ON_RECIDIVISM =
 GRAPH(Experienced_ratio/Probation.Normal_ratio)
 (0.00, 1.41), (0.333, 1.34), (0.667, 1.20), (1.00, 1.00), (1.33, 0.933), (1.67, 0.909), (2.00, 0.898), (2.33, 0.888), (2.67, 0.877), (3.00, 0.874), (3.33, 0.87), (3.67, 0.863), (4.00, 0.863)
 Long_Sentence_length_effect_on_completion =
 GRAPH(long_sentence_and_completion_ratio/Normal_ratio_of_sentence_to_completion)
 (0.00, 0.005), (0.2, 0.01), (0.4, 0.055), (0.6, 0.165), (0.8, 0.595), (1.00, 0.75), (1.20, 0.825), (1.40, 0.875), (1.60, 0.93), (1.80, 0.95), (2.00, 0.955)
 Short_sentence_length_effect_on_completion =
 GRAPH(short_senctnce_and_completion_ratio/Normal_short_sentence_completion)
 (0.00, 0.005), (0.2, 0.01), (0.4, 0.055), (0.6, 0.165), (0.8, 0.595), (1.00, 0.75), (1.20, 0.825), (1.40, 0.875), (1.60, 0.93), (1.80, 0.95), (2.00, 0.955)

Appendix 3: First Offender Inflow

As there is no pre existing statistic for the number of offenders who have never been to prison or through the probation system we have created an input based upon the English population and the crime rate. Sentencing statistics give us an indication that approximately 10% of crimes result in sentence. The fraction of first offenders has been taken as 13%. This reflects the number of offenders entering prison who have never before received a caution, fine or other form of punishment. In reality both of the fraction of crimes resulting in sentence and the fraction of first offenders sent to prison would change from year to year. Observation from elsewhere in the system indicate that the first offender fraction, and crime resolution trend actually have quite a low variance.

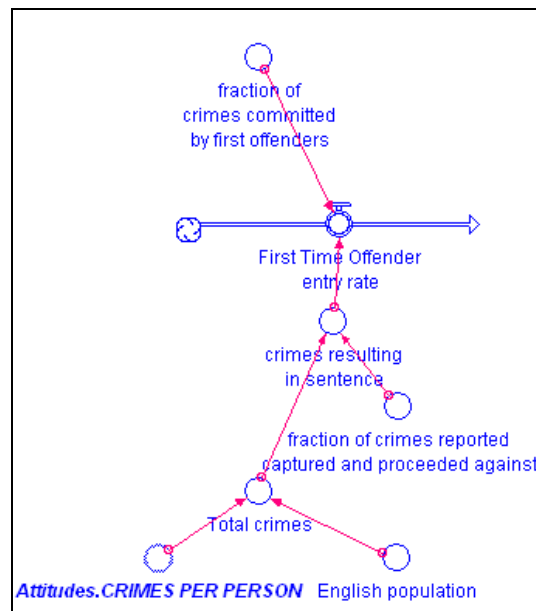

Appendix 4: Extreme Condition Test

If a model continues to operate according to predicted behavior under extreme circumstances we can be more confident that the model operates as intended under normal circumstances. Whilst creating the model each new variable was tested according to its behavior at both ends of the spectrum. Variable equations were only accepted if they

provided the hypothesized behavior or gave grounds to improve the hypothesis. Extreme conditions test were repeated as model structures were connected together. Extreme conditions tests provided key insights into the operation of recidivism and rehabilitation in particular. In this section we will drop a key variable value to zero in each sector²⁰. Extreme values will be applied to sentence lengths, the effectiveness of rehabilitation, and building delays.

- Short Sentence Lengths fall to 0.001

Dropping normal statutory sentence lengths to 0 will produce a division error. In order to test its extreme value we therefore set it to 0.001. It was predicted that with a low short sentence length the prisoner population will instantly fall, as prisoners are released. The prison population would then bounce back as politicians and judges alter sentence lengths. Prison population will eventually fall into equilibrium at a level near 0. Actual sentence lengths will follow the same trend. Capacity utilization will drop sharply, before rising again to a level lower than its initial value. Lower capacity utilization, should invoke Braess law; as capacity increases there is a tendency to use the capacity more – causing sentence lengths to rise once more. The drop in capacity utilization and rise in serious offender sentence lengths will increase rehabilitation and force recidivism to fall.

The predictions were mostly proved correct. However the recidivism rate does not quite behave as predicted. The logic for the actual behavior is quite sound. There is an initial spike in the recidivism rate caused by the sudden release of prisoners. After the spike the recidivism rate falls. The unpredicted behavior is the s shaped growth in recidivism after 1997. As capacity utilization rises once more Braess law has a lower effect on sentence lengths. As sentence lengths go down recidivism increases.

²⁰ These tests were also conducted at extreme high values.

Appendix 6: State of Emergency Policy

The state of emergency policy will involve setting up emergency rule to shorten the delay times in loop B1. Our analysis (in appendix 4) indicated that the system was most sensitive to changes in the cell gap adjustment time. So in the emergency policy, whenever the reported capacity utilization²¹ reaches a certain level the cell gap adjustment time can be reduced – so adjustment takes place over 3 years instead of 5 years whenever capacity utilization is above 1.03.

Equilibrium tests for the state of emergency policy

We tested this policy in equilibrium with a condition that whenever capacity utilization exceeds 1.03 the cell gap adjustment time will drop to 3 years (Figure 68). The policy proved successful in equilibrium. Capacity utilization dropped at a slightly faster rate. The fact that the difference was marginal is encouraging when one considers just how much the population varies from year to year in the real world.

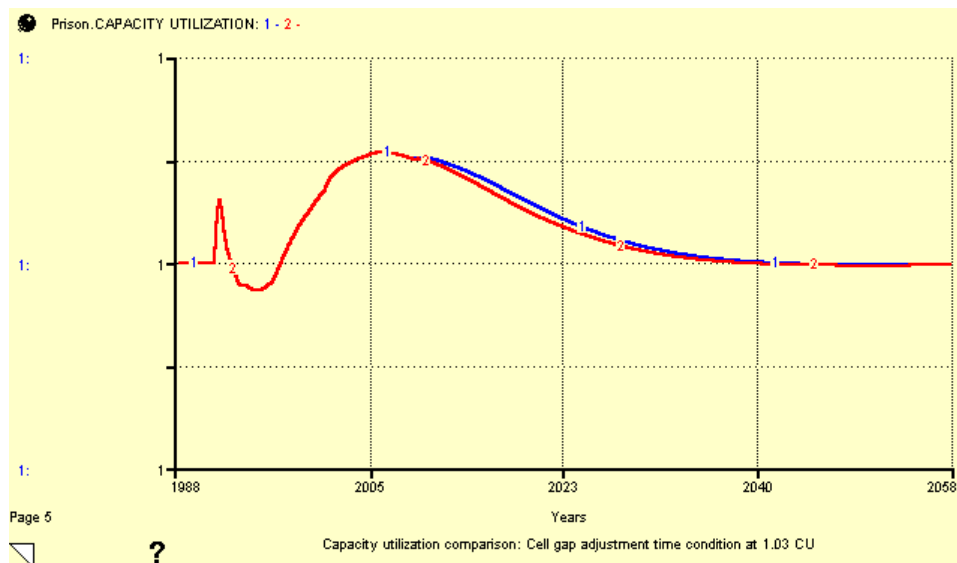

Figure 68: Equilibrium test: Before (1) and after cell gap adjustment policy

State of emergency policy: scenario testing

²¹ Reported capacity utilization is delayed so we are actually talking about 'last years' capacity utilization.

It is clear from the reactions to the three scenarios that reducing the adjustment time does help to relieve problems of a lack of capacity utilization, with only a small risk of running into excess capacity problems. However with an emergency adjustment time of 3 years, there is only a limited gain in scenario's 1 and 2.

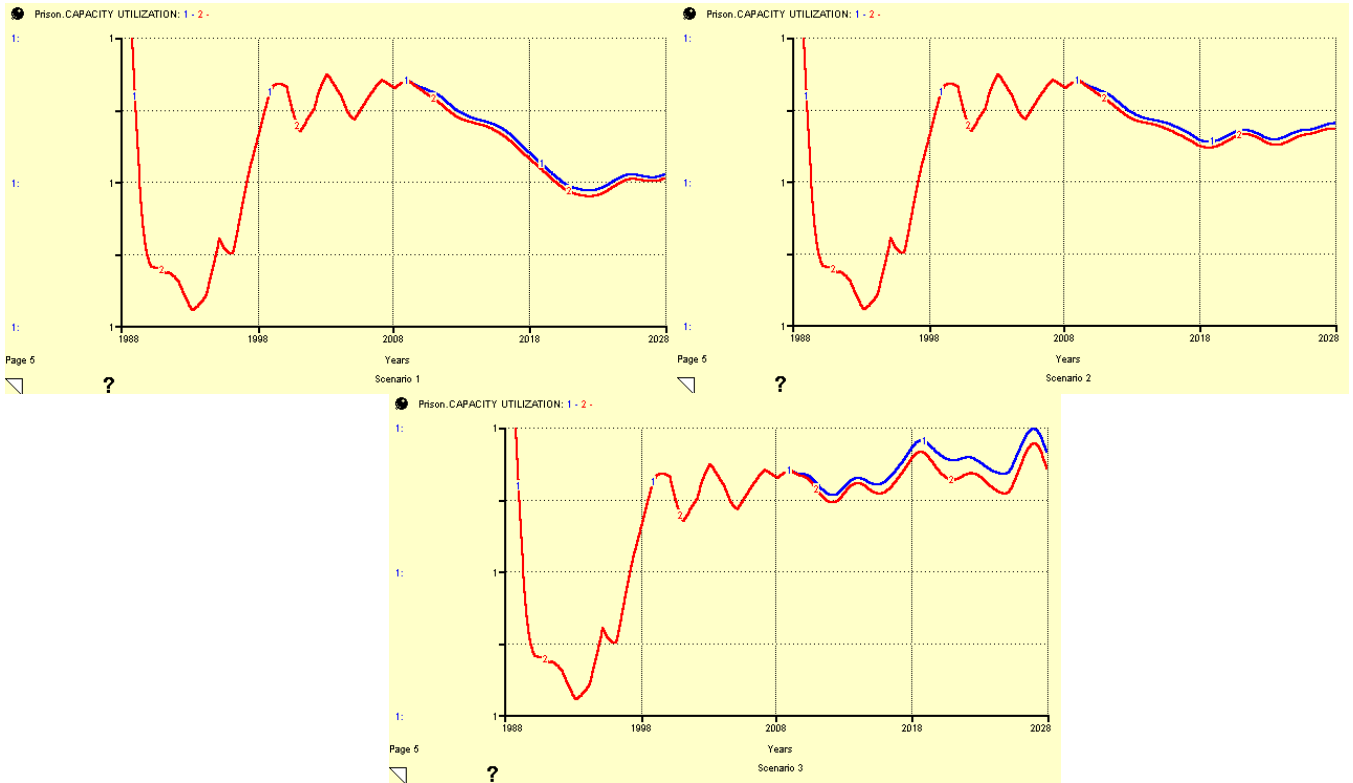

Figure 69: State of emergency under 3 different scenarios.

One of the problems with this policy is that it relies on an instant ‘switch’. The increase in pressure to close the gap between forecast population and forecast capacity is more likely to happen gradually, and it is that gradation that creates a problem. If the shortened capacity adjustment continues for too long the system will overproduce capacity.

Appendix 7: The Publicity Policy: Scenario Testing

The following graphs depict behavior under the “publicity policy”. From 2008 the perception of the crime rate is (1) kept the same, (2) dropped to 1 year, (3) raised to ten years. The changes to the perception of the crime rate produced inconsistent results between the scenarios and was therefore rejected. The graphs below are of scenarios with a

reducing prison population, near flat growth in prison population and a rapidly rising prison population

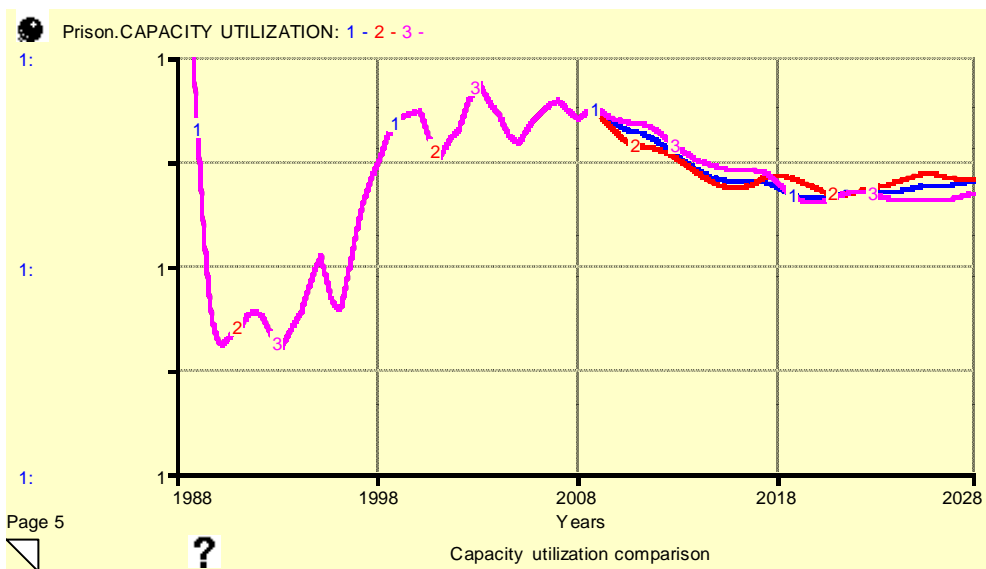
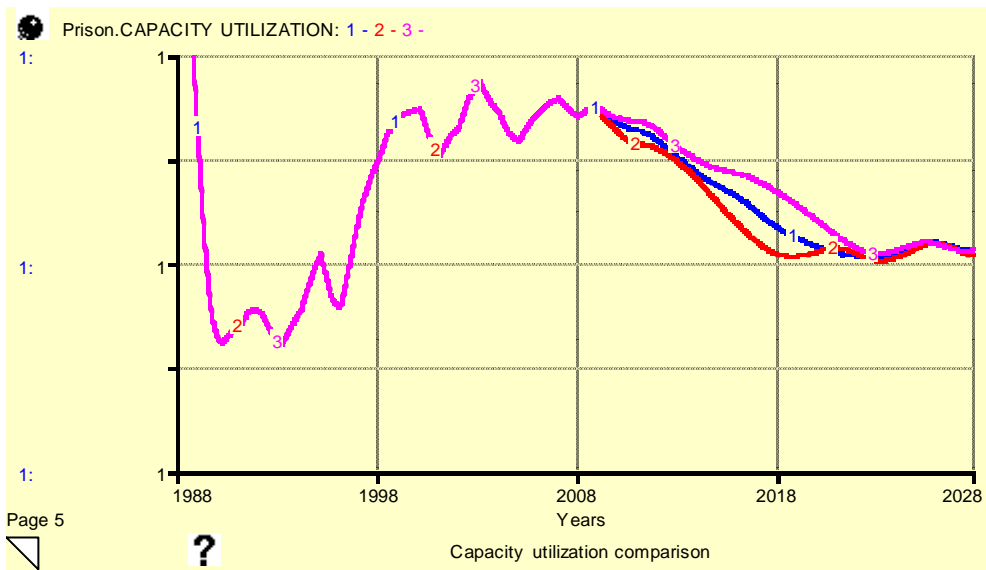

Appendix 8: Guide to the Control Screen of the model

The screenshot shows the iThink 9.1.3 - POLICY MODEL interface. The interface is divided into several sections:

- Interface:** Contains 'Run', 'Pause', 'Wipe graphs', and 'Model' buttons.
- Scenarios:** Includes 'Equilibrium', 'First offenders shock', 'OK Future', 'Nice Future', and 'Horrible Future'.
- Policies:** Features 'Prison, Quick build policy', 'Probation, Custody Extra', 'Abuses, Publicity Policy', 'Recidivism Rehab Policy', 'Recidivism Rehab policy input', and 'Prison State of emergency'.
- Perception adjustment times:** A list of variables with sliders, including 'Abuses, Time to change judicial punitiveness', 'Abuses, time to change political punitiveness', 'Abuses, Time to change public punitiveness', 'Abuses, time to change recidivist perception', and 'Abuses, Publicity change'.
- Graphs:** Two graph pads are visible. The top one is titled '1. UK Minus Capacity Utilization' and '2. Prison CAPACITY UTILIZATION'. The bottom one is titled 'Prison CAPACITY UTILIZATION 1'. Both graphs show 'Capacity Utilization' on the y-axis and 'Years' on the x-axis.

Callout boxes provide the following instructions:

- Top Callout:** Run and pause the simulation, clear the graphs and navigate to the model and front screen.
- Left Callout 1:** Put the system in equilibrium, apply a shock input of offenders in 1998 and change the future scenario.
- Left Callout 2:** Flick these switches to try out policies from the thesis and appendix section. The Rehab Policy slider allows the strength of the policy to be altered.
- Right Callout 1:** Graph pads to display results. Click on the folded corner of the graph (under page no.) to see alternative information.
- Right Callout 2:** Click on a 'minimized' graph to view new information.
- Bottom Callout 1:** Try out new perception adjustment times. Use the Publicity Change variable to alter the strength of the Publicity Policy after 2008. Also enter any variables which you wish to experiment with.
- Bottom Callout 2:** A comparative graph showing different runs of the model on the same graph. Turn the graph pad page to see alternative variables.

Appendix 9: A very basic model guide

Click on the module boxes to see the individual modules

Navigate between the interface, and model views

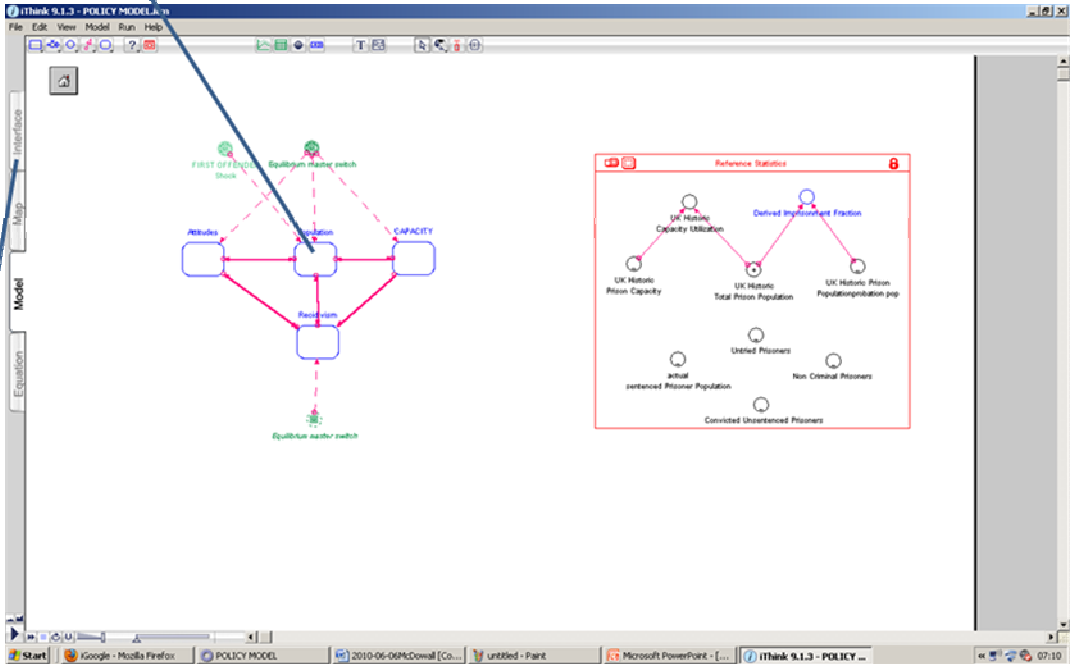

References

- Barclay, G., Tavares, C.(2003) International comparisons of criminal justice statistics 2001, RDS Communications & Development Unit, London: HMSO
- Becker, G. and Landes (1974), *Essays on the Economics of Crime and Punishment*. New York: Columbia University Press
- Berman, G. (2009), *Prison Population Statistics*, House of Commons Library
- British Broadcasting Corporation, January 23 2010, http://news.bbc.co.uk/2/hi/uk_news/politics/8476507.stm
- British Broadcasting Corporation, April 23 2010, http://news.bbc.co.uk/2/hi/uk_news/8640399.stm
- Bottoms, T and Brownsword, R. (1983) *Dangerousness and Rights*, In J.W. Hinton (ed) *Dangerousness: Problems of Assessment and Prediction*. London: George, Allen and Unwin
- Bourne, J. (2005), *National Offender Management Service: Dealing with increased numbers in custody*, Report by the Comptroller and Auditor General, HC 458 Session 2005/2006, National Audit Office
- Carter, P., (2003) *Managing Offenders, Reducing Crime*. London: Strategy Unit.
- Carter, P., (2007), *Lord Carter's Review of Prisons: Securing the future: Proposals for the efficient and sustainable use of custody in England and Wales*, House of Lords.
- Cavadino, M., Dignan, J. (2006) *Penal Systems: A comparative Approach*, SAGE Publications
- Cavadino, M., Dignan, J. (2007) *The Penal System: An introduction*, London: Sage Publications
- Collins, H., A consideration of discretion, offender attributes and the process of recall, In Padfield, N. (ed), *Who to Release?: Parole, Fairness and Criminal Justice*, Willan Publishing
- Ellis, T., Marshall, P., (1998) *Does Parole Work?*, Home Office Research Bulletin. London:HMSO
- European Committee for the Prevention of Torture and Inhuman and Degrading Treatment (2005) *Report to the Government of the United Kingdom*. Strasbourg: CPT
- Gage, W. (2008) *Sentencing Commission Working Group Sentencing Guidelines in England and Wales: An Evolutionary Approach*, London: Ministry of Justice Publications
- Green, D. A. (2007) 'Comparing Penal Cultures: Two Responses to Child-on-Child Homicide', in M. Tonry (ed.) *Crime, Punishment, and Politics in Comparative Perspective*, Vol. 36 in *Crime and Justice: A Review of Research*, pp. 591–643. Chicago, IL: University of Chicago Press.
- Grove, P., MacLeod, J., Godfery, D. (1998) *Forecasting the Prison Population - predicting the consequences of sentencing policy*. OR Insight Vol. 11, Issue 1
- Harper, G., and Chitty, C. (2005) *The impact of corrections on re-offending: a review of 'what works'*. Home Office Research Study No. 291. London: Home Office.
- Hedderman, C. (2008) *Building on sand*, In Hough, M., Allen, R., Solomon E., (eds.) *Tackling Prison Overcrowding: Build More Prisons? Sentence Fewer Offenders*. Bristol: Policy Press.
- Hernández, J., & Dwyer, I. (2001) *Crisis in Colombian prisons: Cause or Consequence of a flawed judicial system?*
- von Hirsch, A., Bottoms, A., Burney, E., and Wikstrom, P-O., (1999) *Criminal deterrence and sentence severity: an analysis of recent research*, Oxford: Hart Publishing

- HM Prison Service (2001) Prison Service Order 1900, Certified Prisoner Accommodation. London: Prison Service
- HM Prison Service <http://www.hmprisonservice.gov.uk/abouttheservice/statementofpurpose>
- Hough, M and Jacobsen, J., (2008) Creating a sentencing commission for England and Wales : an opportunity to address the prisons crisis. London: Prison Reform Trust
- Justice Committee (2008a) Towards effective sentencing, London: Stationary Office
- Kleiman, M. (2009) When Brute Force Fails: How to have less crime and less punishment. Oford: Princeton University Press
- Lacey, N. (2008) The prisoners' dilemma in England and Wales, In M Hough, R Allen, E Solomon, (eds.) Tackling Prison Overcrowding: Build More Prisons? Sentence Fewer Offenders. Bristol: Policy Press.
- Leech, M (2010) Guardian May 28th,
- McKelvie, D., Hadjipavlou, S., Monk, D., Foster, S., Wolstenholme, E., Todd, D. (2007) The use of SD methodology to develop services for the assessment and treatment of high risk serious offenders in England and Wales.
- Mair, G., Mills, H. (2009) The Community Order and the Suspended Sentence order three years on: The views and experiences of probation officers and offenders, London: Centre for Crime and Justice Studies
- Marin, M (2009) Times June 7, Sadistic Sonnex is the face of Labour's greatest disgrace,
- Millie, A., Jacobson, J., Hough, M. (2004) Understanding the growth in the prison population in England and Wales, London: King's College.
- Ministry of Justice (2008) Population in custody monthly tables, England and Wales, Ministry of Justice Statistical Bulletin. London: Ministry of Justice
- Morgan, R. (2008) Where Now?, In Hough, M., Allen, R., Solomon E., (eds.) Tackling Prison Overcrowding: Build More Prisons? Sentence Fewer Offenders. Bristol: Policy Press.
- Newburn, T. (2007). 'Tough on crime: Penal policy in England and Wales', in Crime and Justice: An Annual Review, Tonry, M. and Doob, A. eds). Chicago: University of Chicago Press.
- Orsagh, T. and Chen, J.R. (1988). .The Effect of Time Served on Recidivism: An Interdisciplinary Theory.. Journal of Quantitative Criminology. 4(2): pp. 155-171.
- Padfield, N, and Murana, S., (2006) The revolving door at the prison gate: Exploring the dramatic increase in recalls to prison. Criminology & Criminal Justice; 6; 329. London: SAGE Publications.
- Phillips and Votey (1981) Crime Generation and Economic Opportunities for Youth. In The Economics of Crime Control., Lonson: Sage Publications
- Roberts, J (2003) Public Opinion and Mandatory Sentencing: A Review of International Findings. Criminal Justice and Behaviour, SAGE Online Publication.
- Roberts, J. (2008) Reducing the use of custody as a sanction: a review of recent international experiences, In Hough, M., Allen, R., Solomon E., (eds.) Tackling Prison Overcrowding: Build More Prisons? Sentence Fewer Offenders. Bristol: Policy Press.
- Rouwette, E., van Hooff, P., Vennix, J., & Jongebreur, W. (2007). Modeling crime control in the Netherlands: insights on process. Paper presented at the 25th International Conference of the System Dynamics Society, Boston, MA.
- Stephenson, G., (1995) The psychology of criminal justice, Oxford: Blackwell Publishers

Sterman, J (2000). *Business Dynamics: Systems thinking and modeling for a complex world*. McGraw Hill.

Tabacaru, M. (2006). What we don't measure about human resources: Towards a conceptual framework for analyzing the role of soft variables in human resources management modeling, 23rd international conference of the system dynamics society, Nijmegen, The Netherlands.

The Council Of Europe. (2000) *Prison Overcrowding and Prison Population Inflation*, Recommendation No. R (99) 22 and report, Strasbourg: Council of Europe Publishing

Walmsley, R (2009), *World Prison Population List (8th edition)*, Kings College London, International Centre for Prison Studies

Woolf, H. and Tumim, S. (1991) *Prison disturbances April 1990*, CM 1456 London: HMSO

Wolstenholme E. 2004. Using generic system archetypes to support thinking and modelling. *System dynamics review* 20 (4)

