



# GenSupport

**A generic guideline-based clinical decision support system**

*Master thesis*

*by*

*Dag Vosgraff Skjelvik*

Submitted in partial fulfillment of the requirements for the degree of  
*“Master in Information Science”*

Department of Information and Media Sciences  
University of Bergen

May 2008

## Acknowledgements

---

First and foremost I would like to thank my supervisor Weiqin Chen. She has always been available when I needed advice, and showed a genuine interest in my work. This project would not been possible without her!

To Line: Thank you for always being so patient with me. You are all I will ever need!

To my parents: Thank you for making me realize that education is important and for always supporting me and believing in me.

I would especially like to thank Bjørge Næss for all the good software development discussions and Jan-Erik Bråthen for always putting a smile on my face. Thanks to Audun Vikebakk for listening patiently to me whenever I needed to talk about the obstacles I met in this project.

Bjørge and I developed some of the foundation classes used in GenSupport together; this collaboration was very valuable to me.

I would like to extend my gratitude to Dr Peter Klungsøyr, who was the initiator of this project. I am grateful to Dr Christian Sætersdal and Dr Jonas M. Fevang for the effort they made evaluating GenSupport. I would also like to thank Jørn Klungsøyr.

And last, but not least, I would like to thank all my fellow students for the great student days I had.

Bergen, May 2008

*Dag Vosgraff Skjelvik*

## **Abstract**

---

Clinicians treating congenital clubfoot use paper forms to register and monitor the treatment progress. Routines for registration and archiving are scarce, and the guideline for treating clubfoot is not always followed strictly. A clinical decision support system can be used to improve the treatment by controlling registration of patient information, supervising the treatment process as well as providing advice during treatment.

A generic clinical decision support system named GenSupport has been developed and configured to support clubfoot treatment. GenSupport has been evaluated to investigate whether clinicians can benefit from such a system. The evaluations showed that GenSupport has the possibility of improving the current treatment of clubfoot by providing advice to its users. The clinicians participating in the evaluation believed that GenSupport can improve the routines for registration and archiving of patient information. However, the evaluations have also showed that decisions about what treatment to provide to patients should be made by clinicians with support of the clinical decision support system, not the system alone.

# Table of contents

---

<b>Acknowledgements.....</b>	<b>II</b>
<b>Abstract .....</b>	<b>III</b>
<b>Table of contents .....</b>	<b>IV</b>
<b>List of figures.....</b>	<b>VI</b>
<b>1 Introduction.....</b>	<b>1</b>
1.1 Clubfoot.....	2
1.2 Terms .....	3
1.3 Organization of the thesis .....	3
<b>2 Literature review.....</b>	<b>4</b>
2.1 Artificial Intelligence.....	4
2.2 Clinical decision support systems .....	5
2.2.1 Architecture of CDSS.....	7
2.2.2 Decision support shells.....	8
2.3 Examples of clinical decision support systems.....	9
2.3.1 MYCIN.....	9
2.3.2 System for decision support in hepatic surgery .....	10
2.3.3 Standards-based Shareable Active Guideline Environment.....	11
2.3.4 LogReg .....	11
2.4 Mobile healthcare.....	12
2.5 OpenMRS .....	12
2.6 Research design.....	13
<b>3 GenSupport Framework .....</b>	<b>15</b>
3.1 Requirements specification.....	15
3.1.1 Functional requirements .....	17
3.1.2 Technical requirements.....	17
3.2 Knowledge acquisition .....	17
3.3 Design.....	19
3.3.1 Patients.....	22
3.3.2 Clinicians .....	22
3.3.3 Information needed before entering the workflow.....	23
3.3.4 First general stage.....	23
3.3.5 The domain-specific stage – the guideline .....	23
3.3.6 Steps .....	24
3.3.7 Last general stage.....	28
3.4 Technical implementation.....	28
3.4.1 Technical architecture .....	30
3.4.2 Rules engine.....	30
3.4.3 Knowledge representation .....	32
3.4.4 Step controllers.....	33
3.4.5 Encounter controller .....	34
3.4.6 Flow controller.....	34
3.4.7 Patient controller .....	35
3.4.8 Admin controller .....	35
3.4.9 Database.....	35
3.4.10 Use of open source components.....	37
3.5 System description .....	39
3.5.1 User identification .....	40
3.5.2 System administration .....	40

3.5.3	Main menu .....	41
3.5.4	Register new patient .....	42
3.5.5	Find patient .....	44
3.5.6	List patients.....	45
3.5.7	New encounter .....	47
3.5.8	Steps .....	48
<b>4</b>	<b>Evaluation.....</b>	<b>52</b>
4.1	Evaluation of the rules and rules engine.....	52
4.1.1	Evaluation one.....	53
4.1.2	Evaluation two .....	54
4.1.3	Summary of the evaluation of rules and rules engine .....	55
4.2	Evaluation with domain experts.....	55
4.2.1	Evaluation design .....	56
4.2.2	Conducting the evaluation .....	58
4.2.3	Findings .....	59
4.2.4	Summary and discussion .....	68
<b>5</b>	<b>Conclusion and future work .....</b>	<b>72</b>
5.1	Future work.....	73
5.1.1	Infrastructure.....	73
5.1.2	General improvements.....	74
5.1.3	Library resources.....	75
5.1.4	Explanation .....	75
5.1.5	Domain knowledge editor.....	75
<b>6</b>	<b>References.....</b>	<b>77</b>
	<b>APPENDIX A – Interview guide .....</b>	<b>80</b>
	<b>APPENDIX B – Transcription of interview 1.....</b>	<b>81</b>
	<b>APPENDIX C – Transcription of interview 2.....</b>	<b>84</b>
	<b>APPENDIX D – Transcription of interview 3.....</b>	<b>87</b>
	<b>APPENDIX E – Decision tree errors and warnings .....</b>	<b>89</b>
	<b>APPENDIX F – Clubfoot workflow .....</b>	<b>90</b>
	<b>APPENDIX G – Clubfoot errors and warnings.....</b>	<b>91</b>
	<b>APPENDIX H – Pirani score form .....</b>	<b>92</b>
	<b>APPENDIX I – Rules engine evaluation 1 .....</b>	<b>93</b>
	<b>APPENDIX J – Rules engine evaluation 2 .....</b>	<b>94</b>
	<b>APPENDIX K – Guideline configuration DTD .....</b>	<b>99</b>
	<b>APPENDIX L – Clubfoot configuration XML.....</b>	<b>101</b>

## List of figures

---

Figure 1 General model of a CDSS (Berner, 2007, p. 35) .....	7
Figure 2 Mock-up .....	16
Figure 3 Clubfoot workflow .....	18
Figure 4 Decision tree, clubfoot treatment.....	19
Figure 5 Framework architecture.....	20
Figure 6 Framework entities.....	21
Figure 7 Framework workflow .....	21
Figure 8 Example recommendations and messages.....	22
Figure 9 Step types.....	24
Figure 10 Attribute types.....	26
Figure 11 Sequence diagram .....	29
Figure 12 Technical architecture .....	30
Figure 13 Eval3RulesEngine architecture.....	32
Figure 14 Example guideline xml configuration.....	33
Figure 15 IController interface .....	34
Figure 16 Database EER model.....	36
Figure 17 Login form.....	40
Figure 18 System administration .....	41
Figure 19 Main menu.....	42
Figure 20 Patient information.....	43
Figure 21 Search window.....	44
Figure 22 List patients window .....	45
Figure 23 Encounters window .....	46
Figure 24 List of actions.....	47
Figure 25 Encounter start .....	48
Figure 26 Comments window.....	48
Figure 27 Step navigation.....	48
Figure 28 Data form.....	49
Figure 29 Classification .....	50
Figure 30 Graph.....	50
Figure 31 Recommendations window.....	51
Figure 32 Add action.....	51

Figure 33 Reject action .....	51
Figure 34 Plan action .....	51





# 1 Introduction

---

The treatment of clubfoot using the Ponseti method is as of today not computer supported. Currently, clinician uses paper forms as a tool to monitor the treatment. One of the most important forms is for Pirani scoring. The foot is scored, and the results are plotted with a pen into a graph on paper. Classification results can vary depending on the clinician performing it. Information registered about the patient can be unstructured and archived in an ad-hoc manner and sometimes not archived at all. Thus, there are few possibilities to perform statistical analysis. The treatment process is in some cases ineffective because the Ponseti guideline is not followed strictly. Mistakes made by clinicians during treatment are often discovered too late and this can either corrupt or prolong the treatment process. A clinical decision support system can be used to improve the treatment by controlling registration of patient information, supervising the treatment process as well as providing advice during treatment.

The purpose of this master project is to make a computerized tool that can guide clinicians and ensure that the correct treatment is provided for their patients. The system shall monitor and visualize the treatment process, and guide the treatment to ensure its quality by detection and correction of mistakes and errors. Continuous monitoring will pick up errors made during treatment. Both skilled and novice medical personnel can benefit from using the system.

The research questions that guided this Master's project are:

- How can a clinical decision support system for clubfoot be developed?
- Can clinicians benefit from such a system?

Domain knowledge for the system was provided by Dr Peter Klungsøyr from Department of Orthopaedic Surgery, Ålesund hospital and Dr Tesera Chaeka and Dr Wobalem Zewde from Department of Orthopaedic surgery, Black Lion University Hospital, Addis Abeba, Ethiopia. These have been working together with other domain experts to formalize rules for the system. The rules are used by the system to

## **Introduction**

give advice during treatment, as well as to detect possible treatment errors and issues for follow-up.

Dr Peter Klungsøyr was the initiator of this project. He identified a need for a decision support system to aid the treatment of congenital clubfoot in an Ethiopian hospital where he works periodically as an orthopaedic expert specialized in clubfoot treatment. This project includes the design, development and evaluation of a guideline-based clinical decision support system (GenSupport) to electronically aid the treatment of clubfoot.

### **1.1 Clubfoot**

Clubfoot (Talipes equinovarus) is a congenital condition where the foot is deformed and turns inward and downward (MedlinePlus Medical Encyclopedia). The cause of clubfoot is unknown, but it is most likely a genetic disorder which occurs in approximately 1 in 1,000 babies (Staheli, 2005, p. 26). Clubfoot is the most common birth defect, but in most cases it is easy to treat the condition using mainly non-surgically methods. With the correct treatment the patients can get a normal life with a well-functioning foot.

The Ponseti-Pirani method is a very popular and successful way of treating clubfoot. Clubfoot is treated by this method by combining the Pirani score for classifying the severity of the clubfoot, and the Ponseti method for correction.

Pirani scoring is a standardized way of classifying a clubfoot. This is “*a reliable and valid method of clinically assessing the amount of deformity present in an unoperated congenital clubfoot under 2 years of age*” (Staheli 2005, p. 22). The score is built up of six clinical signs, where each sign is assigned a value as following: 0 - normal, 0.5 - moderately abnormal, 1 - severely abnormal. The final score is the sum of these values, ranging from 0 for a normal foot to 6 for a severe clubfoot.

The Ponseti method of treating clubfoot is fairly new, and is now widely accepted as a valid method. With the use of regular cast, the Ponseti method corrects the clubfoot by weekly corrections supported by the cast. This treatment is guided by the results of Pirani-scoring of the clubfoot. These results are plotted on a graph which visualizes

the treatment progress. After 5-8 weeks the foot is manipulated into the correct position. In most cases the achilles tendon has to be cut in order to prolong it, this process is called tenotomy and is usually done before the last application of cast. The final part of the treatment is to use an orthosis (brace) at night until the foot stabilizes and is fully corrected. Parental compliance to the treatment protocol is crucial, since the orthosis correction process usually takes several years. Inadequate compliance to the orthosis will most likely result in a recurrence of the clubfoot. If the child is older than two years and surgery can be performed at the treating hospital, a small procedure called anterior tibialis transfer (ATT) is performed. After this procedure is performed, the child should not start using the brace.

### **1.2 Terms**

**User:** The person using the system, i.e. a clinician.

**Guideline:** A formalized method describing how to cure a specific illness or condition.

**Treatment:** The process of curing an illness or a condition composed of a series of encounters. How to perform the treatment is usually specified in a guideline.

**Encounter:** One episode in the treatment process. The clinician examines and/or performs a procedure on the patient in the encounter.

**Domain expert:** The provider of the knowledge of the problem domain, generally someone who is experienced within the problem domain (Luger and Stubblefield, 1997, p. 214). The domain expert is primarily responsible of providing domain knowledge to the knowledge engineer.

**Knowledge engineer:** An artificial intelligence and representation expert whose role is to help the domain expert to articulate the necessary knowledge and implement this in a knowledge base (Luger and Stubblefield, 1997, p. 214).

### **1.3 Organization of the thesis**

Chapter 1 introduces the background of the project. Chapter 2 presents the theoretical foundations for the project, along with theories for research design. Examples of relevant systems are also presented. The design and development of GenSupport is presented in chapter 3. The evaluations conducted in the project are described and discussed in chapter 4. Chapter 5 concludes the thesis and provides suggestions for future work on GenSupport.

## 2 Literature review

---

This project is within the field of guideline-based clinical decision support systems (CDSS) (Tu and Musen, 2000). In this section an overview of CDSS and examples of these are provided, along with a description of mobile healthcare and research design.

### 2.1 Artificial Intelligence

Artificial Intelligence (AI) is a field of research that “*strives to build intelligent entities as well as understand them*” (Russel and Norvig, 2003, p. 3). It is problematic to define AI, because the content of the field is constantly evolving. What was formerly considered state of the art AI, might now be commonly used in e.g. kitchen appliances and office automation software and are thus no longer considered being AI by the research community. The threshold between common technology and AI is continuously rising.

According to Passer and Smith, intelligence is the ability to acquire knowledge, reason effectively, and deal adaptively with the environment (Passer and Smith, 2001, p. 337). AI systems can be organized into four categories, i.e. systems that (1) think like humans, (2) act like humans, (3) think rationally or (4) act rationally (Russel and Norvig, 2003, p. 5). This project will consider AI systems as systems able to act rationally, to make the right decisions based on the information and knowledge available.

As a field of research AI is quite new, it was formally initiated in 1956 (Russel and Norvig, 2003, p. 3), although the quest for intelligent machines has been going on for a lot longer than that (Russel and Norvig, 2003, p. 9).

Because of the importance our health and healthcare have for us, the search for new ways of improving medical treatment is always in progress. AI is a field that is especially interesting in this search, because it offers the possibilities to perform intelligent reasoning. Huge amounts of knowledge and information can be combined with high processing abilities to create the theoretically perfect doctor.

AI is commonly used within the medical domain, and has been so since the beginning of AI as a field of research (e.g. Ledley and Lusted, 1959, referenced in Coiera, 2003 p. 331). In medicine AI can be used to provide guidance and advice, supervision and monitoring. Applied within an electronic medical record system, AI can be used to alert when contradictions to planned treatment or changes in the patients medical condition are detected (Coiera, 2003, p. 332). AI can also be used to analyze data and find new patterns, which in turn could lead to new knowledge about a certain medical condition. This field started out as a discipline called Artificial Intelligence in Medicine (AIM), but is now commonly referred to as clinical decision support systems (Coiera, 2003, pp. 331-332).

### **2.2 Clinical decision support systems**

According to (Wyatt and Spiegelhalter, 1991), a CDSS is “*a computer system that uses two or more items of patient data to generate case specific or encounter specific advice*”.

Another definition from (Berner, 1999, p. 4) is that a CDSS is “*a computer-based algorithm that assists a clinician with one or more competent steps of the diagnostic process*”. Berner later modified his definition (Berner, 2007, p. 3):

*“Clinical decision support systems (CDSS) are computer systems designed to impact clinician decision making about individual patients at the point in time that these decisions are made.”*

In other words, a CDSS is a computerized tool that gives advice to the clinicians using it based on information about the patient. A CDSS should not act instead of a clinician. It should rather focus on enhancing the clinician’s performance, considering both accuracy and efficiency, by providing information making its user capable of making better decisions. Early expert systems were intended to provide correct “answers” and diagnoses to clinicians who were passive users of the system, while with CDSS the intention has shifted to provide information to the user in the decision making process (Berner, 2007, p. 4). The human mind has got a limited capability of processing information (Berner, 1999, p. 10), thus a CDSS can be beneficial to use when diagnosis and treatment rely on many variables.

## Literature review

A CDSS primarily needs two things: information about the patient and knowledge about the domain it is performing within. Information about the patient is usually provided by the system's users, and getting this information is in most cases trivial.

Domain knowledge on the other hand can be challenging to synthesize. This is partly because the human experts who have the needed knowledge can be reluctant to share it. Experts have their jobs because of the nature of the knowledge they possess, and they might not give the knowledge away willingly since this can directly threaten their jobs and positions in society. Even though the domain expert is willing to share his/her knowledge, it can be hard to acquire. Some domain experts are not good at explaining their knowledge, and this can cause problems for the non-expert knowledge engineer which then has to learn the problem domain to be able do understand it (Berner, 2007, p. 79). Domain experts can forget to mention details in which have become obvious to them after years of work in their field (Luger and Stubblefield, 1997, p. 215). It can also be challenging to synthesize domain knowledge because of its complexity.

According to (Sintchenko et al., 2003, referenced in Coiera, 2003, p. 338) the benefits of CDSS can be split into three categories: improved patient safety, improved quality of care and improved efficiency in healthcare delivery. The CDSS resulting from this master project is intended to make improvements in all three categories; patient safety and care quality shall be improved by monitoring the treatment, and efficiency will be improved by enabling the clinicians to treat more patients faster.

A CDSS has to fit naturally into the clinical environment it is supposed to function in, and should not change the current workflow more than it has to. The success of a CDSS depends on this because when “*using them [requires] additional effort from already busy individuals*” (Coiera, 2003, p. 333) they might be reluctant to use these systems.

A CDSS can serve two purposes; as a tool for registration of data, and as an intervening factor in the clinical environment. There are several different types of interventions (adapted from Osheroff et al., 2005, pp. 45-56):

- Context sensitive reference information

- Alerts
- Clinician documentation forms
- Display of relevant data

Due to the ability of providing advice on how to perform treatment, “*CDSS have the potential to change the way medicine has been taught and practiced*” (Berner, 2007, p. 3). Both medical students and experienced clinician can perform better using a clinical decision support system (Friedman et al., 1999).

### 2.2.1 Architecture of CDSS

A CDSS is a specialization of an expert system. An expert system is a computerized tool that “*uses domain specific knowledge to provide “expert quality” performance in a problem domain*” (Luger and Stubblefield, 1997, p. 207).

Basic expert systems consist of a knowledge base and a reasoning engine, together with a mechanism which allow the user to communicate with the system (Figure 1) (Berner, 2007, p. 5). The domain knowledge in an expert system is contained in the knowledge base, while the reasoning engine (or inference engine) applies this information to solve problems which is provided through the user interface (Luger and Stubblefield, 1997, p. 210).

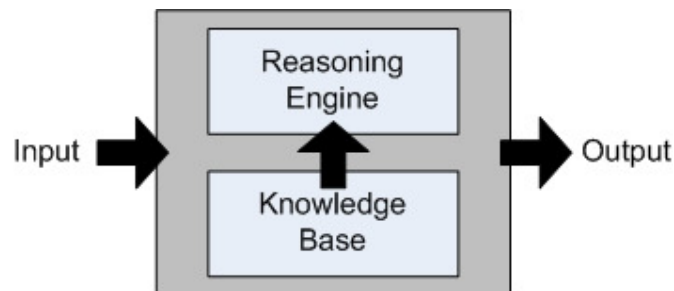

*Figure 1 General model of a CDSS (Berner, 2007, p. 35)*

All domain knowledge to be used by the system is kept in the knowledge base available for the inference engine. In a CDSS, domain knowledge must be acquired, either from an external source or from domain experts at the local hospital. Getting the knowledge from an external source ensures that the knowledge base keeps up with the rest of the medical community, while engineering the knowledge locally can

## **Literature review**

make the CDSS more applicable to the local situation (Berner, 2007, p. 16). The domain knowledge must in most cases be updated regularly to keep up with new regulations and discoveries in medicine (Berner, 2007, p. 17). This is a labor-intensive task, since an altered knowledge base must be re-validated to ensure that the new knowledge is valid and that the existing knowledge has not been corrupted in the process.

Available data about the patient and the knowledge base is used by the inference engine to provide recommendations and alerts. An inference engine can be programmed in several different ways. One type of inference engines, referred to as production rule systems, use predicate logic to form conclusions from the available information (Berner, 2007, p. 38).

The communication mechanism, which is responsible for the communication with the user, must gather patient information. This information can be provided by an external electronic medical record system, or it could be provided manually by the user (Berner, 2007, p.5). Ideally, the CDSS should integrate with an electronic medical record system to avoid that the user must register the relevant information twice (Berner, 2007, p. 11).

The output usually comes in the form of a recommendation or an alert (Berner, 2007, p. 5), often provided directly to the user.

### **2.2.2 Decision support shells**

A decision support shell has all the components of a regular decision support system (Figure 1), with the only difference being that the knowledge base contains no information and it is up to the programmers to create a knowledge base appropriate for their application (Luger and Stubblefield, 1997, p. 211).

Decision support shells can either be full functional decision support systems only needing to be configured with domain knowledge before being ready to use, or they can be components offering decision support functionality within another system. Programmers must then build a decision support system around the decision support shell.



## **2.3 Examples of clinical decision support systems**

### **2.3.1 MYCIN**

MYCIN, the expert system described in Buchanan and Shortliffe (1984), is an early medical expert system based on inference on a knowledge base containing approximately 500 rules. The system “*uses expert medical knowledge to diagnose and prescribe treatment for spinal meningitis and bacterial infections of the blood*” (Luger and Stubblefield, 1997, p. 20). MYCIN uses forward chaining (Buchanan and Shortliffe, 1984, p. 5) to infer a diagnosis based on several rules. This system is considered being a classical expert system, and was one of the first to apply AI in the medical domain.

MYCIN has typical expert system architecture, with a knowledge base and an inference engine (Buchanan and Shortliffe, 1984, p. 3). In addition to this there are components for user interaction and result presentation. MYCIN was later developed to an expert system shell called EMYCIN (Empty MYCIN). This system is based on the domain-independent core of MYCIN (Buchanan and Shortliffe, 1984, p. 302). Because of the separation of domain knowledge from the program, MYCIN could provide a foundation for a more general rule-based system (Buchanan and Shortliffe, 1984, p. 304). Neither the syntax nor the underlying ideas from MYCIN were changed when EMYCIN was developed (Buchanan and Shortliffe, 1984, p. 296).

*“The major conceptual shift in generalizing MYCIN to EMYCIN was to focus primarily in the persons who build new systems rather than in the persons who use them”.*

(Buchanan and Shortliffe, 1984, p. 296)

MYCIN was developed to aid users in decision support, while EMYCIN was developed to reduce the effort needed of a knowledge engineer when helping an expert (Buchanan and Shortliffe, 1984, p. 297).

Similar to EMYCIN, GenSupport started out as a domain-specific CDSS, and ended up as a CDSS shell. It includes general components and can be customized easily with domain-specific knowledge.

## Literature review

### 2.3.2 System for decision support in hepatic surgery

Dugas et al. constructed a CDSS for hepatic surgery. The system was designed, implemented and tested to investigate whether a decision support system can provide clinically relevant information (Dugas et al., 2002). The system has been integrated to a clinical setting, and it provides decision support for the surgeon and the patient during risk assessment prior to critical surgery. Similar cases are stored in a database and retrieved when needed to provide guidance in the risk assessment process. The process of “*reasoning directly from collected examples of previous problem-solving experiences*” is called case-based reasoning (Luger and Stubblefield, 1997, p. 209). The main purpose of using data about previous patients is to determine which patients can “*benefit from specific procedures based on survival and complication rates*” (Dugas et al., 2002).

Similar to GenSupport, the system by Dugas et al. provides graph visualization to aid decision making. Similarities are also found in the problem domains; previously decisions have been made based on the clinician’s expertise and intuition (Dugas et al., 2002).

Dugas et al. also discussed success factors for CDSS. The tool must be fast and easy to use, and the system must provide a comprehensible benefit for the user (Dugas et al., 2002). The clinician’s work flow must be integrated in the system, and the knowledge base should provide the clinician with the opportunity to view full patient data (Dugas et al., 2002). They suggested gathering as much data as possible, since retrospective data collection is expensive, difficult and prone to errors.

An important point made by Dugas et al., which has also lead the design of the decision support system in this project, is that “*clinical decisions are and should be taken in the foreseeable future by doctors and their patients, not by machines*” (Dugas et al., 2002). This is extremely important because of several factors. Machines can obviously make mistakes, both because they are made by humans and because of the occasional errors. Another factor is diagnostics and treatment of patients whose disease progress deviate from the ordinary. A CDSS might not have the sufficient data to provide neither the correct diagnose nor the correct treatment.

CDSS should be used to improve the decisions made, not making them. The CDSS developed in this project will monitor the progress of the treatment and give advice to clinicians. It is ultimately the clinician's decision to accept or ignore the advice from the system.

### **2.3.3 Standards-based Shareable Active Guideline Environment**

The Standards-based Shareable Active Guideline Environment (SAGE) is quite similar to the GenSupport project, although it is intended for use on desktop computers. It seeks to help solve the same problem as GenSupport does; computerizing clinical guidelines and providing decision support. A benefit of SAGE is that clinical guidelines can be encoded using standard terminologies and standards-based patient information models (Tu et al., 2007, p. 589), amongst these HL7 and Snomed CT.

One of the primary bottlenecks identified in the SAGE project is developing and maintaining the knowledge bases. This work is described as being a labor-intensive collaborative process involving domain experts and computer scientists (Tu et al., 2007, p. 597). The open-source knowledge base editor Protégé is used to transform knowledge to a format readable to the SAGE system (Tu et al., 2007, p. 590). Using this editor requires skilled knowledge engineers due to its complexity.

### **2.3.4 LogReg**

LogReg is a decision-support shell which runs on handheld computers (Zupan et al., 2001). This system utilizes decision models encoded in XML to provide decision support. Availability on the location at which the decisions are made is considered as the reason for choosing a mobile platform for the system. As in GenSupport, the system is entirely configured with the XML file and the configuration process does not involve programming or re-compilation of the system. Several XML files can be loaded in the system at the same time, available to the user. LogReg applies logistic regression models for reasoning, and this is a limitation to the possibilities of the system. However, the LogReg framework can be extended to other modeling techniques (Zupan et al., 2001).

## **Literature review**

LogReg is intended for single encounters only, and does not provide decision support for treatments with multiple encounters, as GenSupport does.

### ***2.4 Mobile healthcare***

Providing suggestions to the users at the time and location where the decision is made is identified as a success factor for CDSS (Kawamoto et al., 2005). Mobile technologies can improve responsiveness in healthcare and increase productivity (Siau and Shen, 2006, p. 90). Size and mobility are key benefits of mobile devices. The portability of the mobile devices enables clinicians to access and register patient information wherever they prefer (Lu et al., 2005, p. 413).

Patient information and medical knowledge must be available at the mobile device, thus data exchange is an important aspect of mobile healthcare. XML is a format suitable for data exchange across devices, platforms and organizational units, as long as they agree on the content of the data exchanged (Siau and Shen, 2006, p. 92).

Mobile devices are technically inferior to desktop computers. A small low-resolution screen and limited computational abilities makes it challenging to implement user-friendly and complex applications (Siau and Shen, 2006, p. 95). Slow entry of data is another problem with mobile devices (Embi, 2001, p. 849). Data entry is usually done with a pen directly on the device's screen by plotting letters on a keyboard displayed on the screen. Most mobile devices do not support efficient and effective handwriting recognition.

Mobile devices are increasingly popular in the medical domain (Lu et al., 2005, p. 410). By 2013, it is expected that hospitals will use more mobile than stationary computers (Haux, et al., 2002, p. 13).

### ***2.5 OpenMRS***

Open Medical Record System (OpenMRS) is an electronic medical record system developed as an open source project. It is led by the Regenstrief Institute (<http://www.openmrs.org>), and the system is primarily aimed at medical care in developing countries. OpenMRS is purely an electronic medical record system, and does not contain any features for decision support.

OpenMRS is built around the OpenMRS data model, which is based on the more than 30-year old Regenstrief model ([http://openmrs.org/wiki/Data\\_Model](http://openmrs.org/wiki/Data_Model)). This data model provides the generic foundation needed to represent the relevant information about a patient and his/her condition and treatment. GenSupport utilize this flexibility and parts of the OpenMRS data model are adapted and applied in the GenSupport framework.

### **2.6 Research design**

Research design is the process of choosing and tailoring methods and aspects from existing research methodology to fit the research project. The GenSupport project is about the design, development and evaluation of a CDSS which is intended to clinicians' performance when treating clubfoot. Based on this, the project fits into the description of design research. According to Hevner et al. design research "*seeks to extend the boundaries of human (..) capabilities by creating new and innovative artefacts*" (Hevner et al. 2004, p. 75).

An important part of a design research project is to demonstrate that the artefact created actually fulfils its purpose within the problem domain. To determine this, an evaluation has to take place. In the evaluation it is interesting to look at how well the application works, and whether it can increase the efficiency of the treatment method. According to Randolph A. Miller, the main focus when evaluating a CDDS should be "*whether the user plus the system is better than the unaided user with respect to a specified task*" (Miller, 1996, p. 429).

Evaluation of computer systems used within healthcare differs from evaluations on "regular" computer systems. Since these systems have direct effects on humans, several ethical questions arise. An important ethic question is if the participation in the research project is voluntary. The patients affected by the system should be able to choose by themselves whether to participate or not. Another important ethical aspect is how to handle possibly sensitive personal data.

Errors in a CDSS can lead to erroneous diagnoses. Therefore it is extremely important to focus on error prevention when developing the CDSS. When testing a CDSS, its functionalities must be validated and verified to avoid consequences to the

## **Literature review**

patients being treated with support of the system. First, the application must be thoroughly tested outside the patient care arena and when warranted it can be tested in the actual patient care environment (Berner 1999, p. 19).

Evaluations can be in a formative or a summative manner. Formative evaluation is done during development, and is intended to unveil what can be done to improve the artefact being evaluated (Robson, 2002, p.208). Focus users of the artefact should participate in a formative evaluation, this helps to ensure that the finished artefact satisfies its intended purpose. Summative evaluations are performed to assess the effects and effectiveness of the artefact (Robson, 2002, p. 208). Usually, summative evaluations focus on the total impact of the artefact, not simply which predefined goals are achieved (Robson, 2002, p. 208). Evaluations can be both formative and summative at the same time, summative evaluations often has an effect on later development of the artefact (Robson, 2002, p. 208).

GenSupport has been evaluated both formatively and summatively. Observation, think-aloud and semi-structured interviews were used in sessions with three domain experts. The evaluations have been conducted to both improve the prototype and to assess whether GenSupport could have a positive effect on the domain in interest.

### 3 GenSupport Framework

---

This chapter describes the GenSupport framework, and how it was designed and developed. This phase of the project has been split in two major parts:

1. Requirements specification and design
2. Development

Dr Klungsøyrr was the initiator of this project. He identified a need for a decision support system to aid the treatment of congenital clubfoot in Ethiopian hospitals. He has been the domain expert and user of this project.

User-centered systems design (UCSD) (Gulliksen et al., 2003) was chosen as the method guiding the design and development process of the GenSupport framework. UCSD is defined as “*a process focusing on usability throughout the entire development process and further throughout the system life cycle*” (Gulliksen et al., 2003, p. 401). This approach focuses on good communication between the participants of the project.

Dr Klungsøyrr has been involved continuously throughout the design and development processes. The project was conducted in an iterative manner to ensure that the final product satisfies the need of the intended users. An incremental prototype was built and used throughout the development phase. The prototype was first used to communicate requirements between developer and user, and was later developed into the finished GenSupport system.

The design was not frozen before starting the development phase. Changes in the requirements were allowed throughout the project, this was necessary to create a system which facilitates the users’ needs.

#### **3.1 Requirements specification**

The requirements for the system were specified during several meetings with Dr Klungsøyrr. A low-fidelity mock-up (Figure 2) of the system was made based on the information gathered at the first meeting, to clarify the requirements and possibilities of the system. This was needed for the developer to understand the needs of the user,

## GenSupport Framework

and for the user to understand the possibilities and limitations of the project. The mock-up was refined through several iterations, where the user reviewed the mock-up, and changes were made thereafter.

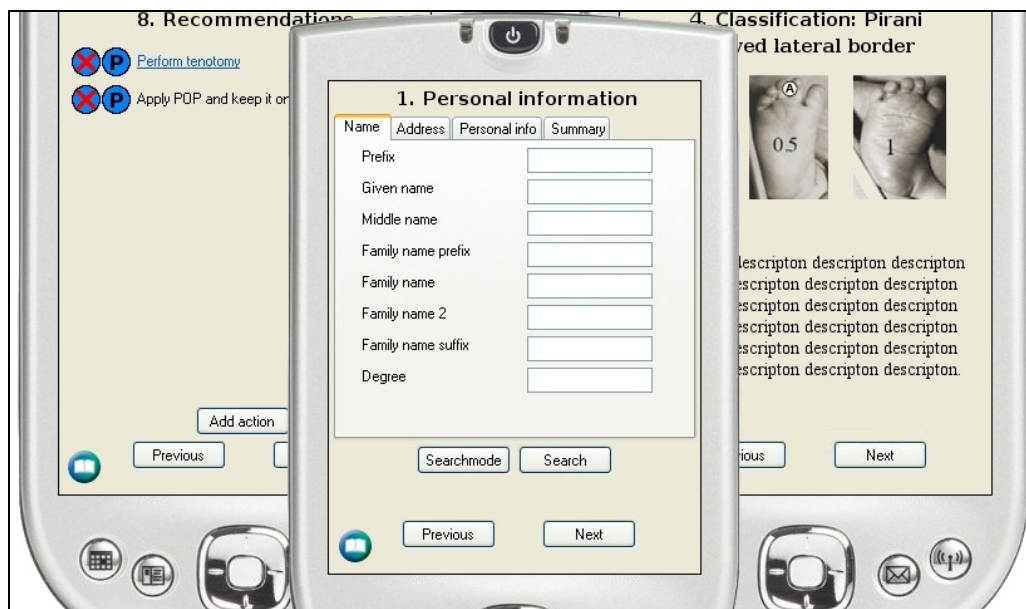

*Figure 2 Mock-up*

Dr Klungsøyrr works as an orthopaedic expert both at Ålesund hospital and at Black Lion hospital in Ethiopia. Many of the clinicians working at Black Lion hospital are less experienced in the treatment of clubfoot. Dr Klungsøyrr has registered that the treatment provided is not optimal and in need of improvement. The documentation of the treatments is also poor. Information is registered on paper forms, but the routines for archiving these are not very strict.

Dr Klungsøyrr believed that the current situation can be improved with a computerized tool able to register patient information and to provide expert advice on how to proceed with further treatment. A system is proposed that could guide the main clubfoot treatment process, and be able to guide the follow-up after the treatment is finished. The targeted users for the application are trained clinicians treating clubfoot.

The best opportunity for a CDSS to deliver interventions is usually when the pertinent persons can be reached with the intervention and are prepared to act upon the



information immediately (Osheroff et al., 2005, p. 42). Handheld computers are the most versatile in a stressful clinical environment, and are also proven to function successfully in these environments (Turner et al., 2005). This, in addition to the possible lack of infrastructure in the environments which Dr Klungsøyrr works, is why handheld computers are chosen to be the device where this system should run.

Based on Dr Klungsøyrr's needs and suggestions, those specified in the meetings and those communicated through the mock-up, requirements for a decision support system was concretized.

### **3.1.1 Functional requirements**

- Registration of core patient information.
- Registration of attributes of the clubfoot.
- The system shall provide treatment recommendations based on pre-defined rules and information registered by the clinicians using it.

### **3.1.2 Technical requirements**

- It should be possible to run the application stand-alone, or as a part of a client-server structured network.
- The system should run on a handheld computer, running a Windows Mobile operating system.

## ***3.2 Knowledge acquisition***

The process of acquiring the necessary knowledge is central when developing a clinical decision support system. This is often a tedious process (Berner, 2007, p. 79), and in this case the knowledge was acquired and refined throughout the project. Dr Klungsøyrr provided domain knowledge.

The knowledge engineering process was done in several iterations. First, Dr Klungsøyrr made a diagram describing how clubfoot is treated (see appendix F). This diagram described the entire process of clubfoot treatment, in addition to all the phases of the treatment. The diagram describes how a clinician proceeds to treat clubfoot, thus it had to be converted for GenSupport to be able to utilize it. The workflow for each encounter of the clubfoot treatment was extracted to a new model

## GenSupport Framework

(see Figure 3, preconditions have been omitted for readability). This model shows all steps possible for the clinician to go through at each encounter. Preconditions determine when it is appropriate to include a step in the workflow. For example, the step “Pirani score right foot” would not be included in the workflow for a patient where only the left foot is affected.

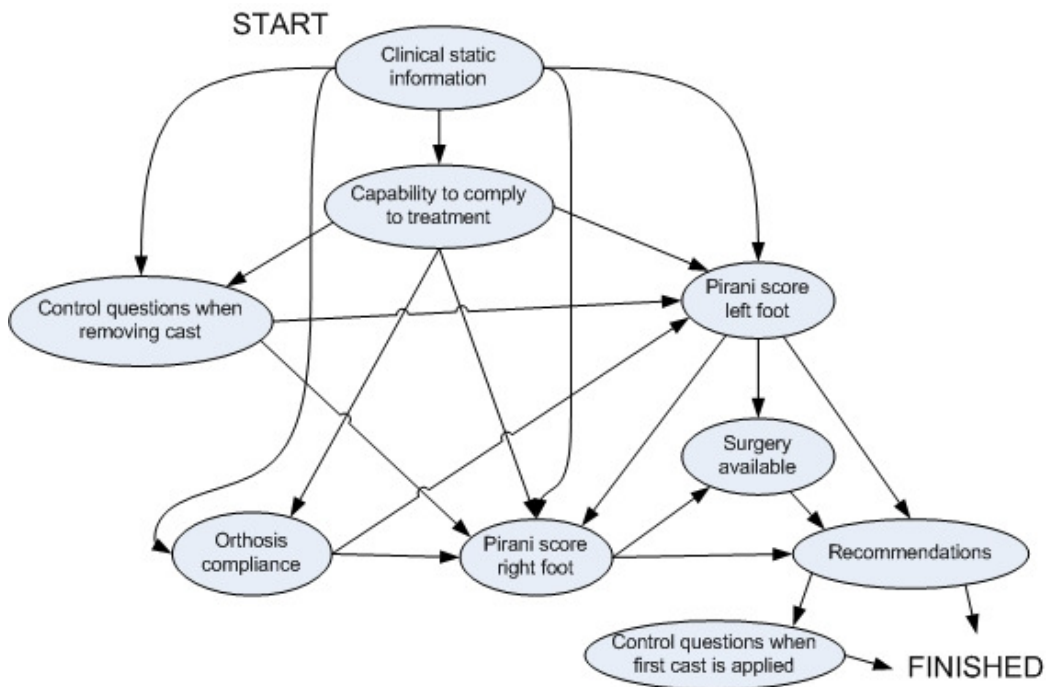

*Figure 3 Clubfoot workflow*

The rules for providing treatment recommendations was also extracted, and put into a decision tree (Figure 4). These models were used further in the knowledge engineering process as a communicating artefact to communicate with the domain expert. The models were also used to guide the design phase.

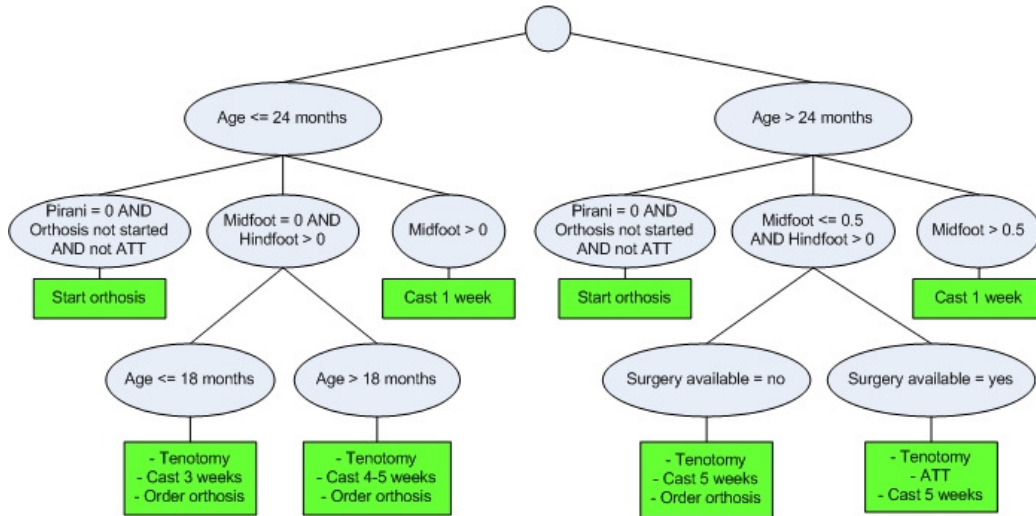

Figure 4 Decision tree, clubfoot treatment

A configuration file based on the new models was made for GenSupport. The validity of the extracted rules was checked with Dr Klungsøyr before.

### 3.3 Design

The main goal of the system is to support the treatment of clubfoot by providing decision support and easy data registration. Recommendations will be triggered by rules on the attributes about the patient and its condition gathered using the system.

A high level architecture of the GenSupport framework was designed (Figure 5), based on common structures for decision support systems and expert systems (Nilsson, 1998, p. 281, Berner, 2007, p. 35).

The domain knowledge is acquired from a domain expert, and engineered into a configuration file compliant to the GenSupport standard. The configuration file is validated by a document type definition (DTD), and provided to the knowledge base where it is available for the rules engine to use. Clinicians communicate with the system through the user interface which is controlled by the GenSupport main controller. This controller gathers information and forwards it to the rules engine which applies the domain knowledge contained in the knowledge base to provide advice. These advices are presented to the user through the user interface. The GenSupport main controller makes sure that all relevant information from the session is sent to the system storage.

## GenSupport Framework

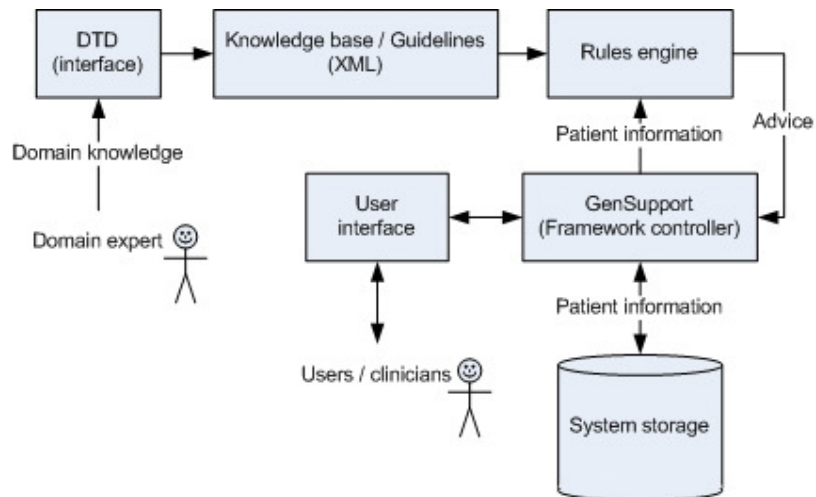

*Figure 5 Framework architecture*

The architecture was designed to follow object-oriented principles (Sommerville, 2007, pp. 313-338) and the Model-View-Controller approach (Sommerville, 2007, p. 371). All knowledge has been separated from the controlling logic in the framework. Because of this separation, GenSupport can be used as a general framework for supporting clinical guidelines. This design choice enhances the flexibility of the system, as well as simplifies updates and modifications to the domain knowledge later in the life cycle of GenSupport.

Because of the separation of domain knowledge and the controlling logic, the domain knowledge must be provided to the framework separately. This will be done by defining a guideline configuration file (see 3.4.3).

Five main entities were identified in the framework (Figure 6): clinicians, patients, hospitals, guidelines and encounters. These are related to each others. Clinicians have rights to use specific guidelines in specific hospitals. Hospitals have clinicians, guidelines and patients. Patients are treated by a clinician in a hospital with the aid of a guideline in an encounter. Patients usually have a responsible clinician as well. The patient treatment is composed of these 5 entities.

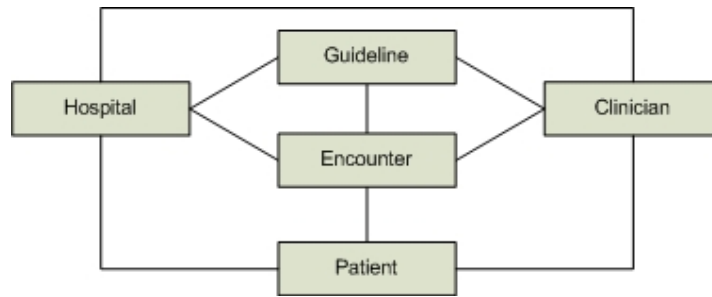

Figure 6 Framework entities

GenSupport supports the workflow for each encounter which finds place between the clinician and the patient. Three stages have been identified in this workflow (Figure 7). Which hospital, patient and clinician the encounter concerns must be defined before entering the workflow. The workflow starts with a general stage where the clinician chooses which date the encounter takes place. The next stage is domain-specific and defined in the guideline describing the given condition. Lastly, in the third stage, the user should give comments on the encounter. The domain-specific workflow for the clubfoot guideline is shown in Figure 3.

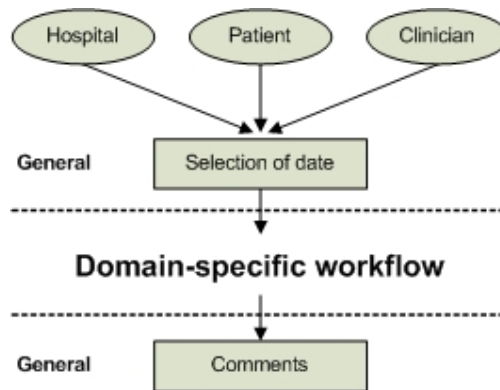

Figure 7 Framework workflow

Depending on the customization, the framework can act as a full-feature clinical decision support system, or as a simple tool for data collection.

The framework shall suggest various kinds of recommendations to its users. The precondition for suggesting the recommendation is specified by logical expressions in the guideline configuration file. These expressions can be built using all the available information about the patient. This includes the treatment history and all the information provided in the steps preceding the step where the recommendations are

## GenSupport Framework

provided. Complex expressions can be defined by combining patient attributes with standard mathematical and logical operators. For example, a precondition can be:

$$\text{Midfoot} \leq 0.5 \text{ AND } \text{Hindfoot} > 0$$

Each recommendation is a suggestion from the framework to the user to perform a certain action. These actions can be rejected or planned. In addition to suggesting which actions to perform, the framework can also provide warning and error messages. These messages are warnings to the user whenever something in the treatment is erroneous or likely erroneous (see Figure 8 for examples).

<b>Recommendation</b>	<i>Cast right foot for three weeks</i>
	<i>Perform tenotomy on left foot</i>
<b>Warning</b>	<i>Warning! Check treatment of right foot</i>
<b>Error</b>	<i>ERROR! Check treatment of left foot</i>

*Figure 8 Example recommendations and messages*

### 3.3.1 Patients

Core patient information is kept in the system; this contains general information about the patient which is independent of the guideline chosen. This is standardized information (adapted from the data model of OpenMRS) which is not possible to customize. Core attributes of the patient are:

1. Name of the patient
2. Residence / Address
3. Next of kin
4. Health center
5. ID numbers

### 3.3.2 Clinicians

The clinician must identify himself/herself to be able to use the system, for security reasons. It is extremely important that confidentiality is kept considering the potentially sensitive personal information registered in the system. All users of the framework are identified by a user name and a password. Information about the

clinician using the framework, such as name and user privileges, is retrieved by using the user name. This affects which actions the clinician is allowed to take.

### **3.3.3 Information needed before entering the workflow**

Since the framework supports multiple guidelines, the user must specify which guideline to use in the current workflow. Which hospital the treatment will reside in, which patient will be treated and the treating clinician must also be specified.

The workflow can also be entered without specifying which patient the encounter concerns. The purpose of this feature is to offer the system's abilities of decision support based entirely on information provided during the given encounter. In a stressful treatment-setting this can be useful. The system can then be used to assess whether a patient should be treated or not. This feature should only be used with patients that are not already registered in GenSupport.

### **3.3.4 First general stage**

The clinician has to choose/verify the desired date on which the encounter will take place before entering the domain-specific workflow. It is necessary for the clinician to be able to set a date back in time, since (s)he might not always be able to access the system on the actual date of the encounter.

### **3.3.5 The domain-specific stage – the guideline**

This part can be fully customized by those implementing the framework. Guidelines are composed of a series of independent steps. There are basically two types of steps; those gathering and presenting information, and those giving recommendations.

A guideline is composed of mainly three parts; metadata about the guideline, treatment actions possible to carry out while using the guideline, and a collection of workflow steps. A step is a part of the guideline, a module which can either collect and view information or provide recommendations. Steps and step types are described in the following part.

## GenSupport Framework

The metadata of the guideline contains information about (adapted from Shiffmann et al., 2000):

- Guideline title
- Main author
- Description
- Date created
- Change log

The steps in the guideline are linked together in a specific sequence. It must be specified in the guideline which step is the first. All steps but the last ones have a collection of succeeding steps. The succeeding steps must be defined with preconditions in order to allow branching of the workflow. These preconditions must be mutually exclusive, since only one step can succeed another.

### 3.3.6 Steps

The steps are the building blocks of the guidelines. These can be of several different pre-defined types (Figure 9). The different step types needed were identified in the requirements specification phase. The steps in the framework could either be permanent or encounter-specific. Permanent steps are general for all encounters of a guideline, while the encounter-specific steps must be completed at each encounter.

General for all steps is:

- A title
- A description
- A collection of succeeding steps with a precondition defined for each step

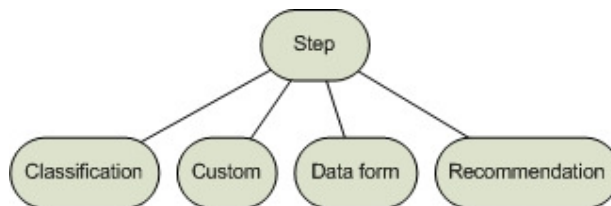

*Figure 9 Step types*

The next step is chosen by the system's flow controller (see 3.4.6) from the step's collection of succeeding steps. If there are no steps in the collection with a



precondition evaluated as true, the workflow is finished and the user is prompted with the last general stage (see 3.3.7).

### **3.3.6.1 Classification**

In this type of step the user can perform a classification of multiple attributes about a patient's condition. A classification is composed of one or more classification steps; each step is intended to classify a group of coherent attributes of the patient or his/her condition. The purpose of grouping coherent attributes is to be able to treat the values of these attributes as a unit, both in logical expressions and for summarizing purposes.

For each attribute in the classification there is:

- A title describing the attribute.
- A description of the attribute and the values possible for the attribute. This description is meant to enhance the clinicians' understanding of the attribute they are classifying and help them make a better and more precise classification.
- A set of pictures depicting the possible values for the attribute.

In every classification step the user must choose a value for the each attribute. The values are fixed pre-defined numeric values. The value of the attribute classified is provided by the user by selecting an image representing the correct value.

After classifying all the attributes, a summary is shown to the user. The values are presented in a graph, showing a line for each group of attributes in addition to a line representing the total sum of all the attributes. Results from earlier classifications are displayed in the graph as well, so the user can see the development in the patient's condition.

### **3.3.6.2 Data form**

The data form is used to gather and display information of attributes about a patient and his/her condition, including those needed for the system to be able to give recommendations. This step type is basically a collection of attributes about the

## GenSupport Framework

patient, the condition or the treatment. The attributes can be grouped to enhance the logical coherency of the step.

### 3.3.6.2.1 Attributes

An attribute's main properties are a title and a description. The attributes can be of several different types (Figure 10):

- String: Information about literal attributes e.g. name. Maximum length of the string can be defined.
- Text: Free-text information.
- Numeric: Information about numeric attributes. These attributes can be limited with a minimum and a maximum threshold. Number of decimals can also be specified.
- List: Lets the user choose a value from a pre-defined list of values for the attribute.
- Boolean: Information about bi-valued attributes. Values for true and false can be added (e.g. yes or no, man or woman, positive or negative).
- Date: Information about dates.

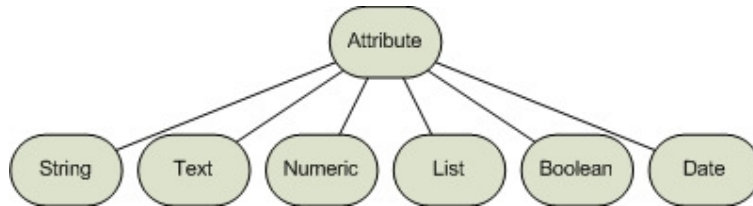

Figure 10 Attribute types

### 3.3.6.3 Recommendation

This module invokes the rules engine, fires the rules specified in the guideline configuration and presents the resulting recommendations, errors and warnings. It is also responsible for managing the user's response to these advices. The user can choose to reject the recommendations or plan actions according to the recommendations. (S)he can also add actions manually.

In addition to giving recommendations, GenSupport can also provide warning and error messages to the clinician. A warning message is given when something *could be*

wrong, i.e. when there are reasons for suspecting that the treatment is not progressing as normal and special measures must be taken to prevent the treatment going wrong. When something indicates that the treatment most likely has gone wrong, an error message is provided to the user.

### ***3.3.6.3.1 Rejecting recommendations***

The clinician can choose to reject the recommendation. According to (Osheroff et al., 2005, p. 74) there are standard reasons for rejecting treatment recommendations:

- MD disagrees with recommendation
- Recommendation already implemented
- Alert fired inappropriately
- Patient ineligible for recommended intervention
- Patient refuses recommended intervention
- Others

These standard reasons are implemented in the framework. The user should also provide a comment explaining why the overriding was done.

### ***3.3.6.3.2 Planning***

It is not always possible or feasible to perform the recommended action instantly. This calls for the need to be able to plan the actions. In the framework it is possible to postpone an action, and plan for when to perform it. A date must be specified, and the user should state a comment about why the action is postponed.

### ***3.3.6.3.3 Manual invocation***

The clinicians are able to manually invoke an action, because (s)he believes that a certain action is correct to perform under the given conditions even though GenSupport has not suggested it. The clinician can choose amongst the actions which are specified in the current guideline. When choosing an action manually, the clinician should specify the reason for this.

### ***3.3.6.3.4 Rule tuning***

Rules defined in a decision support system are not necessarily optimal. The rules could have been misunderstood by the knowledge engineer in the process of

## **GenSupport Framework**

formalizing the rules (Kendal and Creen, 2007, p. 96), or the rules can turn out to be sub-optimal under the conditions the decision support system is working under. The knowledge must thus be reviewed and verified thoroughly (Kendal and Creen, 2007, p. 131).

It is stressed in the framework that the user should provide a reason for acting differently than the system suggests. These reasons which could be specified when planning, rejecting or manually invoking an action makes a good basis for tuning the rules in the guideline. Rule tuning is usually a process going on for the complete life cycle of a clinical decision support system.

### **3.3.6.4 Custom steps**

To satisfy all possible requirements of clinicians using the framework, there is possible to add custom step types to the framework. This has to be done by the implementers of the system, since this customization requires technical skills in the current version. The implementations of custom steps are done by extending the necessary interfaces.

### **3.3.7 Last general stage**

The user has the possibility to make notes about how the treatment proceeded in this last stage. Though not mandatory, this is highly recommended because these comments are an important source of rich data about the specific encounter.

## **3.4 Technical implementation**

Due to the decision about using Windows Mobile as the platform for the system, C#.Net was chosen as the main programming language for the implementation of GenSupport. The .Net environment has good support for developing applications for handheld computers running Windows Mobile.

The main controller in GenSupport is the class called GenSupport (Figure 11). First, the GenSupport class uses the FormLogin window (1) to collect login information from the user. If the login information matches a stored user, the FormMainMenu will be presented (4). If the login information matches an administrator of the system, the ControllerAdmin (see 3.4.8) is launched (2). This class will show the FormAdmin

window (3) to allow the administrator to edit the setup information of GenSupport. The process is controlled by the ControllerAdmin class, and control will be returned to GenSupport when it is finished.

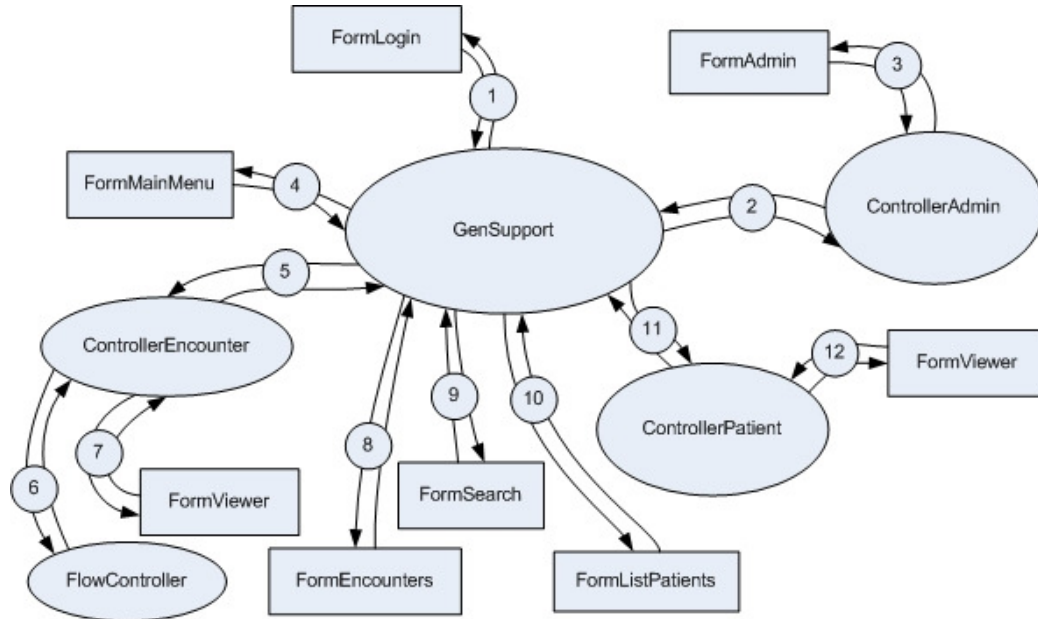

*Figure 11 Sequence diagram*

If the user chooses to register a new encounter, or to edit an already registered one, ControllerEncounter (see 3.4.5) will take over control (5). This controller uses a FlowController (see 3.4.6) to control the workflow of the encounter (6). For each step in the encounter, the ControllerEncounter will request FlowController for a new step controller (see 3.4.4), and pass the user interface of the step to the FormViewer (7). When the encounter is finished, ControllerEncounter will return a DataEncounter object to GenSupport, which will store this in the data layer.

GenSupport use FormEncounters (8) to present a list to the user of the encounters which the patient has gone through. If the user wants to edit or view an encounter, this is done by passing the control to the ControllerEncounter (5). This process is described above.

If the user wants to search for patients, GenSupport shows the FormSearch window (9). The search criteria entered is returned to GenSupport, and this is used as a basis for a filter for the results showed in FormListPatients (10). This window can also be

## GenSupport Framework

accessed without setting a criterion, and then all patients in the system will be displayed.

ControllerPatient (see 3.4.7) is used to register and edit patient information (11). This class will pass a generated user interface to the FormViewer class (12). ControllerPatient returns a Patient object to GenSupport, which stores this in the data layer.

### 3.4.1 Technical architecture

GenSupport follows a standard three-layer architecture with a data layer, a controlling layer and a presentation layer, i.e. data, logic and presentation is separated (Figure 12).

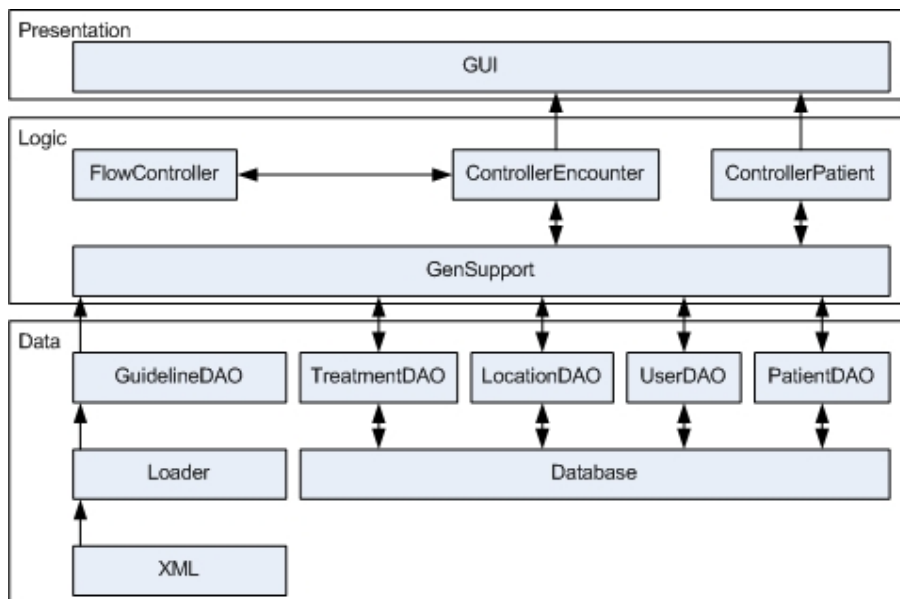

Figure 12 Technical architecture

### 3.4.2 Rules engine

GenSupport needs to evaluate many rules in order to be able to provide recommendations to the clinicians. Different alternatives have been considered. The conclusion was that there were no rules engines available which could suit the needs of GenSupport. There were few rules engines which run on the Windows Mobile platform, and those who did had license terms which was not suitable to a project like

GenSupport which is intended to be a free clinical decision support system, it was not an option to select a rules engine the users had to pay for using.

C Language Integrated Production System (CLIPS) (<http://clipsrules.sourceforge.net/>) which is an expert system shell, was considered as a candidate for rules engine for GenSupport. Originally initiated by NASA in 1984, CLIPS has been continuously refined through the years, and is now open source and free to use. CLIPS is written in the unmanaged<sup>1</sup> C language, and a port to .Net was considered for GenSupport. After trying to compile this port, it was discovered that it relied on a lot of methods not available in the down-scaled .Net Compact Framework.

The solution was to build a rules engine from scratch around the Eval3 evaluator (see 3.4.10.7), called Eval3RulesEngine. This rules engine has a decision tree, an agenda and an instance of the Eval3 evaluator (Figure 13). The decision tree is composed of two kinds of nodes; internal nodes and leaf nodes. Internal nodes have a list of child nodes, while the leaf nodes have a list of statements. The decision tree is represented by a reference to the root of the tree, which is a regular internal node.

When the Eval3RulesEngine is run, it will parse the decision tree depth-first and evaluate the conditions of the rule found at each node. Internal nodes evaluated as true will be expanded, whilst the tree will be cut at those internal nodes having a condition evaluated as false. When a leaf node is evaluated as true, its statement will be placed on the agenda of the Eval3RulesEngine. The agenda is a list of the statements contained in the leaf nodes evaluated as true. This list is available after the execution is finished. The rules engine parses the full decision tree, not stopping at the first leaf node evaluated as true.

---

<sup>1</sup> Unmanaged programs execute directly on the computers CPU, while managed programs executes under management of a virtual machine. Managed code is slower but safer than unmanaged code. Examples: C and C++ are unmanaged languages, while C# and Java runs in a managed environment.

## GenSupport Framework

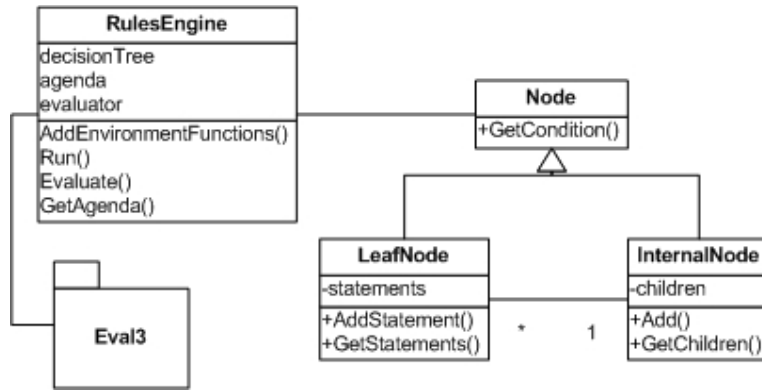

Figure 13 Eval3RulesEngine architecture

### 3.4.3 Knowledge representation

All domain specific knowledge in GenSupport is provided by the implementers in a guideline configuration xml file (see Figure 14 for an edited example).

```
<?xml version="1.0" encoding="UTF-8"?>
<!--DOCTYPE GenSupportConfiguration SYSTEM "configuration.dtd"-->
<GenSupportConfiguration>
  <Metadata>
    <Title>Clubfoot</Title>
    <Author>Dag Skjelvik</Author>
    <Description>A test implementation of a guideline for clubfoot
treatment</Description>
    <DateCreated>01.02.2008</DateCreated>
  </Metadata>
  <Actions>
    <Action Id="right_cast3w">Cast right foot for 3 weeks</Action>
    .....
  </Actions>
  <Step Id="clinical_static_information" Static="true" FirstStep="true">
    <Title>Clinical static information</Title>
    <Description>Clinical static information</Description>
    <NextStep>
      <Condition>GetSequenceNumberOfCurrentEncounter() = 1</Condition>
      <StepID>capability_to_comply_to_treatment</StepID>
    </NextStep>
    .....
  <DataForm>
    <Tab>
      <Title>Clubfoot</Title>
      .....
      <Group>
        <Title>Right side</Title>
        <Field Id="right_side_tenotomy_performed">
          <Title>Tenotomy performed?</Title>
          <Boolean>
            <True>Yes</True>
            <False>No</False>
          </Boolean>
        </Field>
        .....
      </Group>
      .....
      <Field Id="previous_treatment_place">
        <Title>Previous treatment place</Title>
        <String/>
      </Field>
      .....
    </Tab>
    .....
  </DataForm>
  .....
</GenSupportConfiguration>
```



```

    </DataForm>
  </Step>
  .....
  <Step Id="recommendations" Static="false">
    <Title>Recommendations</Title>
    <Description>Recommendations</Description>
    .....
    <RecommendationSet>
      <Node>
        <Condition>Encounter.GetStep("clinical_static_information").GetStringValueOfField("side_affected") = "Bilateral" OR
        Encounter.GetStep("clinical_static_information").GetStringValueOfField("side_affected") = "Right"</Condition>
        <Node>
          <Condition>Patient.GetAgeInMonths(Encounter.Date) &lt;=
24</Condition>
          <Node>
            <Condition>GetTotalScoreClassification("pirani_right_foot") = 0 AND
            Treatment.ActionNotPerformed("right_orthosis") AND
            Treatment.ActionNotPerformed("right_att")</Condition>
            <Statement>
              <Recommendation Id="recommendation1">
                <ActionID>right_orthosis</ActionID>
              </Recommendation>
            </Statement>
          </Node>
        </Node>
        .....
      </Node>
    </Node>
    <Node>
      .....
    </Node>
  </RecommendationSet>
</Step>
.....
</GenSupportConfiguration>

```

*Figure 14 Example guideline xml configuration*

The configuration file contains metadata about the guideline, a collection of actions which the clinicians can perform while following the guideline and a collection of steps (see 3.3.5).

Each step has a title and a description, in addition to a set of references to preceding steps with respective preconditions. A step can be either a data form for collecting and displaying data, a classification where the user can choose amongst different values for a set of attributes or a recommendation set which is used by the rules engine to provide recommendations (Figure 9).

### 3.4.4 Step controllers

For each step there is a step controller implementing the IController interface (Figure 15). Implementing this interface is necessary to be compatible with the encounter controller (see 3.4.5).

## GenSupport Framework

```
namespace GenSupport.FlowControl {
    public interface IController {
        String GetTitle();
        void SetTitle(String title);
        Control GetGUI(Size contentSize, Mode mode);
        DataStep Save();
        Boolean Finished();
        StepModel GetModel();
        void Init(Patient patient, DataStep dataStep, DataEncounter dataEncounter,
        DataTreatment dataTreatment, ConfigGuideline configGuideline);
    }
}
```

*Figure 15 IController interface*

GenSupport is a generic system, thus can not rely on static forms to display information. The forms are therefore generated “on-the-fly” from an object structure which is based on the xml file configuring the guideline. Each step controller has the responsibility of doing this.

### 3.4.5 Encounter controller

The encounter controller (see Figure 12) controls the workflow of a guideline. When the user begins working on an encounter, the control is passed from the GenSupport main controller to the encounter controller. The encounter controller requests the next step in the workflow from the flow controller (see 3.4.6) each time the user of GenSupport clicks “Next”. It is managing the complete encounter process, and when the encounter is finished, it returns a DataEncounter object containing all the information from the encounter to the GenSupport main controller which has the responsibility of saving it.

### 3.4.6 Flow controller

The sequence of the steps in a guideline is controlled by an object named FlowController (see Figure 12). The flow controller has a tree representing the paths in the flow and an Eval3 Evaluator (see 3.4.10.7). The tree is composed of FlowNodes which has a reference to an IController object and a list of preceding FlowNodes with preconditions. It also has a list representing the path to the current flow node to allow back tracking.

When the encounter controller requests the next step in the sequence, the children of the current node are then iterated, and the first child having a pre-condition evaluated as true is returned as next in the workflow.

### 3.4.7 Patient controller

The patient controller has the responsibility for gathering and displaying patient information. It displays a form in which the user can register a new patient. If called with an existing patient as an argument, it allows the user to edit the information registered on the patient. When the user is finished editing or registering the patient, the patient controller returns a patient object to the GenSupport main controller which is responsible for saving the object.

### 3.4.8 Admin controller

ControllerAdmin is the controller responsible for the administration and configuration of GenSupport. It enables users with administrator rights to add and edit users and hospitals. The administrators can also add and remove guidelines as well. ControllerAdmin is invoked by the GenSupport main controller when the user provides a username and password defined as the administrator's. This username and password is hard-coded in the GenSupport main controller, and is by default admin/admin.

### 3.4.9 Database

All the information gathered by GenSupport is stored in a relational database. Microsoft SQL Server 2005 Compact Edition was chosen as the database engine in GenSupport. This is an embeddable version of the SQL Server 2005, and it is free to use and to redistribute. The database engine installed automatically on the handheld device together with the application using it, and it is run in process<sup>2</sup> with the application. This makes the database engine invisible to the users of GenSupport. Microsoft SQL Server 2005 Compact Edition has good support for data synchronization, and this allows a simple process of developing GenSupport further to support a client-server structure.

GenSupport access the Microsoft SQL Server 2005 Compact Edition database through a singleton called SqlCeSingleton. This singleton will create a database file

---

<sup>2</sup> Microsoft SQL Server 2005 Compact Edition runs in process. That means it is executed in the same process as the program it is embedded within, and not in a separate process as e.g. Microsoft SQL Server 2005 does.

## GenSupport Framework

with the needed tables (Figure 16) the first time it is called after installing GenSupport. The SqlCeSingleton will continue to use this database as long as it is available. A System.Data.SqlServerCe.SqlCeConnection is provided for the objects calling the SqlCeSingleton.

As shown in Figure 12, all communication with the database in GenSupport is done through data access objects (DAOs). This is a flexible structure which makes it easy to exchange the data layer. Data access objects are instantiated by a factory. By using this structure, it is possible to exchange the complete data layer by providing a different DAO factory to the system.

Information from the general parts of the system is stored directly in the database, and each piece of information has its own column in a table. Information from the customizable part of the system is wrapped in xml before it is stored in the same database.

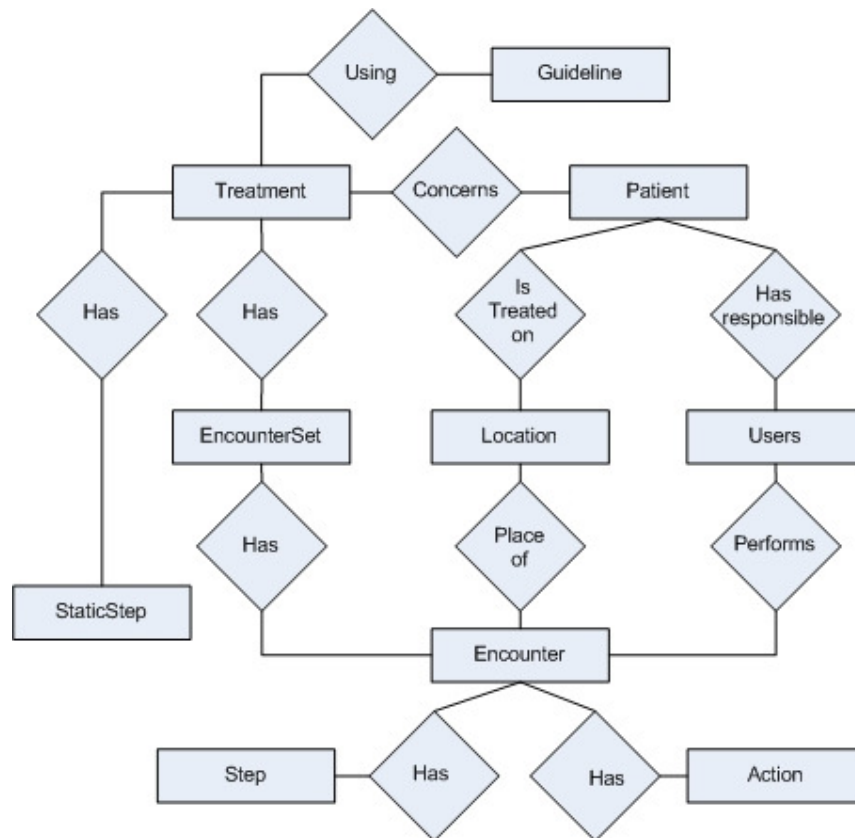

Figure 16 Database EER model

### 3.4.10 Use of open source components

Existing open source components have been used in GenSupport to save development time. Most of these components are introduced to deal with shortcomings in the down-scaled .Net Compact Framework, i.e. functionalities that are available in the full-scale .Net Framework but has been removed to make the compact framework suitable for a lightweight platform such as Windows Mobile.

The quality of open source components can vary, since these are usually not provided with a guarantee of any kind. Some components are used “as it is”, while others are modified to suit the intended use in GenSupport or to improve the occasional sub-optimal solutions in the open source components. The components are described with reference to the class name which they have in the GenSupport Visual Studio solution, which functionalities they offer and which problem they solve. A brief description of the modifications done to the respective components is also provided.

#### 3.4.10.1 GenSupport.GUIObjects.MyClickableLabel

This class is originally made by Dean Cleaver, and can be found at [http://www.opennetcf.org/forums/topic.asp?TOPIC\\_ID=48](http://www.opennetcf.org/forums/topic.asp?TOPIC_ID=48). The class handles the problem that the standard System.Windows.Forms.Label class does not implement a click-event. Modifications are done regarding font settings, and the name of the method “TextAlignment” is change to “TextAlign” making it consistent with the method name in the System.Windows.Forms.Label.

#### 3.4.10.2 GenSupport.GUIObjects.MyComboBox

A limitation of the .Net Compact Framework 2.0 which is used in this project is that one is not allowed to set the width of the dropdown list in a System.Windows.Forms.ComboBox. This is possible both in the regular .Net Framework and in the Windows Mobile API. This limitation represents a usability problem, especially when the list of the System.Windows.Forms.ComboBox contains long strings. I have adapted the class ComboBoxExtender made by Alex Yakhnin to make the class MyComboBox. Original source code can be found at <http://blog.opennetcf.org/ayakhnin/PermaLink,guid,85942117-e560-47cb-a41a-b0ec006147c5.aspx>. The adapted class solves the width problem by calling the native API with the platform invoke methods available in the .Net framework.

## **GenSupport Framework**

The original class extends the `System.Windows.Forms.ComboBox` by using a kind of composition. The intention is to use the `ComboBoxExtender` as a tool to set the properties of the `ComboBox`. I have adapted the class to extend `System.Windows.Forms.ComboBox` by using inheritance. This is a better solution because `MyComboBox` can be used instead of the original `System.Windows.Forms.ComboBox`, and the programmer will only have to deal with one class.

### **3.4.10.3 GenSupport.GUIObjects.MyCursor**

This class is courtesy of Mark Artega, and offers functionality for displaying a wait cursor which provides the users of GenSupport an indication that the system is working when a resource-demanding operation is running. If no such indication is provided to the user, (s)he will most likely believe that the system is not responding to his/her actions. Original code can be found at <http://blog.markarteaga.com/IDisposableCursor.aspx>. No modifications are made to this class.

### **3.4.10.4 GenSupport.GUIObjects.MyDateTimePicker**

There is a class in the .Net framework called `System.Windows.Forms.DateTimePicker`, this class shows a calendar which enables the user to choose a date in a convenient manner. Current date is set as default value for the `System.Windows.Forms.DateTimePicker`, and there is no way of knowing whether the user has actually chosen the date current date or done nothing. Pham Minh Tri has written a nullable `DateTimePicker`, whose original source code can be found at [http://www.codeproject.com/KB/selection/Nullable\\_DateTimePicker.aspx](http://www.codeproject.com/KB/selection/Nullable_DateTimePicker.aspx).

The modified `DateTimePicker` solves this problem by not showing a date by default. It returns the `System.Windows.Forms.DateTime.MinValue` if a date has not been set by the user. In this way it is possible to check if the user has set the date or not. The class was originally written for desktop applications, and I have ported it to the .Net Compact Framework by modified it to react on the correct events for the Windows Mobile platform.

### 3.4.10.5 GenSupport.GUIObjects.MyGroupBox

In the standard .Net Compact Framework there is no way of grouping items in a form. The `OpenNETCF.Windows.Forms.GroupBox` by OpenNETCF Consulting (<http://www.opennetcf.com>) provides various ways of grouping items. `MyGroupBox` is a simplified version of `OpenNETCF.Windows.Forms.GroupBox`, all but the functionalities needed for basic grouping is removed.

### 3.4.10.6 MobilePractices.OpenFileDialogEx.OpenFileDialogEx

In .Net Compact Framework there is a class called `System.Windows.Forms.OpenFileDialog`, which allows the user to select a file. This class is limited in terms of only allowing the user to browse certain parts of the file system on the handheld computer. The `OpenFileDialogEx` allows the user to browse the full file system. No modifications are done to this class.

### 3.4.10.7 Eval3

GenSupport needs to evaluate logical expressions at run-time. Both the workflow controller and the rules engine need this functionality. The .Net Compact Framework does not provide good functionality for evaluating complex expressions. An external library called Eval3 provides the evaluating functionalities needed in this project. It parses expressions represented by strings, and returns the truth value of the expression.

Eval3 supports common operators for number manipulation, Boolean operators and comparison operators. It is easy to expose objects to the Eval3 evaluator; this makes it powerful and easy to extend. Variables and functions from other objects can thus be used in expressions. Eval3 is written by Pascal Ganaye, and is available at <http://www.codeproject.com/KB/recipes/eval3.aspx>.

The Eval3 library is used “as is”, without modifications. I have only compiled the library to a dynamically linked library and imported it in the GenSupport project.

## 3.5 System description

In this section the different functions and interfaces of the framework are described.

## GenSupport Framework

### 3.5.1 User identification

This is the first screen the clinician meets when using the system (Figure 17). A username and a password must be provided to identify the clinician. When the clinician presses the “Log in” button, the user name and password which (s)he provided is verified. If the log in information is incorrect, an error message is shown. If everything is approved, the user proceeds to the main menu of the system (see 3.5.3).

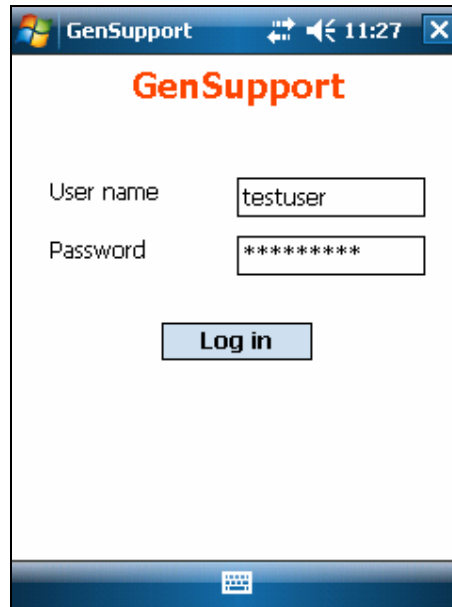

*Figure 17 Login form*

By using the administrator user name and password when accessing the system, a special system administration menu is presented to the user (see 3.5.2).

### 3.5.2 System administration

Some configuration is needed before using the system. GenSupport is generic, thus no changes to the original source code is needed unless the guidelines need functionality which is not standard.

There are three tabs in the system administration window (Figure 18), making the administrator able to register and edit information about users having access to the system, locations where treatments can find place and configuration files for the guidelines which will be used in the system.



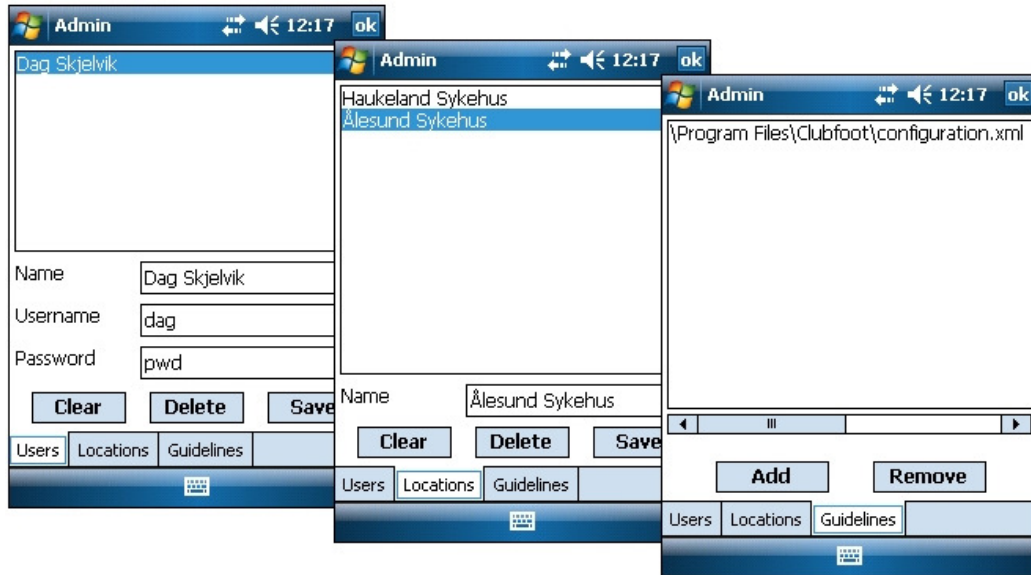

Figure 18 System administration

When registering a user, the administrator has to provide the user's (clinician's) name, desired user name and password. Only those registered here will have access to the system. Locations are only registered by name. Guidelines are added by choosing the xml file containing the configuration of the system. When pressing "Add", the user is prompted with a dialog from which (s)he can choose the configuration file from.

### 3.5.3 Main menu

After a successful login, the user is presented with the main menu (Figure 19). Before being allowed to access other functionalities of GenSupport, the clinician must choose which hospital the session will reside in. Since some clinicians work at several hospitals, this information can not be inferred from the clinician's user profile. Secondly, the clinician must also choose which guideline to use in the current session, because the system can be configured with several guidelines. The default values for hospital and guideline are the first values in the lists which the clinician can choose from.

After choosing hospital and guideline, the clinician has four options: register new patient (see 3.5.4), find an already registered patient (see 3.5.5), list all patients (see 3.5.6) or register new encounter (see 3.5.7). These options are further elaborated below.

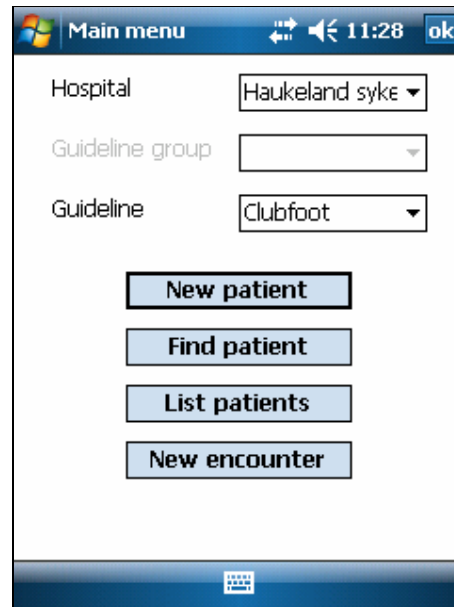

*Figure 19 Main menu*

If the clinician chooses “New encounter” from the main menu, (s)he will start to register an encounter without having chosen a patient up front. A new patient must then be registered at the end of the encounter if the information registered shall be stored in the system.

### **3.5.4 Register new patient**

All the information about the patient which is not guideline-specific is registered and displayed in this part of the system (Figure 20).

*Figure 20 Patient information*

The window where the user can access patient information consists of four parts, grouped and presented to the user in a tabbed layout. First, there is information about the name of the patient. The name of a patient can be quite complex, depending on the culture and the part of the world which the patient originate from. Most common name structures should be covered in this system, since it is based on the OpenMRS data model. Only three pieces of information about the patient is mandatory: first name, family name and birth date. These fields are used to identify the patient.

The second part is person information, and concerns information about, amongst others, birth date, gender, next of kin and health district. Birth date can also be used in rules concerning the patient's age.

The next part is ID numbers; three different identifiers for the patient can be registered here. "Person ID no" is the same as social security number, "Hospital ID no" is an identifier specific to the hospital, while "Study ID no" can be used if the patient participates in a study of some kind.

In the fourth and last part called "Address", information about all the common address properties in addition to co-ordinates are presented. Main hospital for the patient can also be registered.

## GenSupport Framework

When the clinician clicks “Save” (s)he will be prompted if any of the mandatory information is not provided. If all the mandatory information is provided, the patient information will be stored, and the clinician gets a question if (s)he would like to continue to registering an encounter. If the clinician declines, the main menu will be showed again.

### 3.5.5 Find patient

The clinician can find a patient which is already registered in the system by choosing the menu option “Find patient” (Figure 21). The clinician can choose between “Simple search” and “Advanced search”. The results from the search are displayed in the window called “List patients” (see 3.5.6). The information entered in the search form works as a filter for the list displayed in this window.

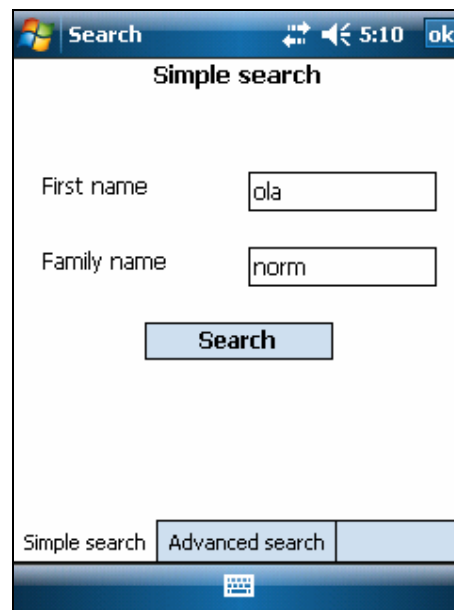

*Figure 21 Search window*

In simple search mode, the patients can be sought after by first name and family name. The clinician can provide the full name, or parts of it.

Advanced search mode is not yet implemented, but the intention is to allow the clinician to use all the fields which is available when registering patient information to set a filter for the search. All the core patient information would then be searchable.

### 3.5.6 List patients

The list of patients (Figure 22) is showed if the clinician chooses to view all patients from the main menu, or it is used to display the results of a search. In the list patients window the clinician has options regarding patient administration and encounters.

The clinician can add a new patient by clicking the button labeled as “New”, whereby the window for registering patient information (3.5.4) is presented to him/her. If the clinician wishes to remove the patient from the system, the button labeled as “Delete” will start this procedure. The clinician will be prompted by the system and asked to confirm that (s)he really wants to proceed. Already registered patient information can be edited by clicking the button labeled as “Edit”. The window for registering patient information will then be opened, and the clinician can edit the information which is stored about the patient.

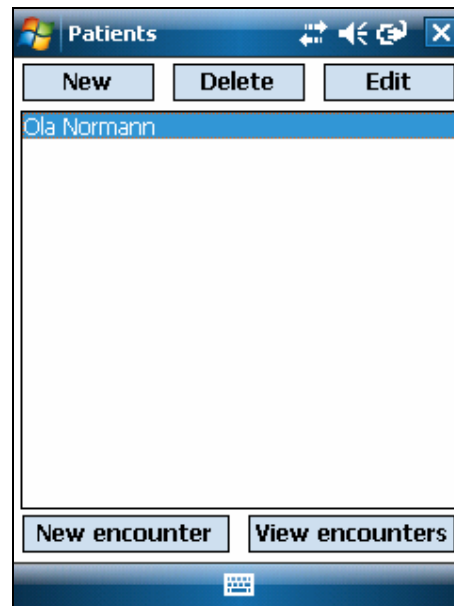

*Figure 22 List patients window*

By clicking on “New encounter”, the registration for a new encounter (see 3.5.7) on the selected patient will be started. If no patient is selected, an error message will be displayed and the clinician is informed that (s)he must select a patient to continue. If the clinician wishes to view all encounters (see 3.5.6.1) registered on the selected patient, (s)he can click on the button labeled as “View encounters”.

### 3.5.6.1 View encounters

The view encounters window (Figure 23) provides the clinician with a list of all the encounters registered on a given patient, and five buttons to perform actions on the encounters. The list shows the encounters chronologically. Each encounter is described by encounter date, the clinician who registered it and the residing hospital of the encounter.



*Figure 23 Encounters window*

If the clinician wants to alter some of the information registered in an encounter, e.g. if something was registered erroneously, (s)he can select the given encounter and click “Re-open”. (S)he will then be able to change the registered information in the same window as the encounter was registered in (see 3.5.4). The clinician can also choose to view the registered information about the encounter by clicking “View”. This procedure is similar to the case of re-opening an encounter, the only difference being that the information is read-only.

An encounter can be deleted as well. This is useful if the encounter was e.g. not registered on the correct patient, and is done by selecting the encounter and clicking “Delete”. The clinician is then prompted to confirm the deletion to avoid unintended deletes.

Treatments often happen in series. Some illnesses can recur, and it is necessary to restart the treatment. This is done by clicking “Restart treatment”. A new series of encounters is then created.

The clinician can get a list of all the treatment (Figure 24) performed on the patient by clicking “Actions”.

Re-encounter	Date	Action	New
3/16/08	3/16/08	Apply cast on right foot	Berger
3/23/08	3/23/08	Apply cast on right foot	Berger
3/30/08	3/30/08	Perform tenotomy on right foot	Berger
	3/30/08	Cast right foot for 3 weeks	
	3/30/08	Measure right foot and order orthosis	

Figure 24 List of actions

### 3.5.7 New encounter

When the clinician enters the encounter registration process, (s)he first has to choose the date on which the encounter will take place (Figure 25). Default date value is the current date, but it is possible to set this date back in time to allow registering the encounter even though the clinician did not have access to GenSupport at the time of the encounter. Which patient and guideline the encounter concerns is also displayed in this screen.

By clicking “Next”, the guideline will be processed step by step (see 3.5.8 for step types) until finished. Then the clinician is asked to provide comments on the encounter (Figure 26).

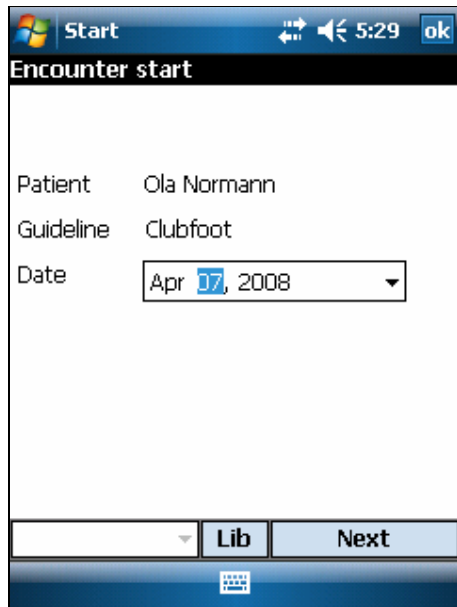

Figure 25 Encounter start

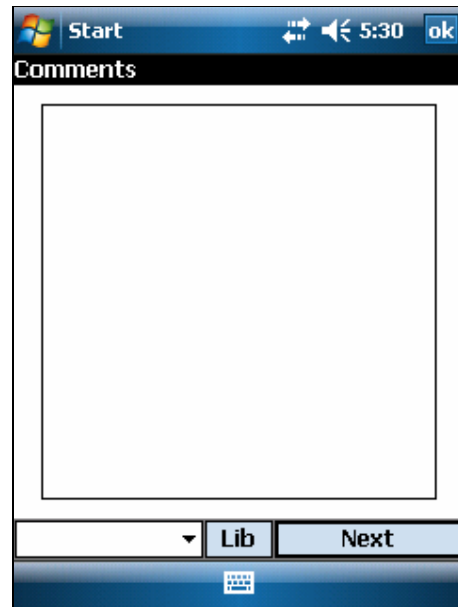

Figure 26 Comments window

### 3.5.8 Steps

All steps have their title displayed in the black bar at the top of the window (Figure 27). Controls for workflow navigation can be found at the bottom of the window.

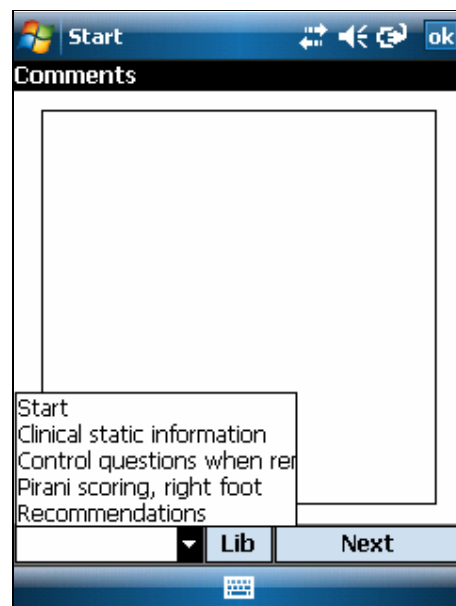

Figure 27 Step navigation

The button labeled “Next” lets the user navigate to the next step. It is also possible to skip backwards in the workflow of the guideline. The users can not skip forwards. A



list is available in each step where the user can choose which step in the workflow to skip back to. The button labeled “Lib” is intended to let the user access the guideline’s library resources, but has not been implemented yet.

### 3.5.8.1 Data form

The data form is used to display and gather information from the user. Fields marked with a red star are mandatory, and must be completed by the user before (s)he can proceed to the next step.

The screenshot shows a Windows-style window titled "Clinical static information". The window has a standard Windows taskbar at the top with "Start", system icons, and an "ok" button. The form content includes:

- \* Clubfoot type: Idiopathic clubfo (dropdown)
- Syndromic type: (dropdown)
- Neuropathic type: (dropdown)
- \* Side affected: Right (dropdown)
- Any previous clubfoot treatment?: Yes (dropdown)
- Side Treated: Righth (dropdown)
- Right side: (checkbox)
- Number of casts: 4 (text input)
- Navigation tabs: Clubfoot, Family history, Physical exam
- Buttons: Lib (highlighted), Next

Figure 28 Data form

Fields can be grouped in tabs and in field groups. This is to enhance the logical coherency of the data form.

### 3.5.8.2 Classification

The classification form allows the user to perform a classification of predefined attributes concerning the patient and/or his/her condition by selecting the values by clicking on images (Figure 29). Images are grouped according to which attribute they belong to. In this grouping there is a blue square with a question mark on. The user can click it to view the description of the attribute. A red border is added to the image selected by the user.

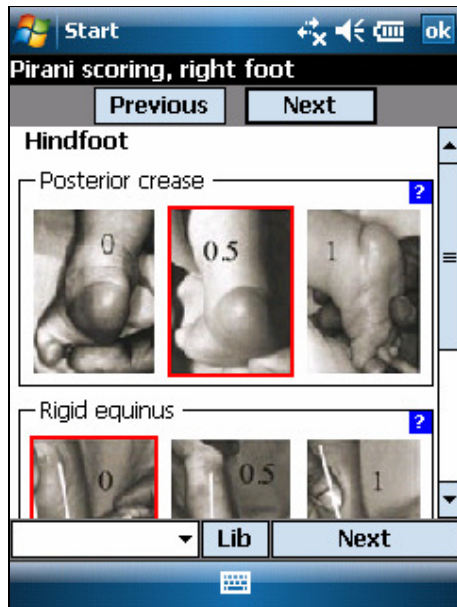

Figure 29 Classification

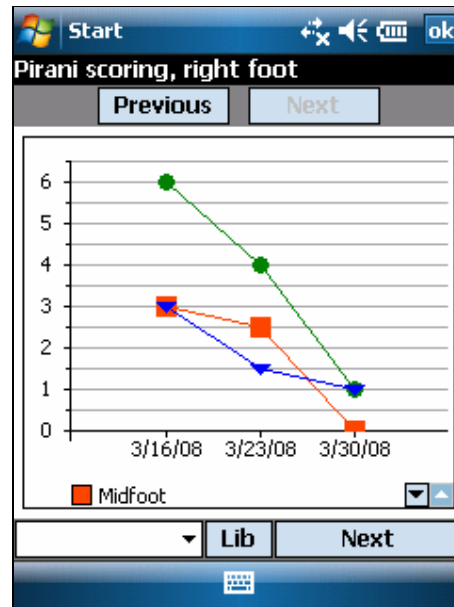

Figure 30 Graph

Classification attributes can be grouped. Each group of attributes has a dedicated page in the classification workflow. The user can navigate in this workflow by using the “Previous” and “Next” buttons located at the top of the window. When the user has completed all the attribute groups, a graph summarizing the classification is shown (Figure 30).

The graph shows a line for each attribute group, and a line for the total sum of all the groups. Encounter dates are displayed on the x-axis. The legends for the lines are displayed in a list below the graph. The user can browse the list by using the arrows to the right of it. Because of the limited screen size on the handheld computers, it has been chosen to not display all legends simultaneously.

### 3.5.8.3 Recommendation

Each recommendation module has a set of rules which is evaluated. The result of this evaluation is a set of recommendations. These are presented to the clinician (Figure 31). The clinician can also choose an action manually (Figure 32).

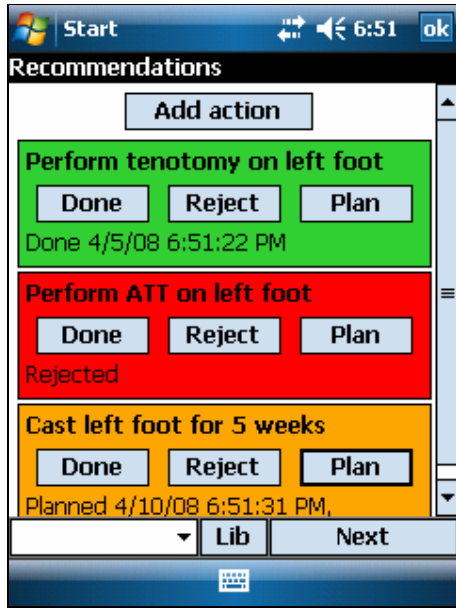

Figure 31 Recommendations window

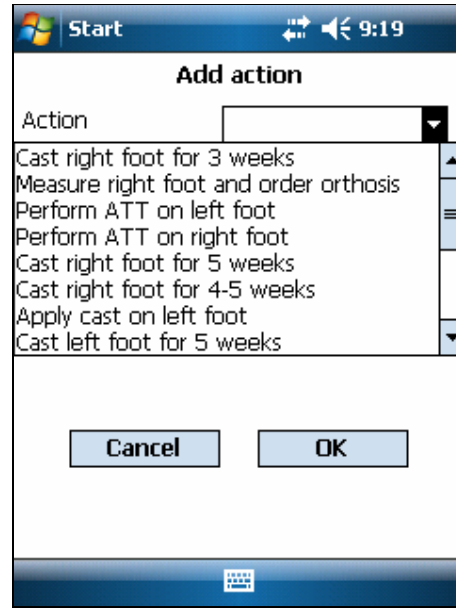

Figure 32 Add action

The clinician has to decide whether to accept the recommendations, to reject (Figure 33) or plan (Figure 34) them.

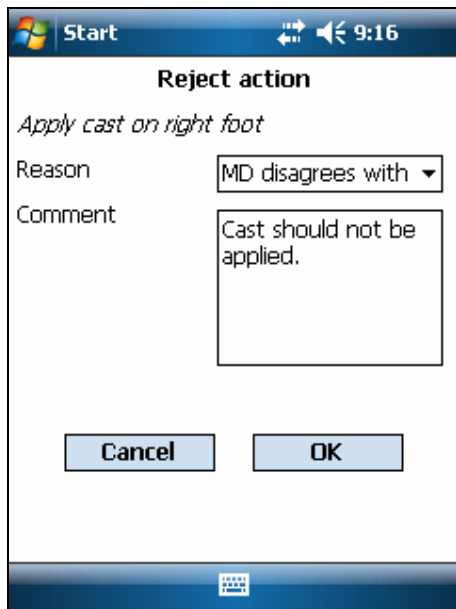

Figure 33 Reject action

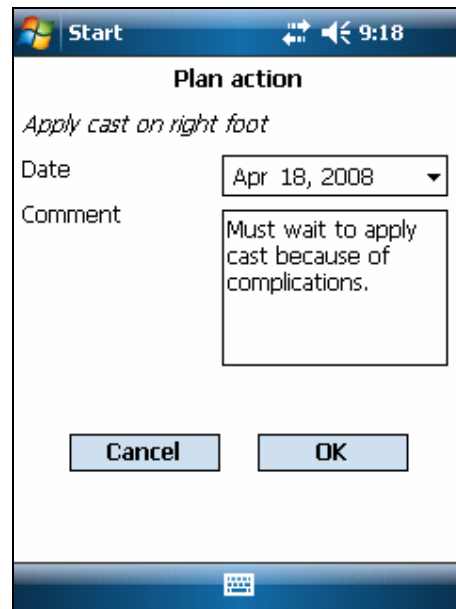

Figure 34 Plan action

# 4 Evaluation

---

The evaluation of GenSupport focuses on whether this system is able to support the treatment. First, a quantitative evaluation is conducted. The goal of this evaluation is to test the quality of the advice given by the system. There has also been a qualitative evaluation with domain experts, where the goal is to evaluate the usability and usefulness of GenSupport, in addition to identifying issues in need of improvement.

All the evaluations in this chapter were performed with GenSupport set up for the clubfoot guideline.

## ***4.1 Evaluation of the rules and rules engine***

The rules engine and the advices given by GenSupport is the main focus of this evaluation. GenSupport was quantitatively evaluated in two sessions, and actual patient data were used in the evaluations. The advice provided by GenSupport has been compared with the actual treatment provided by the clinicians. Due to the short time available for testing and the immaturity of the system, this was the most authentic way possible for testing GenSupport's ability of providing correct treatment advice. No expert domain knowledge was needed for this evaluation, thus the patient data was registered by me in GenSupport.

Data about the patient and data about his/her treatment was plotted systematically into GenSupport, just as a clinician normally would. First, the patient was registered anonymously in the system. A fictive name was assigned to each patient, and the only real information about the patients registered was the date of birth. Then, each encounter was registered chronologically. The resulting advice of each encounter was documented for later analysis.

Data from the evaluations were collected manually. The advices given by GenSupport at each encounter were documented in a grid (appendices I and J). The results of each case have been evaluated to either correct or not correct. If GenSupport has not suggested exactly the same as what has been done in a case, the case is considered not correct.

## 4.1.1 Evaluation one

### 4.1.1.1 Data source

Patient data were provided by Dr Peter Klungsøy. A data set containing single encounters of 8 patients from Black Lion hospital in Ethiopia was used. The data set contains patients having left foot, right foot or both feet affected by clubfoot. All of the patients have received treatment prior to the consultation they had with Dr Klungsøy. Due to the inadequate routines for registration and archiving of treatment data, only the data provided by Dr Klungsøy about these patients was available.

### 4.1.1.2 Results

Correct advices were provided by GenSupport in 5 of the 8 cases (Table 1). Two of the cases were not correct, because the system suggested starting using orthosis on patients already using orthosis. The last incorrect case was regarding a patient suffering from clubfoot on both feet. The patient had a right midfoot score of 1.5, and a left midfoot score of 0. According to the rules, tenotomy should then be performed on the left foot, while cast should be applied on the right foot. Though, tenotomy should not be performed until both feet have a midfoot score of 0. The rules need to be updated accordingly to correct for both incorrect cases. GenSupport provided correct advices in all cases according to the rules defined in the configuration file.

Status	Cases	
Correct	5	62.5 %
Not correct, recommended to start orthosis when already started	2	25 %
Not correct, recommended tenotomy too early	1	12.5 %
<i>Total</i>	8	100 %

*Table 1 Rules engine evaluation one test results*

Complete test results are provided in Appendix I.

### 4.1.1.3 Discussion evaluation one

The results from the first evaluation of the rules engine shows that more effort is needed to make the rules correct. More rules must be added for GenSupport to be able to cope with all variances in the treatment. The evaluation also demonstrates the

## Evaluation

importance of testing the rules thoroughly before they are ready to be used in a real setting.

According to Dr Klungsøyr, tenotomy is only performed on approximately 50 % of the patients in Ethiopia. Dr Ponseti estimates that 90 % of the patients need tenotomy. Reliable registration of treatment data would make it possible to investigate whether the need for tenotomy in Ethiopia is actually as low as 50 %, or if the procedure is not performed often enough.

### 4.1.2 Evaluation two

#### 4.1.2.1 Data source

Patient data were provided by Dr Christian Sætersdal at Haukeland hospital. A data set containing full treatment history on 17 patients having congenital clubfoot on right foot, left foot or both feet was used.

#### 4.1.2.2 Results

GenSupport provided correct advices on 5 of the 17 patients (Table 2). On the other patients, the system advised to perform the tenotomy either before or after it was actually performed.

Status	Cases	
Correct	5	29.4%
Tenotomy advised before actually performed	7	41.2%
Tenotomy advised later than actually performed	5	29.4%
<i>Total</i>	<i>17</i>	<i>100%</i>

*Table 2 Rules engine evaluation two test results*

Based on the rules available, GenSupport advised to perform tenotomy earlier than actually performed on 7 of the 17 patients, and later than actually performed on 5 of the 17 patients. All advice given was correct according to the rules provided in the configuration file. Complete test results are provided in Appendix J.

#### 4.1.2.3 Discussion evaluation two

The rules used in the second evaluation of GenSupport were provided by another orthopaedian than the one providing the patient data. There is a possibility that there

are small variances in how the different orthopaedians treat clubfoot. This can explain some of the incorrect cases in that evaluation.

According to Dr Klungsøyr, the Ponseti expert group specifically recommends to perform tenotomy as soon as the midfoot score is 0. When the clinicians are in doubt about whether the procedure should be performed, they should perform it (Staheli, 2005, p. 11). In seven of the cases investigated in the second evaluation of the rules, tenotomy was not performed according to the recommendations from the Ponseti expert group. In these cases, the rules were correct and the clinicians provided a sub-optimal treatment. Considering this, GenSupport provided correct advice in 70.6 % of the cases with the current rules.

In five of the cases, the clinicians performed tenotomy earlier than GenSupport recommended. In these cases, there is no apparent pattern describing why the clinicians have acted as they have. The clinicians' actions are most likely based on factors not documented in the patient data available in this evaluation. It is reasonable to believe that the clinicians provided what was considered to be the best care for their patients in these cases.

### **4.1.3 Summary of the evaluation of rules and rules engine**

The results from this evaluation of GenSupport show the importance of the knowledge engineering process. Small variances in the rules can influence the outcome heavily, and tuning the rules would most likely enhance the quality of the advice given by GenSupport.

The findings from this evaluation support that clinicians should take clinical decisions, not the machines (Dugas et al., 2002).

## **4.2 Evaluation with domain experts**

GenSupport configured for clubfoot treatment has been evaluated with three domain experts with focus on usability, usefulness and improvements. Usability focus on how easy the system is to use, while evaluation of usefulness is intended to establish the performance of the system within the problem domain.

## **Evaluation**

A comparison of the handheld platform and regular computers is also provided. After each domain expert's evaluation, improvements were made based on the feedback.

### **4.2.1 Evaluation design**

Qualitative evaluation methods such as think aloud, observation and semi-structured interviews were used in this part of the evaluation of GenSupport.

Evaluation has been conducted by testing the clinical decision support system created in the design and development phase with several domain experts to examine how it would work in a real setting. Ideally, the system should be tested by using it for its intended purpose in the intended environment for as long as possible, but this was not possible due to the time-constraints of the project.

First, clinicians were observed while using the system with patients who have finished the treatment to assess whether the system gives the same advice as the clinician did when treating. After finishing this phase, semi-structured interviews with the clinicians involved in the evaluation were conducted to analyze the usability and usefulness of the system. The data collected was analyzed and improvement was made based on the feedback.

It is important in an evaluation like this to look at how the users feel about the application, since it can potentially have great impact on their working environment. A system can fail because the users do not feel they benefit from using it, no matter how well designed the system is (Jones and Marsden, 2006, p. 41). Information about the users' opinions about the system has been collected during the semi-structured interviews to investigate the level of user satisfaction.

#### **4.2.1.1 Subjects**

Due to the complexity of the rules implemented in GenSupport, the evaluation required highly skilled and experienced domain experts. All the subjects in the evaluation are experienced orthopaedic physicians with many years of experience treating clubfoot.



### 4.2.1.2 Tasks

Before testing, the functions of the system were analyzed to decide which tasks should be the focus of the evaluation. Four core tasks were identified, and the test subjects were asked to perform these tasks using GenSupport:

- Register a new patient
- Find an already registered patient
- Register a new encounter
- Find an already registered encounter

These tasks cover the basic functions which GenSupport offer. In addition to these tasks, the evaluators were asked to play with the system as they wanted. It was important to allow the clinicians to free-play with the system, since this makes them more confident with the system, as well as possibly unveiling shortcomings in the system.

### 4.2.1.3 Data collection

The clinicians were asked to use the think-aloud protocol when using GenSupport. This, as well as observation, worked as a good source for data about how the system works.

A semi-structured interview was performed with each of the participants in the evaluation. The interview focused primarily on the usability of GenSupport and the usability of handheld computers. Some of the questions aimed at investigating the usefulness of handheld computers within the domain GenSupport is intended to be used in.

Several issues and errors were found during the testing of GenSupport. Issues are things that could be better or functions which could be added to the system, while errors are malfunctions in GenSupport. Fatal errors are errors interrupt the normal execution of the system and brings it to a complete halt, while non-fatal errors (simply referred to as errors) causes unwanted behavior in the system.

## **Evaluation**

All errors and issues commented or discovered during the evaluation session was thoroughly documented. All errors were taken care of before the next evaluation, while the issues were documented for later improvement of GenSupport.

The interviews and the think-aloud sessions have been audio recorded. The interviews have been transcribed, and can be found in appendices B, C and D.

### **4.2.2 Conducting the evaluation**

This section will provide information on how the evaluation was conducted. First, the participants received training on how to use GenSupport and they were also given time to try out the system by themselves. After the participants felt confident using the system, they were asked to perform a set of predefined tasks. Lastly, an interview was conducted with the participants.

GenSupport was configured before the evaluation. Clinicians, locations and the clubfoot guideline were registered in the system, thus GenSupport was properly set up and ready to use for evaluation.

#### **4.2.2.1 Training**

The clinicians participating in the evaluation had limited or no experience in using handheld computers as well as clinical decision support systems. Thus it was necessary to provide proper training to enable them to utilize GenSupport correctly.

Even though GenSupport has been developed with the purpose of being easy to use, some elements in the user interface might be unfamiliar for an inexperienced user. Training the participants of an evaluation before letting them use the system at their own was therefore important and enhances the validity of the results.

All the functions in GenSupport were explained in a walk-through of the system. The clinicians were encouraged to ask questions when there were doubts about how something worked.

### 4.2.2.2 Evaluation setting

The evaluation sessions was done on-site at the offices of the respective clinicians. This was necessary to be able to access the experts needed. This would also be the most realistic environments available for testing the system.

Each clinician conducted the evaluation separately. The evaluation with clinicians had a dual purpose, both validating the knowledge contained in the system as well as evaluation the usability of it. The clinicians were allowed the time needed to perform an in-depth evaluation of GenSupport.

GenSupport was run on a handheld computer in the evaluation to make the environment as authentic as possible. The handheld computer was connected to a laptop to allow analysis of system errors during evaluation. When a fatal error occurs in a program running on a handheld computer, the operating system does not provide an error message accurate enough for identifying the error. Thus, the program was executed from the laptop, running the development environment in debug-mode. This provides proper error messages, and makes it easier to find the source of the error.

Errors in GenSupport were found in all the evaluations, and these were corrected before the next evaluation session.

### 4.2.3 Findings

The findings from the evaluations are presented in this section. Because GenSupport has been evaluated with only 3 domain experts, each evaluation session is presented alone. All citations have been translated from Norwegian (original transcriptions can be found in appendices B, C and D).

#### 4.2.3.1 Evaluation one

The first evaluation was conducted with the initiator of GenSupport, Dr Klungsøyr, head surgeon at Ålesund hospital. This session worked both as an evaluation and as a pre-acceptance test of GenSupport.

Before starting the evaluation, the rules made in the knowledge engineering process were examined to ensure the validity of the recommendations which the system is

## **Evaluation**

able to provide. Some minor adjustments to the rule set were made before the evaluation of the system.

### ***4.2.3.1.1 User interface and usability***

The participant was generally satisfied with GenSupport, and believed that the system was easy to use. He also believes that by using GenSupport, the registration of data would be more reliable and efficient than it is at present, with paper forms and scarce routines for archiving.

Because this was the first evaluation of the system, quite a few errors and issues were discovered. 28 issues and 6 fatal system errors were discovered in this evaluation.

Some of the issues were concerning the graph component in GenSupport. The participant said that yellow should not be used as a line colour in the graph, because the contrast between the yellow line and the white background was quite poor.

Another problem emphasized in the graph component was a problem which occurs when a node in the graph is on top of another node. Then it is not possible to see the under-laying node.

The participant also said that he felt it was inconvenient to navigate backwards in the workflow of GenSupport by using a drop-down menu.

Handheld computers do not have a physical keyboard as a regular computer has. User input is done by using a soft keyboard on the screen of the handheld computer. Due to the limited screen size of the device, the soft keyboard is only shown on the screen when needed. The user of the handheld computer displays the soft keyboard by clicking on a button on the screen of the device, and then the soft keyboard is expanded. When expanded, the soft keyboard covers approximately one third of the device's screen. The participant said that he felt this soft keyboard often obstructed the navigational buttons in GenSupport. This can be solved by moving the navigational buttons when the soft keyboard is expanded, but has not been done because some compromises have to be made with such a limited screen size.

The participant identified a need for GenSupport to allow the user to manually set the date of the encounter.

*“It is necessary to register the date of the encounter (...) to have the opportunity of registering treatments in retrospect if the system did not work or if something was wrong. (...) But then you are not certain if the dates are registered fictitiously. This reduces the dependability if it is possible to set the date for a registration.”*

It is important to allow the users of GenSupport to perform the registration in a convenient manner, even though this could jeopardize the dependability of the registered data. Allowing the users to choose the date of the treatment could weaken the dependability of the registered data, e.g. when the registration is a part of a study. Some might be interested in altering treatment dates to benefit a given outcome of the study. Though, the users of a clinical decision support system are usually highly trusted persons and it should be reasonable to expect that they do not register fictitious data.

In addition to ability to registering the date of the encounter, it was also suggested that the date of the treatment should be displayed in the graph which visualizes the treatment progression.

The participant considered the main asset of the system to be the possibility of registering patient information and the Pirani score. There was at the time of the evaluation about 500 clubfoot patients at the Black Lion Hospital in Ethiopia, where he works regularly. Due to the lack of routines, the current registrations there are not reliable. Data is usually registered on paper forms, and the archiving is inadequate and not computer-supported. He claims that *“by using this system one is forced to carry out the registration at the moment”*, and that reliable data are more important than the recommendations which GenSupport is able to provide.

When asked if he believes that GenSupport could make him more efficient as a clinician, the participant replied the following:

## Evaluation

*“The registration would be more efficient; (...) it would be a lot more reliable and efficient. When it comes to the treatment, it depends on how experienced one is. Those who are experienced know how to do the treatment. But it takes a long time to get experienced (...), for those who have few patients, and who have just started learning this would be very helpful. (...) Through a decision support system, an experienced person can convey his/her knowledge to others.”*

The participant believed that, in the case of clubfoot treatment, GenSupport would be best suited for those who are less experienced, since those who are experienced knows the treatment procedures very well. Experienced orthopaedians knows how to best treat the clubfoot, and do not have the need for a decision support system. Novice clinicians on the other hand, can benefit from using GenSupport in their learning period. Clinical decision support systems have been proved to improve clinical decision making (Friedman et al., 1999). Clinical decision support systems are well suited for support training of novices (Friedman et al., 1999).

The participant plans to use GenSupport in Ethiopia. An issue discovered during evaluation is the difference between the western calendar and the Ethiopian calendar. Before GenSupport can be used in Ethiopia, it has to be compatible with the Ethiopian calendar.

It was also suggested that the clinicians should be able to schedule new appointments with GenSupport and use the system to follow up these appointments. GenSupport is currently able to give recommendations to the clinicians about what to do. The clinicians can plan when they want to perform the recommended actions, but currently there is no solution for following up these plans. Scheduling functionalities would make GenSupport more complete as a clinical tool.

### ***4.2.3.1.2 Comparing platforms***

The participant had no difficulties using a handheld computer. *“I am not used to handheld computers], but I do not have any problems using it”*. Both his statements in the interview and the observation confirmed that he used the handheld computer with ease, even though he had little prior experience with this type of computers. He

experienced no problems neither when reading nor when writing on the screen of the handheld computer.

A handheld computer was considered to have advantage over a regular computer:

*“(...) you can keep the handheld computer in your pocket when working with the patient (...)”*

He emphasized that a handheld computer is easier to use and transport in a hectic clinical environment. He often works in several rooms, and appreciates the mobility of the handheld computer. Also, he pointed out that the handheld computers are more robust than a regular computer. They are more robust and resistant to dust and shock. Another advantage which he emphasized is the quick start-up time of the handheld computers, compared to a regular computer. While regular computers often need several minutes before being ready to use, handheld computers are ready almost instantaneously. The time saved can in some cases be both precious and valuable in a hectic environment.

### ***4.2.3.1.3 Improvement before the next evaluation***

All the fatal system errors unveiled in this evaluation was taken care of before starting the next evaluation. In addition, several issues were also dealt with. Most of these concerned the graph component in GenSupport.

Yellow was removed from the graph component's line colour pool; because it was discovered in the evaluation that the contrast between the thin yellow line and the white background of the graph was quite poor.

The problem regarding readability when nodes in the graph are overlapping was solved by using a unique shape for each of the lines nodes, instead of all lines having circular nodes.

In addition, date was added as legend on the x-axis in the graph to enhance the information provided in the graph.

## Evaluation

### 4.2.3.2 Evaluation two

The second evaluation was conducted with a specialist in orthopaedic surgery at Haukeland hospital in Bergen.

#### 4.2.3.2.1 *User interface and usability*

Since a lot of the issues and errors in GenSupport were fixed before the second evaluation was conducted, the amount of issues and errors was significantly reduced from the first evaluation. Only 3 issues and 2 system errors were found in the second evaluation, none fatal. The participant was satisfied with GenSupport, and believed it was generally easy to use.

The participant commented that it would be more convenient if the cursor was automatically placed in the first text field on the screen after the soft keyboard had been extended. Then he would be able to start writing at once, instead of first setting the cursor to the right field before starting to write.

The participant believed it was easy to retrieve stored patients in the system, though he commented that it could be harder to retrieve patients registered in the system when the mass of patients registered gets substantial, due to the simplified facilities for searching for patients in GenSupport. Sophisticated search functionality would solve this problem, but has not been implemented due to time-restrictions in the project.

Due to his level of experience, the participant did not believe he could benefit from using GenSupport apart from as a tool for registering patient data alone. Although, he believed the system could be useful for clinicians who have little training in treating clubfoot.

*“I believe that in an environment where there are inexperienced nurses, physiotherapist or physicians who are going to treat a lot of patients, [GenSupport] can be useful in the beginning (...).”*



The participant considered the system most valuable as a training aid, a tool for the clinicians to enter the routine of the treatment. Those using the system could then follow the recommendations given by the system during treatment.

He also responded that even though the clinicians are supposed to register the Pirani score of the clubfoot at each encounter, this is often neglected due to the high pace in the environment they work in. During the evaluation, patient journals containing information about clubfoot treatment were used as a source for test data for the evaluation, and several of these journals had insufficient information, e.g. Pirani score was not registered consequently.

This participant suggested that it should be possible to register encounters in a broken time-line, i.e. register the encounters in non-chronological sequence. This would make GenSupport more flexible for the user, but also more complex because all available treatment information is used to provide advice on how to proceed with the treatment. If the foundation of these recommendations changes, the recommendations made could be void. This implies that it is not feasible to allow the users to register the encounters in non-chronological sequence.

The participant also thought that the paper forms which they use today (Appendix H) offered a better summary of the patient's treatment. He believed that it is very easy to get an overview of the patient's condition when looking at the tabular presentation of data about the clubfoot condition.

### ***4.2.3.2.2 Comparing platforms***

The participant had no difficulties using the handheld computer; this was documented both through observation and through the interview:

*“It is easy. (...) I have not used a [handheld computer] before.”*

He became familiar with the user interface of the handheld computer very quickly. Both reading and text input on the handheld computer were no problems to this participant. He claimed that he would prefer a laptop in stead of a handheld computer, because that is what he is used to.

## **Evaluation**

When treating clubfoot, this participant is usually in the same room all the time. The room has a desktop computer, on which he can access the electronic patient journal.

### ***4.2.3.2.3 Improvement before the next evaluation***

Both the system errors found in this evaluation were fixed before the next evaluation. The first error was in the graph component. The data about the current treatment were displayed twice in the graph when re-opening the treatment. The other error concerned the computations in the rules engine. Current date was always used when calculating the age of the patients, and not the date selected by the user. The system was changed, such that the correct date is used when calculating dates.

### **4.2.3.3 Evaluation three**

The third evaluation was conducted with a head physician in pediatric orthopaedics at Haukeland hospital in Bergen.

#### ***4.2.3.3.1 User interface and usability***

As expected, the amount of errors and issues on this evaluation was lower than on the first evaluation. One fatal system error occurred, and 5 issues were identified. Some of these issues have been identified in the previous evaluations.

The participant was generally satisfied with GenSupport. He believed it was both simple to use and user friendly. He had no problems or difficulties registering information on the handheld computer, even though he had no prior experience with such devices. This was established both in the observation and in the interview.

One of the main assets of GenSupport is the ability of classifying attributes of the patient's condition by selecting values for the attributes by clicking on images representing the values. This was emphasized by the participant as what he considered as one of the best qualities of the system:

*"...The Pirani scoring was very good and pedagogically, nice that you can click [on images] in stead of typing in numbers."*

The participant believed that GenSupport would function very well in the ordinary cases of clubfoot, but had doubts about the usefulness of the system when using it to support treatment of complex cases of clubfoot. *“It’s not easy to cover all eventualities”* according to the participant. This is though a challenge in the knowledge engineering process to make the configuration of GenSupport to cover all eventualities, and not a problem with the GenSupport framework. Given that the knowledge engineering process is sufficiently thorough, it should be possible to cover the complex cases of clubfoot as well.

The participant stated that he would not use GenSupport as a tool to support his work as a clinician:

*“I would not use it to get recommendations in the treatment I provide, because I feel that when you know how to do it, it is easy.”*

Although, he believed that GenSupport could be a useful tool for registration of patient data. He would like to use it as a patient database, to register information in e.g. research projects. *“It would be useful to do the registration in a convenient manner”*. He appreciated the functionality GenSupport has for easy data registration.

The soft keyboard issue was also pointed out by this participant. Several times he had problems finding elements in the user interface because these were concealed by the soft keyboard. Some guidance was provided on how to proceed when this happened. The participant did not find the behavior of the soft keyboard intuitive, and stressed this as a negative factor in the user interface in GenSupport.

The participant would also like to customize the configuration and make the registration simpler by removing all information not interesting for him. He believe it is important to focus on what is important for himself, and to remove the elements aimed at making the configuration useful for as many as possible. This can easily be done since all domain-specific knowledge in GenSupport is kept in a separate configuration file (see 3.4.3).

## **Evaluation**

### ***4.2.3.3.2 Comparing platforms***

The participant preferred the handheld platform to regular computers in this case. He believed handheld computers are easier to transport, e.g. between work and home, and between rooms at the hospital. He emphasized that there is a lot of equipment in the polyclinic taking up space, and that the handheld computer could enter that environment without requiring much space.

When treating patients the participant often move between several rooms. The rooms are usually equipped with desktop computers. The clinicians are logged on to all of these computers simultaneously, occupying several computers at once. The participant believed that it would be possible to run GenSupport on these computers, as he already uses them. Though, he believed that handheld computers would be useful in environments where the infrastructure is not as well built as on Haukeland hospital.

### ***4.2.3.3.3 Improvement after the last evaluation***

The fatal system error discovered in this evaluation concerned the login functionality. When the user tried to log in without providing a username or a password, the system would crash because of an exception occurring in the communication with the database. The problem was corrected.

## **4.2.4 Summary and discussion**

This section summarizes on the results of the evaluation. The evaluations are analyzed as a unit, and some of the findings from the analysis suggested topics in need of improvement and more research.

### **4.2.4.1 User interface and usability**

All the clinicians participating in the evaluation were generally satisfied about GenSupport. This is supported by the interviews. They also had suggestions on how the system could be improved. The participants of the evaluation agreed on some of the improvements that were suggested, but they also had different views on what could be improved in GenSupport, this is most likely because of personal preferences, differences in where and how they perform their work and previous experiences.

The clinicians had the same opinion about whether they believed they could benefit from using the system. Due to their high level of expertise, they did not believe they could benefit from getting treatment advice from this clinical decision support system. Two of the participants believed that GenSupport would be best suited as a tool for training novice clinicians, while the third implied this by saying that he felt the system was not necessary because of his level of competence. Dr Klungsøyr commented that a decision support system is a good way to allow an experienced person to transfer his/her knowledge to less experienced persons. Clinicians are highly educated professionals, and they have thorough training in the procedures they perform. A clinical decision support system might thus not be of much help to clinicians who have finished training, especially when the treatment procedure is easy to understand. However, decision making often becomes more complicated when the decision depends on many different variables, and then skilled clinicians might also benefit from a tool like GenSupport when the condition is more complex than in this evaluation.

All the clinicians identified an area which GenSupport could help improving; the current routines of registration and archiving data about the treatment. They stated that these routines currently do not work as supposed to, and that they often experienced that treatment data are not registered as it should be. Treatment data are registered insufficiently, or not at all. This problem in Norway is most likely caused by the hectic environment in which the clinicians work, since electronic medical records are used as a standard at all hospitals. In Ethiopia, where Dr Klungsøyr has been working, the problem is most likely caused by a lack of computerized routines for archiving treatment data. In either situation, GenSupport can help to improve the registration by “forcing” the clinicians to register proper treatment data while treating the patient.

### **4.2.4.2 Comparing platforms**

None of the participants in the evaluation had difficulties using the handheld computer. The soft keyboard which the users of the handheld computers can utilize to input text can be difficult for regular users to get used to, since using it requires a high level of precision. Observation showed that the participants in the evaluation had no problems at all using the soft keyboard, even though they were not used to a user

## **Evaluation**

interface like this. This is most likely because the participants in the evaluation are skilled and experienced surgeons, who have extensive training in tasks requiring high precision.

Although having no problems using the soft keyboard, all clinicians commented on the usability of it. Because of the limited screen size, the soft keyboard often hides elements in the graphical user interface when expanded. This trade off in the design of the user interface of the handheld is hard to by-pass, as long as one is limited to a small screen and text input on the same screen as information is displayed on. However, the user interface should be re-designed to avoid the soft keyboard hiding elements in the graphical user interface when expanded. The correct action should always be visible to the user when it is going to be used (Dix et al., 2004, p. 321).

There was no consensus amongst the clinicians participating in the evaluation on what kind of platform is best suited for GenSupport. One was very positive about handheld computers, while another believed regular computers were best suited. The third believed that both kinds of computers could be feasible to use for the purpose.

### **Pro handheld computer**

- Robust design, more resistant to dust and shock than a regular computer
- Easy to transport and stow away
- Quick start-up time

### **Pro regular computer**

- Familiar user interface
- Most doctors have access to a computer in their treatment environment

The only conclusion possible to make about the platform is that personal preferences strongly influences which platform each clinician believes is best suited for the job. Local infrastructure would also make implications on which platform is best suited. Handheld computers would without a doubt be preferable in locations lacking basic infrastructure such as electricity and network access.

### 4.2.4.3 Reflecting on the evaluation

Since the project has followed a user-centered approach, the evaluation has been a phase in overall development process. Some of the participants in the project have had several roles. I have doubled as a developer and a knowledge engineer, while Dr Klungsøyr has been both the domain expert and the target user in the project.

It is almost impossible for developers to unveil all errors in a system by performing unit/component testing (Sommerville, 2007, p. 538). Therefore it is important for domain experts to test the rules and for target users to evaluate the system. When the clinicians evaluated GenSupport, they used it in a different manner than in the unit testing. This different pattern of use unveiled several system errors. In addition, because the clinicians focus on the usability of the system, their feedback is crucial for the improvement of the system.

This short time available has affected the quality of the evaluation of the clinical decision support system because “*measuring its impact is complex thus a long-term evaluation strategy is required*” (Coiera, 2003, p. 339). Although clinical decision support systems, and computer systems generally, should be tested and evaluated for as long time as possible, this is rarely done (Coiera, 2003, p. 339). Given more time and more domain experts it could be feasible to apply quantitative methods to evaluate the usability of GenSupport. Several measures could then be established for the evaluation process. Treatment time, treatment cost as well as treatment results can be used to study the effect of the system.

### 5 Conclusion and future work

---

The goals of this thesis are to investigate how a CDSS supporting the treatment of clubfoot can be developed, and to evaluate whether such a system can improve the treatment.

A CDSS called GenSupport was developed in collaboration with Dr Klungsøyr. Initially, the system was intended to support clubfoot treatment only, later GenSupport was developed as a generic CDSS. All domain-specific knowledge was separated from other components of the system. Although, the main focus throughout the project has been to support the treatment of clubfoot, it would be easy to replace the clubfoot treatment knowledge with knowledge for treating other conditions or illnesses.

The project was conducted as a design research project. The GenSupport CDSS was developed iteratively, following a user-centered approach. Requirements for the system were clarified by using a mock-up, and an incremental prototyping method was used.

Evaluation of the system was conducted with three domain experts. Qualitative methods such as think aloud, observation and semi-structured interviews were used in the evaluation. Based on the feedback from each of the participants, the prototype of GenSupport was improved between the evaluations.

The evaluation established that GenSupport is able to improve the routines around the treatment of clubfoot. All the participants in the evaluation emphasized that GenSupport would simplify the registration of patient and treatment data. GenSupport was also suggested as a good learning tool for medical students.

Ethical issues need to be considered, since the application can influence the treatment of patients directly. Even though GenSupport can provide treatment advice, it is important that the clinicians using the system make the final decision on which treatment to provide for their patients.



### **5.1 Future work**

Based on the feedback from the evaluations, some possible improvements to GenSupport have been identified. Some of these improvements are necessary before GenSupport can be used by clinicians in their practice.

#### **5.1.1 Infrastructure**

If GenSupport is to be used in an environment with several users of the system, it should be developed into a client-server structure. All information should then be stored in a centralized database, and then all users would have access to the same information. Currently GenSupport runs an embedded database. This makes the process of migrating to a client-server structure rather trivial. GenSupport would then be synchronized with a centralized database, and the embedded database would work as a local cache.

Electronic medical records where patient information is already stored should be integrated with GenSupport. It is inefficient for the users to register information in GenSupport, when this information is already registered in another system. Double registrations are prone to error, and it is resource-demanding to update several information systems simultaneously with the same information.

For security reasons, GenSupport should support access control based on user privileges. It has been identified a need to be able to specify which guidelines the user can access, and at which hospitals the user is allowed to register and access patient information. Currently, the registered users are allowed to access all the information available in GenSupport.

To prevent loss of data, GenSupport should implement routines for secure delete and update. This can be achieved in the database layer by adding a column to each table where rows can be set outdated/deleted rather than actually deleting and overwriting them. No data will then be lost, and a complete revision history of the information stored in GenSupport will be kept. This solution will not be noticeable to the users of GenSupport, and it will make data recovery an easy process for the administrators of the system.

## **Conclusion and future work**

### **5.1.2 General improvements**

One of the participants in the evaluation identified the need for advanced searching facilities in GenSupport. Currently, it is only possible to perform a search for patients based on first name and family name. This can make retrieving patients difficult when the mass of registered patients becomes substantial. Especially when the user does not remember the name of the patient (s)he is looking for, it would be convenient to be able to filter the search by using e.g. gender, age or address.

All participants in the evaluation commented about the soft keyboard, mostly regarding that the keyboard hides elements of the user interface when it is expanded. This calls for a re-design of the user interface. When the soft keyboard is expanded, the area in the interface covered by it should be shrunk accordingly.

Grouping of guidelines in the main menu can make the navigation easier when there are many guidelines to choose from. The user would then have to choose which group of guidelines (s)he is interested in, before being able to select the guideline. Guidelines could be grouped by e.g. department, field or other. This enhancement would be necessary if GenSupport were to support treatments on all departments of a hospital.

One of the participants in the evaluation suggested that there was too much irrelevant information in the data form steps (see 3.5.8.1). Some information is only relevant in specific cases, thus a precondition could be used to provide the possibility of having situation-specific attributes.

#### **5.1.2.1 Classification**

The classification step could be made more flexible by allowing the user to provide a numeric-valued attribute where the user enters a number, e.g. weight or height in cm, or fixed literal values chosen from predefined lists. All attributes which information is non-numeric would then be summarized in a table in the summary of the classification.

### 5.1.2.2 Planning

GenSupport allows its users to plan for treatment to be performed in the future; however there is no functionality for following up the planned treatment. This issue can be solved by prompting the user the first time the patient is active after the time the treatment was planned to be performed, and ask whether the treatment has been performed as planned.

By adding functionality for scheduling encounters, GenSupport would become a full-functional electronic medical record system as well as a clinical decision support system.

### 5.1.3 Library resources

A CDSS can provide decision support to its users by providing relevant literature when needed. This can be done on guideline-level, by defining a set of library resources general for all the steps in the guideline. This could be e.g. treatment manuals, written guidelines or e-books providing more information about the condition which the guideline supports. It could also be practical to define library resources for each step in the guideline. The library resources could be provided to the user when pressing the button labeled “Lib” in the encounter window (Figure 27).

### 5.1.4 Explanation

To enhance the user’s confidence in the system, an explanation subsystem should be added to GenSupport. It is important to “*provide evidence and rationales supporting any clinical recommendations*” (Osheroff et al., 2005, p. 72). The explanation subsystem would then allow the users to see which rules fired to give the recommendations.

### 5.1.5 Domain knowledge editor

GenSupport is currently configured with a XML configuration file. This file can be created and edited with any editor supporting XML files. Editing the configuration file this way requires much from the knowledge engineer. A specialized knowledge base editor would be preferable as an interface for configuring GenSupport. Such an editor would support the knowledge engineering process. It can “assist in the addition

## **Conclusion and future work**

of new knowledge, help maintain correct rule syntax, and perform consistency checks on the updated knowledge base” (Luger and Stubblefield, 1997, p. 211).

## 6 References

---

- Berner, E. S. (1999). *Clinical decision support systems: Theory and practice*. New York: Springer.
- Berner, E. S. (2007). *Clinical decision support systems: Theory and practice*. (2<sup>nd</sup> ed). New York: Springer.
- Buchanan, B., & Shortliffe, E. (1984). *Rule-Based Expert Systems: The MYCIN Experiments of the Stanford Heuristic Programming Project*. Reading, Mass. : Addison-Wesley. Retrieved May 11th, 2008, from <http://www.aaai.org/Classic/Buchanan/buchanan.html>
- Coiera, E. (2003). *Guide to health informatics* (2<sup>nd</sup> ed). London: Arnold.
- Dix, A., Finlay, J., Abowd, G. D. & Beale, R. (2004). *Human-computer interaction* (3<sup>rd</sup> ed.). Upper Saddle River, NJ: Pearson.
- Dugas, M., Schauer, R., Volk, A., & Rau, H. (2002). Interactive decision support in hepatic surgery. *BMC Medical Informatics and Decision Making* 2(5). Retrieved may 8th, 2008, from <http://www.biomedcentral.com/1472-6947/2/5>
- Embi, P. J. (2001). Information at hand: Using handheld computers in medicine. *Cleveland Clinic Journal of Medicine*, 68(10), 840-853.
- Friedman C. P., Elstein A. S., Wolf F. M., Murphy G. C., Franz T. M., Heckerling P. S., et al. (1999). Enhancement of clinicians' diagnostic reasoning by computer-based consultation. A multisite study of 2 systems. *Journal of the American Medical Association*, 282(19), 1851–6.
- Gulliksen, J., Göransson, B., Boivie, I., Blomkvist, S., Persson, J., & Cajander, Å. (2003). Key principles for user-centred systems design. *Behaviour & Information Technology*, 22(6), 397-409.
- Haux, R., Ammenwerth, E., Herzog, W., & Knap, P. (2002). Health care in the information society. A prognosis for the year 2013. *International Journal of Medical Informatics* 66, 3-21.
- Hevner, A.R., March, S. T., & Park, J. (2004). Design Science in Information Systems Research. *MIS Quarterly*, 28(1), 75-105.
- Jones, M., & Marsden, G. (2006). *Mobile interaction design*. Chichester: Wiley.
- Kawamoto K., Houlihan C. A, Balas, E. A., & Lobach D. F. (2005). Improving clinical practice using clinical decision support systems: a systematic review of trials to identify features critical to success. *British Medical Journal*, 330, 765-768.
- Kendal, S. L., & Creen, M. (2007). *An Introduction to Knowledge Engineering*. London: Springer-Verlag London Limited.

## References

- Lu, Y., Xiao, Y., Sears, A., & Jacko, J. A. (2005) A review and a framework of handheld computer adoption in healthcare. *International Journal of Medical Informatics*, 74(5) 409-422.
- Luger, G. F., & Stubblefield, W. A. (1997). *Artificial intelligence: Structures and strategies for complex problem solving* (3<sup>rd</sup> ed). Harlow: Addison Wesley Longman.
- MedlinePlus Medical Encyclopedia: Clubfoot. Retrieved March 20, 2007, from <http://www.nlm.nih.gov/medlineplus/ency/article/001228.htm>
- Miller, R.A. (1996). Evaluating evaluations of medical diagnostic systems. *Journal of the American Medical Informatics Association* 3, 429-431.
- Nilsson, N. J. (1998). *Artificial intelligence: A new synthesis*. San Francisco, California: Morgan Kaufmann.
- Passer, M. W., & Smith, R. E. (2001). *Psychology: Frontiers and applications*. Boston: McGraw-Hill.
- Russel, S. J., & Norvig, P. (2003). *Artificial intelligence: A modern approach* (2<sup>nd</sup> ed). Upper Saddle River, N.J.: Prentice-Hall.
- Siau, K., & Shen, Z. (2006). Mobile healthcare informatics. *Informatics for Health and Social Care*, 31(2), 89-99.
- Shiffman, R. N., Karras, B. T., Agrawal, A., Chen, R. Marenco, L., & Nath, S. (2000). GEM: A proposal for a more comprehensive guideline document model using xml. *Journal of the American Medical Informatics Association* 7, 488-498.
- Sommerville, I. (2007). *Software Engineering* (8<sup>th</sup> ed.). Harlow: Addison-Wesley.
- Staheli, L. (2005). *Clubfoot: Ponseti Management* (2<sup>nd</sup> ed). Retrieved March 20, 2007, from [http://www.global-help.org/publications/books/help\\_cfponseti.pdf](http://www.global-help.org/publications/books/help_cfponseti.pdf)
- Tu, S. W., & Musen, M. A. (2000). From Guideline Modeling to Guideline Execution: Defining Guideline-Based Decision-Support Services. *Proc AMIA Symp. Los Angeles, USA*, 863-867.
- Tu, S. W., Campbell, J. R., Glasgow, J., Nyman, M. A., McClure, R. McClay, J. et al. (2007). The SAGE guideline model: Achievements and overview. *Journal of the American Medical Informatics Association* 14(5), 589-598.
- Turner, P., Milne, G., Kubitscheck, M., Penman I., & Turner, S. (2005). Implementing a wireless network of PDAs in a hospital setting. *Personal Ubiquitous Computing* 9(4), 209-217.

## References

Wyatt J. C., & Spiegelhalter D. (1991). Field trials of medical decision aids: potential problems and solutions. *Proc 15th Annu Symp Comput Appl Med Care 1991*, 3-7.

Zupan, B., Porenta, A., Vidmar, G., Aoki, N., Bratko, I., & Beck, J. R. (2000). Decisions at hand: A decision support system on handhelds. Retrieved May 8th, 2008, from <http://magix.fri.uni-lj.si/blaz/papers/MEDINFO-2001.pdf>

## **APPENDIX A – Interview guide**

---

1. Hvor enkelt vil du si at det er å:
  - Registrere ny pasient
  - Gjenfinne registrert pasient
  - Registrere ny konsultasjon
  - Gjenfinne og se på en allerede lagret konsultasjon
2. Hvordan var det å registrere informasjon på den håndholdte pc-en?
3. Hvordan var det å vise informasjon på den håndholdte pc-en?
4. Er en håndholdt pc mer egnet enn en vanlig pc til dette formålet?
5. Oppfyller systemet dine behov som lege?
6. Vil dette programmet kunne gjøre deg mer effektiv som lege?
7. Er det noe som kan eller bør forbedres i programmet?



## APPENDIX B – Transcription of interview 1

---

### 1. Hvor enkelt vil du si at det er å:

- Registrere ny pasient

(...) Hvis systemet fungerer og er stabilt, så virker det helt greit det altså. (...)

- Gjenfinne registrert pasient

Det gikk veldig fint.

- Registrere ny konsultasjon

(...) Du må ha en datoregistrering. Hvis du skal legge inn opplysninger i ettertid så må du ha en datoregistrering. Men ideelt sett så skal jo denne registreringen skje der og da, og ikke i ettertid. Og til det formålet så er jo dette greit nok, for da skjer jo registreringen av dato automatisk. Så det er egentlig bare for å ha muligheten av å kunne legge inn ekstra registreringer [hvis] systemet ikke fungerte eller det var noe feil. At du da allikevel kan legge inn det i ettertid. Men så er problemet da at du må jo samtidig ha en sikkerhet for at de datoene som blir lagt inn ikke blir lagt inn fiktivt. (...)

Det reduserer sikkerheten for det med å kunne legge inn dato for registreringer.

- Gjenfinne og se på en allerede lagret konsultasjon

(...) Det var greit det. (...)

### 2. Hvordan var det å registrere informasjon på den håndholdte pc-en?

Det synes jeg var greit.

- Det er jo et lite tastatur på skjermen til den håndholdte pc-en?

Det var ingen problem. (...) Jeg er jo ikke vant til [å bruke en håndholdt pc], men jeg synes ikke det var noe problem.

### 3. Hvordan var det å vise informasjon på den håndholdte pc-en?

Det var ikke for lite, jeg synes det er grei størrelse [på skriften].

- Hva synes du om mengden informasjon presentert på skjermen, man må jo ofte bla nedover for å få se alt?

Det ville nok kanskje være lettere hvis (...) du hadde sluppet å skyve [skjerm]bildet opp og ned, det hadde blitt raskere. (...) Hvis [alt] (...) hadde vært på ett [skjerm]bilde som du slapp å gå opp og ned på (...) så ville registreringen skje raskere. (...)

#### **4. Er en håndholdt pc mer egnet enn en vanlig pc til dette formålet?**

*Ja, det synes jeg absolutt for en håndholdt pc kan du ha i lomma når du arbeider med pasienten så det synes jeg absolutt må være en stor fordel.*

- **Så det å bruke en bærbar pc f.eks. hadde ikke vært like egnet?**

*Mye mer utsatt for støv, og du må ha en plass å legge den fra deg. [Den håndholdte pc-en] kan du bare legge i lomma. [En håndholdt pc] synes jeg er absolutt ideelt, gjør logistikken mye lettere.*

- **Beveger du deg mellom forskjellige rom når du behandler?**

*Det kan du gjerne gjøre ja. [I tillegg] er den rask å logge seg på, slipper å vente på at den skal [starte], det går raskt å få den opp å gå. En pc må du gjerne vente (...) 2-3 minutter på, og det er alt for dyrebar tid. (...)*

#### **5. Oppfyller systemet dine behov som lege?**

*Det vet jeg ikke, men det er (...) et godt startpunkt. Spesielt det at du får gode registreringer av (...) Pirani, det er på en måte det viktigste for å få en god registrering (...). På Black Lion [Hospital – Etiopia] er det nå over 500 pasienter [med klumpfot], og det er et reint virrvarr. Registreringene er fullstendig upålitelige. Hvis du hadde brukt [programmet] og lagt inn med en gang, så ville det, selv om man ikke hadde fått recommendations, vært masse oppnådd bare med å få en enkel registrering av hver pasient. Jeg vet også at det er et problem på mange norske sykehus, hvor du har atskillig færre pasienter, å få registrert der og da. I journalen (...) er det mangelfullt. Med å ha [dette programmet] tvinges man til å foreta registreringene der og da.*

*De recommendations er nok noe som må jobbes en god del mer med, men det er en veldig god start de enkle reglene som er lagt inn.*

*(...)*

*Det viktigste er at registreringssystemet fungerer og at kurven fungerer, sammen med pasientinformasjonen og at det er lett å finne tilbake til det, og det ser det ut som at det gjør. (...) Og de recommendations som da kommer opp blir et positivt tilskudd til det, som vil kunne være positivt for behandlingen. (...)*

*At de [håndholdte pc-ene] er viktige er jeg helt sikker på. (...) [En bærbar pc] tar plass. Det er lett å skade den under transport også. (...) [Håndholdte pc-er] tåler støt og støv bedre. (...)*

#### **6. Vil dette programmet kunne gjøre deg mer effektiv som lege?**

*Registreringen vil bli mer effektiv, (...) den blir mye mer pålitelig og effektiv. Når det gjelder behandlingen så er det avhengig av hvor mye erfaring du har. For de som har mye erfaring, de har dette i hodet. Men det tar jo lang tid å komme til den erfaringen, (...) for de som sitter med få pasienter, og som kanskje er i starten av sin*

*erfaringskurve, vil dette være til stor hjelp. (...) Der Ponseti-behandlingen startet der bruker de ingen form for klassifisering. De har alle dette i hodet. (...) Men all litteratur har vist at der du har en god registrering der blir kvaliteten bedre. En som kanskje har hatt 40 pasienter har møtt noen problemer, men en som har sett flere hundre pasienter han kjenner umiddelbart igjen problemene. Han trenger ikke noe rådgivningsverktøy for å kunne ta rette beslutninger. Men gjennom et rådgivningsverktøy så kan den personen som har mye erfaring formidle kunnskap til de andre.*

- **Kan det være gunstig å ha et rådgivningsverktøy i forhold til spesialtilfellene i behandlingen?**

*Ja, absolutt. De [tilfellene] som går greit, de er veldig ukompliserte, men [i] alle [tilfellene] som ikke går greit der vil [programmet] være til god hjelp.*

*(...)*

## APPENDIX C – Transcription of interview 2

---

### 1. Hvor enkelt vil du si at det er å:

- Registrere ny pasient

*Ja, det er lett. Når du kjenner bruken av systemet så er det lett. (...)*

- Gjenfinne registrert pasient

*Fikk ikke brukt det så mye, men det ser jo lett ut. Men det er klart at hvis du har 1000 pasienter inne så blir det jo verre.*

*(...)*

- Registrere ny konsultasjon

*Ja, det er jo lett. Det synes jeg var veldig lett.*

- Gjenfinne og se på en allerede lagret konsultasjon

*Ja, det er lett på denne korte gjennomgangen her. Når man får brukt [programmet] på en 3-4 pasienter så tror jeg det går lett.*

### 2. Hvordan var det å registrere informasjon på den håndholdte pc-en?

*Det er lett. Synes det virker greit. Jeg har ikke [håndholdt pc], så jeg har ikke brukt [en slik].*

- Det er første gangen du bruker en håndholdt pc?

*Ja, det er første. Jeg har ikke brukt dette her før.*

### 3. Hvordan var det å vise informasjon på den håndholdte pc-en?

*(...) Det var veldig greit. God kvalitet på bildene og grei graf.*

### 4. Er en håndholdt pc mer egnet enn en vanlig pc til dette formålet?

*Jeg tror nesten jeg ville foretrukket en bærbar, men det er bare fordi jeg er vant til det.*

- Hvordan er behandlingssituasjonen din, er du på ett sted hele tiden?

*Jeg er på et rom med en fast pc, (...) [hvor] jeg logger på den elektroniske [pasient]journalen.*

- Er du det når du gipser også?

*Ja, det er på et rom med en datamaskin til stede.*

## 5. Oppfyller systemet dine behov som lege?

*Ja, det vil jeg tro. Jeg tror det er (...) nyttig for de som ikke er så trent og gjerne ikke har satt seg så mye inn i [behandlingen av klumpfot]. Da tror jeg det vil være nyttig, slik at man kan følge en “kokebok”, og så gjøre de kommandoene som kommer opp.*

- **Hvordan ser du for deg at det ville være for deg å bruke dette systemet?**

*Jeg tror jeg klarer meg uten, for å si det sånn. (...) Ser jo med den klumpfotbehandlingen at det har blitt veldig lett, fordi at du følger på en måte en “kokebok”. Det er veldig lett å forholde seg til, både når du følger behandlingen og hvis du får tilbakefall, så har du ganske klare retningslinjer på hva du skal gjøre.*

- **Du tror programmet egner seg bedre for de som ikke er så erfarne?**

*Ja, jeg vil tro det.*

*(...)*

*Det siste halvåret har det vært veldig travelt og da har vi vært veldig dårlige med å registrere [Pirani-scoring], vi bare gipser og ser hva som skjer, og tar det fra gang til gang.*

*(...)*

- **Bruker du Pirani-scoring til vanlig?**

*Ja, jeg prøver å bruk det, men det er mest for å få det registrert. Det er ikke så nyttig nå som det var i begynnelsen. (...) Jeg tror det at etter hvert som du får mer erfaring så gipser du og så vet du hva som skjer. (...)*

## 6. Vil dette programmet kunne gjøre deg mer effektiv som lege?

*Ikke akkurat her på stedet, det tror jeg ikke. Jeg vil tro at hvis du er på et sted hvor du har sykepleiere, fysioterapeuter eller leger som er ferske i dette her og som skal behandle veldig mange så tror jeg at det er nyttig i begynnelsen i hvert fall.*

- **Mer som en treningshjelp?**

*Ja, og som et verktøy til å komme seg inn i (...) behandlingsrutinen.*

- **Tror du at programmet kunne hjulpet deg i forhold til registrering?**

*Ja, det er veldig fort og lett å registrere.*

- **Hvordan synes du programmet er i forhold til det papirskjemaet som du nå bruker?**

*Det som er greit med papirskjemaet er at når du har skrevet det så ligger det der. (...) Da ser man fort at [kurven] faller.*

- **Synes du det er enklere å bruke papirskjema?**

*Ja, på en måte er det det. Det som er gunstig med [dataprogrammet] er at du får opp bildene [av det som skal klassifiseres] hver gang. Du gjenkjenner bildet og kan se på foten og gjenkjenne bildet. Så det kan jo hende at det faktisk blir riktigere ved å bruke bildene hver eneste gang. Det er litt vanskelig å si.*

**7. Er det noe som kan eller bør forbedres i programmet?**

*(...) Kanskje du kunne fått opp et [skjerm]bilde hvor det stod (...) [en oversikt over hver scoring av foten], det hadde vært en fordel. (...) Ellers så synes jeg det var kjapt og greit.*

## APPENDIX D – Transcription of interview 3

---

### 1. Hvor enkelt vil du si at det er å:

- Registrere ny pasient

*Det synes jeg var enkelt.*

- Gjenfinne registrert pasient

*Det synes jeg òg var veldig enkelt.*

- Registrere ny konsultasjon

*Det synes jeg så veldig greit ut det òg. Synes det var bra.*

- Var det noe som burde vært gjort annerledes?

*Nei, jeg synes det var veldig brukervennlig egentlig.*

- Gjenfinne og se på en allerede lagret konsultasjon

*(...) Det er litt dumt du må vite at tastaturet [skjuler menyen], (...) plutselig så vet du ikke hva du skal gjøre. Du må få et tips om at du må vekk med [tastaturet] for å få opp menyen. (...) Jeg synes det så bra ut. (...) Det er ikke helt intuitivt akkurat det [med tastaturet].*

*(...)*

### 2. Hvordan var det å registrere informasjon på den håndholdte pc-en?

*Det synes jeg gikk veldig fint.*

- Har du mye erfaring med å bruke håndholdte pc-er?

*Nei. Veldig lite. (...) Jeg har ikke noe erfaring med den type pc. (...)*

### 3. Hvordan var det å vise informasjon på den håndholdte pc-en?

*Jeg synes det gikk veldig fint, spesielt den der Pirani-scoren synes jeg var utrolig pedagogisk og bra, veldig bra at du bare kan trykke [på bilder] i stedet for å skrive inn tall. (...)*

### 4. Er en håndholdt pc mer egnet enn en vanlig pc til dette formålet?

*(...) Jeg ville foretrukket [en håndholdt pc] fordi jeg tror det er mer anvendelig til å kunne ta med fram og tilbake til jobb. Litt lettere sannsynligvis å ha strøm nok, det er mer styr med en pc vil jeg tro. Jeg har ikke brukt en sånn håndholdt så jeg vet ikke hvor mye styr det egentlig er. (...) Det hoper seg opp på poliklinikken, så det er mye greiere med [en håndholdt pc].*

- **Hvordan er behandlingssituasjonen din, er du på ett sted hele tiden?**

*Det er ofte flere rom. Og da er det greit å ta den [håndholdte pc-en] med seg.*

- **Er det pc på de rommene du behandler på?**

*Ja, det er det. Men det er litt avhengig av hvor du er, her [på sykehuset] kunne man tenkt seg å bruke en pc (...) vi bruker jo de allikevel. (...) Hvis (...) det ikke er pc på alle rommene, da er det jo veldig viktig med en [håndholdt pc]. Jeg vil tippe at det er viktigere der fasilitetene ikke er så store.*

- **Hvis du skal gå mellom flere rom, måtte du da ha logget deg på hver pc på hvert rom?**

*(...) Ja, det går jo an. Vi gjør det. Vi har to pc-er som vi er pålogget på. (...) Det er ingen begrensninger, man kan være logget på så mange pc-er du vil på en gang. Ellers hadde det vært håpløst, kan ikke drive å logge deg av og på hele tiden.*

## **5. Oppfyller systemet dine behov som lege?**

*Ja, jeg ikke klage på systemet. Det jeg er litt usikker på er når det blir komplekst. (...) Føtter som er vanskelige å behandle tror jeg kan bli vanskelige å få inn i et sånt skjematisk forløp. Jeg tror det kan bli litt irriterende at i tillegg til å ha en vanskelig fot så skal du få det til å passe inn i dette programmet, det ser jeg på som en utfordring. Men på det jevne, med en klumpfot som går greit så tror jeg det er bra. (...) Det er ikke så lett å [dekke] alle eventualitetene. Men så langt som jeg ser så synes jeg det virket veldig bra.*

## **6. Vil dette programmet kunne gjøre deg mer effektiv som lege?**

*Det spørres hvilket formål man har til programmet. For å få tips til min egen behandling så ville jeg ikke ha brukt det, for jeg føler at hvis du kan det så er det lett. (...) For å registrere pasienter i en database, med formål å se hvordan det går med de, så synes jeg absolutt det ville være interessant å bruke det som et ledd i forskning og sånne ting. Det er veldig nyttig å få registrert på en lettvin måte. Det virker ikke som at det tar noe særlig lang tid. Jeg synes absolutt at det var brukervennlig.*

## **7. Er det noe som kan eller bør forbedres i programmet?**

*Hvis jeg skulle ha brukt dette [systemet] så ville jeg (...) prøvd å gjort det enklere med minst mulig data som ikke [trengs] å fylles ut. Samtidig er jeg veldig positiv til at (...) det er veldig få ting som MÅ fylles ut. (...) Ting du aldri bruker er godt å ikke se, det har med å gjøre det enklest mulig å gjøre. Det er viktig. (...) Så langt jeg kunne se så var [programmet] veldig bra. (...)*



## APPENDIX E – Decision tree errors and warnings

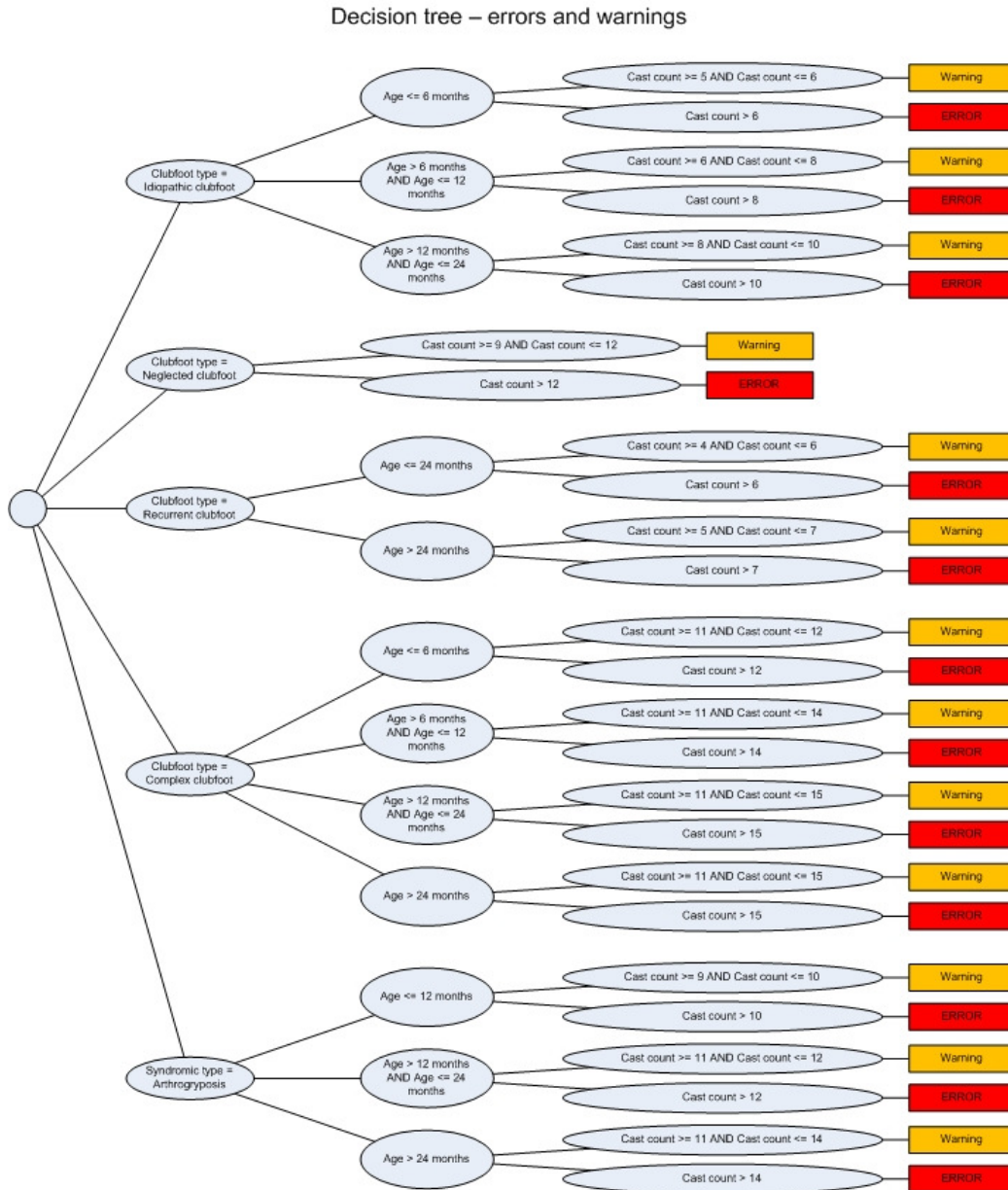

## APPENDIX F – Clubfoot workflow

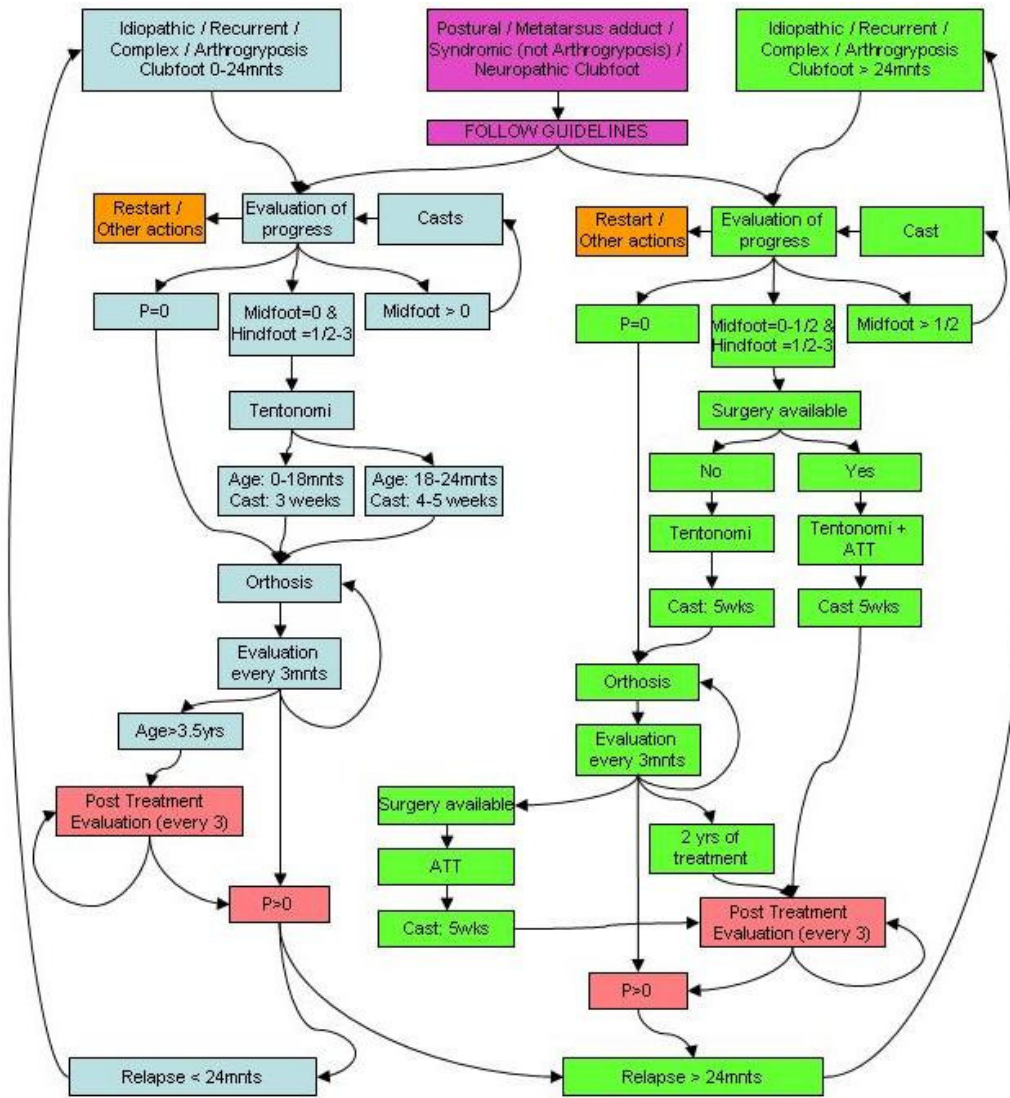

**APPENDIX G – Clubfoot errors and warnings**

<b>Clubfoot type</b>	<b>Months</b>	<b>OK</b>	<b>Warning</b>	<b>Error</b>
<i>Idiopathic</i>	0-6	$\leq 4$	5-6	$> 6$
	6-12	$\leq 5$	6-8	$> 8$
	12-24	$\leq 7$	8-10	$> 10$
<i>Neglected (Idiopathic &gt; 24mnts)</i>	$> 24$	$\leq 8$	9-12	$> 12$
<i>Recurrent</i>	0-24	$\leq 3$	4-6	$> 6$
	$> 24$	$\leq 4$	5-7	$> 7$
<i>Complex</i>	0-6	$\leq 10$	11-12	$> 12$
	6-12	$\leq 10$	11-14	$> 14$
	12-24	$\leq 10$	11-15	$> 15$
	$> 24$	$\leq 10$	11-15	$> 15$
<i>Arthrogryposis</i>	0-12	$\leq 8$	9-10	$> 10$
	12-24	$\leq 10$	11-12	$> 12$
	$> 24$	$\leq 10$	11-14	$> 14$
<i>Postural</i>	$\geq 0$	$< 0$	$\geq 0$	N/A
<i>Metatarsus adduct</i>	$\geq 0$	$< 0$	$\geq 0$	N/A
<i>Syndromic - except Arthrogryposis</i>	$\geq 0$	$< 0$	$\geq 0$	N/A
<i>Neuropathic</i>	$\geq 0$	$< 0$	$\geq 0$	N/A

## APPENDIX H – Pirani score form

Pas.navn: .....

Vedlegg 2

Pers. nr.:

### Scoringsskjema.



Fyller ut ved hver konsultasjon før tøyning og gipsing.



Dato:														
Side:	H	V	H	V	H	V	H	V	H	V	H	V	H	V
Bakre fure														
Tom hæl														
Motstand mot equinus														
<b>Poeng Bakfot</b>														
Mediale Fure														
Laterale Talushode														
Laterale Kurvatur														
<b>Poeng Midfot</b>														
<b>Total Score</b>														



### Pirani score

**LOOK**

Curvature of Lateral Border      Medial Crease      Posterior Crease

0 = Normal                  



0.5 = Moderate                  



1 = Severe                  

---

**FEEL**

Lateral Part of Head of Talus      Emptiness of the Heel

0 = Complete reduction            0 = Tuberosity      



0.5 = Partial reduction            1 = Tuberosity not palpable      

1 = Fixed subluxed      

---

**MOVE**

Rigidity of Equinus

0            0.5            1      

Høyre:

Venstre:

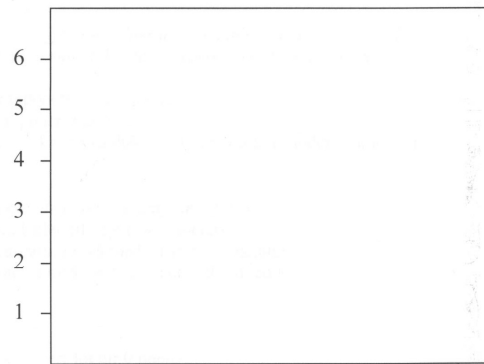
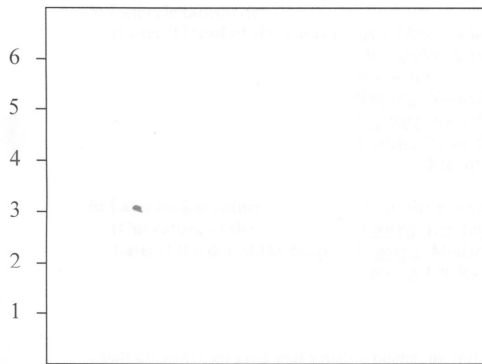

Ginsnr. 1 2 3 4 5 6 7 8

1 2 3 4 5 6 7 8

Klumpfotstudien Engesæter/ Sætersdal 12.02.04

## APPENDIX I – Rules engine evaluation 1

Patient	Date of birth	Date	Treatment	Advice	Status/Reason
1	12.12.07 <sup>3</sup>	12.02.08	Cast right foot 1w Cast left foot 1w	Cast right foot 1w Cast left foot 1w	OK
2	12.10.07 <sup>3</sup>	12.02.08	Tenotomy left foot Cast left foot 3w Tenotomy right foot Cast right foot 3w	Tenotomy left foot Cast left foot 3w Tenotomy right foot Cast right foot 3w	OK
3	12.05.07 <sup>3</sup>	12.02.08	Cast right foot 1w Cast left foot 1w	Cast right foot 1w Tenotomy left foot Cast left foot 3w	Correct advice given according to the rules. Rules are not correct. When both feet are affected, tenotomy should not be performed until both feet have midfoot = 0. The rules needs to be updated accordingly.
4	12.02.07 <sup>3</sup>	12.02.08	Tenotomy left foot Cast left foot 3w Tenotomy right foot Cast right foot 3w	Tenotomy left foot Cast left foot 3w Tenotomy right foot Cast right foot 3w	OK
5	12.08.06 <sup>3</sup>	12.02.08	Tenotomy left foot Cast left foot 3w Tenotomy right foot Cast right foot 3w	Tenotomy left foot Cast left foot 3w Tenotomy right foot Cast right foot 3w	OK
6	12.11.07 <sup>3</sup>	12.02.08	Tenotomy right foot Cast right foot 3w	Tenotomy right foot Cast right foot 3w	OK
7	12.09.07 <sup>3</sup>	12.02.08	Continue orthosis right foot Continue orthosis left foot	Start othosis right foot Start othosis left foot	Correct advice given according to the rules. Patient is already using orthosis, thus the rules must be updated with rules regarding this.
8	12.02.06 <sup>3</sup>	12.02.08	Continue orthosis right foot Continue orthosis left foot	Start othosis right foot Start othosis left foot	Correct advice given according to the rules. Patient is already using orthosis, thus the rules must be updated with rules regarding this.

<sup>3</sup> Estimated date of birth

## APPENDIX J – Rules engine evaluation 2

Patient	Date of birth	Date	Treatment	Advice	Status/Reason
1	14.01.08	22.01.08	Cast right foot 1w	Cast right foot 1w	OK
		29.01.08	Cast right foot 1w	Cast right foot 1w	OK
		12.02.08	Cast right foot 1w	Cast right foot 1w	OK
		26.02.08	Cast right foot 1w	Cast right foot 1w	OK
		05.03.08	Cast right foot 1w	Cast right foot 1w	OK
		11.03.08	Tenotomy right foot Cast right foot 3w	- Warning, check treatment of right foot - Cast right foot 1w	Tenotomy performed, even though midfoot != 0. Correct advice according to decision tree.
2	05.02.08	12.02.08	Cast left foot 1w	Cast left foot 1w	OK
		26.02.08	Cast left foot 1w	Tenotomy left foot Cast left foot 3w	Tenotomy not performed, even though midfoot = 0. Correct advice according to decision tree.
		05.03.08	Tenotomy left foot Cast left foot 3w	N/A	N/A
3	06.02.08	29.02.08	Cast left foot 1w Cast right foot 1w	Cast left foot 1w Cast right foot 1w	OK
		04.03.08	Cast left foot 1w Cast right foot 1w	Cast right foot 1w Tenotomy left foot Cast left foot 3w	Tenotomy not performed on left foot, even though midfoot = 0. Correct advice according to decision tree. Advice on right foot OK.
		07.03.08	Cast left foot 1w Cast right foot 1w	Left foot N/A Cast right foot 1w	Left foot N/A Right foot OK
		12.03.08	Cast left foot 1w Cast right foot 1w	Left foot N/A Cast right foot 1w	Left foot N/A Right foot OK
		14.03.08	Tenotomy left foot Cast left foot 3w Tenotomy right foot Cast right foot 3w	Left foot N/A Cast right foot 1w	Left foot N/A Tenotomy performed, even though midfoot != 0. Correct advice according to decision tree.
4	09.02.08	11.02.08	Cast left foot 1w Cast right foot 1w	Cast left foot 1w Cast right foot 1w	OK
		14.02.08	Cast left foot 1w Cast right foot 1w	Cast left foot 1w Cast right foot 1w	OK
		26.02.08	Cast left foot 1w Cast right foot 1w	Cast left foot 1w Cast right foot 1w	OK

APPENDIX J – Rules engine evaluation 2

		04.03.08	Cast left foot 1w Cast right foot 1w	Cast left foot 1w Cast right foot 1w	OK
		11.03.08	Tenotomy left foot Cast left foot 3w Tenotomy right foot Cast right foot 3w	Cast left foot 1w Cast right foot 1w	Tenotomy performed, even though midfoot != 0. Correct advice according to decision tree.
5	17.02.07	19.02.07	Cast right foot 1w	Cast right foot 1w	OK
		23.02.07	Cast right foot 1w	Cast right foot 1w	OK
		27.02.07	Cast right foot 1w	Cast right foot 1w	OK
		06.03.07	Cast right foot 1w	Cast right foot 1w	OK
		13.03.07	Cast right foot 1w	Cast right foot 1w	OK
		? (20.03.07)	Tenotomy right foot Cast right foot 3w	- Tenotomy right foot - Cast right foot 3w - Warning, check treatment of right foot	OK
6	17.03.07	21.03.07	Cast left foot 1w	Cast left foot 1w	OK
		27.03.07	Cast left foot 1w	Cast left foot 1w	OK
		03.04.07	Cast left foot 1w	Cast left foot 1w	OK
		10.04.07	Cast left foot 1w	- Tenotomy left foot - Cast left foot 3w	Tenotomy not performed on left foot, even though midfoot = 0. Correct advice according to decision tree.
		17.04.07	Tenotomy left foot Cast left foot 3w	N/A	N/A
7	05.04.07	10.04.07	Cast right foot 1w	Cast right foot 1w	OK
		17.04.07	Cast right foot 1w	Cast right foot 1w	OK
		24.04.07	Cast right foot 1w	Cast right foot 1w	OK
		30.04.07	Cast right foot 1w	Cast right foot 1w	OK
		08.05.07	Tenotomy right foot Cast right foot 3w	Cast right foot 1w	Tenotomy performed, even though midfoot != 0. Correct advice according to decision tree.
8	25.04.07	27.04.07	Cast left foot 1w Cast right foot 1w	Cast left foot 1w Cast right foot 1w	OK
		02.05.07	Cast left foot 1w Cast right foot 1w	Cast left foot 1w Cast right foot 1w	OK
		08.05.07	Cast left foot 1w Cast right foot	Cast left foot 1w Cast right foot	OK

APPENDIX J – Rules engine evaluation 2

			1w Cast left foot 1w Cast right foot 1w	1w - Tenotomy left foot - Cast left foot 3w - Tenotomy right foot - Cast right foot 3w	Tenotomy not performed on left and right foot, even though midfoot = 0. Correct advice according to decision tree.
		15.05.07	Tenotomy left foot Cast left foot 3w Tenotomy right foot Cast right foot 3w	N/A	N/A
		22.05.07			
9	25.06.07	27.06.07	Cast left foot 1w Cast right foot 1w	Cast left foot 1w Cast right foot 1w	OK
		10.07.07	Cast left foot 1w Cast right foot 1w	Cast left foot 1w Cast right foot 1w	OK
		17.07.07	Tenotomy left foot Cast left foot 3w Tenotomy right foot Cast right foot 3w	Tenotomy left foot Cast left foot 3w Tenotomy right foot Cast right foot 3w	OK
10	20.07.07	31.07.07	Cast left foot 1w	Cast left foot 1w	OK
		14.08.07	Cast left foot 1w	Cast left foot 1w	OK
		21.08.07	Cast left foot 1w	Cast left foot 1w	OK
		28.08.07	Tenotomy left foot Cast left foot 3w	Cast left foot 1w	Tenotomy not performed on left foot, even though midfoot = 0. Correct advice according to decision tree.
11	01.09.07	04.09.07	Cast left foot 1w Cast right foot 1w	Cast left foot 1w Cast right foot 1w	OK
		02.10.07	Cast left foot 1w Cast right foot 1w	Cast left foot 1w Cast right foot 1w	OK
		09.10.07	Cast left foot 1w Cast right foot 1w	Cast left foot 1w Cast right foot 1w	OK
		16.10.07	Cast left foot 1w Cast right foot 1w	Cast left foot 1w Cast right foot 1w	OK
		23.10.07	Tenotomy left foot Cast left foot 3w Tenotomy right foot Cast right foot 3w	Tenotomy left foot Cast left foot 3w Tenotomy right foot Cast right foot 3w	OK
12	07.10.07	09.10.07	Cast right foot 1w	Cast right foot 1w	OK
		16.10.07	Cast right foot 1w	Cast right foot 1w	OK



APPENDIX J – Rules engine evaluation 2

		23.10.07	Cast right foot 1w	Tenotomy right foot Cast right foot 3w	Tenotomy not performed on right foot, even though midfoot = 0. Correct advice according to decision tree.
		30.10.07	Tenotomy right foot Cast right foot 3w	N/A	N/A
13	10.03.06	14.03.06	Cast left foot 1w Cast right foot 1w	Cast left foot 1w Cast right foot 1w	OK
		20.03.06	Cast left foot 1w Cast right foot 1w	Cast left foot 1w Cast right foot 1w	OK
		28.03.06	Cast left foot 1w Cast right foot 1w	Cast left foot 1w Cast right foot 1w	OK
		04.04.06	Cast left foot 1w Cast right foot 1w	Cast left foot 1w Cast right foot 1w	OK
		18.04.06	Cast left foot 1w Cast right foot 1w	Tenotomy left foot Cast left foot 3w Tenotomy right foot Cast right foot 3w	Tenotomy not performed on right and left foot, even though midfoot = 0. Correct advice according to decision tree.
		25.04.06	Cast left foot 1w Cast right foot 1w	N/A	N/A
		02.05.06	Tenotomy left foot Cast left foot 3w Tenotomy right foot Cast right foot 3w	N/A	N/A
14	18.03.06	21.03.06	Cast left foot 1w	Cast left foot 1w	OK
		28.03.06	Cast left foot 1w	Cast left foot 1w	OK
		04.04.06	Cast left foot 1w	Cast left foot 1w	OK
		11.04.06	Cast left foot 1w	Tenotomy left foot Cast left foot 3w	Tenotomy not performed on left foot, even though midfoot = 0. Correct advice according to decision tree.
		18.04.06	Cast left foot 1w	N/A	N/A
		25.04.06	Tenotomy left foot Cast left foot 3w	N/A	N/A
15	02.05.06	04.05.06	Cast left foot 1w Cast right foot 1w	Cast left foot 1w Cast right foot 1w	OK
		09.05.06	Cast left foot 1w Cast right foot 1w	Cast left foot 1w Cast right foot 1w	OK
		16.05.06	Cast left foot 1w Cast right foot 1w	Cast left foot 1w Cast right foot 1w	OK
		23.05.06	Cast left foot 1w	Tenotomy left	Tenotomy not performed

APPENDIX J – Rules engine evaluation 2

			Cast right foot 1w	foot Cast left foot 3w Tenotomy right foot Cast right foot 3w	on left and right foot, even though midfoot = 0. Correct advice according to decision tree.
		30.05.06	Cast left foot 1w Cast right foot 1w	N/A	N/A
		06.06.06	Cast left foot 1w Cast right foot 1w	N/A	N/A
		13.06.06	Tenotomy left foot Cast left foot 3w Tenotomy right foot Cast right foot 3w	N/A	N/A
16	03.08.06	15.08.06	Cast left foot 1w Cast right foot 1w	Cast left foot 1w Cast right foot 1w	OK
		22.08.06	Cast left foot 1w Cast right foot 1w	Cast left foot 1w Cast right foot 1w	OK
		29.08.06	Cast left foot 1w Cast right foot 1w	Cast left foot 1w Cast right foot 1w	OK
		05.09.06	Cast left foot 1w Cast right foot 1w	Cast left foot 1w Cast right foot 1w	OK
		12.09.06	Tenotomy left foot Cast left foot 3w Tenotomy right foot Cast right foot 3w	Tenotomy left foot Cast left foot 3w Tenotomy right foot Cast right foot 3w	OK
17	17.10.06	31.10.06	Cast left foot 1w	Cast left foot 1w	OK
		07.11.06	Cast left foot 1w	Cast left foot 1w	OK
		14.11.06	Cast left foot 1w	Cast left foot 1w	OK
		21.11.06	Cast left foot 1w	Cast left foot 1w	OK
		28.11.06	Cast left foot 1w	Cast left foot 1w	OK
		05.12.06	Tenotomy left foot Cast left foot 3w	- Tenotomy left foot - Cast left foot 3w - Warning, check treatment of left foot	OK

## APPENDIX K – Guideline configuration DTD

---

```

<?xml version="1.0" encoding="UTF-8"?>
<!ELEMENT GenSupportConfiguration (Metadata, Actions, Step+)>
<!ELEMENT Actions (Action+)>
<!ELEMENT Action (#PCDATA) >
<!ATTLIST Action Id CDATA #REQUIRED>
<!-- Metadata -->
<!ELEMENT Metadata (Title, Author, Description, DateCreated, Change*)>
<!ELEMENT Title (#PCDATA)>
<!ELEMENT Author (#PCDATA)>
<!ELEMENT Description (#PCDATA)>
<!ELEMENT DateCreated (#PCDATA)>
<!-- Change -->
<!ELEMENT Change (ChangedBy, ChangeDate, ChangeReason)>
<!ELEMENT ChangedBy (#PCDATA)>
<!ELEMENT ChangeDate (#PCDATA)>
<!ELEMENT ChangeReason (#PCDATA)>
<!-- Step -->
<!ELEMENT Step (Title, Description, LibraryResource*, NextStep*, (DataForm |
Classification | RecommendationSet))>
<!ATTLIST Step Id CDATA #REQUIRED>
<!ATTLIST Step Static (true|false) #REQUIRED>
<!ATTLIST Step FirstStep (true) #IMPLIED>
<!ELEMENT NextStep (Condition, StepID)>
<!ELEMENT Condition (#PCDATA)>
<!ELEMENT StepID (#PCDATA)>
<!ELEMENT LibraryResource (#PCDATA)>
<!ELEMENT Group (Title, Condition?, Field+)>
<!ELEMENT Tab (Title, Condition?, (Field | Group)+)>
<!-- Classification-->
<!ELEMENT Classification (ClassificationGroup*)>
<!ELEMENT ClassificationGroup (Title, ClassificationItemImage*)>
<!ELEMENT ClassificationItemImage (Title, Description, ImageItemNumericvalue*)>
<!ATTLIST ClassificationItemImage Id CDATA #REQUIRED>
<!ELEMENT ImageItemNumericvalue (ImagePath, Value)>
<!ELEMENT ImagePath (#PCDATA)>
<!-- Recommendation-->
<!ELEMENT RecommendationSet (Node+)>
<!ELEMENT Node (Condition, (Node+|Statement+))>
<!ELEMENT Statement (Recommendation | Error | Warning)>
<!ELEMENT Recommendation (ActionID)>
<!ATTLIST Recommendation Id CDATA #REQUIRED>
<!ELEMENT ActionID (#PCDATA)>
<!ELEMENT Error (Message)>
<!ATTLIST Error Id CDATA #REQUIRED>
<!ELEMENT Warning (Message)>
<!ATTLIST Warning Id CDATA #REQUIRED>
<!ELEMENT Message (#PCDATA)>

```

## APPENDIX K – Guideline configuration DTD

```
<!-- DataForm-->
<!ELEMENT DataForm (Tab+ | (Field | Group)+)>
<!-- Field -->
<!ELEMENT Field (Title, Condition?, (Text | String | Number | Multi | Boolean |
Date))>
<!ATTLIST Field Id CDATA #REQUIRED>
<!ATTLIST Field Mandatory (yes|no) "no">
<!ELEMENT Text (#PCDATA)>
<!ELEMENT String (MinLength?, MaxLength?)>
<!ELEMENT MinLength (#PCDATA)>
<!ELEMENT MaxLength (#PCDATA)>
<!ELEMENT Number (MinValue?, MaxValue?, Decimals?)>
<!ELEMENT MinValue (#PCDATA)>
<!ELEMENT MaxValue (#PCDATA)>
<!ELEMENT Decimals (#PCDATA)>
<!ELEMENT Multi (Value+)>
<!ATTLIST Multi Type (dropdown|selectMulti|selectSingle) #REQUIRED>
<!ELEMENT Value (#PCDATA)>
<!ELEMENT Date (MinDate?, MaxDate?)>
<!ELEMENT MinDate (#PCDATA)>
<!ELEMENT MaxDate (#PCDATA)>
<!ELEMENT Boolean (True, False)?>
<!ELEMENT True (#PCDATA)>
<!ELEMENT False (#PCDATA)>
```

## APPENDIX L – Clubfoot configuration XML

---

```

<?xml version="1.0" encoding="UTF-8"?>
<!--DOCTYPE GenSupportConfiguration SYSTEM "configuration.dtd"-->

<GenSupportConfiguration>

  <Metadata>
    <Title>Clubfoot</Title>
    <Author>Dag Skjelvik</Author>
    <Description>A test implementation of a guideline for clubfoot
treatment</Description>
    <DateCreated>01.02.2008</DateCreated>
  </Metadata>

  <Actions>
    <Action Id="right_orthosis">Start orthosis right foot</Action>
    <Action Id="right_order_orthosis">Measure right foot and order
orthosis</Action>
    <Action Id="right_cast3w">Cast right foot for 3 weeks</Action>
    <Action Id="right_cast4w">Cast right foot for 4-5 weeks</Action>
    <Action Id="right_cast5w">Cast right foot for 5 weeks</Action>
    <Action Id="right_tenotomy">Perform tenotomy on right foot</Action>
    <Action Id="right_att">Perform ATT on right foot</Action>
    <Action Id="right_cast">Apply cast on right foot</Action>

    <Action Id="left_orthosis">Start orthosis left foot</Action>
    <Action Id="left_order_orthosis">Measure left foot and order orthosis</Action>
    <Action Id="left_cast3w">Cast left foot for 3 weeks</Action>
    <Action Id="left_cast4w">Cast left foot for 4-5 weeks</Action>
    <Action Id="left_cast5w">Cast left foot for 5 weeks</Action>
    <Action Id="left_tenotomy">Perform tenotomy on left foot</Action>
    <Action Id="left_att">Perform ATT on left foot</Action>
    <Action Id="left_cast">Apply cast on left foot</Action>
  </Actions>

  <Step Id="clinical_static_information" Static="true" FirstStep="true">
    <Title>Clinical static information</Title>
    <Description>Clinical static information</Description>

    <NextStep>
      <Condition>GetSequenceNumberOfCurrentEncounter() = 1</Condition>
      <StepID>capability_to_comply_to_treatment</StepID>
    </NextStep>

    <NextStep>
      <Condition>Treatment.ActionPerformed("right_cast") OR
      Treatment.ActionPerformed("left_cast")</Condition>
      <StepID>control_questions_removing_cast</StepID>
    </NextStep>

    <NextStep>
      <Condition>Treatment.ActionPerformed("right_orthosis") OR
      Treatment.ActionPerformed("left_orthosis")</Condition>
      <StepID>orthosis_compliance</StepID>
    </NextStep>

    <NextStep>

    <Condition>Encounter.GetStep("clinical_static_information").GetStringValueOfField("side_affected")
      = "Bilateral"</Condition>
      <StepID>pirani_left_foot</StepID>
    </NextStep>

    <NextStep>

    <Condition>Encounter.GetStep("clinical_static_information").GetStringValueOfField("side_affected")
      = "Left"</Condition>
      <StepID>pirani_left_foot</StepID>
    </NextStep>

    <NextStep>
  </Step>

```

## APPENDIX L – Clubfoot configuration XML

```
<Condition>Encounter.GetStep("clinical_static_information").GetStringValueOfField("side_affected")
    = "Right"</Condition>
    <StepID>pirani_right_foot</StepID>
</NextStep>

<DataForm>
    <Tab>
        <Title>Clubfoot</Title>

        <Field Id="clubfoot_type" Mandatory="yes">
            <Title>Clubfoot type</Title>
            <Multi Type="dropdown">
                <Value>Idiopathic clubfoot</Value>
                <Value>Syndromic clubfoot</Value>
                <Value>Neuropathic clubfoot</Value>
                <Value>Recurrent clubfoot</Value>
                <Value>Postural clubfoot</Value>
                <Value>Metatarsus adduct</Value>
                <Value>Complex clubfoot</Value>
                <Value>Neglected clubfoot</Value>
            </Multi>
        </Field>

        <Field Id="syndromic_type">
            <Title>Syndromic type</Title>
            <Multi Type="dropdown">
                <Value>Arthrogryposis</Value>
                <Value>Larsens Syndrome</Value>
                <Value>Other</Value>
            </Multi>
        </Field>

        <Field Id="neuropathic_type">
            <Title>Neuropathic type</Title>
            <Multi Type="dropdown">
                <Value>Myelodisplasia</Value>
                <Value>Other</Value>
            </Multi>
        </Field>

        <Field Id="side_affected" Mandatory="yes">
            <Title>Side affected</Title>
            <Multi Type="dropdown">
                <Value>Right</Value>
                <Value>Left</Value>
                <Value>Bilateral</Value>
            </Multi>
        </Field>

        <Field Id="any_previous_clubfoot_treatment">
            <Title>Any previous clubfoot treatment?</Title>
            <Multi Type="dropdown">
                <Value>Yes</Value>
                <Value>No</Value>
                <Value>Don't know</Value>
            </Multi>
        </Field>

        <Field Id="side_treated">
            <Title>Side Treated</Title>
            <Multi Type="dropdown">
                <Value>Righth</Value>
                <Value>Left</Value>
                <Value>Bilateral</Value>
            </Multi>
        </Field>

    <Group>
        <Title>Right side</Title>

        <Field Id="right_side_number_of_casts">
            <Title>Number of casts</Title>
            <Number>
                <Decimals>0</Decimals>
            </Number>
        </Field>
    </Group>
</DataForm>
```

## APPENDIX L – Clubfoot configuration XML

```

        </Number>
    </Field>

    <Field Id="right_side_tenotomy_performed">
        <Title>Tenotomy performed?</Title>
        <Boolean>
            <True>Yes</True>
            <False>No</False>
        </Boolean>
    </Field>

    <Field Id="right_side_postromedial_release_performed">
        <Title>Postromedial release performed?</Title>
        <Boolean>
            <True>Yes</True>
            <False>No</False>
        </Boolean>
    </Field>

</Group>

<Group>
    <Title>Left side</Title>

    <Field Id="left_side_number_of_casts">
        <Title>Number of casts</Title>
        <Number>
            <Decimals>0</Decimals>
        </Number>
    </Field>

    <Field Id="left_side_tenotomy_performed">
        <Title>Tenotomy performed?</Title>
        <Boolean>
            <True>Yes</True>
            <False>No</False>
        </Boolean>
    </Field>

    <Field Id="left_side_postromedial_release_performed">
        <Title>Postromedial release performed?</Title>
        <Boolean>
            <True>Yes</True>
            <False>No</False>
        </Boolean>
    </Field>

</Group>

<Field Id="previous_treatment_place">
    <Title>Previous treatment place</Title>
    <String/>
</Field>

<Field Id="treatment_started">
    <Title>Treatment started</Title>
    <Date/>
</Field>

<Field Id="treatment_ended">
    <Title>Treatment ended</Title>
    <Date/>
</Field>

<Field Id="complications">
    <Title>Complications</Title>
    <Text/>
</Field>

<Field Id="comments">
    <Title>Comments</Title>
    <Text/>
</Field>

</Tab>

<Tab>

```

## APPENDIX L – Clubfoot configuration XML

```
<Title>Family history </Title>

<Field

Id="is_there_any_other_persons_of_the_family_or_close_relatives_with_clubfoot_deformity">
  <Title>Is there any other persons of the family or close relatives
with clubfoot
  deformity?</Title>
  <Multi Type="dropdown">
    <Value>Yes</Value>
    <Value>No</Value>
    <Value>Don't know</Value>
  </Multi>
</Field>

<Field Id="is_the_child_the_first_born_to_the_mother">
  <Title>The child is number ... to the mother</Title>
  <Multi Type="dropdown">
    <Value>1</Value>
    <Value>2</Value>
    <Value>3</Value>
    <Value>4</Value>
    <Value>5</Value>
    <Value>6</Value>
    <Value>7</Value>
    <Value>8</Value>
    <Value>9</Value>
    <Value>10</Value>
    <Value>11</Value>
    <Value>12</Value>
    <Value>13</Value>
    <Value>14</Value>
    <Value>15</Value>
    <Value>16</Value>
    <Value>17</Value>
    <Value>18</Value>
    <Value>19</Value>
    <Value>20</Value>
  </Multi>
</Field>

</Tab>

<Tab>
  <Title>Physical examination</Title>

  <Field Id="relevant_physical_findings">
    <Title>Relevant physical findings</Title>
    <Boolean>
      <True>Yes</True>
      <False>No</False>
    </Boolean>
  </Field>

  <Field Id="spine">
    <Title>Spine</Title>
    <Text/>
  </Field>

  <Field Id="hips">
    <Title>Hips</Title>
    <Text/>
  </Field>

  <Field Id="neurological">
    <Title>Neurological</Title>
    <Text/>
  </Field>

  <Field Id="upper_extremeties">
    <Title>Upper extremeties</Title>
    <Text/>
  </Field>

  <Field Id="lower_extremeties">
    <Title>Lower extremeties</Title>
```



## APPENDIX L – Clubfoot configuration XML

```

        <Text/>
    </Field>

    <Field Id="other_comments">
        <Title>Other comments</Title>
        <Text/>
    </Field>

</Tab>

</DataForm>
</Step>

<Step Id="capability_to_comply_to_treatment" Static="false">
    <Title>Capabilitiy to comply to treatment</Title>
    <Description>Capabilitiy to comply to treatment</Description>

    <NextStep>
        <Condition>Treatment.ActionPerformed("right_cast") OR
            Treatment.ActionPerformed("left_cast")</Condition>
        <StepID>control_questions_removing_cast</StepID>
    </NextStep>

    <NextStep>
        <Condition>Treatment.ActionPerformed("right_orthosis") OR
            Treatment.ActionPerformed("left_orthosis")</Condition>
        <StepID>orthosis_compliance</StepID>
    </NextStep>

    <NextStep>
        <Condition>Encounter.GetStep("clinical_static_information").GetStringValueOfField("side_affected")
            = "Bilateral"</Condition>
        <StepID>pirani_left_foot</StepID>
    </NextStep>

    <NextStep>
        <Condition>Encounter.GetStep("clinical_static_information").GetStringValueOfField("side_affected")
            = "Left"</Condition>
        <StepID>pirani_left_foot</StepID>
    </NextStep>

    <NextStep>
        <Condition>Encounter.GetStep("clinical_static_information").GetStringValueOfField("side_affected")
            = "Right"</Condition>
        <StepID>pirani_right_foot</StepID>
    </NextStep>

    <DataForm>

        <Field Id="can_treatment_enhance_life_quality">
            <Title>Can treatment enhance life quality?</Title>
            <Boolean>
                <True>yes</True>
                <False>no</False>
            </Boolean>
        </Field>

        <Field Id="able_to_walk_when_treated">
            <Title>Able to walk when treated?</Title>
            <Boolean>
                <True>yes</True>
                <False>no</False>
            </Boolean>
        </Field>

        <Field Id="distance_to_treatment_in_km">
            <Title>Distance to treatment in km</Title>
            <Number>
                <Decimals>1</Decimals>
            </Number>
        </Field>

```

## APPENDIX L – Clubfoot configuration XML

```
<Field Id="transportation">
  <Title>Transportation</Title>
  <Boolean>
    <True>yes</True>
    <False>no</False>
  </Boolean>
</Field>

<Field Id="economy">
  <Title>Economy</Title>
  <Multi Type="dropdown">
    <Value>Bad</Value>
    <Value>Average</Value>
    <Value>Good</Value>
  </Multi>
</Field>

<Field Id="nutrition">
  <Title>Nutrition</Title>
  <Multi Type="dropdown">
    <Value>Bad</Value>
    <Value>Average</Value>
    <Value>Good</Value>
  </Multi>
</Field>

<Field Id="able_to_follow_treatment">
  <Title>Able to follow treatment?</Title>
  <Boolean>
    <True>yes</True>
    <False>no</False>
  </Boolean>
</Field>

<Field Id="able_to_stay_nearby">
  <Title>Able to stay nearby?</Title>
  <Boolean>
    <True>yes</True>
    <False>no</False>
  </Boolean>
</Field>

<Field Id="other_relevant_information">
  <Title>Other relevant information</Title>
  <Text/>
</Field>

<Field Id="should_treatment_be_started">
  <Title>Should treatment be started?</Title>
  <Multi Type="dropdown">
    <Value>Yes</Value>
    <Value>No</Value>
    <Value>Later</Value>
    <Value>Continue</Value>
  </Multi>
</Field>

<Field Id="treatment_in_other_place">
  <Title>Can treatment be given in another place?</Title>
  <String/>
</Field>

</DataForm>
</Step>

<Step Id="control_questions_removing_cast" Static="false">
  <Title>Control questions when removing cast</Title>
  <Description>Control questions when removing cast</Description>

  <NextStep>

  <Condition>Encounter.GetStep("clinical_static_information").GetStringValueOfField("side_affected")
    = "Bilateral"</Condition>
  <StepID>pirani_left_foot</StepID>
```

## APPENDIX L – Clubfoot configuration XML

```

</NextStep>

<NextStep>

<Condition>Encounter.GetStep("clinical_static_information").GetStringValueOfField("side_affected")
    = "Left"</Condition>
    <StepID>pirani_left_foot</StepID>
</NextStep>

<NextStep>

<Condition>Encounter.GetStep("clinical_static_information").GetStringValueOfField("side_affected")
    = "Right"</Condition>
    <StepID>pirani_right_foot</StepID>
</NextStep>

<DataForm>

    <Group>
        <Title>Right foot</Title>

        <Field Id="right_foot_has_the_foot_slipped_in_the_cast">
            <Title>Has the foot slipped in the cast?</Title>
            <Boolean>
                <True>yes</True>
                <False>no</False>
            </Boolean>
        </Field>

        <Field Id="right_foot_is_the_cast_broken_or_damaged">
            <Title>Is the cast broken or damaged?</Title>
            <Boolean>
                <True>yes</True>
                <False>no</False>
            </Boolean>
        </Field>

        <Field Id="right_foot_any_skin_problems">
            <Title>Any skin problems?</Title>
            <Boolean>
                <True>yes</True>
                <False>no</False>
            </Boolean>
        </Field>

        <Field Id="right_foot_comments">
            <Title>Comments</Title>
            <Text/>
        </Field>
    </Group>

    <Group>
        <Title>Left foot</Title>

        <Field Id="left_foot_has_the_foot_slipped_in_the_cast">
            <Title>Has the foot slipped in the cast?</Title>
            <Boolean>
                <True>yes</True>
                <False>no</False>
            </Boolean>
        </Field>

        <Field Id="left_foot_is_the_cast_broken_or_damaged">
            <Title>Is the cast broken or damaged?</Title>
            <Boolean>
                <True>yes</True>
                <False>no</False>
            </Boolean>
        </Field>

        <Field Id="left_foot_any_skin_problems">
            <Title>Any skin problems?</Title>
            <Boolean>
                <True>yes</True>

```

## APPENDIX L – Clubfoot configuration XML

```
        <False>no</False>
      </Boolean>
    </Field>

    <Field Id="left_foot_comments">
      <Title>Comments</Title>
      <Text/>
    </Field>

  </Group>

</DataForm>
</Step>

<Step Id="orthosis_compliance" Static="false">
  <Title>Orthosis compliance</Title>
  <Description>Orthosis compliance</Description>

  <NextStep>

<Condition>Encounter.GetStep("clinical_static_information").GetStringValueOfField("side_affected")
  = "Bilateral"</Condition>
  <StepID>pirani_left_foot</StepID>
</NextStep>

  <NextStep>

<Condition>Encounter.GetStep("clinical_static_information").GetStringValueOfField("side_affected")
  = "Left"</Condition>
  <StepID>pirani_left_foot</StepID>
</NextStep>

  <NextStep>

<Condition>Encounter.GetStep("clinical_static_information").GetStringValueOfField("side_affected")
  = "Right"</Condition>
  <StepID>pirani_right_foot</StepID>
</NextStep>

  <DataForm>

    <Field Id="compliance">
      <Title>Compliance</Title>
      <Multi Type="dropdown">
        <Value>Good</Value>
        <Value>Fair</Value>
        <Value>Poor</Value>
        <Value>None</Value>
      </Multi>
    </Field>

    <Field Id="daily_orthosis_use">
      <Title>Daily orthosis use</Title>
      <Multi Type="dropdown">
        <Value>Less than 12 hours</Value>
        <Value>More than 12 hours</Value>
        <Value>24 hours</Value>
      </Multi>
    </Field>

    <Field Id="is_the_frame_broken">
      <Title>Is the frame broken?</Title>
      <Boolean>
        <True>Yes</True>
        <False>No</False>
      </Boolean>
    </Field>

  <Group>
    <Title>Right foot</Title>
    <Field Id="right_foot_problems_encountered">
      <Title>Problems encountered?</Title>
      <Multi Type="selectMulti">
        <Value>None</Value>
      </Multi>
    </Field>
  </Group>
</Step>
</DataForm>
</Step>
```

## APPENDIX L – Clubfoot configuration XML

```

        <Value>Child not tolerating orthosis</Value>
        <Value>Feet keep sliding out of shoes</Value>
        <Value>Orthosis causes pressure ulcers</Value>
        <Value>Orthosis does not fit</Value>
        <Value>Orthosis use not acceptable to guardian</Value>
        <Value>Heel not down in the shoe</Value>
        <Value>Other</Value>
    </Multi>
</Field>

<Field Id="right_foot_problems_described">
    <Title>Problems described</Title>
    <Text/>
</Field>

<Field Id="right_foot_how_does_the_boot_fit">
    <Title>How does the boot fit?</Title>
    <Boolean>
        <True>Correctly</True>
        <False>Not correctly</False>
    </Boolean>
</Field>

<Field Id="right_foot_position_of_the_shoes">
    <Title>Position of the shoes?</Title>
    <Multi Type="dropdown">
        <Value>40 degrees</Value>
        <Value>70 degrees</Value>
    </Multi>
</Field>
</Group>

<Group>
    <Title>Left foot</Title>
    <Field Id="left_foot_problems_encountered">
        <Title>Problems encountered?</Title>
        <Multi Type="selectMulti">
            <Value>None</Value>
            <Value>Child not tolerating orthosis</Value>
            <Value>Feet keep sliding out of shoes</Value>
            <Value>Orthosis causes pressure ulcers</Value>
            <Value>Orthosis does not fit</Value>
            <Value>Orthosis use not acceptable to guardian</Value>
            <Value>Heel not down in the shoe</Value>
            <Value>Other</Value>
        </Multi>
    </Field>

    <Field Id="left_foot_problems_described">
        <Title>Problems described</Title>
        <Text/>
    </Field>

    <Field Id="left_foot_how_does_the_boot_fit">
        <Title>How does the boot fit?</Title>
        <Boolean>
            <True>Correctly</True>
            <False>Not correctly</False>
        </Boolean>
    </Field>

    <Field Id="left_foot_position_of_the_shoes">
        <Title>Position of the shoes?</Title>
        <Multi Type="dropdown">
            <Value>40 degrees</Value>
            <Value>70 degrees</Value>
        </Multi>
    </Field>
</Group>

</DataForm>
</Step>

<Step Id="pirani_left_foot" Static="false">

```

## APPENDIX L – Clubfoot configuration XML

```
<Title>Pirani scoring, left foot</Title>
<Description>Pirani scoring</Description>

<NextStep>

<Condition>Encounter.GetStep("clinical_static_information").GetStringValueOfField("side_affected")
    = "Bilateral"</Condition>
    <StepID>pirani_right_foot</StepID>
</NextStep>

<NextStep>
    <Condition>Patient.GetAgeInMonths(Encounter.Date) > 24 AND
    GetGroupScoreClassification("pirani_left_foot", "midfoot") <= 0.5 AND
    GetGroupScoreClassification("pirani_left_foot", "hindfoot") > 0</Condition>
    <StepID>surgery_available</StepID>
</NextStep>

<NextStep>
    <Condition>>true</Condition>
    <StepID>recommendations</StepID>
</NextStep>

<Classification>
    <ClassificationGroup>
        <Title>Midfoot</Title>

        <ClassificationItemImage Id="curved_lateral_border">
            <Title>Curved lateral border</Title>
            <Description>Curved lateral border - description</Description>

            <ItemImageNumericvalue>
                <ImagePath>cla1.jpg</ImagePath>
                <Value>0</Value>
            </ItemImageNumericvalue>

            <ItemImageNumericvalue>
                <ImagePath>cla2.jpg</ImagePath>
                <Value>0.5</Value>
            </ItemImageNumericvalue>

            <ItemImageNumericvalue>
                <ImagePath>cla3.jpg</ImagePath>
                <Value>1</Value>
            </ItemImageNumericvalue>
        </ClassificationItemImage>

        <ClassificationItemImage Id="medial_crease">
            <Title>Medial crease</Title>
            <Description>Medial crease - description</Description>

            <ItemImageNumericvalue>
                <ImagePath>mc1.jpg</ImagePath>
                <Value>0</Value>
            </ItemImageNumericvalue>

            <ItemImageNumericvalue>
                <ImagePath>mc2.jpg</ImagePath>
                <Value>0.5</Value>
            </ItemImageNumericvalue>

            <ItemImageNumericvalue>
                <ImagePath>mc3.jpg</ImagePath>
                <Value>1</Value>
            </ItemImageNumericvalue>
        </ClassificationItemImage>

        <ClassificationItemImage Id="talar_head_coverage">
            <Title>Talar head coverage</Title>

            <Description>Talar head coverage - description</Description>

            <ItemImageNumericvalue>
                <ImagePath>thc1.jpg</ImagePath>
```

## APPENDIX L – Clubfoot configuration XML

```
<Value>0</Value>
</ImageItemNumericvalue>

<ImageItemNumericvalue>
  <ImagePath>thc2.jpg</ImagePath>
  <Value>0.5</Value>
</ImageItemNumericvalue>

<ImageItemNumericvalue>
  <ImagePath>thc3.jpg</ImagePath>
  <Value>1</Value>
</ImageItemNumericvalue>

</ClassificationItemImage>
</ClassificationGroup>
<ClassificationGroup>
  <Title>Hindfoot</Title>

  <ClassificationItemImage Id="posterior_crease">
    <Title>Posterior crease</Title>

    <Description>Posterior crease - description</Description>

    <ImageItemNumericvalue>
      <ImagePath>pc1.jpg</ImagePath>
      <Value>0</Value>
    </ImageItemNumericvalue>

    <ImageItemNumericvalue>
      <ImagePath>pc2.jpg</ImagePath>
      <Value>0.5</Value>
    </ImageItemNumericvalue>

    <ImageItemNumericvalue>
      <ImagePath>pc3.jpg</ImagePath>
      <Value>1</Value>
    </ImageItemNumericvalue>

  </ClassificationItemImage>

  <ClassificationItemImage Id="rigid_equinus">
    <Title>Rigid equinus</Title>

    <Description>Rigid equinus - description</Description>

    <ImageItemNumericvalue>
      <ImagePath>re1.jpg</ImagePath>
      <Value>0</Value>
    </ImageItemNumericvalue>

    <ImageItemNumericvalue>
      <ImagePath>re2.jpg</ImagePath>
      <Value>0.5</Value>
    </ImageItemNumericvalue>

    <ImageItemNumericvalue>
      <ImagePath>re3.jpg</ImagePath>
      <Value>1</Value>
    </ImageItemNumericvalue>

  </ClassificationItemImage>

  <ClassificationItemImage Id="empty_heel">
    <Title>Empty heel</Title>

    <Description>Empty heel</Description>

    <ImageItemNumericvalue>
      <ImagePath>eh1.jpg</ImagePath>
      <Value>0</Value>
    </ImageItemNumericvalue>

    <ImageItemNumericvalue>
      <ImagePath>eh2.jpg</ImagePath>
      <Value>0.5</Value>
    </ImageItemNumericvalue>
  </ClassificationItemImage>
</ClassificationGroup>
</ClassificationGroup>
```

## APPENDIX L – Clubfoot configuration XML

```
        </ImageItemNumericvalue>

        <ImageItemNumericvalue>
          <ImagePath>eh3.jpg</ImagePath>
          <Value>1</Value>
        </ImageItemNumericvalue>

      </ClassificationItemImage>

    </ClassificationGroup>

  </Classification>

</Step>

<Step Id="pirani_right_foot" Static="false">

  <Title>Pirani scoring, right foot</Title>
  <Description>Pirani scoring</Description>

  <NextStep>
    <Condition>Patient.GetAgeInMonths(Encounter.Date) > 24 AND
    GetGroupScoreClassification("pirani_right_foot", "midfoot") <= 0.5 AND
    GetGroupScoreClassification("pirani_right_foot", "hindfoot") > 0</Condition>
    <StepID>surgery_available</StepID>
  </NextStep>

  <NextStep>
    <Condition>>true</Condition>
    <StepID>recommendations</StepID>
  </NextStep>

  <Classification>
    <ClassificationGroup>
      <Title>Midfoot</Title>

      <ClassificationItemImage Id="curved_lateral_border">
        <Title>Curved lateral border</Title>
        <Description>Curved lateral border - description</Description>

        <ImageItemNumericvalue>
          <ImagePath>cla1.jpg</ImagePath>
          <Value>0</Value>
        </ImageItemNumericvalue>

        <ImageItemNumericvalue>
          <ImagePath>cla2.jpg</ImagePath>
          <Value>0.5</Value>
        </ImageItemNumericvalue>

        <ImageItemNumericvalue>
          <ImagePath>cla3.jpg</ImagePath>
          <Value>1</Value>
        </ImageItemNumericvalue>

      </ClassificationItemImage>

      <ClassificationItemImage Id="medial_crease">
        <Title>Medial crease</Title>
        <Description>Medial crease - description</Description>

        <ImageItemNumericvalue>
          <ImagePath>mc1.jpg</ImagePath>
          <Value>0</Value>
        </ImageItemNumericvalue>

        <ImageItemNumericvalue>
          <ImagePath>mc2.jpg</ImagePath>
          <Value>0.5</Value>
        </ImageItemNumericvalue>

        <ImageItemNumericvalue>
          <ImagePath>mc3.jpg</ImagePath>
          <Value>1</Value>
        </ImageItemNumericvalue>

      </ClassificationItemImage>

    </ClassificationGroup>
  </Classification>
</Step>
```



## APPENDIX L – Clubfoot configuration XML

```
</ClassificationItemImage>
<ClassificationItemImage Id="talar_head_coverage">
  <Title>Talar head coverage</Title>
  <Description>Talar head coverage - description</Description>
  <ImageItemNumericvalue>
    <ImagePath>thc1.jpg</ImagePath>
    <Value>0</Value>
  </ImageItemNumericvalue>
  <ImageItemNumericvalue>
    <ImagePath>thc2.jpg</ImagePath>
    <Value>0.5</Value>
  </ImageItemNumericvalue>
  <ImageItemNumericvalue>
    <ImagePath>thc3.jpg</ImagePath>
    <Value>1</Value>
  </ImageItemNumericvalue>
</ClassificationItemImage>
</ClassificationGroup>
<ClassificationGroup>
  <Title>Hindfoot</Title>
  <ClassificationItemImage Id="posterior_crease">
    <Title>Posterior crease</Title>
    <Description>Posterior crease - description</Description>
    <ImageItemNumericvalue>
      <ImagePath>pc1.jpg</ImagePath>
      <Value>0</Value>
    </ImageItemNumericvalue>
    <ImageItemNumericvalue>
      <ImagePath>pc2.jpg</ImagePath>
      <Value>0.5</Value>
    </ImageItemNumericvalue>
    <ImageItemNumericvalue>
      <ImagePath>pc3.jpg</ImagePath>
      <Value>1</Value>
    </ImageItemNumericvalue>
  </ClassificationItemImage>
  <ClassificationItemImage Id="rigid_equinus">
    <Title>Rigid equinus</Title>
    <Description>Rigid equinus - description</Description>
    <ImageItemNumericvalue>
      <ImagePath>re1.jpg</ImagePath>
      <Value>0</Value>
    </ImageItemNumericvalue>
    <ImageItemNumericvalue>
      <ImagePath>re2.jpg</ImagePath>
      <Value>0.5</Value>
    </ImageItemNumericvalue>
    <ImageItemNumericvalue>
      <ImagePath>re3.jpg</ImagePath>
      <Value>1</Value>
    </ImageItemNumericvalue>
  </ClassificationItemImage>
  <ClassificationItemImage Id="empty_heel">
    <Title>Empty heel</Title>
    <Description>Empty heel</Description>
```

## APPENDIX L – Clubfoot configuration XML

```

        <ImageItemNumericvalue>
            <ImagePath>eh1.jpg</ImagePath>
            <Value>0</Value>
        </ImageItemNumericvalue>

        <ImageItemNumericvalue>
            <ImagePath>eh2.jpg</ImagePath>
            <Value>0.5</Value>
        </ImageItemNumericvalue>

        <ImageItemNumericvalue>
            <ImagePath>eh3.jpg</ImagePath>
            <Value>1</Value>
        </ImageItemNumericvalue>

    </ClassificationItemImage>

</ClassificationGroup>

</Classification>

</Step>

<Step Id="surgery_available" Static="false">
    <Title>Surgery available?</Title>
    <Description>Check whether surgery is available</Description>

    <NextStep>
        <Condition>>true</Condition>
        <StepID>recommendations</StepID>
    </NextStep>

    <DataForm>
        <Field Id="surgery" Mandatory="yes">
            <Title>Is surgery available?</Title>
            <Boolean>
                <True>yes</True>
                <False>no</False>
            </Boolean>
        </Field>
    </DataForm>
</Step>

<Step Id="recommendations" Static="false">
    <Title>Recommendations</Title>
    <Description>Recommendations</Description>

    <NextStep>
        <Condition>NumberOfActions("right_cast") = 1</Condition>
        <StepID>control_questions_cast_applied</StepID>
    </NextStep>

    <RecommendationSet>

        <Node>

<Condition>Encounter.GetStep("clinical_static_information").GetStringValueOfField("side_affected") = "Bilateral" OR
Encounter.GetStep("clinical_static_information").GetStringValueOfField("side_affected") = "Right"</Condition>

        <Node>
            <Condition>Patient.GetAgeInMonths(Encounter.Date) &lt;=
24</Condition>

        <Node>
            <Condition>GetTotalScoreClassification("pirani_right_foot") =
0 AND Treatment.ActionNotPerformed("right_orthosis") AND
Treatment.ActionNotPerformed("right_att")</Condition>
            <Statement>
                <Recommendation Id="recommendation1">
                    <ActionID>right_orthosis</ActionID>
                </Recommendation>
            </Statement>
        </Node>
    </Node>
</RecommendationSet>

```

## APPENDIX L – Clubfoot configuration XML

```

        <Condition>GetGroupScoreClassification("pirani_right_foot",
"midfoot") = 0 AND GetGroupScoreClassification("pirani_right_foot", "hindfoot") >
0</Condition>
        <Node>
            <Condition>Patient.GetAgeInMonths(Encounter.Date) &lt;=
18</Condition>
                <Statement>
                    <Recommendation Id="recommendation2">
                        <ActionID>right_tenotomy</ActionID>
                    </Recommendation>
                </Statement>
                <Statement>
                    <Recommendation Id="recommendation3">
                        <ActionID>right_cast3w</ActionID>
                    </Recommendation>
                </Statement>
                <Statement>
                    <Recommendation Id="recommendation4">
                        <ActionID>right_order_orthosis</ActionID>
                    </Recommendation>
                </Statement>
            </Node>
        </Node>
        <Node>
            <Condition>Patient.GetAgeInMonths(Encounter.Date) >
18</Condition>
                <Statement>
                    <Recommendation Id="recommendation5">
                        <ActionID>right_tenotomy</ActionID>
                    </Recommendation>
                </Statement>
                <Statement>
                    <Recommendation Id="recommendation6">
                        <ActionID>right_cast4w</ActionID>
                    </Recommendation>
                </Statement>
                <Statement>
                    <Recommendation Id="recommendation7">
                        <ActionID>right_order_orthosis</ActionID>
                    </Recommendation>
                </Statement>
            </Node>
        </Node>
        <Node>
            <Condition>GetGroupScoreClassification("pirani_right_foot",
"midfoot") > 0</Condition>
                <Statement>
                    <Recommendation Id="recommendation8">
                        <ActionID>right_cast</ActionID>
                    </Recommendation>
                </Statement>
            </Node>
        </Node>
        <Node>
            <Condition>Patient.GetAgeInMonths(Encounter.Date) >
24</Condition>
                <Node>
                    <Condition>GetTotalScoreClassification("pirani_right_foot") =
0 AND Treatment.ActionNotPerformed("right_orthosis") AND
Treatment.ActionNotPerformed("right_att")</Condition>
                        <Statement>
                            <Recommendation Id="recommendation9">
                                <ActionID>right_orthosis</ActionID>
                            </Recommendation>
                        </Statement>
                    </Node>
                </Node>
                <Node>
                    <Condition>GetGroupScoreClassification("pirani_right_foot",
"midfoot") &lt;= 0.5 AND GetGroupScoreClassification("pirani_right_foot", "hindfoot")
> 0</Condition>
                        <Node>
                            <Condition>Encounter.GetStep("surgery_available").GetStringValueOfField("surgery") =
"no"</Condition>
                                <Statement>
                                    <Recommendation Id="recommendation10">
                                        <ActionID>right_tenotomy</ActionID>
                                    </Statement>
                                </Node>
                            </Node>
                        </Node>
                    </Node>
                </Node>
            </Node>
        </Node>
    
```

## APPENDIX L – Clubfoot configuration XML

```

        </Recommendation>
    </Statement>
    <Statement>
        <Recommendation Id="recommendation11">
            <ActionID>right_cast5w</ActionID>
        </Recommendation>
    </Statement>
    <Statement>
        <Recommendation Id="recommendation12">
            <ActionID>right_order_orthosis</ActionID>
        </Recommendation>
    </Statement>
</Node>
<Node>
    <Condition>Encounter.GetStep("surgery_available").GetStringValueOfField("surgery") =
    "yes"</Condition>
        <Statement>
            <Recommendation Id="recommendation13">
                <ActionID>right_tenotomy</ActionID>
            </Recommendation>
        </Statement>
        <Statement>
            <Recommendation Id="recommendation14">
                <ActionID>right_att</ActionID>
            </Recommendation>
        </Statement>
        <Statement>
            <Recommendation Id="recommendation15">
                <ActionID>right_cast5w</ActionID>
            </Recommendation>
        </Statement>
    </Node>
</Node>
<Node>
    <Condition>GetGroupScoreClassification("pirani_right_foot",
    "midfoot") > 0.5</Condition>
        <Statement>
            <Recommendation Id="recommendation16">
                <ActionID>right_cast</ActionID>
            </Recommendation>
        </Statement>
    </Node>
</Node>

    <Node>
        <Condition>Encounter.GetStep("clinical_static_information").GetStringValueOfField("clu
        bfoot_type") = "Idiopathic clubfoot"</Condition>
        <Node>
            <Condition>Patient.GetAgeInMonths(Encounter.Date) <lt;=
            6</Condition>
                <Node>
                    <Condition>Treatment.NumberOfActions("right_cast") >= 5
                    AND Treatment.NumberOfActions("right_cast") <lt;= 6</Condition>
                        <Statement>
                            <Warning Id="1">
                                <Message>Warning! Check treatment of right
                                foot.</Message>
                            </Warning>
                        </Statement>
                    </Node>
                <Node>
                    <Condition>Treatment.NumberOfActions("right_cast") >=
                    6</Condition>
                        <Statement>
                            <Error Id="2">
                                <Message>ERROR! Check treatment of right
                                foot.</Message>
                            </Error>
                        </Statement>
                    </Node>
                </Node>
            </Node>
        </Node>
    </Node>

```

## APPENDIX L – Clubfoot configuration XML

```

        <Condition>Patient.GetAgeInMonths(Encounter.Date) &gt; 6 AND
Patient.GetAgeInMonths(Encounter.Date) &lt;= 12</Condition>

        <Node>
            <Condition>Treatment.NumberOfActions("right_cast") &gt;= 6
AND Treatment.NumberOfActions("right_cast") &lt;= 8</Condition>
            <Statement>
                <Warning Id="3">
                    <Message>Warning! Check treatment of right
foot.</Message>
                </Warning>
            </Statement>
        </Node>
        <Node>
            <Condition>Treatment.NumberOfActions("right_cast") &gt;
8</Condition>
            <Statement>
                <Error Id="4">
                    <Message>ERROR! Check treatment of right
foot.</Message>
                </Error>
            </Statement>
        </Node>
    </Node>
    <Node>
        <Condition>Patient.GetAgeInMonths(Encounter.Date) &gt; 12 AND
Patient.GetAgeInMonths(Encounter.Date) &lt;= 24</Condition>

        <Node>
            <Condition>Treatment.NumberOfActions("right_cast") &gt;= 8
AND Treatment.NumberOfActions("right_cast") &lt;= 10</Condition>
            <Statement>
                <Warning Id="5">
                    <Message>Warning! Check treatment of right
foot.</Message>
                </Warning>
            </Statement>
        </Node>
        <Node>
            <Condition>Treatment.NumberOfActions("right_cast") &gt;
10</Condition>
            <Statement>
                <Error Id="6">
                    <Message>ERROR! Check treatment of right
foot.</Message>
                </Error>
            </Statement>
        </Node>
    </Node>
</Node>

    <Node>
        <Condition>Encounter.GetStep("clinical_static_information").GetStringValueOfField("clu
bfoot_type") = "Neglected clubfoot"</Condition>

        <Node>
            <Condition>Treatment.NumberOfActions("right_cast") &gt;= 9 AND
Treatment.NumberOfActions("right_cast") &lt;= 12</Condition>
            <Statement>
                <Warning Id="7">
                    <Message>Warning! Check treatment of right
foot.</Message>
                </Warning>
            </Statement>
        </Node>
        <Node>
            <Condition>Treatment.NumberOfActions("right_cast") &gt;
12</Condition>
            <Statement>
                <Error Id="8">
                    <Message>ERROR! Check treatment of right
foot.</Message>
                </Error>
            </Statement>
        </Node>
    </Node>

```

## APPENDIX L – Clubfoot configuration XML

```

        </Statement>
    </Node>

</Node>

<Node>
<Condition>Encounter.GetStep("clinical_static_information").GetStringValueOfField("clubfoot_type") = "Recurrent clubfoot"</Condition>
    <Node>
        <Condition>Patient.GetAgeInMonths(Encounter.Date) &lt;=
24</Condition>
        <Node>
            <Condition>Treatment.NumberOfActions("right_cast") &gt;= 4
AND Treatment.NumberOfActions("right_cast") &lt;= 6</Condition>
            <Statement>
                <Warning Id="9">
                    <Message>Warning! Check treatment of right
foot.</Message>
                </Warning>
            </Statement>
        </Node>
        <Node>
            <Condition>Treatment.NumberOfActions("right_cast") &gt;
6</Condition>
            <Statement>
                <Error Id="10">
                    <Message>ERROR! Check treatment of right
foot.</Message>
                </Error>
            </Statement>
        </Node>
    </Node>
    <Node>
        <Condition>Patient.GetAgeInMonths(Encounter.Date) &gt;
24</Condition>
        <Node>
            <Condition>Treatment.NumberOfActions("right_cast") &gt;= 5
AND Treatment.NumberOfActions("right_cast") &lt;= 7</Condition>
            <Statement>
                <Warning Id="11">
                    <Message>Warning! Check treatment of right
foot.</Message>
                </Warning>
            </Statement>
        </Node>
        <Node>
            <Condition>Treatment.NumberOfActions("right_cast") &gt;
7</Condition>
            <Statement>
                <Error Id="12">
                    <Message>ERROR! Check treatment of right
foot.</Message>
                </Error>
            </Statement>
        </Node>
    </Node>
</Node>

<Node>
<Condition>Encounter.GetStep("clinical_static_information").GetStringValueOfField("clubfoot_type") = "Complex clubfoot"</Condition>
    <Node>
        <Condition>Patient.GetAgeInMonths(Encounter.Date) &lt;=
6</Condition>
        <Node>
            <Condition>Treatment.NumberOfActions("right_cast") &gt;=
11 AND Treatment.NumberOfActions("right_cast") &lt;= 12</Condition>
            <Statement>

```

## APPENDIX L – Clubfoot configuration XML

```

        <Warning Id="13">
            <Message>Warning! Check treatment of right
foot.</Message>
        </Warning>
    </Statement>
</Node>
<Node>
    <Condition>Treatment.NumberOfActions("right_cast") &gt;
12</Condition>
    <Statement>
        <Error Id="14">
            <Message>ERROR! Check treatment of right
foot.</Message>
        </Error>
    </Statement>
</Node>
</Node>
<Node>
    <Condition>Patient.GetAgeInMonths(Encounter.Date) &gt; 6 AND
Patient.GetAgeInMonths(Encounter.Date) &lt;= 12</Condition>
    <Node>
        <Condition>Treatment.NumberOfActions("right_cast") &gt;=
11 AND Treatment.NumberOfActions("right_cast") &lt;= 14</Condition>
        <Statement>
            <Warning Id="15">
                <Message>Warning! Check treatment of right
foot.</Message>
            </Warning>
        </Statement>
</Node>
<Node>
    <Condition>Treatment.NumberOfActions("right_cast") &gt;
14</Condition>
    <Statement>
        <Error Id="16">
            <Message>ERROR! Check treatment of right
foot.</Message>
        </Error>
    </Statement>
</Node>
</Node>
<Node>
    <Condition>Patient.GetAgeInMonths(Encounter.Date) &gt; 12 AND
Patient.GetAgeInMonths(Encounter.Date) &lt;= 24</Condition>
    <Node>
        <Condition>Treatment.NumberOfActions("right_cast") &gt;=
11 AND Treatment.NumberOfActions("right_cast") &lt;= 15</Condition>
        <Statement>
            <Warning Id="17">
                <Message>Warning! Check treatment of right
foot.</Message>
            </Warning>
        </Statement>
</Node>
<Node>
    <Condition>Treatment.NumberOfActions("right_cast") &gt;
15</Condition>
    <Statement>
        <Error Id="18">
            <Message>ERROR! Check treatment of right
foot.</Message>
        </Error>
    </Statement>
</Node>
</Node>
<Node>
    <Condition>Patient.GetAgeInMonths(Encounter.Date) &gt;
24</Condition>
    <Node>
        <Condition>Treatment.NumberOfActions("right_cast") &gt;=
11 AND Treatment.NumberOfActions("right_cast") &lt;= 15</Condition>

```

## APPENDIX L – Clubfoot configuration XML

```

        <Statement>
            <Warning Id="19">
                <Message>Warning! Check treatment of right
foot.</Message>
            </Warning>
        </Statement>
    </Node>
    <Node>
        <Condition>Treatment.NumberOfActions("right_cast") &gt;
15</Condition>
        <Statement>
            <Error Id="20">
                <Message>ERROR! Check treatment of right
foot.</Message>
            </Error>
        </Statement>
    </Node>
</Node>
</Node>
    <Node>
<Condition>Encounter.GetStep("clinical_static_information").GetStringValueOfField("syn
dromic_type") = "Arthrogryposis"</Condition>
    <Node>
        <Condition>Patient.GetAgeInMonths(Encounter.Date) &lt;=
12</Condition>
        <Node>
            <Condition>Treatment.NumberOfActions("right_cast") &gt;= 9
AND Treatment.NumberOfActions("right_cast") &lt;= 10</Condition>
            <Statement>
                <Warning Id="21">
                    <Message>Warning! Check treatment of right
foot.</Message>
                </Warning>
            </Statement>
        </Node>
    <Node>
        <Condition>Treatment.NumberOfActions("right_cast") &gt;
10</Condition>
        <Statement>
            <Error Id="22">
                <Message>ERROR! Check treatment of right
foot.</Message>
            </Error>
        </Statement>
    </Node>
</Node>
    <Node>
        <Condition>Patient.GetAgeInMonths(Encounter.Date) &gt; 12 AND
Patient.GetAgeInMonths(Encounter.Date) &lt;= 24</Condition>
        <Node>
            <Condition>Treatment.NumberOfActions("right_cast") &gt;=
11 AND Treatment.NumberOfActions("right_cast") &lt;= 12</Condition>
            <Statement>
                <Warning Id="23">
                    <Message>Warning! Check treatment of right
foot.</Message>
                </Warning>
            </Statement>
        </Node>
    <Node>
        <Condition>Treatment.NumberOfActions("right_cast") &gt;
12</Condition>
        <Statement>
            <Error Id="24">
                <Message>ERROR! Check treatment of right
foot.</Message>
            </Error>
        </Statement>
    </Node>

```



## APPENDIX L – Clubfoot configuration XML

```

        </Node>
        <Node>
            <Condition>Patient.GetAgeInMonths(Encounter.Date) &gt;
24</Condition>

            <Node>
                <Condition>Treatment.NumberOfActions("right_cast") &gt;=
11 AND Treatment.NumberOfActions("right_cast") &lt;= 14</Condition>
                <Statement>
                    <Warning Id="25">
                        <Message>Warning! Check treatment of right
foot.</Message>
                    </Warning>
                </Statement>
            </Node>
            <Node>
                <Condition>Treatment.NumberOfActions("right_cast") &gt;
14</Condition>
                <Statement>
                    <Error Id="26">
                        <Message>ERROR! Check treatment of right
foot.</Message>
                    </Error>
                </Statement>
            </Node>
        </Node>
    </Node>

    <Node>
        <Condition>Encounter.GetStep("clinical_static_information").GetStringValueOfField("side_affected") = "Bilateral" OR
Encounter.GetStep("clinical_static_information").GetStringValueOfField("side_affected") = "Left"</Condition>

        <Node>
            <Condition>Patient.GetAgeInMonths(Encounter.Date) &lt;=
24</Condition>

            <Node>
                <Condition>GetTotalScoreClassification("pirani_left_foot") = 0
AND Treatment.ActionNotPerformed("left_orthosis") AND
Treatment.ActionNotPerformed("left_att")</Condition>
                <Statement>
                    <Recommendation Id="recommendation17">
                        <ActionID>left_orthosis</ActionID>
                    </Recommendation>
                </Statement>
            </Node>
            <Node>
                <Condition>GetGroupScoreClassification("pirani_left_foot",
"midfoot") = 0 AND GetGroupScoreClassification("pirani_left_foot", "hindfoot") &gt;
0</Condition>

                <Node>
                    <Condition>Patient.GetAgeInMonths(Encounter.Date) &lt;=
18</Condition>

                    <Statement>
                        <Recommendation Id="recommendation18">
                            <ActionID>left_tenotomy</ActionID>
                        </Recommendation>
                    </Statement>
                    <Statement>
                        <Recommendation Id="recommendation19">
                            <ActionID>left_cast3w</ActionID>
                        </Recommendation>
                    </Statement>
                    <Statement>
                        <Recommendation Id="recommendation20">
                            <ActionID>left_order_orthosis</ActionID>
                        </Recommendation>
                    </Statement>
                </Node>
            </Node>
            <Condition>Patient.GetAgeInMonths(Encounter.Date) &gt;
18</Condition>

```

## APPENDIX L – Clubfoot configuration XML

```

        <Statement>
            <Recommendation Id="recommendation21">
                <ActionID>left_tenotomy</ActionID>
            </Recommendation>
        </Statement>
        <Statement>
            <Recommendation Id="recommendation22">
                <ActionID>left_cast4w</ActionID>
            </Recommendation>
        </Statement>
        <Statement>
            <Recommendation Id="recommendation23">
                <ActionID>left_orthosis</ActionID>
            </Recommendation>
        </Statement>
    </Node>
</Node>
<Node>
    <Condition>GetGroupScoreClassification("pirani_left_foot",
"midfoot") > 0</Condition>
    <Statement>
        <Recommendation Id="recommendation24">
            <ActionID>left_cast</ActionID>
        </Recommendation>
    </Statement>
</Node>
</Node>
<Node>
    <Condition>Patient.GetAgeInMonths(Encounter.Date) >
24</Condition>
    <Node>
        <Condition>GetTotalScoreClassification("pirani_left_foot") = 0
AND Treatment.ActionNotPerformed("left_orthosis") AND
Treatment.ActionNotPerformed("left_att")</Condition>
        <Statement>
            <Recommendation Id="recommendation25">
                <ActionID>left_orthosis</ActionID>
            </Recommendation>
        </Statement>
    </Node>
</Node>
<Node>
    <Condition>GetGroupScoreClassification("pirani_left_foot",
"midfoot") <= 0.5 AND GetGroupScoreClassification("pirani_left_foot", "hindfoot")
> 0</Condition>
    <Node>
        <Condition>Encounter.GetStep("surgery_available").GetStringValueOfField("surgery") =
"no"</Condition>
        <Statement>
            <Recommendation Id="recommendation26">
                <ActionID>left_tenotomy</ActionID>
            </Recommendation>
        </Statement>
        <Statement>
            <Recommendation Id="recommendation27">
                <ActionID>left_cast5w</ActionID>
            </Recommendation>
        </Statement>
        <Statement>
            <Recommendation Id="recommendation28">
                <ActionID>left_orthosis</ActionID>
            </Recommendation>
        </Statement>
    </Node>
</Node>
<Condition>Encounter.GetStep("surgery_available").GetStringValueOfField("surgery") =
"yes"</Condition>
    <Statement>
        <Recommendation Id="recommendation29">
            <ActionID>left_tenotomy</ActionID>
        </Recommendation>
    </Statement>
    <Statement>
        <Recommendation Id="recommendation30">
            <ActionID>left_att</ActionID>
        </Recommendation>
    </Statement>

```

## APPENDIX L – Clubfoot configuration XML

```

        </Recommendation>
    </Statement>
    <Statement>
        <Recommendation Id="recommendation31">
            <ActionID>left_cast5w</ActionID>
        </Recommendation>
    </Statement>
</Node>
</Node>
<Node>
    <Condition>GetGroupScoreClassification("pirani_left_foot",
"midfoot") &gt; 0.5</Condition>
    <Statement>
        <Recommendation Id="recommendation32">
            <ActionID>left_cast</ActionID>
        </Recommendation>
    </Statement>
</Node>
</Node>

<Node>
<Condition>Encounter.GetStep("clinical_static_information").GetStringValueOfField("clu
bfoot_type") = "Idiopathic clubfoot"</Condition>
    <Node>
        <Condition>Patient.GetAgeInMonths(Encounter.Date) &lt;=
6</Condition>

        <Node>
            <Condition>Treatment.NumberOfActions("left_cast") &gt;= 5
AND Treatment.NumberOfActions("left_cast") &lt;= 6</Condition>
            <Statement>
                <Warning Id="27">
                    <Message>Warning! Check treatment of left
foot.</Message>
                </Warning>
            </Statement>
        </Node>
        <Node>
            <Condition>Treatment.NumberOfActions("left_cast") &gt;
6</Condition>
            <Statement>
                <Error Id="28">
                    <Message>ERROR! Check treatment of left
foot.</Message>
                </Error>
            </Statement>
        </Node>
    </Node>
    <Node>
        <Condition>Patient.GetAgeInMonths(Encounter.Date) &gt; 6 AND
Patient.GetAgeInMonths(Encounter.Date) &lt;= 12</Condition>

        <Node>
            <Condition>Treatment.NumberOfActions("left_cast") &gt;= 6
AND Treatment.NumberOfActions("left_cast") &lt;= 8</Condition>
            <Statement>
                <Warning Id="29">
                    <Message>Warning! Check treatment of left
foot.</Message>
                </Warning>
            </Statement>
        </Node>
        <Node>
            <Condition>Treatment.NumberOfActions("left_cast") &gt;
8</Condition>
            <Statement>
                <Error Id="30">
                    <Message>ERROR! Check treatment of left
foot.</Message>
                </Error>
            </Statement>
        </Node>
    </Node>
</Node>

```

## APPENDIX L – Clubfoot configuration XML

```

        <Node>
            <Condition>Patient.GetAgeInMonths(Encounter.Date) &gt; 12 AND
Patient.GetAgeInMonths(Encounter.Date) &lt;= 24</Condition>

            <Node>
                <Condition>Treatment.NumberOfActions("left_cast") &gt;= 8
AND Treatment.NumberOfActions("left_cast") &lt;= 10</Condition>
                <Statement>
                    <Warning Id="31">
                        <Message>Warning! Check treatment of left
foot.</Message>
                    </Warning>
                </Statement>
            </Node>
            <Node>
                <Condition>Treatment.NumberOfActions("left_cast") &gt;
10</Condition>
                <Statement>
                    <Error Id="32">
                        <Message>ERROR! Check treatment of left
foot.</Message>
                    </Error>
                </Statement>
            </Node>
        </Node>
    </Node>

    <Node>
        <Condition>Encounter.GetStep("clinical_static_information").GetStringValueOfField("clu
bfoot_type") = "Neglected clubfoot"</Condition>

        <Node>
            <Condition>Treatment.NumberOfActions("left_cast") &gt;= 9 AND
Treatment.NumberOfActions("left_cast") &lt;= 12</Condition>
            <Statement>
                <Warning Id="33">
                    <Message>Warning! Check treatment of left
foot.</Message>
                </Warning>
            </Statement>
        </Node>
        <Node>
            <Condition>Treatment.NumberOfActions("left_cast") &gt;
12</Condition>
            <Statement>
                <Error Id="34">
                    <Message>ERROR! Check treatment of left
foot.</Message>
                </Error>
            </Statement>
        </Node>
    </Node>

    <Node>
        <Condition>Encounter.GetStep("clinical_static_information").GetStringValueOfField("clu
bfoot_type") = "Recurrent clubfoot"</Condition>
        <Node>
            <Condition>Patient.GetAgeInMonths(Encounter.Date) &lt;=
24</Condition>

            <Node>
                <Condition>Treatment.NumberOfActions("left_cast") &gt;= 4
AND Treatment.NumberOfActions("left_cast") &lt;= 6</Condition>
                <Statement>
                    <Warning Id="35">
                        <Message>Warning! Check treatment of left
foot.</Message>
                    </Warning>
                </Statement>
            </Node>
        </Node>
    </Node>

```

## APPENDIX L – Clubfoot configuration XML

```

        <Condition>Treatment.NumberOfActions("left_cast") &gt;
6</Condition>
        <Statement>
            <Error Id="36">
                <Message>ERROR! Check treatment of left
foot.</Message>
            </Error>
        </Statement>
    </Node>
</Node>
<Node>
    <Condition>Patient.GetAgeInMonths(Encounter.Date) &gt;
24</Condition>
    <Node>
        <Condition>Treatment.NumberOfActions("left_cast") &gt;= 5
AND Treatment.NumberOfActions("left_cast") &lt;= 7</Condition>
        <Statement>
            <Warning Id="37">
                <Message>Warning! Check treatment of left
foot.</Message>
            </Warning>
        </Statement>
    </Node>
<Node>
    <Condition>Treatment.NumberOfActions("left_cast") &gt;
7</Condition>
    <Statement>
        <Error Id="38">
            <Message>ERROR! Check treatment of left
foot.</Message>
        </Error>
    </Statement>
</Node>
</Node>
<Node>
    <Condition>Encounter.GetStep("clinical_static_information").GetStringValueOfField("clubfoot_type") = "Complex clubfoot"</Condition>
    <Node>
        <Condition>Patient.GetAgeInMonths(Encounter.Date) &lt;=
6</Condition>
        <Node>
            <Condition>Treatment.NumberOfActions("left_cast") &gt;= 11
AND Treatment.NumberOfActions("left_cast") &lt;= 12</Condition>
            <Statement>
                <Warning Id="39">
                    <Message>Warning! Check treatment of left
foot.</Message>
                </Warning>
            </Statement>
        </Node>
<Node>
            <Condition>Treatment.NumberOfActions("left_cast") &gt;
12</Condition>
            <Statement>
                <Error Id="40">
                    <Message>ERROR! Check treatment of left
foot.</Message>
                </Error>
            </Statement>
        </Node>
    </Node>
<Node>
    <Condition>Patient.GetAgeInMonths(Encounter.Date) &gt; 6 AND
Patient.GetAgeInMonths(Encounter.Date) &lt;= 12</Condition>
    <Node>
        <Condition>Treatment.NumberOfActions("left_cast") &gt;= 11
AND Treatment.NumberOfActions("left_cast") &lt;= 14</Condition>

```

## APPENDIX L – Clubfoot configuration XML

```

        <Statement>
          <Warning Id="41">
            <Message>Warning! Check treatment of left
foot.</Message>
          </Warning>
        </Statement>
      </Node>
    <Node>
      <Condition>Treatment.NumberOfActions("left_cast") &gt;
14</Condition>
      <Statement>
        <Error Id="42">
          <Message>ERROR! Check treatment of left
foot.</Message>
        </Error>
      </Statement>
    </Node>
  </Node>
  <Node>
    <Condition>Patient.GetAgeInMonths(Encounter.Date) &gt; 12 AND
Patient.GetAgeInMonths(Encounter.Date) &lt;= 24</Condition>
    <Node>
      <Condition>Treatment.NumberOfActions("left_cast") &gt;= 11
AND Treatment.NumberOfActions("left_cast") &lt;= 15</Condition>
      <Statement>
        <Warning Id="43">
          <Message>Warning! Check treatment of left
foot.</Message>
        </Warning>
      </Statement>
    </Node>
    <Node>
      <Condition>Treatment.NumberOfActions("left_cast") &gt;
15</Condition>
      <Statement>
        <Error Id="44">
          <Message>ERROR! Check treatment of left
foot.</Message>
        </Error>
      </Statement>
    </Node>
  </Node>
  <Node>
    <Condition>Patient.GetAgeInMonths(Encounter.Date) &gt;
24</Condition>
    <Node>
      <Condition>Treatment.NumberOfActions("left_cast") &gt;= 11
AND Treatment.NumberOfActions("left_cast") &lt;= 15</Condition>
      <Statement>
        <Warning Id="45">
          <Message>Warning! Check treatment of left
foot.</Message>
        </Warning>
      </Statement>
    </Node>
    <Node>
      <Condition>Treatment.NumberOfActions("left_cast") &gt;
15</Condition>
      <Statement>
        <Error Id="46">
          <Message>ERROR! Check treatment of left
foot.</Message>
        </Error>
      </Statement>
    </Node>
  </Node>
</Node>
</Node>
<Node>

```

## APPENDIX L – Clubfoot configuration XML

```

<Condition>Encounter.GetStep("clinical_static_information").GetStringValueOfField("syn
dromic_type") = "Arthrogyposis"</Condition>
  <Node>
    <Condition>Patient.GetAgeInMonths(Encounter.Date) &lt;=
12</Condition>
    <Node>
      <Condition>Treatment.NumberOfActions("left_cast") &gt;= 9
AND Treatment.NumberOfActions("left_cast") &lt;= 10</Condition>
      <Statement>
        <Warning Id="47">
          <Message>Warning! Check treatment of left
foot.</Message>
        </Warning>
      </Statement>
    </Node>
    <Node>
      <Condition>Treatment.NumberOfActions("left_cast") &gt;
10</Condition>
      <Statement>
        <Error Id="48">
          <Message>ERROR! Check treatment of left
foot.</Message>
        </Error>
      </Statement>
    </Node>
  </Node>
  <Node>
    <Condition>Patient.GetAgeInMonths(Encounter.Date) &gt; 12 AND
Patient.GetAgeInMonths(Encounter.Date) &lt;= 24</Condition>
    <Node>
      <Condition>Treatment.NumberOfActions("left_cast") &gt;= 11
AND Treatment.NumberOfActions("left_cast") &lt;= 12</Condition>
      <Statement>
        <Warning Id="49">
          <Message>Warning! Check treatment of left
foot.</Message>
        </Warning>
      </Statement>
    </Node>
    <Node>
      <Condition>Treatment.NumberOfActions("left_cast") &gt;
12</Condition>
      <Statement>
        <Error Id="50">
          <Message>ERROR! Check treatment of left
foot.</Message>
        </Error>
      </Statement>
    </Node>
  </Node>
  <Node>
    <Condition>Patient.GetAgeInMonths(Encounter.Date) &gt;
24</Condition>
    <Node>
      <Condition>Treatment.NumberOfActions("left_cast") &gt;= 11
AND Treatment.NumberOfActions("left_cast") &lt;= 14</Condition>
      <Statement>
        <Warning Id="51">
          <Message>Warning! Check treatment of left
foot.</Message>
        </Warning>
      </Statement>
    </Node>
    <Node>
      <Condition>Treatment.NumberOfActions("left_cast") &gt;
14</Condition>
      <Statement>
        <Error Id="52">
          <Message>ERROR! Check treatment of left
foot.</Message>
        </Error>
      </Statement>
    </Node>
  </Node>

```

## APPENDIX L – Clubfoot configuration XML

```
        </Statement>
      </Node>

    </Node>
  </Node>

</RecommendationSet>

</Step>

<Step Id="control_questions_cast_applied" Static="false">
  <Title>Control questions when cast has been applied</Title>
  <Description>Control questions when cast has been applied</Description>

  <DataForm>
    <Group>
      <Title>Right foot</Title>

      <Field Id="right_foot_is_the_cast_moulded_above_the_heel">
        <Title>Is the cast moulded above the heel?</Title>
        <Boolean>
          <True>yes</True>
          <False>no</False>
        </Boolean>
      </Field>

      <Field Id="right_foot_is_the_pressure_on_talar_head">
        <Title>Is the pressure on talar head?</Title>
        <Boolean>
          <True>yes</True>
          <False>no</False>
        </Boolean>
      </Field>

      <Field Id="right_foot_is_forefoot_in_flexion_and_supination">
        <Title>Is forefoot in flexion and supination?</Title>
        <Boolean>
          <True>yes</True>
          <False>no</False>
        </Boolean>
      </Field>

      <Field Id="right_foot_is_the_cast_above_the_flexed_knee_90degree">
        <Title>Is the cast above the flexed knee (90degree)?</Title>
        <Boolean>
          <True>yes</True>
          <False>no</False>
        </Boolean>
      </Field>
    </Group>

    <Group>
      <Title>Left foot</Title>

      <Field Id="left_foot_is_the_cast_moulded_above_the_heel">
        <Title>Is the cast moulded above the heel?</Title>
        <Boolean>
          <True>yes</True>
          <False>no</False>
        </Boolean>
      </Field>

      <Field Id="left_foot_is_the_pressure_on_talar_head">
        <Title>Is the pressure on talar head?</Title>
        <Boolean>
          <True>yes</True>
          <False>no</False>
        </Boolean>
      </Field>

      <Field Id="left_foot_is_forefoot_in_flexion_and_supination">
        <Title>Is forefoot in flexion and supination?</Title>
```



## APPENDIX L – Clubfoot configuration XML

```
<Boolean>
  <True>yes</True>
  <False>no</False>
</Boolean>
</Field>

<Field Id="left_foot_is_the_cast_above_the_flexed_knee_90degree">
  <Title>Is the cast above the flexed knee (90degree)?</Title>
  <Boolean>
    <True>yes</True>
    <False>no</False>
  </Boolean>
</Field>

</Group>

</DataForm>
</Step>

</GenSupportConfiguration>
```